

SECTION INDEX Click on any section below to go that portion for a detailed Table of Contents



A. System Overview

B. Bundle

1. Cable Ties
2. Cable Accessories
3. Stainless Steel Cable Ties and Accessories

C. Route/Protect

1. Wiring Duct
2. Surface Raceway
3. Abrasion Protection
4. Cable Management

D. Terminate

1. Terminals
2. Power Connectors
3. Grounding Connectors

HELPFUL LINKS

See bottom of page for other helpful links

E. Identification and Safety Solutions

1. Labeling Systems
2. Labels
3. Pre-Printed and Write-On Markers
4. Permanent Identification
5. Lockout/Tagout and Safety Solutions

F. Part Number Index

CLICK on any of the tabs on this page to jump to that location within the catalog



A. System Overview

B1. Cable Ties

B2. Cable Accessories

B3. Stainless Steel Ties

C1. Wiring Duct

C2. Surface Raceway

C3. Abrasion Protection

C4. Cable Management

D1. Terminals

D2. Power Connectors

D3. Grounding Connectors

E1. Labeling Systems

E2. Labels

E3. Pre-Printed & Write-On Markers

E4. Permanent Identification

E5. Lockout/Tagout & Safety Solutions

F. Index



Click on the logo above to go to www.panduit.com

up to date product information
find a local distributor
technical information

Search

Click above for instructions on how to search for part numbers and other terms in this catalog

Contact Panduit

Click above for contact information worldwide and regional headquarters

HELP!

Click above for helpful user tips on navigating this catalog and technical info about this software

To order a printed catalog, ask for SA-ELCB10
To order a catalog on CD, ask for SA-CPCD08

A.
System
Overview

Table of Contents SA-ELCB10 (replaces SA-ELCB03)

[Click Here for Instruction
on Searching by
Part Number](#)

B1.
Cable Ties

System Overview

System Overview	A1.1
Solutions Overview	A1.2 – A1.3
Control Panel Solutions	A1.4
Harness Solutions	A1.5
Contractor Solutions	A1.6
MRO Solutions	A1.6
Harsh Environment Solutions	A1.7
Transportation Solutions	A1.7
Application Standards	A1.8 – A1.9
Programs	A1.10

C1.
Wiring
Duct

Cable Ties

Cable Ties	B1.1
Cable Tie Selection Chart	B1.2 – B1.3
Cable Tie Styles Overview	B1.4 – B1.5
Features and Benefits – <i>PAN-TY</i> ® Cable Ties	B1.6
Selection Guide – <i>PAN-TY</i> ® Cable Ties	B1.7
<i>PAN-TY</i> ® Cable Ties – Nylon 6.6	B1.8
<i>PAN-TY</i> ® Lashing Ties – Nylon 6.6	B1.9
<i>PAN-TY</i> ® Cable Ties – Weather Resistant Nylon 6.6	B1.10
<i>PAN-TY</i> ® Lashing Ties – Weather Resistant Nylon 6.6	B1.11
<i>PAN-TY</i> ® Cable Ties – Heat Stabilized Nylon 6.6	B1.12
<i>PAN-TY</i> ® Cable Ties – Heat Stabilized Weather Resistant Nylon 6.6	B1.13
<i>PAN-TY</i> ® Cable Ties – Flame Retardant Nylon 6.6	B1.14
Cable Tie Mounts – Flame Retardant Nylon 6.6	B1.14
<i>PAN-TY</i> ® Cable Ties – Weather Resistant Nylon 12	B1.15
<i>PAN-TY</i> ® Cable Ties – Polypropylene – Distinctive Green Color	B1.16
<i>PAN-TY</i> ® Cable Ties – Weather Resistant Polypropylene	B1.17
<i>PAN-TY</i> ® Cable Ties – HALAR▲ – Distinctive Maroon Color	B1.18
<i>PAN-TY</i> ® Cable Ties – TEFZEL■ – Distinctive Aqua Blue Color	B1.19
Cable Tie Mounts – TEFZEL■	B1.19
★ <i>PAN-TY</i> ® Cable Ties – PEEK (Polyetheretherketone)	B1.20
★ <i>PAN-TY</i> ® Cable Ties – Metal Detectable Nylon 6.6	B1.21
<i>PAN-TY</i> ® Releasable Cable Ties – Nylon 6.6	B1.22
<i>PAN-TY</i> ® Releasable Lashing Ties – Nylon 6.6	B1.22
<i>PAN-TY</i> ® Releasable Cable Ties – Weather Resistant and Heat Stabilized Nylon 6.6	B1.23
<i>PAN-TY</i> ® Releasable Lashing Ties – Weather Resistant Nylon 6.6	B1.24
Lashing Tie Mounting Clip – Weather Resistant Nylon 6.6	B1.24
<i>PAN-TY</i> ® Releasable Lashing Ties – Weather Resistant Polypropylene	B1.25
<i>PAN-TY</i> ® Clamp Ties – Nylon 6.6	B1.26
<i>PAN-TY</i> ® Clamp Ties – Weather Resistant and Heat Stabilized Nylon 6.6	B1.27
<i>PAN-TY</i> ® Wing Push Mount Ties – Nylon 6.6	B1.28
<i>PAN-TY</i> ® Wing Push Mount Ties – Weather Resistant and Heat Stabilized Nylon 6.6	B1.29
<i>PAN-TY</i> ® Releasable Wing Push Mount Ties	B1.30
<i>PAN-TY</i> ® Center Mounted Wing Push Mount Ties – Heat Stabilized Nylon 6.6	B1.31
<i>PAN-TY</i> ® Ladder Style Releasable Wing Push Mount Ties – Heat Stabilized Nylon 6.6	B1.32
<i>PAN-TY</i> ® Umbrella Wing Push Mount Ties – Nylon and Heat Stabilized Nylon 6.6	B1.32
<i>PAN-TY</i> ® Push Mount Ties	B1.33
<i>PAN-TY</i> ® Marker and Flag Ties	B1.34
<i>PAN-TY</i> ® Cable Ties Material and Color Chart	B1.35 – B1.37
Features and Benefits – <i>SUPER-GRIP</i> ® Cable Ties	B1.38
Selection Guide – <i>SUPER-GRIP</i> ® Cable Ties	B1.39
<i>SUPER-GRIP</i> ® Cable Ties – Nylon 6.6	B1.40
<i>SUPER-GRIP</i> ® Cable Ties – Weather Resistant and Heat Stabilized Nylon 6.6	B1.41
<i>SUPER-GRIP</i> ® Cable Ties and Mounts Material and Color Chart	B1.42
Features and Benefits – <i>DOME-TOP</i> ® Barb Ty Cable Ties	B1.43
Selection Guide – <i>DOME-TOP</i> ® Barb Ty and <i>DURA-TY</i> ™ Cable Ties	B1.44
<i>DOME-TOP</i> ® Barb Ty Cable Ties – Nylon 6.6	B1.45
<i>DOME-TOP</i> ® Barb Ty Cable Ties – Weather Resistant Nylon 6.6	B1.46
<i>DOME-TOP</i> ® Barb Ty Cable Ties – Heat Stabilized Nylon 6.6	B1.47
<i>DOME-TOP</i> ® Barb Ty Clamp Ties – Nylon 6.6	B1.48
<i>DOME-TOP</i> ® Barb Ty Clamp Ties – Weather Resistant and Heat Stabilized Nylon 6.6	B1.49
<i>DOME-TOP</i> ® Barb Ty Wing Push Mount Ties – Nylon and Weather Resistant Nylon 6.6	B1.50
<i>DOME-TOP</i> ® Barb Ty Push Mount Ties – Weather Resistant Nylon 6.6	B1.51

■ TEFZEL is a registered trademark of E.I. du Pont de Nemours and Company. ▲ HALAR is a registered trademark of Solvay Solexis, Inc.

★ Represents new product offering.

Table of Contents

Permanent Marking Pens	B1.51
<i>DOME-TOP</i> ® Barb Ty Marker and Flag Ties	B1.52
★ <i>DURA-TY</i> ™ Cable Ties – Weather Resistant Acetal – Heavy Cross Section	B1.53
<i>DURA-TY</i> ™ Cable Ties – Weather Resistant Acetal – Extra-Heavy Cross Section	B1.53
Stackable Aerial Cable Spacer – Weather Resistant Polypropylene	B1.54
<i>DOME-TOP</i> ® Barb Ty and <i>DURA-TY</i> ™ Cable Ties Material and Color Chart	B1.54 – B1.55
Features and Benefits – Parallel-Entry Cable Ties	B1.56
Selection Guide – Parallel-Entry Cable Ties	B1.57
<i>CONTOUR-TY</i> ® Cable Ties – Nylon 6.6	B1.58
<i>CONTOUR-TY</i> ® Cable Ties – Weather Resistant Nylon 6.6	B1.59
<i>CONTOUR-TY</i> ® Cable Ties – Heat Stabilized and Flame Retardant Nylon 6.6	B1.60
<i>BELT-TY</i> ™ In-Line Cable Ties – Nylon and Weather Resistant Nylon 6.6	B1.61
★ <i>HYPER-V</i> ™ In-Line Cable Ties – Weather Resistant Nylon 6.6	B1.62
★ <i>HYPER-V</i> ™ Cable Tie Mounts	B1.62
IN-LINE Cable Ties – Weather Resistant Nylon 6.6	B1.63
Parallel-Entry Cable Ties Material and Color Chart	B1.64
Features and Benefits – <i>STA-STRAP</i> ® Cable Ties	B1.65
Selection Guide – <i>STA-STRAP</i> ® Cable Ties	B1.66
<i>STA-STRAP</i> ® Cable Ties – Nylon 6.6	B1.67
<i>STA-STRAP</i> ® Cable Ties – Weather Resistant Nylon 6.6	B1.68
<i>STA-STRAP</i> ® Cable Ties – Heat Stabilized Nylon 6.6	B1.69
<i>STA-STRAP</i> ® Clamp Ties	B1.70
<i>STA-STRAP</i> ® Marker Ties – Nylon and Weather Resistant Nylon 6.6	B1.71
<i>STA-STRAP</i> ® Cable Ties Material and Color Chart	B1.72
Selection Guide – Specialty Ties	B1.73
<i>PAN-TY</i> ® Stud Mounted Cable Ties – Heat Stabilized and Heat Stabilized Weather Resistant Nylon 6.6	B1.74
<i>PAN-TY</i> ® Ladder Style Stud Mounted Cable Tie – Heat Stabilized Nylon 6.6	B1.75
<i>PAN-TY</i> ® Double Loop Cable Ties	B1.76
<i>STA-STRAP</i> ® <i>BOW-TY</i> ™ Cable Ties	B1.77
<i>PAN-TY</i> ® Triple Loop Cable Tie – Weather Resistant Nylon 6.6	B1.78
Double Hose Clamp – Weather Resistant Nylon 6.6	B1.78
<i>STA-STRAP</i> ® Chassis/Panel Mount Tie – Heat Stabilized Weather Resistant Nylon 6.6	B1.79
Cable Marker Straps – Polyethylene	B1.80
Specialty Cable Ties Material and Color Chart	B1.81
<i>PAN-TY</i> ® Striped Cable Ties – Nylon 6.6	B1.82
Telephone Cable Identification Kits	B1.83
Cable Tie Kits in Steel Boxes	B1.83
Cable Tie Kits in Plastic Boxes and Bags	B1.84
Features and Benefits – Hook and Loop Cable Ties	B1.85
Selection Guide – Hook and Loop Cable Ties	B1.86
<i>TAK-TY</i> ® Hook & Loop Cable Ties	B1.87
<i>TAK-TY</i> ® Hook & Loop Cable Ties – Plenum-Rated	B1.88
<i>TAK-TAPE</i> ™ Hook & Loop Cable Tie Rolls	B1.88
<i>ULTRA-CINCH</i> ™ Hook & Loop Cable Ties	B1.89
Hook and Loop Cable Ties	B1.90
Hot Stamping Service – Custom Printed Cable Ties	B1.91
<i>PANDUIT</i> Cable Tie Approvals	B1.92
Military Cross Reference	B1.93 – B1.95
Cable Tie Selection and Specification Guidelines	B1.96
Weathering	B1.97 – B1.98
Flammability	B1.99 – B1.100
Radiation/Moisture/Temperature/Tensile Strength	B1.101
Chemical Resistance Table	B1.102 – B1.105
Manual Cable Tie Installation Tools	B1.107
Selection Guide – Hand Tools, Accessories, and Kits	B1.108
Cable Tie Tools – Tool Controlled Tension and Cut-Off	B1.109
Cable Tie Tools – Installer Controlled Tension and Cut-Off	B1.110
Pneumatic Hand Tools – Tool Controlled Tension and Cut-Off	B1.111
Pneumatic Tool Accessories	B1.111
Tool Tension Locking Kits	B1.112
Blade Replacement Kits	B1.112
Hand Tool Holster	B1.112
★ Cushion Sleeve Kits	B1.112
Automatic Cable Tie Installation Systems	B1.113
Selection Guide – Automatic Installation Systems and Reel-Fed Cable Ties	B1.114
System Selection Guide	B1.115
Tool Head	B1.115
Dispenser	B1.115

★ Represents new product offering.

A. System Overview
B1. Cable Ties
B2. Cable Accessories
B3. Stainless Steel Ties
C1. Wiring Duct
C2. Surface Raceway
C3. Abrasion Protection
C4. Cable Management
D1. Terminals
D2. Power Connectors
D3. Grounding Connectors
E1. Labeling Systems
E2. Labels
E3. Pre-Printed & Write-On Markers
E4. Permanent Identification
E5. Lockout/ Tagout & Safety Solutions
F. Index

A.
System
Overview

Table of Contents

B1. Cable Ties	Transfer Hose	B1.116
	Dispenser Frame	B1.116
	Filter/Regulator and Air Supply Hose	B1.117
	Bench Mount	B1.117
B2. Cable Accessories	Data Interface Software and Ethernet Enabled Dispenser	B1.117
	BT-XMR Reel-Fed Cable Ties	B1.118
	PLT-XMR Reel-Fed Cable Ties	B1.119
	PLT-VMR Reel-Fed Cable Ties	B1.120
B3. Stainless Steel Ties	Tie Harness Mount for Single Cable Tie – Nylon and Heat Stabilized Nylon 6.6	B1.121
	Tie Harness Mounts – Nylon and Heat Stabilized Nylon 6.6	B1.121

Cable Accessories

C1. Wiring Duct	Cable Accessories	B2.1
	4-Way Adhesive Backed Cable Tie Mounts	B2.2 – B2.3
	ABMQ Multiple Bridge Mounts	B2.4
	<i>SUPER-GRIP</i> ® Adhesive Back Mounts	B2.5
	Combination Adhesive Mount/Cable Ties	B2.6
C2. Surface Raceway	Snap-In Cable Tie Mounts – Mechanically Applied	B2.6
	Epoxy Applied Mounts	B2.7
	Epoxy Applied Swivel Mount	B2.7
	Epoxy Applied Cable Tie Mount Kits	B2.8
C3. Abrasion Protection	Cable Tie Mounts	B2.9
	<i>TAK-TY</i> ® Hook & Loop Cable Tie Mounts	B2.10
	Extra-Heavy Cable Tie Mounts	B2.10
	Tie Mounts – Applied with User Supplied Adhesives	B2.11
	Low Profile Tie Mounts – User Supplied Adhesive Mounts	B2.11
C4. Cable Management	Swivel Mounts	B2.11
	Stud Tie Mounts	B2.12
	Tie Anchor Mounts – Screw Applied	B2.12
	Tie Anchor Mounts	B2.13
	Low Profile Mounts – Screw Applied	B2.13
D1. Terminals	★ <i>HYPER-V</i> ™ Cable Tie Mounts	B2.13
	<i>SUPER-GRIP</i> ® Tie Mounts	B2.14
	Low Profile Mounts – Push Rivet Applied	B2.14
D2. Power Connectors	Cable Tie Plates	B2.15
	Multiple Tie Plates	B2.15 – B2.16
	Contour Multiple Tie Plates	B2.16
	Right Angle Mounts	B2.17
	Lightening Hole Mounts	B2.17
D3. Grounding Connectors	Metal Clip-On Mounts	B2.18
	Metal Screw-On Mount	B2.18
	Push Barb Cable Tie Mounts	B2.18
	Push Mounts	B2.19
	Push Button Mount	B2.19
E1. Labeling Systems	Masonry Push Mounts	B2.20
	★ <i>SUPER-GRIP</i> ® Masonry Push Mounts	B2.20
	★ <i>HYPER-V</i> ™ Masonry Cable Tie Mounts	B2.21
	Wood Push Mount	B2.21
E2. Labels	★ Push Mounts with Umbrella	B2.22
	★ Push Mount Assemblies	B2.22
	Control Panel Mounts	B2.23
	<i>PAN-POST</i> ™ Standoff	B2.23
E3. Pre-Printed & Write-On Markers	Flat <i>PAN-POST</i> ™ Standoffs	B2.24
	Right Angle Bases	B2.24
	Flat Cable Mounting System – FCB Base and FCPI Plate	B2.25
	Closed Connector Rings	B2.26
	Open Connector Ring	B2.26
E4. Permanent Identification	Cable Spacers	B2.26
	Cable Spacer Cross	B2.27
	Stackable Aerial Cable Spacer	B2.27
	Aerial Support Ties – Weather Resistant Polypropylene	B2.28
E5. Lockout/ Tagout & Safety Solutions	Permanent Marking Pens	B2.28
	Marker Plates – Loose Piece	B2.29
	Cable and Wire Mounting Devices (used without cable ties)	B2.30
	Adhesive Backed Mounting Devices	B2.30
	<i>CLINCHER</i> ™ Adjustable Releasable Clamp	B2.30
F. Index	Adhesive Backed Cord Clips	B2.31

★ Represents new product offering.

Table of Contents

Push Mount Cord Clip	B2.31
“J” Clips	B2.32
A1C Type Clips	B2.32
A2C Type Clips	B2.33
Metal Adhesive Backed Cord Clips	B2.33
Latching Wire Clips	B2.34
Bevel Entry Clips	B2.35
Adhesive Backed Dual Cord Clip	B2.36
Adhesive Backed Mount Cord Clip	B2.36
Vertical Cord Clips	B2.36
Adhesive Backed Latching Clips	B2.37
Cable Holder – Adhesive Backed	B2.37
Low Profile Flat Cable Mounts	B2.37
Latching Flat Cable Mounts	B2.38
Latching Flat Cable Holders	B2.38
Flat Cable Clips	B2.39
<i>PAN-CLAMP™</i> Heavy Duty Fixed Diameter Clamps	B2.39
Fixed Diameter Cable Clamps	B2.40
Wire Retainers	B2.41
Tack Clips	B2.41
Siding Clips	B2.42
Wire Standoffs	B2.42
Snap-In Clips	B2.43
Wire Saddles	B2.43
Optical Fiber Network Saddle	B2.44
Harness Clips	B2.44
★ Nylon Edge Clips	B2.45
Wire Bundle Strap	B2.45
Circuit Board Posts	B2.46
Circuit Board Locking Supports	B2.46
Harness Board Accessories	B2.47
Elastic Retainers	B2.47
Elastic Retainers – ER Type	B2.47
Bundle Retainers	B2.48
Corner Posts	B2.48
T-Junction Fixture	B2.48
Wire End Holder	B2.49
Harness Board Nails	B2.49
Fanning Strip System	B2.50
Spring Wire Breakout System	B2.50
Harness Board Standoff Posts and Adaptor	B2.51
Physical Properties and Colors of Cable Accessory Materials	B2.52
Selection and Use of Adhesive Mounts	B2.52 – B2.54

Stainless Steel Cable Ties and Accessories

<i>PAN-STEEL®</i> System	B3.1
<i>PAN-STEEL®</i> Products Overview	B3.2 – B3.3
Features and Benefits – <i>PAN-STEEL®</i> Cable Ties	B3.4
Part Number System for <i>PAN-STEEL®</i> Cable Ties	B3.5
<i>PAN-STEEL®</i> Self-Locking Cable Ties – MLT Series	B3.5 – B3.7
<i>PAN-STEEL®</i> Polyester Fully Coated Cable Ties – MLTFC Series	B3.8
<i>PAN-STEEL®</i> Nylon 11 Selectively Coated Ties – MLTC Series	B3.9
★ <i>PAN-ALUM™</i> Aluminum Cable Ties – MLT Series	B3.10
<i>PAN-STEEL®</i> Double Wrapped Cable Ties – MLTD Series	B3.11
<i>PAN-STEEL®</i> Custom Length Banding – MBS, MBH, MBEH and MBSH Series	B3.12 – B3.13
<i>PAN-STEEL®</i> Custom Length Banding Heads – MTH Series	B3.13
GS4MT Hand Operated Installation Tool	B3.14
Tool Tension Locking Kits	B3.14
ST2MT Installation Tool	B3.15
★ RT1HT and RT1HTN Installation Tools	B3.15
HTMT Installation Tool	B3.15
PPTMT Pneumatic Installation Tool	B3.16
Adjustment Features for PPTMT and GS4MT Tools	B3.16
Features and Benefits – <i>PAN-STEEL®</i> Retained Tension Ties – MRT/MRS Series	B3.17
Part Number System for <i>PAN-STEEL®</i> Retained Tension Ties – MRT Series	B3.18
★ <i>PAN-STEEL®</i> Retained Tension Ties – MRT Series	B3.18
Part Number System for <i>PAN-STEEL®</i> 360° Radial Seal Retained Tension Ties – MRS Series	B3.19

★ Represents new product offering.

Table of Contents

A.
System
Overview

B1.
Cable Ties

B2.
Cable
Accessories

B3.
Stainless
Steel Ties

C1.
Wiring
Duct

C2.
Surface
Raceway

C3.
Abrasion
Protection

C4.
Cable
Management

D1.
Terminals

D2.
Power
Connectors

D3.
Grounding
Connectors

E1.
Labeling
Systems

E2.
Labels

E3.
Pre-Printed
& Write-On
Markers

E4.
Permanent
Identification

E5.
Lockout/
Tagout
& Safety
Solutions

F.
Index

★ <i>PAN-STEEL</i> ® 360° Radial Seal Retained Tension Ties – MRS Series	B3.19
★ Retained Tension Installation Tools	B3.20
MRT/MRS Installation Steps	B3.20
Features and Benefits – <i>PAN-STEEL</i> ® Strapping System	B3.21
The <i>PANDUIT</i> Method Reduces Installation Time	B3.22
Part Number System for Discrete Length Strapping	B3.22
Part Number System for Coil Strapping	B3.22
Part Number System for Strapping Buckles	B3.22
<i>PAN-STEEL</i> ® Strapping – MS Series	B3.23
<i>PAN-STEEL</i> ® Nylon 11 Coated Strapping – MSC Series	B3.24
<i>PAN-STEEL</i> ® Custom Length Strapping	B3.25
<i>PAN-STEEL</i> ® Buckles for Custom Length Strapping	B3.25
BT1HT Hand Operated Installation Tool for Strapping	B3.26
PCS Cushion Sleeve	B3.26
Stainless Steel Tie Mounts	B3.27
Stainless Steel Push Mount	B3.27
Stainless Steel Push Button Mount	B3.28
Stainless Steel 2-Way Tie Mount	B3.28
Stainless Steel Bulkhead Mount	B3.29
Stainless Steel Technical Information	B3.30
<i>PANDUIT</i> Stainless Steel Cable Tie and Strapping Approvals	B3.30
Chemical Resistance at 70°F (21°C) Temperature	B3.31
Rigorous Tests and Physical Properties of Stainless Steel	B3.32
Military Cross Reference (AS23190)	B3.32

Wiring Duct

Wiring Duct	C1.1
Wiring Duct for Control Panel Applications	C1.2 – C1.3
Features and Benefits – <i>PANDUCT</i> ® <i>PANELMAX</i> ™ Corner Wiring Duct	C1.4
★ <i>PANELMAX</i> ™ Corner Wiring Duct	C1.5
Features and Benefits – <i>PANDUCT</i> ® Type H and HN Hinged Cover Wiring Duct	C1.6
★ <i>PANDUCT</i> ® Type HN Hinged Cover Narrow Slot Wiring Duct	C1.7
<i>PANDUCT</i> ® Type H Hinged Cover Wide Slot Wiring Duct	C1.7
<i>PANDUCT</i> ® Type HS Hinged Cover Solid Wall Raceway	C1.7
Features and Benefits – <i>PANDUCT</i> ® Type G Wide Slot Wiring Duct	C1.8
<i>PANDUCT</i> ® Type G Wide Slot Wiring Duct	C1.9
Features and Benefits – <i>PANDUCT</i> ® Type F Narrow Slot Wiring Duct	C1.10
<i>PANDUCT</i> ® Type F Narrow Slot Wiring Duct	C1.11
Features and Benefits – <i>PANDUCT</i> ® Flush Cover Type D Round Hole Wiring Duct	C1.12
<i>PANDUCT</i> ® Flush Cover Type D Round Hole Wiring Duct	C1.13
Features and Benefits – <i>PANDUCT</i> ® Type MC Metric Narrow Slot Wiring Duct	C1.14
<i>PANDUCT</i> ® Type MC Metric Narrow Slot Wiring Duct	C1.15
Features and Benefits – <i>PANDUCT</i> ® Type FS Solid Wall Raceway	C1.16
<i>PANDUCT</i> ® Type FS Solid Wall Raceway	C1.17
Wiring Duct for Special Environments	C1.18 – C1.19
Features and Benefits – <i>PANDUCT</i> ® Type NNC Halogen-Free Metric Wiring Duct	C1.20
<i>PANDUCT</i> ® Type NNC Halogen-Free Metric Wiring Duct	C1.21
<i>PANDUCT</i> ® Type NNC Divider Wall	C1.21
Features and Benefits – <i>PANDUCT</i> ® Type TMC Low Smoke/Low Toxicity Wiring Duct	C1.22
<i>PANDUCT</i> ® Type TMC Low Smoke/Low Toxicity Wiring Duct	C1.23
<i>PANDUCT</i> ® Type TMC Low Smoke/Low Toxicity Solid Divider Wall	C1.23
<i>PANDUCT</i> ® Type NE NORYL* Halogen-Free Wiring Duct	C1.24
Wiring Duct Tools and Accessories	C1.25
<i>PANDUCT</i> ® Type FL Flexible Wiring Duct	C1.26
<i>PANDUCT</i> ® Divider Wall	C1.26
<i>PANDUCT</i> ® Type NNC Divider Wall	C1.27
<i>PANDUCT</i> ® Type TMC Low Smoke/Low Toxicity Solid Divider Wall	C1.27
<i>PANDUCT</i> ® Type G and H Wiring Duct Wire Retainers	C1.28
<i>PANDUCT</i> ® Solid Wall Raceway Type FS and Type D Wiring Duct Wire Retainer	C1.28
<i>PANDUCT</i> ® Type F, HN, MC and TMC Duct Wire Retainers/Labeling Device	C1.29
<i>PANDUCT</i> ® Duct Corner Strip with 1 Inch Bend Radius Control	C1.29
<i>PANDUCT</i> ® Duct Corner Strips	C1.30
<i>PANDUCT</i> ® Duct Joining Strips	C1.30
<i>PANDUCT</i> ® Snap-Clip Mounting Brackets	C1.31
<i>PANDUCT</i> ® Snap-Clip Mounting Bracket – Type NE Wiring Duct	C1.31
Adhesive Tape for Wiring Duct	C1.32
Specifications for Factory Applied Tape	C1.32

★ Represents new product offering.

*NORYL is a registered trademark of General Electric Company.

Table of Contents

Adhesive Tape Guide	C1.33
PANDUCT® Installation Tools	C1.34
PANDUCT® PANELMAX™ Corner Wiring Duct Dimensions	C1.35
PANDUCT® Type G and D Wiring Duct Dimensions	C1.36
PANDUCT® Type F Wiring Duct and FS Raceway Dimensions	C1.37
PANDUCT® Type MC and TMC Wiring Duct Dimensions	C1.38
PANDUCT® Type NNC Wiring Duct Dimensions	C1.39
PANDUCT® Type NE Wiring Duct Dimensions	C1.40
PANDUCT® Type H and HS Wiring Duct Dimensions	C1.41
PANDUCT® Type HN Wiring Duct Dimensions	C1.41
PANDUCT® Type FL Wiring Duct Dimensions	C1.42
PANDUCT® PANELMAX™ Corner Wiring Duct – Wirefill Capacity	C1.42
PANDUCT® Type H, HN and HS Wiring Duct – Wirefill Capacity	C1.42
PANDUCT® Type D, G, F and FS Wiring Duct – Wirefill Capacity	C1.43
PANDUCT® Type MC, NNC and TMC Wiring Duct – Wirefill Capacity	C1.44
PANDUCT® Type NE Wiring Duct – Wirefill Capacity	C1.45
PANDUCT® Type FL Wiring Duct – Wirefill Capacity	C1.45
Wirefill Formula	C1.46
PANDUCT® Wiring Duct and Raceway – Material Specifications	C1.47
PANDUCT® Wiring Duct and Raceway – Color and Size Selection	C1.48
Installation Tips	C1.49
Part Number System for Wiring Duct	C1.49
PANDUCT® Wiring Duct Approvals and Compliances	C1.50 – C1.51
FIBER-DUCT™ Routing System	C1.53
2x2 and 4x4 FIBER-DUCT™ Routing Systems Roadmap	C1.54 – C1.55
2x2 and 4x4 FIBER-DUCT™ Routing Systems	C1.56
FIBER-DUCT™ System Fittings	C1.56 – C1.57
FIBER-DUCT™ Spillouts	C1.58
FIBER-DUCT™ Bend Radius Control Trumpets	C1.59
FIBER-DUCT™ Accessories	C1.59
FIBER-DUCT™ Mounting Brackets	C1.60 – C1.61
Cable Fills 2x2 and 4x4 FIBER-DUCT™ Cable Routing Systems	C1.62

Surface Raceway

PAN-WAY® Metal Raceway	C2.1
PMR40 Raceway Roadmap	C2.2 – C2.3
PMR40 Configurations	C2.4
★ PAN-WAY® PMR40 Metal Raceway System	C2.5
★ PAN-WAY® PMR40 Metal Raceway Fittings	C2.5 – C2.6
Cable Fill Capacities for PMR40 Metal Raceway	C2.7
PMR5/7 Raceway Roadmap	C2.8 – C2.9
PMR5/PMR7 Configurations	C2.10
★ PAN-WAY® PMR5/PMR7 Metal Raceway System	C2.11
★ PAN-WAY® PMR5/PMR7 Metal Raceway Fittings	C2.12
★ PMR5 and PMR7 Raceway Accessories	C2.13
Cable Fill Capacities for PMR5/PMR7 Metal Raceway	C2.14
★ PAN-WAY® Metal Raceway Boxes	C2.15 – C2.16
★ PAN-WAY® Metal Raceway Faceplates	C2.17
PAN-WAY® Non-Metallic Surface Raceway	C2.18
PAN-WAY® TG-70 Non-Metallic Surface Raceway	C2.19
TG-70 Raceway Roadmap	C2.20 – C2.21
TG-70 Configurations	C2.22 – C2.23
PAN-WAY® TG-70 Surface Raceway System	C2.24
PAN-WAY® TG-70 Raceway Fittings	C2.25
PAN-WAY® TG-70 Raceway Accessories	C2.26
Cable Fill Capacities for TG-70 Raceway	C2.27
PAN-WAY® T-70 and Twin-70 Non-Metallic Surface Raceway	C2.29
T-70 Raceway Roadmap	C2.30 – C2.31
T-70 Configurations	C2.32 – C2.33
Twin-70 Raceway Roadmap	C2.34 – C2.35
PAN-WAY® T-70 Surface Raceway System	C2.36
PAN-WAY® T-70 Raceway Fittings	C2.36 – C2.37
PAN-WAY® Twin-70 Surface Raceway System	C2.38
PAN-WAY® Twin-70 Raceway Fittings	C2.39
PAN-WAY® T-70 and Twin-70 Raceway Accessories	C2.40
Cable Fill Capacities for T-70 Raceway	C2.41
Cable Fill Capacities for Twin-70 Raceway	C2.42

★ Represents new product offering.

A. System Overview
B1. Cable Ties
B2. Cable Accessories
B3. Stainless Steel Ties
C1. Wiring Duct
C2. Surface Raceway
C3. Abrasion Protection
C4. Cable Management
D1. Terminals
D2. Power Connectors
D3. Grounding Connectors
E1. Labeling Systems
E2. Labels
E3. Pre-Printed & Write-On Markers
E4. Permanent Identification
E5. Lockout/ Tagout & Safety Solutions
F. Index

Table of Contents

A. System Overview		
B1. Cable Ties	PAN-WAY® T-45 Non-Metallic Surface Raceway	C2.43
	T-45 Raceway Roadmap	C2.44 – C2.45
	T-45 Configurations	C2.46 – C2.47
	PAN-WAY® T-45 Surface Raceway System	C2.48
B2. Cable Accessories	PAN-WAY® Type T-45 Raceway Fittings	C2.49
	Cable Fill Capacities for T-45 Raceway	C2.50
	PAN-WAY® Snap-On Faceplates and Surface Mount Outlet Boxes	C2.51
	PAN-WAY® FAST-SNAP™ Surface Mount Outlet Boxes	C2.52
	PAN-WAY® Classic Series Snap-On Faceplates for Use with PANDUIT® MINI-COM® Modules	C2.52
B3. Stainless Steel Ties	Component Labels for PAN-WAY® Classic Series Snap-On Faceplates for Use with PANDUIT® MINI-COM® Modules and Inserts	C2.52
	PAN-WAY® Classic Series Snap-On Faceplates for Use with PANDUIT® MINI-COM® Inserts	C2.53
	PAN-WAY® Classic Series Snap-On Faceplates for Communication/Power	C2.53
C1. Wiring Duct	PANDUIT® NETKEY® Snap-On Sloped Keystone Faceplates	C2.54
	PANDUIT® NETKEY® Snap-On Flush Universal Keystone Faceplates	C2.54
	PAN-WAY® Snap-On Faceplates for SYSTIMAX® Communication Modules	C2.55
	PAN-WAY® Snap-On Faceplates for Nordx/CDT® Communication Modules	C2.56
C2. Surface Raceway	PAN-WAY® Low Voltage Surface Mount Outlet Boxes	C2.57
	PAN-WAY® Power Rated Surface Mount Outlet Boxes	C2.58
	PAN-WAY® Classic Series Faceplates for Power and Communication Applications	C2.59
	PAN-WAY® Stainless Steel Faceplates	C2.60
	PAN-WAY® Electrical Outlets	C2.60
C3. Abrasion Protection	PAN-WAY® Surface Mount Outlet Box with 20 A Electrical Outlet	C2.60
	Selection Chart for using PAN-WAY® Surface Raceway with PAN-WAY® Surface Mount Outlet Boxes	C2.61
	PAN-WAY® LD Profile Non-Metallic Surface Raceway	C2.63
	LD2P10 Profile Raceway Roadmap	C2.64 – C2.65
	LD2P10 Configurations	C2.66 – C2.67
C4. Cable Management	LD Profile Raceway Roadmap	C2.68 – C2.69
	LD Configurations	C2.70 – C2.71
	LDPH Profile Raceway Roadmap	C2.72 – C2.73
	LDPH Configurations	C2.74
D1. Terminals	PAN-WAY® Type LD2P10 Multi-Channel Surface Raceway System	C2.75
	Multi-Channel Fittings for LD2P10	C2.75
	PAN-WAY® LD Surface Raceway System	C2.76
	PAN-WAY® LDPH Surface Raceway System	C2.77
D2. Power Connectors	PAN-WAY® LDS Surface Raceway System	C2.78
	Method for Bending Type LDS Raceway (Low Voltage Applications)	C2.78
	Standard Fittings for Low Voltage Applications	C2.79
	One Inch Bend Radius Fittings for TIA/EIA Compliance	C2.80
	Power Rated Fittings for Power to 600 V – LDPH/LDS/LD2P Raceway Only	C2.81
D3. Grounding Connectors	Raceway Adapters for LD Raceway	C2.82
	Cable Fill Capacities for LD Profile Raceway	C2.82
	Floor Guard	C2.83
	PAN-WAY® Surface Raceway Cutting Tool	C2.83
	Foam Tape	C2.84
E1. Labeling Systems	PAN-WAY® Cove Raceway	C2.85
	Cove Raceway Roadmap	C2.86 – C2.87
	Cove Configurations	C2.88 – C2.89
	PAN-WAY® Cove Raceway System	C2.90
	PAN-WAY® Cove Raceway Fittings	C2.91
E2. Labels	Cable Fill Capacities for Cove Raceway	C2.92
	PAN-WAY® Office Furniture Raceway	C2.93
	Office Furniture Raceway Roadmap	C2.94 – C2.95
	Office Furniture Configurations	C2.96 – C2.97
E3. Pre-Printed & Write-On Markers	PAN-WAY® Office Furniture Raceway System	C2.98
	PAN-WAY® Office Furniture Raceway Fittings	C2.98 – C2.101
	Cable Fill Capacities for Office Furniture Raceway	C2.102
	PAN-POLE™ Power and Communication Poles	C2.103
E4. Permanent Identification	PAN-POLE™ Power Pole	C2.104
	Installation of Communication Outlets on PAN-POLE™ Power Pole	C2.105 – C2.106
	PAN-POLE™ Communication Pole	C2.107
	Installation of Communication Outlets on PAN-POLE™ Communication Pole	C2.108 – C2.109
E5. Lockout/ Tagout & Safety Solutions	PAN-POLE™ Extension Kits	C2.110
	PAN-POLE™ Power Addition Kits and Standard Faceplate Bracket	C2.110
	PAN-POLE™ Replacement Parts	C2.111
	Cable Fill Capacities for PAN-POLE™ Power and Communication Poles	C2.112
F. Index		

*SYSTIMAX is a registered trademark of Commscope, Inc.

**Nordx/CDT is a registered trademark of Nordx/CDT, Inc.

Table of Contents

Abrasion Protection

Abrasion Protection	C3.1
<i>PAN-WRAP</i> ™ Split Harness Wrap	C3.2
<i>PAN-WRAP</i> ™ Installation Tools	C3.2
Part Number System for Spiral Wrap	C3.3
Spiral Wrap	C3.4 – C3.7
Part Number System for Grommet Edging	C3.8
Grommet Edging	C3.8 – C3.10
Part Number System for Corrugated Loom Tubing	C3.11
Corrugated Loom Tubing – Slit	C3.11 – C3.12
Corrugated Loom Tubing Fittings	C3.12
Part Number System for Braided Expandable Sleeving	C3.13
Braided Expandable Sleeving – Polyethylene Terephthalate (PET)	C3.13
Braided Expandable Sleeving – Flame Retardant Polyethylene Terephthalate	C3.14
Tooling Head	C3.14
Fray Resistant Braided Expandable Sleeving	C3.15
Part Number System for Non-Shrink PVC Tubing	C3.16
Non-Shrink PVC Tubing	C3.16
Duct Seal – Sealing Compounds	C3.16
Flammability Tests and Classification	C3.17
Abrasion Protection Materials Technical Data	C3.18 – C3.19
<i>PANDUIT</i> Heat Shrink Tubing Selection Guide	C3.20
Part Number System for Thin Wall Heat Shrink	C3.21
HSTT Heat Shrink 4 Foot Pieces	C3.22 – C3.23
HSTT Heat Shrink on 25 Foot Reels	C3.23
Heat Shrink in 6 Inch Pieces; Single Color, Single Diameter	C3.24
Heat Shrink in 6 Inch Pieces; Multi-Color, Single Diameter	C3.24
Heat Shrink in 6 Inch Pieces; Black, Multiple Diameters	C3.25
Heat Shrink in 6 Inch Pieces; Yellow/Green Stripe, Multiple Diameters	C3.25
HSTTV Heat Shrink 4 Foot Pieces	C3.26
HSTTV Heat Shrink on 100 Foot Reels	C3.27
HSTTV Heat Shrink on Bulk Reels	C3.28
HSTTV Heat Shrink on 25 Foot Reels	C3.29
HSTTV Heat Shrink 6 Inch Pieces	C3.29
HSTTP PVC Heat Shrink	C3.30
HSTTPN Crystal Clear PVC Heat Shrink	C3.31
HSTTN Neoprene Heat Shrink	C3.31
TEFLON [®] Heat Shrink	C3.32
HSTTK KYNAR [®] Heat Shrink 4 Foot Pieces	C3.33
HSTTVA Heat Shrink 4 Foot Pieces	C3.33 – C3.34
HSTTA Heat Shrink 4 Foot and 6 Inch Pieces	C3.34
HSTTRA Heat Shrink 4 Foot pieces	C3.35
Thick Wall Polyolefin Heat Shrink	C3.35 – C3.36
Heat Shrink End Caps	C3.37
Plastic Heat Shrink Tubing Kit Boxes – For Dry Locations	C3.38
Heat Shrink Tools and Accessories	C3.38
Heat Shrink Installation Instructions	C3.39
Recommended Tubing Size for Common Wire Types Based on Location	C3.40
IP (Ingress Protection) as defined by the International Standard IEC 529	C3.41
<i>DRY-SHRINK</i> ™, <i>DAMP-SHRINK</i> ™, and <i>WET-SHRINK</i> ™ Heat Shrink Tubing	C3.42

Cable Management

Cable Management	C4.1
★ <i>COOL BOOT</i> ™ Raised Floor Assembly	C4.2 – C4.3
<i>J-PRO</i> ™ Cable Support System	C4.4 – C4.6
<i>J-MOD</i> ® Cable Support System	C4.7
Conduit Waterfall	C4.8
Waterfall Accessories	C4.8
★ Double Waterfall Accessory	C4.9
Stackable Cable Rack Spacers	C4.9
Threaded Rod Cover	C4.10
Vertical D-Rings	C4.10
<i>TAK-TY</i> ® Hook & Loop Cable Tie Mounts	C4.11
Flat <i>PAN-POST</i> ™ Standoffs	C4.11
Communication Cable Management Kit for Cabinets	C4.12

★TEFLON is a registered trademark of E.I. du Pont de Nemours and Company.

★KYNAR is a registered trademark of Atofina Chemicals, Inc.

★ Represents new product offering.

Table of Contents

Terminals

A. System Overview		
B1. Cable Ties		
B2. Cable Accessories		
B3. Stainless Steel Ties		
C1. Wiring Duct		
C2. Surface Raceway		
C3. Abrasion Protection		
C4. Cable Management		
D1. Terminals		
D2. Power Connectors		
D3. Grounding Connectors		
E1. Labeling Systems		
E2. Labels		
E3. Pre-Printed & Write-On Markers		
E4. Permanent Identification		
E5. Lockout/ Tagout & Safety Solutions		
F. Index		

PAN-TERM® Terminals	D1.1
Features and Benefits – PAN-TERM® Terminals	D1.2
Selection Guide – PAN-TERM® Ring Terminals	D1.3
Selection Guide – PAN-TERM® Fork Terminals	D1.4
Part Number System for PAN-TERM® Terminals	D1.5
Ring Terminal, Nylon Insulated	D1.6
Ring Terminal, Nylon Insulated – Expanded Insulation	D1.7
Ring Terminal, Nylon Insulated – Funnel Entry	D1.8
Multiple Stud Terminal, Nylon Insulated	D1.9
Ring Terminal, Vinyl Insulated – Funnel Entry	D1.10
Ring Terminal, Vinyl Expanded Insulation	D1.11
Multiple Stud Terminal, Vinyl Insulated – Funnel Entry	D1.12
Ring Terminal, KYNAR® Insulated	D1.12
Heat Shrink, Ring Terminal	D1.13
Ring Terminal, Heavy Duty, Nylon Insulated	D1.13
Ring Terminal, Heavy Duty, Vinyl Insulated – Funnel Entry	D1.14
Ring Terminal, Large Wire, Vinyl Insulated	D1.15
Ring Terminal, Large Wire, Vinyl Expanded Insulation	D1.16
Ring Terminal, Non-Insulated	D1.17
Multiple Stud Terminal, Non-Insulated	D1.18
Ring Terminal, Non-Insulated – High Temperature	D1.18
Ring Terminal, Heavy Duty Non-Insulated	D1.19
Ring Terminal, Large Wire Non-Insulated	D1.19
Tubular Ring Terminal, Non-Insulated	D1.20
Fork Terminal, Nylon Insulated	D1.21
Fork Terminal, Nylon Insulated – Funnel Entry	D1.22
Fork Terminal, Vinyl Insulated – Funnel Entry	D1.23
Fork Terminal, Vinyl Insulated – Expanded Insulation	D1.24
Locking Fork Terminal, Nylon Insulated	D1.24
Locking Fork Terminal, Nylon Insulated – Funnel Entry	D1.25
Locking Fork Terminal, Vinyl Insulated – Funnel Entry	D1.25
Locking Fork Terminal, Vinyl Insulated – Expanded Insulation	D1.26
Short Locking Fork Terminal, Nylon Insulated	D1.26
Short Locking Fork Terminal, Nylon Insulated – Funnel Entry	D1.27
Short Locking Fork Terminal, Vinyl Insulated – Funnel Entry	D1.27
Flanged Fork Terminal, Nylon Insulated	D1.28
Flanged Fork Terminal, Vinyl Insulated – Funnel Entry	D1.28
Fork Terminal, Non-Insulated	D1.29
Flanged Fork Terminal, Non-Insulated	D1.30
Locking Fork Terminal, Non-Insulated	D1.30
Short Locking Fork Terminal, Non-Insulated	D1.31
Heat Shrink, Fork Terminal	D1.31
Features and Benefits – PAN-TERM® Metric Terminals	D1.32
Part Number System for PAN-TERM® Metric Terminals	D1.33
Metric Ring Terminal, Nylon Insulated – Funnel Entry	D1.33
Metric Ring Terminal, Vinyl Insulated – Funnel Entry	D1.34
Metric Ring Terminal, Non-Insulated	D1.34
Metric Fork Terminal, Nylon Insulated – Funnel Entry	D1.35
Metric Fork Terminal, Vinyl Insulated – Funnel Entry	D1.35
Metric Fork Terminal, Non-Insulated	D1.36
Plastic Box Terminal Kits	D1.36
Steel Kit Boxes	D1.37
Steel Slide Racks	D1.37
Industrial Maintenance Kits	D1.38
PAN-TERM® Disconnects	D1.39
Features and Benefits – PAN-TERM® Disconnects	D1.40 – D1.41
Selection Guide – PAN-TERM® Disconnects	D1.42
Part Number System for PAN-TERM® Disconnects	D1.43
SUPRA-GRIP™ Female Disconnect, Nylon Fully Insulated – Funnel Entry	D1.43
DISCO-LOK™ Female Disconnect, Nylon Fully Insulated – Funnel Entry	D1.44
Male/Female Coupler, Nylon Fully Insulated – Funnel Entry	D1.44
Female Disconnect Nylon Fully Insulated – Funnel Entry	D1.45
Female Disconnect, Nylon Fully Insulated – Funnel Entry, Metal Collar	D1.45
DISCOGRIP™ Male Disconnect, Premium Nylon Fully Insulated – Funnel Entry	D1.46
DISCOGRIP™ Female Disconnect, Premium Nylon Fully Insulated – Funnel Entry	D1.46
Heat Shrink Disconnects, Fully Insulated – Funnel Entry	D1.47
Female Disconnect, Nylon Barrel Insulated – Funnel Entry	D1.47

*KYNAR is a registered trademark of Atofina Chemicals, Inc.

Table of Contents

Female Disconnect, Vinyl Barrel Insulated – Funnel Entry	D1.48
Female Disconnect, Vinyl Barrel Insulated – Butted Seam	D1.48
Female Disconnect, Non-Insulated – Metal Sleeve	D1.49
Right Angle Female Disconnect, Nylon Fully Insulated – Funnel Entry	D1.49
Right Angle Female Disconnect, Nylon Insulated – Funnel Entry	D1.50
Right Angle Female Disconnect, Non-Insulated – Metal Sleeve	D1.50
Right Angle Female Disconnect Non-Insulated	D1.51
Piggyback Disconnect, Vinyl Insulated	D1.51
Disconnect Adapter, Non-Insulated	D1.51
Male Disconnect, Nylon Barrel Insulated – Funnel Entry	D1.52
Male Disconnect, Vinyl Barrel Insulated – Funnel Entry	D1.52
Male Disconnect, Non-Insulated – Butted Seam	D1.53
Selection Guide – Specialty Terminals	D1.54
Pin Terminal, Vinyl Insulated – Funnel Entry	D1.54
Pin Terminal, Non-Insulated	D1.54
Male Blade Adapter, Vinyl Insulated – Funnel Entry	D1.55
Male Blade Adapter, Non-Insulated	D1.55
Features and Benefits – <i>PAN-TERM</i> ® Metric Disconnects	D1.56
Part Number System for <i>PAN-TERM</i> ® Metric Disconnects	D1.57
Female Metric Disconnect, Fully Insulated Nylon – Funnel Entry	D1.57
Female Metric Disconnect, Nylon Barrel Insulated – Funnel Entry	D1.58
Female Metric Disconnect, Vinyl Barrel Insulated – Funnel Entry	D1.58
Female Metric Disconnect, Non-Insulated – Metal Sleeve	D1.58
Piggyback Metric Disconnect, Vinyl Barrel Insulated	D1.59
Male Metric Disconnect, Fully Insulated Nylon – Funnel Entry	D1.59
Male Metric Disconnect, Nylon Barrel Insulated – Funnel Entry	D1.59
Male Metric Disconnect, Non-Insulated – Butted Seam	D1.60
Metric Pin Terminal, Vinyl Insulated – Funnel Entry	D1.60
Metric Pin Terminal, Non-Insulated	D1.60
<i>PAN-TERM</i>® Splices	D1.61
Features and Benefits – <i>PAN-TERM</i> ® Splices and Wire Joints	D1.62 – D1.63
Selection Guide – <i>PAN-TERM</i> ® Splices and Wire Joints	D1.64
Part Number System for <i>PAN-TERM</i> ® Splices	D1.64
Part Number System for <i>PAN-TERM</i> ® Wire Joints	D1.64
Butt Splice, Nylon Insulated	D1.65
Butt Splice, Vinyl Insulated	D1.65
Butt Splice, Non-Insulated	D1.66
Parallel Splice, Nylon Insulated	D1.66
Parallel Splice, Non-Insulated	D1.67
Wire Joint, Nylon Insulated	D1.67
Wire Joint, Non-Insulated	D1.68
Heat Shrink, Butt Splices	D1.68
Metric Butt Splice, Vinyl Insulated	D1.68
Metric Butt Splice, Non-Insulated	D1.69
Metric Wire Joints, Nylon Insulated	D1.69
<i>PAN-TERM</i>® Ferrules	D1.70
Features and Benefits – <i>PAN-TERM</i> ® Ferrules	D1.71
Selection Guide – <i>PAN-TERM</i> ® Ferrules	D1.72
Part Number System for <i>PAN-TERM</i> ® Ferrules	D1.72
Insulated Ferrules – Single Wire DIN End Sleeve	D1.73
Insulated Ferrules – Single Wire French End Sleeve	D1.74
Insulated Ferrules – Twin Wire DIN End Sleeve	D1.75
★ Insulated Ferrules on Strips – Single Wire	D1.75
Ferrules, Non-Insulated	D1.76 – D1.77
Ferrule Assortment Kits	D1.78
Terminal Crimping Tools	D1.79
Crimping Guidelines for <i>PANDUIT</i> ® <i>PAN-TERM</i> ® Terminals, Disconnects, Splices and Wire Joints	D1.80 – D1.82
Hand Operated Plier Type Tools	D1.83
Wire and Cable Stripping Tools	D1.83
<i>CONTOUR CRIMP</i> ™ Controlled Cycle Tools	D1.84
Controlled Cycle Crimping Tools	D1.85
Controlled Cycle Crimping Tools – Ferrule End Sleeve	D1.85
★ Semiautomatic Ferrule Crimping Tool CT-1000	D1.86
Controlled Cycle Crimping Tools – In-Line	D1.86
Pneumatic Crimping Tool	D1.86
Die Type, Manual, Crimping Tool	D1.87
CD-720 Crimping Dies	D1.87
★ CT-2500 Battery Powered Crimping Tool	D1.88
Tooling Selection Guide for <i>PANDUIT</i> Terminals, Splices, and Disconnects	D1.89 – D1.91
Tooling Selection Guide for <i>PANDUIT</i> Tubular Ring Terminals	D1.92

★ Represents new product offering.

A.
System
Overview

B1.
Cable Ties

B2.
Cable
Accessories

B3.
Stainless
Steel Ties

C1.
Wiring
Duct

C2.
Surface
Raceway

C3.
Abrasion
Protection

C4.
Cable
Management

D1.
Terminals

D2.
Power
Connectors

D3.
Grounding
Connectors

E1.
Labeling
Systems

E2.
Labels

E3.
Pre-Printed
& Write-On
Markers

E4.
Permanent
Identification

E5.
Lockout/
Tagout
& Safety
Solutions

F.
Index

Table of Contents

A. System Overview		
B1. Cable Ties	Tooling Selection Guide for <i>PANDUIT</i> Ferrules	D1.93
	Technical Specification and Selection Information	D1.94
	<i>PANDUIT</i> Terminal Approvals	D1.94
	Performance Requirements	D1.95
B2. Cable Accessories	<i>PANDUIT</i> ® <i>PAN-TERM</i> ® Terminal Military Cross Reference	D1.95
	Stud Size Chart (Inches/mm)	D1.96
	Equivalent Tables	D1.97
	Common Conductor Size Chart (Stranded Wire)	D1.97
	Common Conductor Sizes and Strandings Reference Chart	D1.98 – D1.99
B3. Stainless Steel Ties	REEL SMART™ System	D1.101
	Features and Benefits – <i>REEL SMART</i> ™ Termination System	D1.102
	<i>REEL SMART</i> ™ CA9 <i>EZAIR</i> ™ Universal Applicator	D1.102
	Nylon Insulated Terminals with Insulation Grip Sleeve (Funnel and Non-Funnel Entry Types)	D1.102
C1. Wiring Duct	Part Number System for <i>REEL SMART</i> ™ Terminals	D1.103
	Ring Terminals, Nylon Insulated – Non-Funnel Entry	D1.103
	Ring Terminals, Nylon Insulated – Funnel Entry	D1.104
	Ring Terminals, Vinyl Insulated – Funnel Entry	D1.105
	Multiple Stud Ring Terminals, Vinyl Insulated – Funnel Entry	D1.105
C2. Surface Raceway	Ring Terminals, Nylon Insulated – Heavy Duty	D1.106
	Ring Terminals, Vinyl Insulated – Heavy Duty	D1.106
	Fork Terminals, Nylon Insulated – Non-Funnel Entry	D1.107
	Fork Terminals, Nylon Insulated – Funnel Entry	D1.108
	Fork Terminals, Vinyl Insulated – Funnel Entry	D1.109
C3. Abrasion Protection	Locking Fork Terminals, Nylon Insulated – Non-Funnel Entry	D1.110
	Locking Fork Terminals, Nylon Insulated – Funnel Entry	D1.110
	Locking Fork Terminals, Vinyl Insulated – Funnel Entry	D1.111
	Short Locking Fork Terminals, Nylon Insulated – Non-Funnel Entry	D1.112
C4. Cable Management	Short Locking Fork Terminals, Nylon Insulated – Funnel Entry	D1.112
	Short Locking Fork Terminals, Vinyl Insulated – Funnel Entry	D1.113
	Flanged Fork Terminals, Nylon Insulated – Non-Funnel Entry	D1.113
	Flanged Fork Terminals, Nylon Insulated – Funnel Entry	D1.114
	Flanged Fork Terminals, Vinyl Insulated – Funnel Entry	D1.114
D1. Terminals	Features and Benefits – <i>REEL SMART</i> ™ Metric Terminals	D1.115
	Part Number System for <i>REEL SMART</i> ™ Metric Terminals	D1.115
	★ Metric Ring Terminals, Nylon Insulated – Non-Funnel Entry	D1.116
	★ Metric Ring Terminals, Nylon Insulated – Funnel Entry	D1.117
	★ Metric Ring Terminals, Vinyl Insulated – Funnel Entry	D1.118
D2. Power Connectors	★ Metric Fork Terminals, Nylon Insulated – Non-Funnel Entry	D1.119
	★ Metric Fork Terminals, Nylon Insulated – Funnel Entry	D1.119
	★ Metric Fork Terminals, Vinyl Insulated – Funnel Entry	D1.120
	Features and Benefits – <i>REEL SMART</i> ™ Disconnects	D1.121
D3. Grounding Connectors	Part Number System for <i>REEL SMART</i> ™ Disconnects	D1.122
	<i>SUPRA-GRIP</i> ™ Female Disconnects, Nylon Fully Insulated – Funnel Entry	D1.122
	<i>DISCO-LOK</i> ™ Female Disconnects, Nylon Fully Insulated – Funnel Entry	D1.123
	Female Disconnects, Nylon Fully Insulated – Funnel Entry	D1.123
	<i>DISCO</i> ™ Female Disconnects, Nylon Fully Insulated – Expanded Wire Entry	D1.124
	<i>DISCO</i> ™ Female Disconnects, Nylon Fully Insulated – Right Angle	D1.124
	<i>DISCO</i> ™ Female Disconnects, Vinyl Barrel Insulated – Funnel Entry	D1.125
	<i>DISCOGRIP</i> ™ Female Disconnects, Fully Insulated	D1.126
	<i>DISCOGRIP</i> ™ Male Disconnects, Fully Insulated	D1.127
	<i>DISCO</i> ™ Male Disconnects, Nylon Fully Insulated – Funnel Entry	D1.128
	<i>DISCO</i> ™ Male Disconnects, Nylon Fully Insulated – Expanded Wire Entry	D1.128
E1. Labeling Systems	<i>DISCO</i> ™ Male Disconnects, Nylon Barrel Insulated – Funnel Entry	D1.129
	<i>DISCO</i> ™ Male Disconnects, Vinyl Barrel Insulated – Funnel Entry	D1.129
	Pin Terminals, Vinyl Insulated – Funnel Entry	D1.130
	Male Blade Adapters, Vinyl Insulated – Funnel Entry	D1.130
	Butt Splices Nylon Insulated and Premium Grade Nylon	D1.130
	Features and Benefits – <i>REEL SMART</i> ™ Metric Disconnects	D1.131
	Part Number System for <i>REEL SMART</i> ™ Metric Disconnects	D1.132
	★ Metric <i>SUPRA-GRIP</i> ™ Female Disconnects, Nylon Fully Insulated – Funnel Entry	D1.132
	★ Metric <i>DISCO-LOK</i> ™ Female Disconnects, Nylon Fully Insulated – Funnel Entry	D1.133
E2. Labels	★ Metric Female Disconnects, Nylon Fully Insulated – Funnel Entry	D1.133
	★ Metric <i>DISCO</i> ™ Female Disconnects, Nylon Fully Insulated – Expanded Wire Entry	D1.134
	★ Metric <i>DISCO</i> ™ Female Disconnects, Nylon Fully Insulated – Right Angle	D1.134
	★ Metric <i>DISCO</i> ™ Female Disconnects, Vinyl Barrel Insulated – Funnel Entry	D1.135
	★ Metric <i>DISCOGRIP</i> ™ Female Disconnects, Fully Insulated – Funnel Entry	D1.135
	★ Metric <i>DISCOGRIP</i> ™ Male Disconnects, Fully Insulated – Funnel Entry	D1.136
	★ Metric <i>DISCO</i> ™ Male Disconnects, Nylon Fully Insulated – Funnel Entry	D1.136
	★ Metric <i>DISCO</i> ™ Male Disconnects, Nylon Fully Insulated – Expanded Wire Entry	D1.137
	★ Metric <i>DISCO</i> ™ Male Disconnects, Nylon Barrel Insulated – Funnel Entry	D1.137
E3. Pre-Printed & Write-On Markers		
E4. Permanent Identification		
E5. Lockout/ Tagout & Safety Solutions		
F. Index		

★ Represents new product offering.

Table of Contents

★ Metric <i>DISCO</i> ™ Male Disconnects, Vinyl Barrel Insulated – Funnel Entry	D1.138
★ Metric Pin Terminals, Vinyl Insulated – Funnel Entry	D1.138
★ Metric Male Blade Adapters, Vinyl Insulated – Funnel Entry	D1.139
★ Metric Butt Splices, Nylon Insulated	D1.139
Features and Benefits – <i>REEL SMART</i> ™ Ferrules	D1.140
Part Number System for <i>REEL SMART</i> ™ Ferrules	D1.140
★ Insulated Ferrules on Strips – Single Wire	D1.141
★ Semiautomatic Ferrule Crimping Tool – CT-1000	D1.142
★ Insulated Ferrules on Reels – Single Wire	D1.142
★ <i>REEL SMART</i> ™ Ferrule Applicator – CA10	D1.143
CA9 <i>EZAIR</i> ™ and CA-800EZ Applicators	D1.143
★ Electric Bench Press	D1.144
Die Sharpening Kits	D1.144
Die Information	D1.145 – D1.146
CA10, CA9 <i>EZAIR</i> ™, CA-800EZ and CA-800 Applicators Wire Processing Machine	
Manufacturer/Press Compatibility	D1.147
Performance Requirements	D1.148

Power Connectors

Compression Connector Reference Information	D2.0
<i>PAN-LUG</i>™ Compression Connectors	D2.1
Features and Benefits – <i>PAN-LUG</i> ™ Compression Connectors	D2.2
Selection Guide – <i>PAN-LUG</i> ™ Copper Compression Connectors for Copper Code Conductor	D2.3
Selection Guide – <i>PAN-LUG</i> ™ Copper Compression Connectors for Copper Code and/or Flex Conductor	D2.4
Selection Guide – <i>PAN-LUG</i> ™ Aluminum Compression Connectors for Aluminum or Copper Code Conductor	D2.5
Part Number System for Lugs	D2.6
Code Conductor, One-Hole, Short Barrel with Window Lug	D2.7 – D2.8
Code Conductor, One-Hole, Short Barrel with Window Lug, 45° Angle	D2.9 – D2.10
Code Conductor, One-Hole, Short Barrel with Window Lug, 90° Angle	D2.11 – D2.12
Code Conductor, One-Hole, Standard Barrel with Window Lug	D2.13 – D2.14
Code Conductor, One-Hole, Standard Barrel with Window Lug, 45° Angle	D2.15 – D2.16
Code Conductor, One-Hole, Standard Barrel with Window Lug, 90° Angle	D2.17 – D2.18
Code Conductor, One-Hole, Standard Barrel with Window, Narrow Tongue Lug	D2.19 – D2.20
Code Conductor, Short Blank Tongue, Standard Barrel with Window Lug	D2.21
Code Conductor, One-Hole, Long Barrel Lug	D2.22 – D2.23
Code Conductor, One-Hole, Long Barrel Lug, 45° Angle	D2.24 – D2.25
Code Conductor, One-Hole, Long Barrel Lug, 90° Angle	D2.26 – D2.27
Code Conductor, One-Hole, Long Barrel with Window Lug	D2.28
Code Conductor, One-Hole, Long Barrel with Window Lug, 45° Angle	D2.29
Code Conductor, One-Hole, Long Barrel with Window Lug, 90° Angle	D2.29
Code Conductor, One-Hole, Long Barrel with Corona Relief Taper Lug	D2.30
Code Conductor, Two-Hole, Standard Barrel with Window Lug	D2.31 – D2.32
Code Conductor, Two-Hole, Standard Barrel with Window Lug, 45° Angle	D2.33 – D2.34
Code Conductor, Two-Hole, Standard Barrel with Window Lug, 90° Angle	D2.35 – D2.36
Code Conductor, Two-Hole, Standard Barrel with Window, Narrow Tongue Lug	D2.37
Code Conductor, Two-Hole, Standard Barrel with Window, Narrow Tongue Lug, 45°	D2.38
Code Conductor, Two-Hole, Standard Barrel with Window, Narrow Tongue Lug, 90°	D2.39
Code Conductor, Long Blank Tongue, Standard Barrel with Window Lug	D2.40
Code Conductor, Two-Hole, Long Barrel Lug	D2.41 – D2.42
Code Conductor, Two-Hole, Long Barrel Lug, 45° Angle	D2.43 – D2.44
Code Conductor, Two-Hole, Long Barrel Lug, 90° Angle	D2.45 – D2.46
Code Conductor, Two-Hole, Long Barrel with Window Lug	D2.47 – D2.49
Code Conductor, Two-Hole, Long Barrel with Window Lug, 45° Angle	D2.50 – D2.52
Code Conductor, Two-Hole, Long Barrel with Window Lug, 90° Angle	D2.53 – D2.55
Code Conductor, Two-Hole, Long Barrel with Window, Narrow Tongue Lug	D2.55
Code Conductor, Two-Hole, Long Barrel with Corona Relief Taper Lug	D2.56
Code Conductor, Blank Tongue, Long Barrel Lug	D2.57
Code Conductor, Blank Tongue, Long Barrel with Window Lug	D2.58
Code Conductor, Short Barrel, Butt Splice	D2.59
Code Conductor, Standard Barrel, Butt Splice	D2.60
Code Conductor, Long Barrel, Butt Splice	D2.61
Code Conductor, Long Barrel with Corona Relief Taper Splice	D2.62
Code Conductor, Long Barrel, T Splice	D2.63
★ Code Conductor, Color-Coded Parallel Splice	D2.64
Copper Compression Parallel Splice	D2.65
Flex Conductor, One-Hole, Standard Barrel with Window Lug	D2.66 – D2.67
Flex Conductor, One-Hole, Standard Barrel with Window Lug, 45° Angle	D2.68 – D2.69
Flex Conductor, One-Hole, Standard Barrel with Window Lug, 90° Angle	D2.70 – D2.71
Flex Conductor, One-Hole, Standard Barrel with Window, Narrow Tongue Lug	D2.72

★ Represents new product offering.

A.	System Overview
B1.	Cable Ties
B2.	Cable Accessories
B3.	Stainless Steel Ties
C1.	Wiring Duct
C2.	Surface Raceway
C3.	Abrasion Protection
C4.	Cable Management
D1.	Terminals
D2.	Power Connectors
D3.	Grounding Connectors
E1.	Labeling Systems
E2.	Labels
E3.	Pre-Printed & Write-On Markers
E4.	Permanent Identification
E5.	Lockout/Tagout & Safety Solutions
F.	Index

Table of Contents

A.
System
Overview

B1.
Cable Ties

B2.
Cable
Accessories

B3.
Stainless
Steel Ties

C1.
Wiring
Duct

C2.
Surface
Raceway

C3.
Abrasion
Protection

C4.
Cable
Management

D1.
Terminals

D2.
Power
Connectors

D3.
Grounding
Connectors

E1.
Labeling
Systems

E2.
Labels

E3.
Pre-Printed
& Write-On
Markers

E4.
Permanent
Identification

E5.
Lockout/
Tagout
& Safety
Solutions

F.
Index

Flex Conductor, One-Hole, Standard Barrel with Window, Narrow Tongue Lug, 45°	D2.72
Flex Conductor, One-Hole, Standard Barrel with Window, Narrow Tongue Lug, 90°	D2.73
Flex Conductor, One-Hole, Standard Barrel with Window, Flared NEBS Lug	D2.74 – D2.75
Flex Conductor, One-Hole, Standard Barrel with Window, Flared NEBS Lug, 45° Angle	D2.76 – D2.77
Flex Conductor, One-Hole, Standard Barrel with Window, Flared NEBS Lug, 90° Angle	D2.78 – D2.79
Flex Conductor, One-Hole, Long Barrel with Window Lug	D2.80
Flex Conductor, One-Hole, Long Barrel with Window Lug, 45° Angle	D2.81
Flex Conductor, One-Hole, Long Barrel with Window Lug, 90° Angle	D2.82
Flex Conductor, Two-Hole, Standard Barrel with Window Lug	D2.83 – D2.84
Flex Conductor, Two-Hole, Standard Barrel with Window Lug, 45° Angle	D2.85 – D2.86
Flex Conductor, Two-Hole, Standard Barrel with Window Lug, 90° Angle	D2.87 – D2.88
Flex Conductor, Two-Hole, Standard Barrel with Window, Narrow Tongue Lug	D2.89
Flex Conductor, Two-Hole, Standard Barrel with Window, Narrow Tongue Lug, 45°	D2.90
Flex Conductor, Two-Hole, Standard Barrel with Window, Narrow Tongue Lug, 90°	D2.90
Flex Conductor, Two-Hole, Long Barrel with Window Lug	D2.91 – D2.92
Flex Conductor, Two-Hole, Long Barrel with Window Lug, 45° Angle	D2.93 – D2.94
Flex Conductor, Two-Hole, Long Barrel with Window Lug, 90° Angle	D2.95 – D2.96
Flex Conductor, Two-Hole, Long Barrel, Flared NEBS Lug	D2.97 – D2.98
Flex Conductor, Two-Hole, Long Barrel, Flared NEBS Lug, 45° Angle	D2.99 – D2.100
Flex Conductor, Two-Hole, Long Barrel, Flared NEBS Lug, 90° Angle	D2.101 – D2.102
Flex Conductor, Standard Barrel, Flared, NEBS Butt Splice	D2.103
Code/Flex Conductor, with Window, In-Line Reducing Splice Kit	D2.104 – D2.105
Code/Flex Conductor, with Window, In-Line Reducing Splice	D2.106 – D2.107
Part Number System for Metric Lugs	D2.108
★ Metric Conductor, One-Hole, Standard Barrel with Window Lug	D2.108 – D2.109
★ Metric Conductor, Two-Hole, Standard Barrel with Window Lug	D2.110 – D2.111
★ Metric Conductor, Standard Barrel, Butt Splice	D2.112
PANDUIT Custom Copper Compression Lugs for Special Applications	D2.113
Custom Lugs Spec Sheet Instructions	D2.114
Custom Lugs Preliminary Spec Sheet	D2.115
Code Conductor, One-Hole, Aluminum Lug	D2.116
Code Conductor, Two-Hole, Aluminum Lug	D2.117
Belleville Compression Washers	D2.118
Code Conductor, Aluminum Splice	D2.119
Code Conductor, Aluminum, Reducing Splice	D2.120
Code Conductor, Aluminum, Bi-Metallic Pin Connector	D2.121
Code Conductor, Aluminum HTAP	D2.122
Black Covers for Copper CTAPs and Aluminum HTAPs	D2.123
Joint Compounds	D2.123
PAN-LUG™ Mechanical Connectors	D2.125
Features and Benefits – PAN-LUG™ Mechanical Connectors	D2.126
Selection Guide – PAN-LUG™ Mechanical Connectors, Cast Copper	D2.127
Selection Guide – PAN-LUG™ Mechanical Connectors, Stamped and Formed	D2.128
Selection Guide – PAN-LUG™ Mechanical Connectors, Aluminum	D2.129
Selection Guide – PAN-LUG™ Mechanical Connectors, Split Bolts and Multi-Taps	D2.130
Split Bolt, Copper	D2.131
Split Bolt, Copper, Tin-Plated	D2.132
Split Bolt, Aluminum	D2.133
Two-Bolt Connector, Bronze	D2.133
Two-Bolt Connector, Bronze, Tin-Plated	D2.134
One-Hole, Straight Tongue, Barrel Post Lug	D2.134
One-Hole, Straight Tongue, Tin-Plated, Barrel Post Lug	D2.135
One-Hole, Straight Tongue Lug	D2.135
One-Hole, Straight Tongue Lug with Internal Pressure Plate	D2.136
One-Hole, Straight Tongue, Flag Lug	D2.136
One-Hole, Straight Tongue, 90° Lug	D2.137
Two-Hole, Straight Tongue Lug	D2.137
Two-Hole, Straight Tongue Lug with Internal Pressure Plate	D2.138
Two-Hole, Straight Tongue Lug with NEMA Hole Sizes and Spacing	D2.139
Two-Hole, Straight Tongue, Tandem Set Screw Lug	D2.139
Two-Hole, Straight Tongue, Two-Barrel Lug	D2.140
Two-Hole, Straight Tongue, Two-Barrel, Tin-Plated Lug	D2.140
Two-Set Screw Splice	D2.141
Two-Set Screw Splice with Internal Pressure Plate	D2.141
One-Hole, Straight Fixed Tongue Lug	D2.142
One-Hole, Straight Fixed Tongue, Tin-Plated Lug	D2.142
One-Hole, Straight Floating Tongue Lug	D2.143
Two-Hole, Straight Floating Tongue Lug	D2.144
One-Hole, Offset Floating Tongue Lug	D2.145
One-Hole, Offset Floating Tongue, Two-Barrel Lug	D2.145

★ Represents new product offering.

Table of Contents

Two-Hole, Offset Floating Tongue Lug	D2.146
One-Hole, Single Barrel Lug	D2.147
Two-Hole, Single Barrel Lug	D2.148
One-Hole, Two-Barrel Lug	D2.148
One-Hole, Vertical Two-Barrel Lug	D2.149
Two-Hole, Two-Barrel Lug	D2.149
Two-Hole, Vertical Two-Barrel Lug	D2.150
Two-Hole, Three-Barrel Lug	D2.150
Two-Hole, Vertical Three-Barrel Lug	D2.151
Four-Hole, Three-Barrel Lug	D2.151
Two-Hole, Vertical Four-Barrel Lug	D2.152
Four-Hole, Four-Barrel Lug	D2.152
Transformer Lug Kit	D2.153
Splicer/Reducer	D2.154
Multi-Tap Connector with Clear Insulation, Single-Sided	D2.155
Multi-Tap Connector with Clear Insulation, Double-Sided	D2.156 – D2.157
In-Line Splicer/Reducer with Clear Insulation	D2.158
Multi-Tap Connector with Clear Insulation, Single-Sided, with Mounting Holes	D2.159
Multi-Tap Connector with Clear Insulation, Double-Sided, with Mounting Holes	D2.160
Belleville Compression Washers	D2.161
Joint Compounds	D2.161
Guidelines for Installing Aluminum Mechanical Connectors	D2.162
PANDUIT Power Connector Approvals	D2.163
Recommended Termination Hardware	D2.164
Conductor Sizes	D2.165 – D2.167
Common Conductor Sizes and Strandings Reference Chart	D2.168 – D2.169
Stud Size Chart (Inches/Millimeters)	D2.170
Equivalent Tables	D2.171

Grounding Connectors

STRUCTUREDGROUND™ Grounding Connectors	D3.1
Features and Benefits – STRUCTUREDGROUND™ Compression Connectors	D3.2
Service Entrance Grounding Roadmap	D3.3
★ Access Floor Grounding Clamp	D3.4
BICSI/J-STD-607-A Telecommunications Grounding Busbars	D3.5
Component Labels for BICSI/J-STD-607-A Telecommunications Grounding Busbars	D3.5
Telecommunications Grounding and Bonding Conductor Label Kit	D3.5
Code Conductor, Thin Wall, CTAP	D3.6
Code Conductor, Heavy Duty, CTAP	D3.7
Clear Covers for HTCT HTAPs	D3.8
Black Covers for Copper CTAPs and Aluminum HTAPs	D3.8
Code/Flex Conductor HTAP	D3.9 – D3.10
Code/Flex Conductor HTAP Kit	D3.11 – D3.12
Features and Benefits – STRUCTUREDGROUND™ Mechanical Connectors	D3.13
Selection Guide – STRUCTUREDGROUND™ Mechanical Connectors	D3.14 – D3.15
PANDUIT Grounding Connector Approvals	D3.16
Service Post Connector, Male Stud, Single Conductor, Bronze	D3.17
Service Post Connector, Male Stud, Two Conductor, Bronze	D3.18
Service Post Connector, Female Thread, Single Conductor, Bronze	D3.19
Service Post Connector, Female Thread, Two Conductor, Bronze	D3.20
★ One-Hole Aluminum Lay-In Lug	D3.21
Joint Compounds	D3.21
Grounding Clamp, U-Bolt, Bronze	D3.22
Grounding Clamp, U-Bolt, for Two Cables, Bronze	D3.23
Grounding Clamp for Water Pipes, Bronze	D3.23
Grounding Clamp for Water Pipe with Copper Strap, Bronze	D3.24
Grounding Clamp for Conduit, Bronze	D3.24
Grounding Clamp for Water Pipes, Aluminum	D3.25
Grounding Rod Clamp, Bronze	D3.25
Grounding Clamp with Spacer for Flat Surfaces, Bronze	D3.26
Grounding Clamp for Flat Surfaces, Bronze	D3.26
Compression Connector Crimping Tools	D3.27
Crimping Guidelines for PANDUIT® PAN-LUG™ Compression Lugs and Splices	D3.28
Crimping Guidelines for PANDUIT® STRUCTUREDGROUND™ Compression Connectors	D3.29
Selection Guide – Compression Connector Tools	D3.30 – D3.32
Die Type, Manual, Crimping Tool	D3.33
CD-720 Crimping Dies	D3.33
Die Type, Manual, Crimping Tool and Die Kits	D3.34
Cable Stripping Tool for Large Cable Sizes	D3.34

★ Represents new product offering.

A. System Overview
B1. Cable Ties
B2. Cable Accessories
B3. Stainless Steel Ties
C1. Wiring Duct
C2. Surface Raceway
C3. Abrasion Protection
C4. Cable Management
D1. Terminals
D2. Power Connectors
D3. Grounding Connectors
E1. Labeling Systems
E2. Labels
E3. Pre-Printed & Write-On Markers
E4. Permanent Identification
E5. Lockout/Tagout & Safety Solutions
F. Index

Table of Contents

A. System Overview	
B1. Cable Ties	Wire and Cable Stripping Tools D3.34 Die Type, Manual Hydraulic, 14 Ton, Crimping Tool D3.35 Die Type, Battery Powered Hydraulic, 6 Ton, Crimping Tool with Closed Head D3.36 Die Type, Battery Powered Hydraulic, 6 Ton, Crimping Tool with Open “C-Head” D3.37
B2. Cable Accessories	CD-2001 Crimping Dies D3.38 Die Type, Battery Powered Hydraulic, 12 Ton, Crimping Tool D3.39 Die Type, Battery Powered Hydraulic, 15 Ton, Crimping Tool D3.40 Die Type, Remote Hydraulic, 14 Ton, Crimp Head D3.41 Die Type, Remote Hydraulic, 15 Ton, Crimp Head D3.42
B3. Stainless Steel Ties	Hydraulic Pump and Accessories, Electric, 10,000 PSI D3.43 Die Type, Remote Hydraulic, 10.5 Ton, Crimp Head D3.44 Hydraulic Pump and Accessories, Electric, 7,500 PSI D3.45 CD-920 Crimping Dies D3.46 CD-940 Crimping Dies D3.47
C1. Wiring Duct	UNI-DIE™ Dieless, Manual Hydraulic, 6.2 Ton, Crimping Tool D3.48 UNI-DIE™ Dieless, Battery Powered Hydraulic, 6.2 Ton, Crimping Tool, 12 VDC D3.49 UNI-DIE™ Dieless, Remote Hydraulic, 6.2 Ton, Crimp Head D3.50 UNI-DIE™ Dieless, Remote Hydraulic, 4.7 Ton, Crimp Head D3.50
C2. Surface Raceway	Pressure Gauges D3.51 Accessories for Battery Powered Hydraulic Crimping Tools D3.51 Installation Tooling and Die Selections for: Types LCAS and SCSS D3.52 – D3.53 Installation Tooling and Die Selections for: Types LCA, LKAN, LCD, LCDN and SCS D3.54 – D3.57 Installation Tooling and Die Selections for: Types LCB, LCBN, LCC, LCCN and SCL D3.58 – D3.61 Installation Tooling and Die Selections for: Types LCBH, LCCH and SCH D3.62 – D3.63 Installation Tooling and Die Selections for: Type SCT D3.64 – D3.65 Installation Tooling and Die Selections for: Types LCAX, LCAXN, LCBX, LCDX, LCDXN and LCCX D3.66 – D3.69 Installation Tooling and Die Selections for: Types LCAF, LCCF and SCSF D3.70 – D3.71 Installation Tooling and Die Selections for: Type RSC In-Line Reducing Splice D3.72 – D3.77
C3. Abrasion Protection	Installation Tooling and Die Selections for: Type PSC D3.78 Installation Tooling and Die Selections for: Type LCMA, LCMD, and SCMS D3.79 Installation Tooling and Die Selections for: Types LAA, LAB and SA D3.80 – D3.81 Installation Tooling and Die Selections for: Type SAR D3.82 – D3.83 Installation Tooling and Die Selections for: Type BPC D3.84 – D3.85 Installation Tooling and Die Selections for: Type HTAP D3.86 Installation Tooling and Die Selections for: Type HTCT D3.87 Installation Tooling and Die Selections for: Type CTAPP D3.88 – D3.89 Installation Tooling and Die Selections for: Type CTAP D3.90
C4. Cable Management	
D1. Terminals	
D2. Power Connectors	
D3. Grounding Connectors	
E1. Labeling Systems	
E2. Labels	
E3. Pre-Printed & Write-On Markers	
E4. Permanent Identification	
E5. Lockout/ Tagout & Safety Solutions	
F. Index	

Labeling Systems

Labeling Systems	E1.0
Printers: Thermal Transfer Desktop and Hand-Held	E1.1
★ PANTHER™ LS8E Hand-Held Thermal Transfer Printer and Accessories	E1.2
★ COUGAR™ LS9 Hand-Held Thermal Transfer Printer and Accessories	E1.2
P1™ Self-Laminating Label Cassettes for PANTHER™ LS8E Hand-Held Thermal Transfer Printer	E1.3 – E1.4
Part Number System for Wire/Cable Labeling	E1.3, E1.5, E1.7
P1™ Non-Laminated Label Cassettes	E1.5
P1™ Military Grade Continuous Heat Shrink Label Cassettes for PANTHER™ LS8E or COUGAR™ LS9 Hand-Held Thermal Transfer Printers	E1.6
P1™ Military Grade Die-Cut Heat Shrink Label Cassettes for PANTHER™ LS8E Hand-Held Thermal Transfer Printer	E1.7
P1™ General Component Label Cassettes for PANTHER™ LS8E Hand-Held Thermal Transfer Printers	E1.8
Part Number System for Component Labeling	E1.8
P1™ Continuous Tape Cassettes for PANTHER™ LS8E and COUGAR™ LS9 Hand-Held Thermal Transfer Printers	E1.9 – E1.10
Part Number System for Continuous Tapes	E1.9
TDP43MY Thermal Transfer Desktop Printer and Accessories	E1.11
Ribbons for Use with the TDP43MY Thermal Transfer Desktop Printer	E1.11
TDP42HY, TDP43HY, TDP46HY Thermal Transfer Desktop Printers	E1.12
Ribbons for use with the TDP42HY, TDP43HY and TDP46HY Thermal Transfer Desktop Printers	E1.12
Labeling Software	E1.13
EASY-MARK™ Labeling Software	E1.14
CAD-CONNECT™ Labeling Software	E1.14

Labels

Labels: Laser, Ink Jet, Thermal Transfer and Dot Matrix	E2.1
Laser/Ink Jet Self-Laminating Labels	E2.2
Laser/Ink Jet Non-Laminated Labels	E2.3
Part Number System for Non-Laminated Labels	E2.3

★ Represents new product offering.

Table of Contents

A.	System Overview
B1.	Cable Ties
B2.	Cable Accessories
B3.	Stainless Steel Ties
C1.	Wiring Duct
C2.	Surface Raceway
C3.	Abrasion Protection
C4.	Cable Management
D1.	Terminals
D2.	Power Connectors
D3.	Grounding Connectors
E1.	Labeling Systems
E2.	Labels
E3.	Pre-Printed & Write-On Markers
E4.	Permanent Identification
E5.	Lockout/Tagout & Safety Solutions
F.	Index

Laser/Ink Jet Flag Style Labels	E2.4
Laser/Ink Jet Component Labels	E2.4 – E2.5
Part Number System for Component Labels	E2.4
Thermal Transfer Self-Laminating Labels	E2.6 – E2.8
Part Number System for Self-Laminating Labels	E2.6
Thermal Transfer Marker Plates	E2.9
Thermal Transfer Non-Laminated Labels	E2.10
Part Number System for Non-Laminated Labels	E2.10
Thermal Transfer Commercial Grade Heat Shrink Labels	E2.11 – E2.12
Part Number System for Heat Shrink Labels	E2.11
Thermal Transfer Military Grade Heat Shrink Labels	E2.13 – E2.14
Part Number System for Heat Shrink Labels	E2.13
Heat Shrink Tools and Accessories	E2.14
Thermal Transfer Component Labels	E2.15 – E2.17
Part Number System for Component Labels	E2.15
Thermal Transfer Continuous Tapes	E2.18 – E2.19
Part Number System for Continuous Tapes	E2.18
Dot Matrix Self-Laminating Labels	E2.20 – E2.21
Part Number System for Self-Laminating Labels	E2.20
Dot Matrix Non-Laminated Labels	E2.22
Part Number System for Non-Laminated Labels	E2.22
Dot Matrix Flag Style Labels	E2.23
Dot Matrix Component Labels	E2.23 – E2.24
Size Illustrations of Self-Laminating Labels	E2.25 – E2.26
Size Illustrations of Non-Laminated and Flag Style Labels	E2.27
Size Illustrations of Flattened Heat Shrink Labels	E2.28
Size Illustrations for Component Labels	E2.29 – E2.30

Pre-Printed and Write-On Markers

Pre-Printed and Write-On Markers	E3.1
Pre-Printed Marker Books	E3.2
Pre-Printed Marker Books – Self-Laminating	E3.3
Pre-Printed Marker Cards PCM Type	E3.4 – E3.6
Wire Marker Card Number Combination Packs	E3.6
Pre-Printed Marker Cards	E3.7
Pre-Printed Marker Cards PPM Type	E3.8
Write-On Marker Cards – Self-Laminating	E3.9
Pre-Printed Marker Tape Dispenser	E3.9
Pre-Printed Marker Tape Refills	E3.10
Self-Laminating Wire Marker Dispenser	E3.11
Pre-Printed Clip-On Wire Markers	E3.11 – E3.12

Permanent Identification

Permanent Identification	E4.1
PANDUIT Factory Custom Marking Service	E4.2
Stainless Steel and Brass Marker Plates and Tags	E4.3 – E4.4
★ PAN-ALUM™ Aluminum Marker Plates	E4.5
Metal Embossing Tool and Tape System	E4.5
★ Metal Indenting Machine	E4.6
Marker Stamp Kit	E4.6

Lockout/Tagout and Safety Solutions

Lockout/Tagout	E5.1
OSHA Lockout/Tagout Compliance Manual	E5.2
Lockout/Tagout Regulations Training Video and Handbooks	E5.2
Group Lockout/Tagout Training Video	E5.2
Lockout/Tagout Steps/Calendar Wallet Card	E5.3
Circuit Breaker Lockout Devices	E5.3
“No Tool” Circuit Breaker Lockout Devices	E5.3
Large Handle Circuit Breaker Lockout Device	E5.4
Plug Lockout Device	E5.4
Cord Lockout Devices	E5.4
Receptacle Blockout Device	E5.5
Toggle Switch Lockout Device	E5.5
Toggle/Rocker Switch Lockout Device	E5.5
Gate Valve Lockout Devices	E5.5
Ball Valve Lockout Devices	E5.6

★ Represents new product offering.

Table of Contents

A.
System
Overview

B1.
Cable Ties

B2.
Cable
Accessories

B3.
Stainless
Steel Ties

C1.
Wiring
Duct

C2.
Surface
Raceway

C3.
Abrasion
Protection

C4.
Cable
Management

D1.
Terminals

D2.
Power
Connectors

D3.
Grounding
Connectors

E1.
Labeling
Systems

E2.
Labels

E3.
Pre-Printed
& Write-On
Markers

E4.
Permanent
Identification

E5.
Lockout/
Tagout
& Safety
Solutions

F.
Index

Multiple Lockout Device	E5.6
Pneumatic Energy Lockout Device	E5.6
★ Jack Module Blockout Device	E5.7
★ RJ45 Plug Lockin Device	E5.7
Electrician Lockout Kit	E5.8
Contractor Lockout Kit	E5.8
MRO Lockout Kit	E5.8
Power and Panel Distribution Lockout Kit	E5.8
Metal Wall Mount Cabinet	E5.9
Lockout Stations	E5.9
Group Lock Box	E5.9
Warning Label	E5.10
Circuit Breaker Directory Sign	E5.10
Safety Lockout Padlocks	E5.11
High Security Padlocks	E5.11
Laminated Steel Padlocks	E5.12
Value Line Padlocks	E5.12
Lockout Hasps	E5.13
Self-Laminating Padlock Labels	E5.13
Custom Lock Options	E5.13
Metal I.D. Tags and Collars	E5.14
Padlock Eyes	E5.14
Chain Attachment	E5.14
Write-On Safety Tags	E5.15 – E5.17
Bilingual Write-On Safety Tags	E5.18
ISO Symbol Safety Tags	E5.18
Do It Yourself Tags	E5.18
Self-Laminating Photo Tags	E5.19
Permanent Marking Pens	E5.20
Lockout/Tagout Safety Signs	E5.20
Safety and Facility Identification	E5.21
Electrical Hazard Safety Signs	E5.22
★ Short Circuit Warning Signs	E5.23
★ Photoluminescent Safety Signs	E5.23
Electrical Symbols on Cards	E5.23
Conductor Identification Labels	E5.24
ISO Warning Symbols	E5.25
Electrical Labels in Dispenser	E5.26
Write-On Labels on Cards	E5.27
Write-On Quality Labels in Dispenser	E5.28
Inspection Plates	E5.29
Inspection Arrows	E5.29
Voltage and Fiber Optic Markers	E5.30
Voltage and Safety Marker Books	E5.31
Hazard Tape	E5.31
Solid Color Adhesive Warning Tape	E5.32
Photoluminescent Tapes – Thermal Transfer Printable	E5.32
Underground Hazard Tape	E5.33
Barricade Tapes	E5.34
Vinyl Letters and Numbers	E5.34
Vinyl Cloth Letters and Numbers	E5.35 – E5.36
Reflective Letters and Numbers	E5.36
Sign Panels – Blank Space for Custom Messages	E5.37
★ Thermal Transfer Printable Arc Flash Labels	E5.38
★ Laser Printable Adhesive Signs	E5.38
Self-Laminating Adhesive Sign Carriers	E5.39
Self-Laminating Cable Marker Holders for Large Cables or Cable Bundles	E5.39
Self-Laminating Fiber Optic Cable Marker Tags	E5.40
Ground Warning Tags	E5.40
PANDUIT Corp. Generic Lock Order Form	E5.41
PANDUIT Corp. Generic PVT Vinyl Tag Order Form	E5.42
PANDUIT Corp. Generic Adhesive PPS Safety Sign Order Form	E5.43
PANDUIT Corp. Generic Semi-Rigid PRS Safety Sign Order Form	E5.44
PANDUIT Corp. Generic Conduit and Voltage Marker Order Form	E5.45
PANDUIT Corp. Generic Utility Tapes Order Form	E5.46
Wire Size Selection Guide	E5.47
Selection Guide by Wire/Cable Size	E5.48

Index

Part Number Index	F1.1 – F1.36
--------------------------	--------------

★ Represents new product offering.

SYSTEM OVERVIEW

PANDUIT is a global leader in wiring and communication products. Comprehensive solutions include everything necessary to bundle, identify, route, protect and terminate wires/cables. Supporting the most demanding application requirements customers trust *PANDUIT* for:



PANDUIT products are developed through continued focus on the needs of the customer and high level of investment in research and development. Solutions are designed for reliability, improved productivity, standards compliance and lowest total cost of ownership.

- Comprehensive, end-to-end solutions
- World-class quality and reliability
- Innovative products and tools
- Unmatched global sales and technical support

A.
System
Overview

B1.
Cable Ties

B2.
Cable
Accessories

B3.
Stainless
Steel Ties

C1.
Wiring
Duct

C2.
Surface
Raceway

C3.
Abrasion
Protection

C4.
Cable
Management

D1.
Terminals

D2.
Power
Connectors

D3.
Grounding
Connectors

E1.
Labeling
Systems

E2.
Labels

E3.
Pre-Printed
& Write-On
Markers

E4.
Permanent
Identification

E5.
Lockout/
Tagout
& Safety
Solutions

F.
Index

A.
System
Overview

SOLUTIONS OVERVIEW

PANDUIT provides innovative solutions that offer maximum reliability at the lowest installed cost from the factory and manufacturing floor, to automation and control, to the office area.

B1.
Cable Ties

B2.
Cable
Accessories

B3.
Stainless
Steel Ties

C1.
Wiring
Duct

C2.
Surface
Raceway

C3.
Abrasion
Protection

C4.
Cable
Management

D1.
Terminals

D2.
Power
Connectors

D3.
Grounding
Connectors

E1.
Labeling
Systems

E2.
Labels

E3.
Pre-Printed
& Write-On
Markers

E4.
Permanent
Identification

E5.
Lockout/
Tagout/
& Safety
Solutions

F.
Index



Industrial



MRO



Oil and Gas



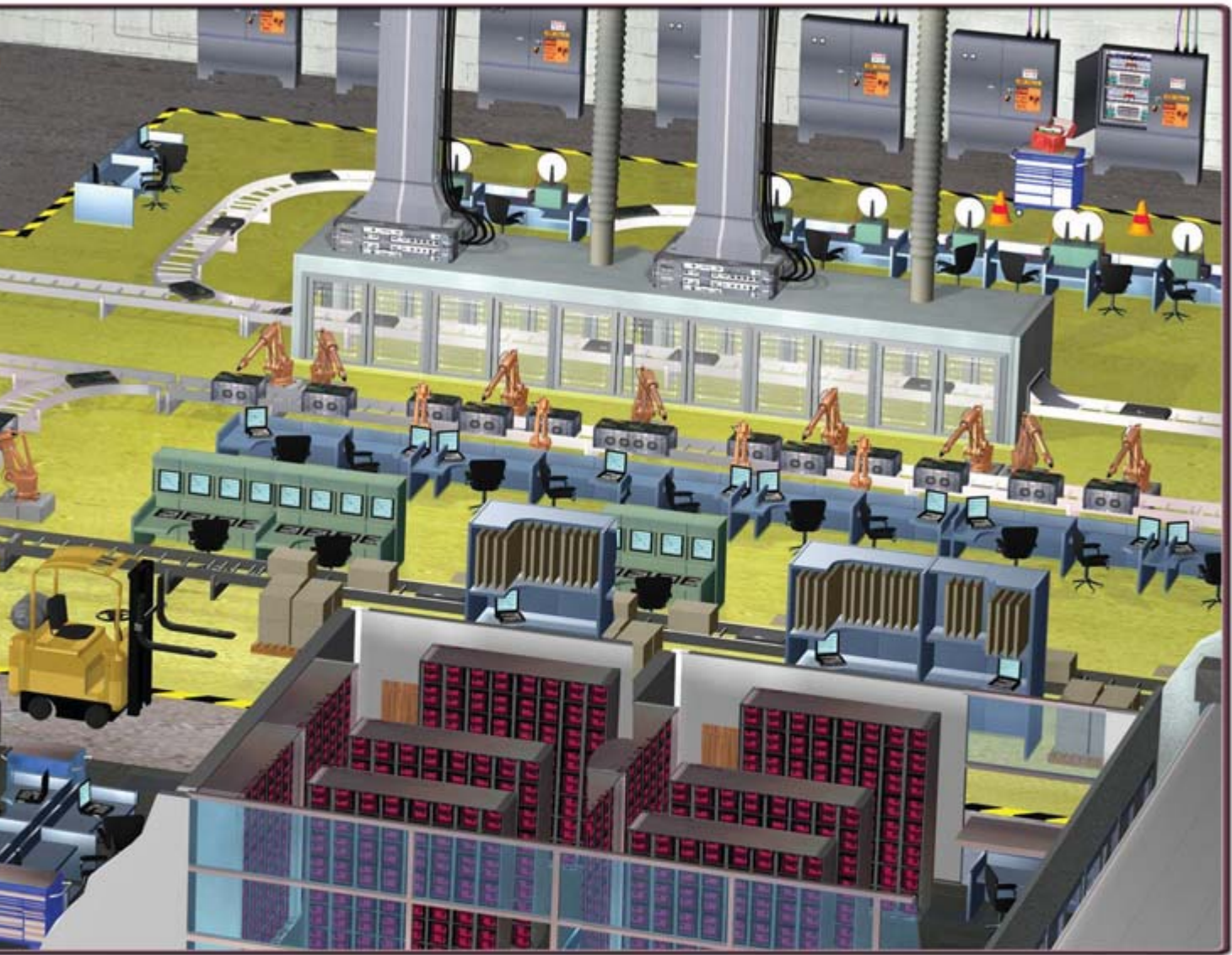

A.
System
Overview

B1.
Cable Ties

B2.
Cable
Accessories

B3.
Stainless
Steel Ties

C1.
Wiring
Duct

C2.
Surface
Raceway

C3.
Abrasion
Protection

C4.
Cable
Management

D1.
Terminals

D2.
Power
Connectors

D3.
Grounding
Connectors

E1.
Labeling
Systems

E2.
Labels

E3.
Pre-Printed
& Write-On
Markers

E4.
Permanent
Identification

E5.
Lockout/
Tagout/
& Safety
Solutions

F.
Index

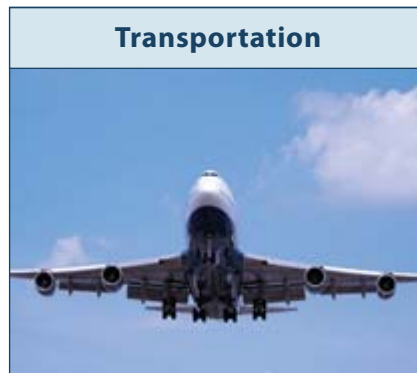

A.
System
Overview

CONTROL PANEL SOLUTIONS

PANDUIT delivers innovative solutions that support evolving technologies in automation and control. Control panel solutions from PANDUIT reduce design and assembly time, save valuable panel space, ease installation and maintenance, and improve manageability and reliability, all contributing to lower cost of ownership.

B1.
Cable Ties

B2.
Cable
Accessories

B3.
Stainless
Steel Ties

C1.
Wiring
Duct

C2.
Surface
Raceway

C3.
Abrasion
Protection

C4.
Cable
Management

D1.
Terminals

D2.
Power
Connectors

D3.
Grounding
Connectors

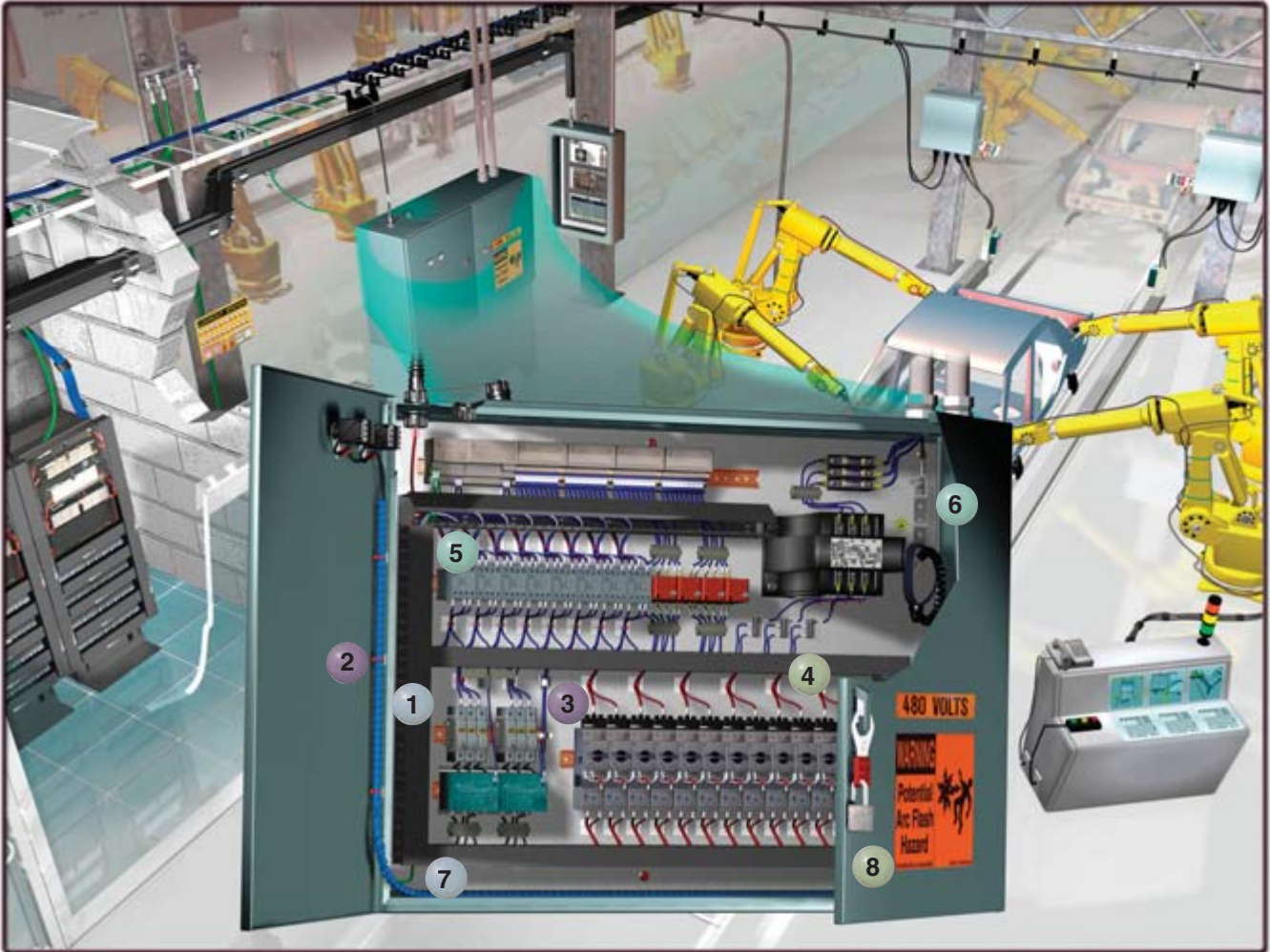

E1.
Labeling
Systems

E2.
Labels

E3.
Pre-Printed
& Write-On
Markers

E4.
Permanent
Identification

E5.
Lockout/
Tagout/
& Safety
Solutions

F.
Index

1 **Wiring Duct**

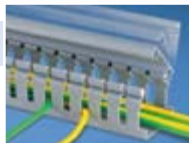

2 **Cable Ties**



3 **Cable Accessories**



4 **Labeling Systems**



5 **Terminals**



6 **Power and
Grounding
Connectors**



7 **Abrasion
Protection**



8 **Lockout/
Tagout**



For INDUSTRIALNET™ Solution, request SA-CPCB10 or visit www.panduit.com.

HARNESS SOLUTIONS

PANDUIT is a leading supplier of wire management solutions, helping OEM and CMs achieve their strategic objectives. From complete system solutions that provide the lowest installed cost to new product innovations that meet evolving application challenges, PANDUIT solutions meet a wide range of applications, volumes, and environments in white goods, gaming, vending and transportation.

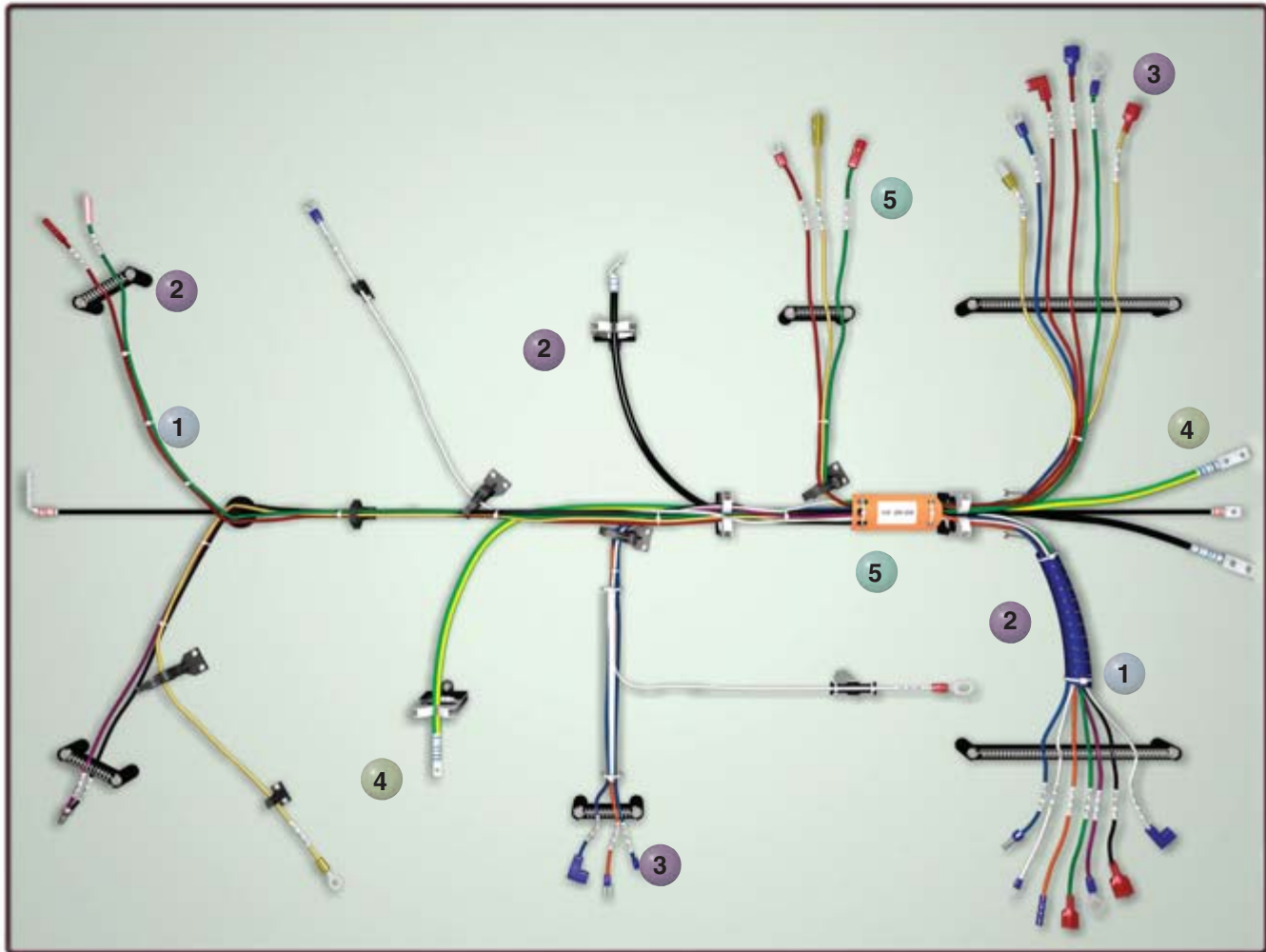

1 Cable Tie Systems



2 Cable Accessories



3 Terminal Systems



4 Power Connector Systems



5 Identification Systems



A.
System
Overview

B1.
Cable Ties

B2.
Cable
Accessories

B3.
Stainless
Steel Ties

C1.
Wiring
Duct

C2.
Surface
Raceway

C3.
Abrasion
Protection

C4.
Cable
Management

D1.
Terminals

D2.
Power
Connectors

D3.
Grounding
Connectors

E1.
Labeling
Systems

E2.
Labels

E3.
Pre-Printed
& Write-On
Markers

E4.
Permanent
Identification

E5.
Lockout/
Tagout
& Safety
Solutions

F.
Index

A.
System
Overview

B1.
Cable Ties

B2.
Cable
Accessories

B3.
Stainless
Steel Ties

C1.
Wiring
Duct

C2.
Surface
Raceway

C3.
Abrasion
Protection

C4.
Cable
Management

D1.
Terminals

D2.
Power
Connectors

D3.
Grounding
Connectors

E1.
Labeling
Systems

E2.
Labels

E3.
Pre-Printed
& Write-On
Markers

E4.
Permanent
Identification

E5.
Lockout/
Tagout
& Safety
Solutions

F.
Index

CONTRACTOR SOLUTIONS



PANDUIT is committed to delivering innovative solutions that meet the needs of electrical and networking installations. Contractors rely on *PANDUIT* solutions for improved productivity, reliability, and safety with lower installed costs. A comprehensive range of products and tooling satisfies the most demanding applications and environments. Contractor programs further support your business needs and benefit the bottom line.

MRO SOLUTIONS



Maximizing facility uptime while containing maintenance and repair costs is a big challenge facing industrial and manufacturing facilities. Electrical and control systems repair, reconfiguration, and preventative maintenance comprise a substantial portion of the total facility spend. *PANDUIT* solutions deliver best-in-class quality for maximum reliability and defect-free installations, minimizing rework and reducing downtime. The breadth of product lines and materials selection provides extensive application and environment-specific solutions for faster, easier, and more cost-effective maintenance and repair operations (MRO).



HARSH ENVIRONMENT SOLUTIONS

When vibration, radiation, weathering, corrosion and temperature extremes are a factor, you need a high quality, reliable, and durable solution. *PANDUIT* provides everything necessary to bundle, route, protect, terminate and identify electrical and network cable in indoor and outdoor extreme conditions. These innovative solutions meet the needs of the most demanding harsh and industrial environment applications to deliver long life, increased productivity, and improved worker safety.



TRANSPORTATION SOLUTIONS

PANDUIT develops high-quality products to meet the requirements of the transportation market while providing the lowest installed cost. Performance, reliability, efficiency and availability are critical issues to success. *PANDUIT* solutions are designed to hold up under vibration, shock, and exposure to nature's elements while preventing corrosion, reducing weight, and speeding installation.

A.
System
Overview

B1.
Cable
Ties

B2.
Cable
Accessories

B3.
Stainless
Steel Ties

C1.
Wiring
Duct

C2.
Surface
Raceway

C3.
Abrasion
Protection

C4.
Cable
Management

D1.
Terminals

D2.
Power
Connectors

D3.
Grounding
Connectors

E1.
Labeling
Systems

E2.
Labels

E3.
Pre-Printed
& Write-On
Markers

E4.
Permanent
Identification

E5.
Lockout/
Tagout
& Safety
Solutions

F.
Index

APPLICATION STANDARDS

To help assure optimum quality, *PANDUIT* products are designed and manufactured to meet applicable environmental, safety, market industry and customer standards.

Restriction of Hazardous Substances (RoHS)

RoHS

The European Union (EU) directive on the Restriction of use of certain Hazardous Substances bans the use of six substances in electrical and electronic equipment within the European Economic Community (EEC) after July 1, 2006. The RoHS status of *PANDUIT* Electrical Products, shown in this catalog, can be determined by accessing www.panduit.com.

Underwriters Laboratories, Inc



Underwriters Laboratories, Inc. (UL) is an independent, not-for-profit product-safety testing and certification organization based in the United States. Since its founding in 1894, UL is becoming one of the most recognized, reputable conformity assessment providers in the world. Today, services extend to helping companies achieve global acceptance, whether for an electrical device, a programmable system, or an organization's quality process. Further information on UL marks can be found at www.ul.com/mark/.

Canadian Standards Association



The Canadian Standards Association is a not-for-profit membership based association serving business, industry, government and consumers in Canada and the global marketplace. CSA works in Canada and around the world to develop standards that enhance public safety and health. Additional information can be found at www.csa.ca.

Conformity European



CE marketing is required for certain products sold within the European Union (EU). EU Directives and Norms, specify the requirements for products. Applying the CE mark signifies compliance with those requirements.

ISO 9001



The International Standards Organization (ISO) establishes worldwide standards for products and services in recognition of increasing globalization of markets. The ISO program establishes the requirements for quality assurance systems. All *PANDUIT* component manufacturing facilities are third party registered to ISO 9001. Registration certificates are available from *PANDUIT*, www.panduit.com.

ISO/TS16949

ISO/TS16949 is a recognized supplier quality standard for the automotive industry. The ISO community of accreditation bodies and registrars considers these additions automotive "interpretations" to the global ISO 9001 standard. Appropriate *PANDUIT* locations are third party registered to this standard. Registration certificates are available from *PANDUIT*, www.panduit.com.

ISO 14001



ISO14001 is a voluntary standard for Environmental Management Systems established by the International Organization for Standardization. The international standard provides a benchmark for continual improvement in environmental performance. Business partners can be confident that *PANDUIT* manufacturing facilities around the globe are engaged in an ongoing process to maximize value while minimizing the impact on natural resources.

National Electrical Manufacturers Association (NEMA)

NEMA is the largest trade association in the U.S. representing electro-industry manufacturers. NEMA develops industry standards that are in the best interest of the industry and users of its products. NEMA standards for electrical power connector for substations covers uninsulated connectors and busbar supports which are made of metal and intended for use in substations. Included in the standard are manufacturing standards for bolt hole sizes and spacing for terminal connectors with single tangs. *PANDUIT* offers connectors that meet NEMA manufacturing standards and these are specially noted as listed within this catalog.

APPLICATION STANDARDS (continued)

Alliance for Telecommunications Industry Solutions (ATIS)



ATIS is a technical planning and standards development organization that is committed to rapidly developing and promoting technical and operations standards for the communications and related information technologies industry worldwide using a pragmatic, flexible, and open approach. Over 1,200 participants from more than 400 communications companies are active in ATIS' 22 industry committees, and its Incubator Solutions Program. Additional information can be found at www.atis.org.

J-STD-607-A-2002, Commercial Building Grounding (Earthing) and Bonding Requirements for Telecommunications is jointly developed by TIA/EIA and ATIS' technical committee T1E1. This document is available on the ATIS Document Center at www.atis.org.

Adhering to the grounding principles outlined in J-STD-607-A helps ensure that the telecommunications grounding and bonding system will perform acceptably regardless of the data and voice equipment installed. As stated in J-STD-607-A, the preferred means of connecting conductors to busbars is by using two-hole irreversible compression lugs listed by a nationally recognized testing laboratory (NRTL) such as UL. *PANDUIT PAN-LUG™* Copper Compression Connectors meet these requirements, in all barrel sizes specified by the 607 standard.

Telecommunications Industry Association (TIA)



The Telecommunications Industry Association is a leading US non-profit trade association serving the communications and information technology industry. TIA represents providers of communications and information technology products and services for the global marketplace through its core competencies in standards development.

ANSI/TIA-942 Telecommunications Infrastructure Standard for Data Centers covers a wide range of facilities issues, including grounding and bonding. It states that electrical continuity is required throughout the rack materials. Adhering to these principles protects network equipment and maintains system performance.

NEBS Level 3 Approval as Tested by Telcordia Technologies

Telcordia Technologies, formerly known as Bellcore, serves as the testing agency for the Regional Bell Operating Companies. Network Equipment-Building Systems (NEBS) was developed by Bellcore and is currently maintained by Telcordia Technologies. NEBS was developed to standardize requirements for Central Office Equipment and to develop criteria for personal safety, protection of property, and operational continuity.

NEBS Level 3 Criteria is the minimum level of environmental compatibility needed to provide maximum assurance of equipment operability within the network facility environment. The Level 3 criteria is the highest assurance of product operability. Products that meet NEBS Level 3 Criteria are suited for equipment applications which demand minimal service interruptions over the life span of the equipment. *PANDUIT* is the first in the industry to have a system of copper compression lugs and splices (#8 AWG – 1,000 kcmil) and crimping tools physically and rigorously tested by Telcordia Technologies to meet NEBS Level 3 compliance.

American Bureau of Shipping (ABS)



ABS is a not-for-profit organization that promotes the security of life, property, and the natural environment primarily through the development and verification of standards for the design, construction, and operational maintenance of marine related facilities including: merchant and naval vessels, offshore drilling units, submersibles, FPSOs, etc. *PANDUIT* has ABS Type Approval for select copper compression lugs and splices and are in compliance with ABS 2005 Steel Vessel Rules and can be installed on ABS Type Approved steel vessel machinery, electrical systems, and electrical equipment. *PANDUIT* products that meet ABS Type Approval can be found listed on the ABS website at www.typeapproval.org.

B1.
Cable Ties

B2.
Cable
Accessories

B3.
Stainless
Steel Ties

C1.
Wiring
Duct

C2.
Surface
Raceway

C3.
Abrasion
Protection

C4.
Cable
Management

D1.
Terminals

D2.
Power
Connectors

D3.
Grounding
Connectors

E1.
Labeling
Systems

E2.
Labels

E3.
Pre-Printed
& Write-On
Markers

E4.
Permanent
Identification

E5.
Lockout/
Tagout
& Safety
Solutions

F.
Index

PROGRAMS

PANDUIT maintains a dedicated global sales force of highly qualified industry experts to provide professional, consultative sales guidance. In addition, *PANDUIT* has partnered with best-in-class contractors and distributors to provide the services and support to deliver comprehensive, reliable solutions at the lowest installed cost.

Contractor Loyalty Incentive Program (CLIP)

The CLIP program was developed to strengthen relationships and form alliances with valued contractors. Use *PANDUIT* as your preferred vendor for cable ties, terminals, power connectors, identification products, surface raceway, installation tooling and a host of related products, and earn credit towards *PANDUIT* tooling.

Benefits of being a CLIP participant include annual credit incentives, continuous training, potential project leads, and alliance with a global, world-class electrical manufacturer and exclusive promotions.

For more program details, go to www.panduit.com/clip or contact *PANDUIT* Customer Service at 800-777-3300.

Tooling Partnership Program

The tooling Partnership Program is designed to make low-cost or no cost tooling available to the customer based on qualification and commitment to termination product purchases.

For more program details, go to www.panduit.com/tpp or contact *PANDUIT* Customer Service at 800-777-3300.

PC Express Program

PC Express offers the ultimate level of service for your power connector needs. PC Express is offered through select authorized *PANDUIT* distributors. The PC Express Program provides customers with the ability to receive power connector orders, via second day delivery, at no additional charge.

The customer can place an order of any size, up to a 300 lb. maximum weight, through an authorized *PANDUIT* distributor and *PANDUIT* will absorb the second day freight charges. All orders will be shipped directly to the customer. Orders received by *PANDUIT* Customer Service before 3:00 P.M. CST will be shipped on the same day, via second day delivery. Orders received after 3:00 P.M. CST will be shipped the next business day, via second day delivery.

For more program details, go to www.panduit.com/pcexpress or contact *PANDUIT* Customer Service at 800-777-3300.

Note: All programs and benefits are subject to terms and conditions.

CABLE TIES



PANDUIT offers the most complete selection of cable tie styles, sizes, materials and colors to meet our customers' needs. *PANDUIT* cable ties bundle, mount, and identify in countless indoor, outdoor, and harsh environment applications. *PANDUIT* cable ties, wiring accessories, and installation tools allow our customers to achieve the lowest total installed cost of managing wire and cable.



- *PANDUIT* continues to provide innovative new cable tie designs to meet our customers' application challenges
- *PANDUIT* cable ties and wiring accessories can be used in a variety of applications and environments, providing the optimal wire management solution
- *PANDUIT* offers a large selection of ergonomic cable tie installation tools – from high-speed automatic systems to hand operated tools; all with consistent, reliable performance



PANDUIT leads the industry in the breadth and depth of available cable tie designs created from customer feedback on their application requirements. As with all *PANDUIT* products, quality in design and production along with customer service excellence are assured.

A.
System
Overview

B1.
Cable
Ties

B2.
Cable
Accessories

B3.
Stainless
Steel Ties

C1.
Wiring
Duct

C2.
Surface
Raceway

C3.
Abrasion
Protection

C4.
Cable
Management

D1.
Terminals

D2.
Power
Connectors

D3.
Grounding
Connectors

E1.
Labeling
Systems

E2.
Labels

E3.
Pre-Printed
& Write-On
Markers

E4.
Permanent
Identification

E5.
Lockout/
Tagout
& Safety
Solutions

F.
Index

A.
System
Overview

Cable Tie Selection Chart

Follow this step-by-step process to find the cable ties that best suit your application:

Cable Tie Function
 1) Select the main function of the cable tie you need:
 Bundle = Standard Cable Ties
 Re-use = Nylon Releasable Ties*
 Identify = Marker and Flag Ties
 Mount = Clamp Ties, Push Mount Ties, and Stud Mount Ties

Material Properties
 2) Determine the appropriate material for your application:
 Mechanical
 Chemical
 Thermal

Cable Tie Family
 3) Select the cable tie family that meets your overall needs

B1.
Cable Ties

B2.
Cable
Accessories

B3.
Stainless
Steel Ties

C1.
Wiring
Duct

C2.
Surface
Raceway

C3.
Abrasion
Protection

C4.
Cable
Management

D1.
Terminals

D2.
Power
Connectors

D3.
Grounding
Connectors

E1.
Labeling
Systems

E2.
Labels

E3.
Pre-Printed
& Write-On
Markers

E4.
Permanent
Identification

E5.
Lockout/
Tagout
& Safety
Solutions

F.
Index

	Cable Tie Function	Test Method	Bundle, Re-use, Identify, Mount	Bundle, Re-use, Identify, Mount	Bundle, Re-use, Mount	Bundle, Re-use, Mount	Bundle	Bundle
C1. Wiring Duct	Material		Nylon 6.6	Weather Resistant Nylon 6.6	Impact Modified Weather Resistant Nylon 6.6	Heat Stabilized Nylon 6.6	Heat Stabilized Nylon 6.6	Heat Stabilized Weather Resistant Nylon 6.6
	Color	—	Natural (other colors available)	Black	Black	Black	Natural	Black
	Part Number Suffix (Material Designation)	—	No Suffix	0	0	30	39	300
C2. Surface Raceway	Tensile @ Yield @ 73°F(psi)	ISO 527	12,000	12,000	9,700	12,000	12,000	12,000
	Water Absorption (24 Hours)	ASTM D570	1.2%	1.2%	1.2%	1.2%	1.2%	1.2%
	Radiation Resistance (Rads)	—	1 x 10 ⁵	1 x 10 ⁵	1 x 10 ⁵	1 x 10 ⁵	1 x 10 ⁵	1 x 10 ⁵
C3. Abrasion Protection	Weathering Life Expectancy (Years)/UV Resistance	—	1 – 2	7 – 9	7 – 9	4 – 5	1 – 2	7 – 9
	Impact Resistance	—	○	○	⊖	○	○	○
	Salts	—	⊖	⊖	⊖	⊖	⊖	⊖
C4. Cable Management	Hydrocarbons (Gas, Oil, Lubricants)	—	●	●	●	●	●	●
	Chlorinated Hydrocarbons	—	⊖	⊖	⊖	⊖	⊖	⊖
	Acids	—	●	●	●	●	●	●
D1. Terminals	Bases	—	⊖	⊖	⊖	⊖	⊖	⊖
	Acid Rain	—	⊖	⊖	⊖	⊖	⊖	⊖
	Max. Continuous Use Temperature (Note 1)	UL 746B	185°F 85°C	185°F 85°C	185°F 85°C	239°F 115°C	239°F 115°C	212°F 100°C (Note 2)
D2. Power Connectors	Min. Application Use Temperature	EN 50146	-76°F -60°C	-76°F -60°C	-76°F -60°C	-76°F -60°C	-76°F -60°C	-76°F -60°C
	Flammability Rating (Note 4)	UL 94	V-2	V-2	HB	V-2	V-2	V-2
	Low Smoke	ASTM E662	PASS	PASS	PASS	PASS	PASS	PASS
D3. Grounding Connectors	Oxygen Index	BS ISO 4589	28	28	—	28	28	28
	Halogen-Free	IEC 60754-2	Yes	Yes	Yes	Yes	Yes	Yes
	Burning Fume Toxicity	BSS-7239	PASS	PASS	PASS	PASS	PASS	PASS
E1. Labeling Systems	Heat Deflection Temperature @ 1.8 Mpa	ASTM D648 ISO 75 -1/-2	158°F 70°C	158°F 70°C	145°F 63°C	158°F 70°C	158°F 70°C	158°F 70°C
	Relative Price	—	Low	Low	Low	Low	Low	Med

Cable Tie Catalog Page	Product Line	Cross Sections					
	PAN-TY® (B1.6 - Note 5)	✓	SM, M, I, S	LH, H, EH	✓	✓	✓
	SUPER-GRIP® (B1.38)	✓	M, I, S, LH	H	✓		
	DOME-TOP® Barb Ty (B1.43)	✓	M, I, S	LH	✓	✓	✓
	DURA-TY™ (B1.53)						
	Parallel-Entry (B1.56)	✓	M, I, S, HS	LH		✓	
	STA-STRAP® (B1.65)	✓	M, I, S, LH, H		✓		
	Specialty Ties (B1.73)	✓		H	✓		✓

Check mark indicates material availability in that product line.
 Cross Sections: SM = Subminiature, M = Miniature, I = Intermediate, S = Standard, HS = Heavy-Standard, LH = Light-Heavy, H = Heavy, EH = Extra-Heavy

*For information on re-usable Hook and Loop Cable Ties, see page B1.85.

A.
System
Overview

B1.
Cable Ties

B2.
Cable
Accessories

B3.
Stainless
Steel Ties

C1.
Wiring
Duct

C2.
Surface
Raceway

C3.
Abrasion
Protection

C4.
Cable
Management

D1.
Terminals

D2.
Power
Connectors

D3.
Grounding
Connectors

E1.
Labeling
Systems

E2.
Labels

E3.
Pre-Printed
& Write-On
Markers

E4.
Permanent
Identification

E5.
Lockout/
Tagout
& Safety
Solutions

F.
Index

Recommendation Legend	Highest	High	Acceptable	Low	Lowest
	●	◐	○	◑	●

Bundle	Bundle, Identify	Bundle	Bundle	Bundle, Re-use	Bundle	Bundle	Bundle	Bundle	Bundle
Flame Retardant Nylon 6.6	Flame Retardant Nylon 6.6	Weather Resistant Nylon 12	Polypropylene	Weather Resistant Polypropylene	TEFZEL [■]	HALAR [▲]	PEEK	Metal Detectable Nylon 6.6	Weather Resistant Acetal
Black	Natural Ivory	Black	Green	Black	Aqua Blue	Maroon	Translucent Brown	Blue	Black
60	69	120	109	100	76	702Y	71	86	N/A
11,000	11,000	6,700	4,100	4,100	7,500	7,000	15,200	—	6,500
1.1%	1.1%	0.3%	0.1%	0.1%	<0.03%	<0.05%	0.5%	1.2%	<0.45%
1 x 10 ⁵	1 x 10 ⁵	3.5 x 10 ⁶	1 x 10 ⁶	1 x 10 ⁶	2 x 10 ⁸	2 x 10 ⁸	1 x 10 ⁹	—	6 x 10 ⁵
1 – 2	1 – 2	12 – 15	1	7 – 9	>15	>15	1 – 2	—	>20
◑	◑	○	◐	◐	●	●	●	○	◐
◑	◑	◐	●	●	●	●	●	◑	○
●	●	●	○	○	●	●	●	●	●
◐	◐	◐	○	○	●	●	●	◐	◐
●	●	○	●	●	●	●	○	●	●
◐	◐	◐	●	●	●	●	●	◐	●
◑	◑	◐	●	●	●	●	◐	—	◑
212°F 100°C	212°F 100°C	194°F 90°C	239°F 115°C	239°F 115°C	338°F 170°C	302°F 150°C	500°F 260°C (Note 3)	185°F 85°C	185°F 85°C
-40°F -40°C	-76°F -60°C	-76°F -60°C	-76°F -60°C	-76°F -60°C	-76°F -60°C	-76°F -60°C	-76°F -60°C	-76°F -60°C	-76°F -60°C
V-0	V-0	HB	HB	HB	V-0	V-0	V-0	HB	HB
PASS	PASS	—	—	—	—	—	PASS	—	PASS
34	34	—	—	—	30	52	35	—	—
Yes	Yes	Yes	Yes	Yes	No	No	Yes	Yes	Yes
PASS	PASS	—	—	—	—	—	—	—	—
154°F 68°C	154°F 68°C	122°F 50°C	122°F 50°C	122°F 50°C	—	149°F 65°C	313°F 156°C	145°F 63°C	239°F 115°C
Med	Med	Med	Med	Med	High	High	High	Low	Med

✓	✓	✓	✓	✓	✓	✓	✓	✓	✓
	✓								
	✓								✓

Note 1: Also known as Relative Thermal Index (RTI), see Temperature (page B1.101)

Note 2: Estimated
Note 3: Based on the UL RTI for electrical properties

Note 4: See Table B (page B1.100)
Note 5: Also available in 00 material (meets Mil Spec)

■ TEFZEL is a registered trademark of E.I. du Pont de Nemours and Company.

▲ HALAR is a registered trademark of Solvay Solexis, Inc.

A.
System
Overview

Cable Tie Styles Overview

B1.
Cable Ties

PAN-TY® Cable Ties

Pages B1.6 – B1.37

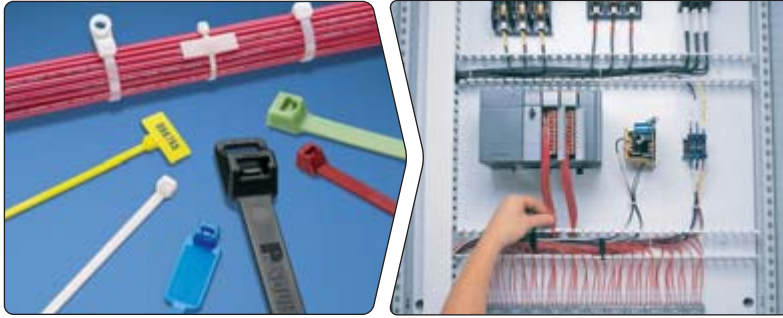

- Designed for use in numerous applications to meet a variety of needs in the OEM, MRO, and construction markets
- Largest selection of styles, materials, and sizes
- One-piece construction for consistent performance and reliability
- Lowest threading force of any one-piece cable tie in the industry

C1.
Wiring
Duct

C2.
Surface
Raceway

SUPER-GRIP® Cable Ties

Pages B1.38 – B1.42



- Designed for the strength requirements of the MRO and construction markets
- Thin, wide strap body – flexible, conforms to bundles
- Strong – withstands rough installation practices
- Grips wires tightly and resists lateral movement

C3.
Abrasion
Protection

C4.
Cable
Management

D1.
Terminals

DOME-TOP® Barb Ty Cable Ties

Pages B1.43 – B1.55



- Approved for the demanding MRO and construction requirements as typified in the oil and gas markets
- Stainless steel barb provides consistent performance and reliability
- Infinitely adjustable for tight bundles throughout entire bundle range
- Dome-top head features unique patented design with smooth, round edges

D2.
Power
Connectors

D3.
Grounding
Connectors

E1.
Labeling
Systems

E2.
Labels

Parallel-Entry Cable Ties

Pages B1.56 – B1.64



- Designed for use in the OEM and transportation markets
- All parallel-entry ties provide a low profile head which avoids snags and reduces overall bundle size
- No protrusion of tie cut-off – protects workers' arms/hands
- *CONTOUR-TY*® Cable Ties have outside teeth and smooth, round edges to protect cable jacket – perfect for high vibration applications

E3.
Pre-Printed
& Write-On
Markers

E4.
Permanent
Identification

E5.
Lockout/
Tagout
& Safety
Solutions

F.
Index

STA-STRAP® Cable Ties

Pages B1.65 – B1.72



- Convenient and easy to use in OEM manual assembly operations
- Exclusive, two-piece design provides lowest threading force in the industry
- Use for normal bundling and through-panel applications
- Releasable prior to final tensioning and cut-off

Hook and Loop Cable Ties

Pages B1.85 – B1.90



- Ideal for the telecommunications, financial, education and government markets
- Adjustable, releasable, and re-usable
- No risk of over-tensioning or damaging high performance network cables
- Variety of styles, sizes, and colors

Manual Cable Tie Installation Tools

Pages B1.107 – B1.112



- Used in production, maintenance, and construction applications
- Designed for ease of use and to reduce repetitive stress injuries
- Full line of lightweight, ergonomic hand tools – PANDUIT leads the industry in reliability and performance
- Flush cut-off of cable tie limits exposure to sharp edges

Automatic Cable Tie Installation Tools

Pages B1.113 – B1.121



- An efficient solution for high volume OEM harness, assembly, fastening and packaging applications
- High-speed tools lower installed cost and reduce operator fatigue
- Wrap, tension, and cut-off cable ties in less than a second
- Reel-fed systems for miniature and standard cross section cable ties

A. System Overview

B1. Cable Ties

B2. Cable Accessories

B3. Stainless Steel Ties

C1. Wiring Duct

C2. Surface Raceway

C3. Abrasion Protection

C4. Cable Management

D1. Terminals

D2. Power Connectors

D3. Grounding Connectors

E1. Labeling Systems

E2. Labels

E3. Pre-Printed & Write-On Markers

E4. Permanent Identification

E5. Lockout/Tagout & Safety Solutions

F. Index

A.
System
Overview

Features and Benefits – PAN-TY® Cable Ties

B1.
Cable Ties

One-piece design for consistent performance and reliability.
Available in lengths from 2.8 to 43.3 inches and a variety of styles, materials, and colors for specific applications.

B2.
Cable
Accessories

B3.
Stainless
Steel Ties

C1.
Wiring
Duct

C2.
Surface
Raceway

C3.
Abrasion
Protection

C4.
Cable
Management

D1.
Terminals

D2.
Power
Connectors

D3.
Grounding
Connectors

E1.
Labeling
Systems

E2.
Labels

E3.
Pre-Printed
& Write-On
Markers

E4.
Permanent
Identification

E5.
Lockout/
Tagout/
& Safety
Solutions

F.
Index

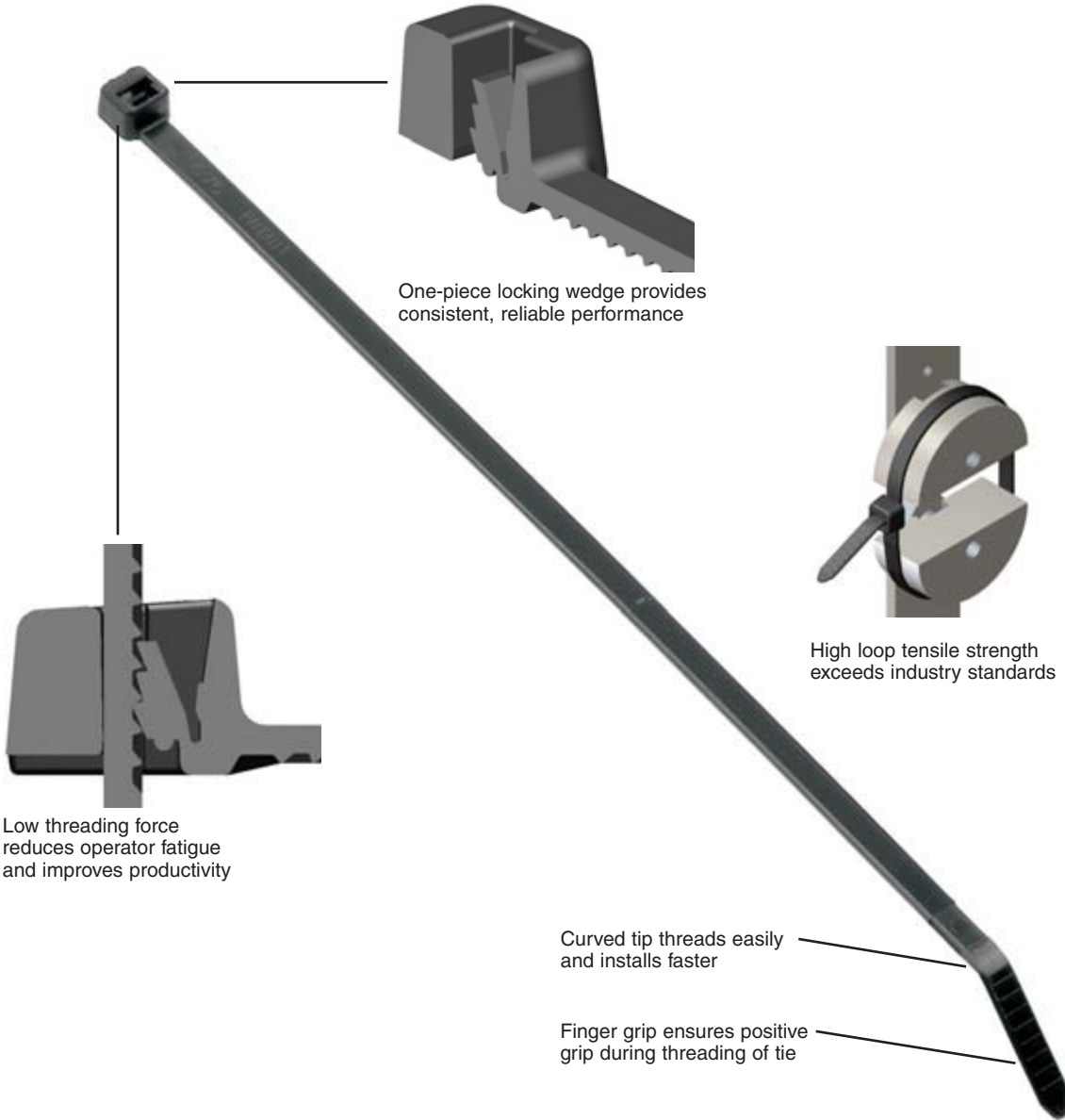

Cable tie tools speed installation and reduce total installed cost.
See pages B1.107 – B1.112.



Cable tie accessories are used to speed and simplify the mounting of wires, cables, and tubing.
See pages B2.1 – B2.29.

Selection Guide – PAN-TY® Cable Ties



Material, Color (Suffix)	Style/Function	Part Number Prefix	Catalog Page
Nylon 6.6, Natural (No Suffix)	Locking Ties/Bundle	PLT	B1.8,9
	Releasable Ties/Re-usable	PRT	B1.22
	Clamp Ties/Mount	PLC	B1.26
	Push Mount Ties/Mount	PLWP, PRWP, PLUP, PLP	B1.28,30,32,33
	Marker Ties/Identify	PLF, PLM	B1.34
Weather Resistant Nylon 6.6, Black (0)	Locking Ties/Bundle	PLT	B1.10,11
	Releasable Ties/Re-usable	PRT	B1.23,24
	Clamp Ties/Mount	PLC	B1.27
	Push Mount Ties/Mount	PLWP, PRWP, PLUP, PLP	B1.29,30,31,33
	Marker Ties/Identify	PLF, PLM	B1.34
Heat Stabilized Nylon 6.6, Black (30)	Locking Ties/Bundle	PLT	B1.12
	Releasable Ties/Re-usable	PRT	B1.23
	Clamp Ties/Mount	PLC	B1.27
	Push Mount Ties/Mount	PLWP, PRLWP, PRWP, PLUP, PLP	B1.29 – B1.33
Heat Stabilized Weather Resistant Nylon 6.6, Black (300)	Locking Ties/Bundle	PLT	B1.13
Heat Stabilized Nylon 6.6, Natural (39)	Locking Ties/Bundle	PLT	B1.12
Flame Retardant Nylon 6.6, Black (60)	Locking Ties/Bundle	PLT	B1.14
	Locking Ties/Bundle	PLT	B1.14
Flame Retardant Nylon 6.6, Ivory (69)	Locking Ties/Bundle	PLT	B1.14
	Marker Ties/Identify	PLF, PLM	B1.34
Weather Resistant Nylon 12, Black (120)	Locking Ties/Bundle	PLT	B1.15
Polypropylene, Green (109)	Locking Ties/Bundle	PLT	B1.16
Weather Resistant Polypropylene, Black (100)	Locking Ties/Bundle	PLT	B1.17
	Releasable Ties/Re-usable	PRT	B1.25
HALAR [▲] , Maroon (702) TEFZEL [■] , Aqua Blue (76)	Locking Ties/Bundle	PLT	B1.18,19
	Locking Ties/Bundle	PLT	B1.18,19
PEEK, Translucent Brown (71)	Locking Ties/Bundle	PLT	B1.20
Metal Detectable, Blue (86)	Locking Ties/Bundle	PLT	B1.21

▲HALAR is a registered trademark of Solvay Solexis, Inc. ■TEFZEL is a registered trademark of E.I. du Pont de Nemours and Company.

Part Number System for PAN-TY® Cable Ties

PLT	2	S	—	C	—
Type	Size	Cross Section	Screw Hole Size	Package Size	Material/Color
PLT = Locking Tie	Approx.	SM = Subminiature	(Clamp Ties Only)	Q = 25	See Page B1.35
PRT = Releasable Tie	Maximum	M = Miniature	-S4 = #4 (M2.5)	L = 50	
PLC = Locking Clamp	Bundle	I = Intermediate	-S6 = #6 (M3)	C = 100	
PLF = Locking Flag	Dia. (In.)	S = Standard	-S8 = #8 (M4)	TL = 250	
PLM = Locking Marker		LH = Light-Heavy	-S10 = #10 (M5)	D = 500	
PLP = Locking Push Mount		H = Heavy	-S25 = 1/4 (M6)	M = 1000	
PLWP = Locking Wing Push Mount		EH = Extra-Heavy		VMR = 2 reels/2500 ea.	
PRLWP = Releasable Ladder Wing Push Mount				XMR = 2 reels/5000 ea.	
PRWP = Releasable Wing Push Mount					
PLUP = Locking Umbrella Push Mount					

A. System Overview

UL US **UL LISTED** **CSA US** **PAN-Ty® Cable Ties – Nylon 6.6**

B1. Cable Ties

- For indoor use
- Versatile cable ties can be used in countless applications
- One-piece construction for consistent performance and reliability

- Lowest threading force of any one-piece cable tie in the industry
- Curved tip is easy to pick up from flat surfaces and allows faster initial threading to speed installation
- A variety of materials and colors are available for specific applications

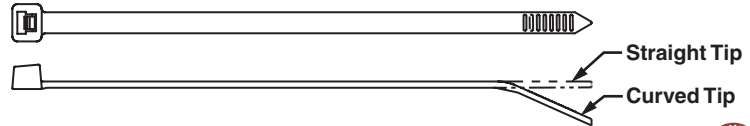
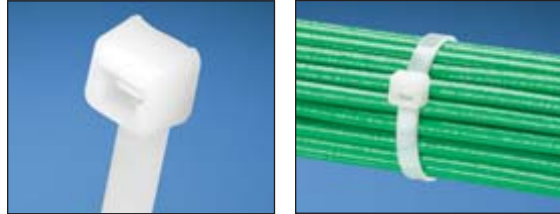

C1. Wiring Duct

Part Number	Length		Width		Thickness		Max. Bundle Dia.		Min. Loop Tensile Str.		Recommended Installation Tool	Std. Pkg. Qty.	Std. Ctn. Qty.
	In.	mm	In.	mm	In.	mm	In.	mm	Lbs.	N			

C2. Surface Raceway

Subminiature Cross Section													
PLT.6SM-C	2.8	71	.070	1.8	.030	.8	.60	15	8	36	GTS, GTSL, PTS	100	1000

C3. Abrasion Protection

Miniature Cross Section													
PLT.7M-C	3.1	79	.090	2.3	.032	.8	.68	17	18	80	GTS, GTSL, GS2B, PTS, PPTS, STS2	100	1000
PLT1M-C	3.9	99	.098	2.5	.043	1.1	.87	22	18	80		100	1000
PLT1.5M-C	5.6	142	.098	2.5	.043	1.1	1.25	32	18	80		100	1000
PLT2M-C	8.0	203	.098	2.5	.043	1.1	2.00	51	18	80		100	1000

C4. Cable Management

Intermediate Cross Section													
PLT1.5I-C	5.6	142	.142	3.6	.045	1.1	1.38	35	40	178	GTS, GTSL, GS2B, PTS, PPTS, STS2	100	1000
PLT2I-C	8.0	203	.142	3.6	.045	1.1	2.00	51	40	178		100	1000
PLT2.5I-C	9.7	246	.145	3.7	.052	1.3	2.50	64	40	178		100	1000
PLT3I-C	11.4	290	.145	3.7	.052	1.3	3.00	76	40	178		100	1000
PLT4I-C	14.5	368	.145	3.7	.052	1.3	4.00	102	40	178		100	1000

D1. Terminals

Standard Cross Section													
PLT1S-C	4.8	122	.190	4.8	.052	1.3	1.00	25	50	222	GTS, GTSL, GS2B, GTH, GS4H, PTS, PPTS, PTH, STS2, STH2	100	1000
PLT1.5S-C	6.2	157	.190	4.8	.052	1.3	1.50	38	50	222		100	1000
PLT2S-C	7.4	188	.190	4.8	.052	1.3	1.88	48	50	222		100	1000
PLT2.5S-C	9.8	249	.190	4.8	.052	1.3	2.50	64	50	222		100	1000
PLT3S-C	11.5	292	.190	4.8	.052	1.3	3.00	76	50	222		100	1000
PLT4S-C	14.5	368	.190	4.8	.052	1.3	4.00	102	50	222		100	1000
PLT4.5S-C	15.5	394	.190	4.8	.052	1.3	4.50	114	50	222		100	1000
PLT5S-C	17.5	445	.190	4.8	.052	1.3	5.00	127	50	222		100	500

D2. Power Connectors

D3. Grounding Connectors

E1. Labeling Systems

Light-Heavy Cross Section (Straight Tip)													
PLT2H-L	8.1	206	.300	7.6	.075	1.9	2.00	51	120	534	GTH, GS4H, GS4EH, PTH, STH2, ST3EH	50	500
PLT2.5H-L	9.8	251	.300	7.6	.075	1.9	2.50	64	120	534		50	500
PLT3H-L	11.4	290	.300	7.6	.075	1.9	3.00	76	120	534		50	500
PLT4H-L	14.5	368	.300	7.6	.075	1.9	4.00	102	120	534		50	500
PLT6LH-L	21.9	556	.300	7.6	.075	1.9	6.00	152	120	534		50	500
PLT7LH-L	24.7	627	.300	7.6	.075	1.9	7.00	178	120	534		50	500
PLT8LH-L	27.6	701	.300	7.6	.075	1.9	8.00	203	120	534		50	500
PLT9LH-L*	30.5	775	.300	7.6	.075	1.9	9.00	229	120	534		50	500
PLT10LH-L*	34.3	871	.300	7.6	.075	1.9	10.31	262	120	534		50	1000

E2. Labels

E3. Pre-Printed & Write-On Markers

E4. Permanent Identification

Heavy Cross Section (Straight Tip)													
PLT5H-L*	17.7	450	.350	8.9	.078	2.0	5.00	127	175	778	GTH, GS4H, GS4EH, PTH, STH2, ST3EH	50	500
PLT6H-L*	20.9	530	.350	8.9	.078	2.0	6.00	152	175	778		50	500
PLT8H-L*	30.6	779	.350	8.9	.078	2.0	9.00	229	175	778		50	500
PLT13H-Q*	43.3	1100	.350	8.9	.078	2.0	13.00	330	175	778		25	500

E5. Lockout/Tagout & Safety Solutions

*UL Listed – meets the requirements of UL 181B-C, for use with UL non-metallic air ducts and air connectors.
Note: UL Listed for use in plenum or air handling spaces per NEC except PLT.6SM and PLT5H/6H/8H/13H.

F. Index

PAN-TY® Lashing Ties – Nylon 6.6

- For indoor use
- Typically used for heavy duty applications
- Strongest PAN-TY® Cable Tie available
- Can be used with MCEH mounting clip, see page B1.24

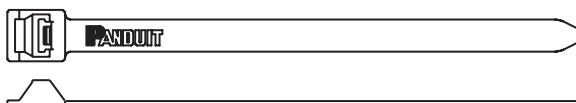

Part Number	Length		Width		Thickness		Max. Bundle Dia.		Min. Loop Tensile Str.		Recommended Installation Tool	Std. Pkg. Qty.	Std. Ctn. Qty.
	In.	mm	In.	mm	In.	mm	In.	mm	Lbs.	N			
Extra-Heavy Cross Section													
PLT2EH-C	9.0	229	.500	12.7	.075	1.9	2.00	51	250	1112	GS4EH, ST3EH	100	1000
PLT5EH-Q	20.1	511	.500	12.7	.075	1.9	5.00	127	250	1112		25	250
PLT6EH-Q	22.2	564	.500	12.7	.075	1.9	6.00	152	250	1112		25	250
PLT8EH-C	28.3	719	.500	12.7	.085	2.2	8.00	203	250	1112		100	1000
PLT10EH-C	34.2	869	.500	12.7	.085	2.2	10.00	254	250	1112		100	500
PLT12EH-C	40.1	1019	.500	12.7	.085	2.2	12.00	305	250	1112		100	500

A. System Overview

B1. Cable Ties

B2. Cable Accessories

B3. Stainless Steel Ties

C1. Wiring Duct

C2. Surface Raceway

C3. Abrasion Protection

C4. Cable Management

D1. Terminals

D2. Power Connectors

D3. Grounding Connectors

E1. Labeling Systems

E2. Labels

E3. Pre-Printed & Write-On Markers

E4. Permanent Identification

E5. Lockout/Tagout & Safety Solutions

F. Index

A. System Overview

UL **UL** **SP** **PAN-TY® Cable Ties – Weather Resistant Nylon 6.6**

B1. Cable Ties

- Greater resistance to damage caused by ultraviolet light – indoor or outdoor use
- Versatile cable ties can be used in countless applications
- One-piece construction for consistent performance and reliability
- Lowest threading force of any one-piece cable tie in the industry
- Curved tip is easy to pick up from flat surfaces and allows faster initial threading to speed installation

B2. Cable Accessories

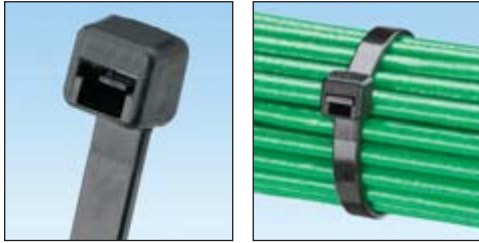

B3. Stainless Steel Ties

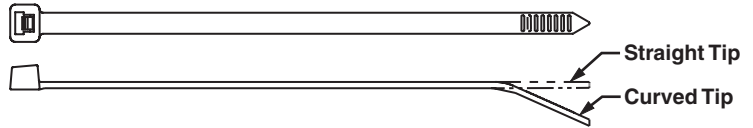

C1. Wiring Duct

C2. Surface Raceway

Part Number	Length		Width		Thickness		Max. Bundle Dia.		Min. Loop Tensile Str.		Recommended Installation Tool	Std. Pkg. Qty.	Std. Ctn. Qty.
	In.	mm	In.	mm	In.	mm	In.	mm	Lbs.	N			

C3. Abrasion Protection

Subminiature Cross Section

PLT.6SM-C0	2.8	71	.070	1.8	.030	.8	.60	15	8	36	GTS, GTSL, PTS	100	1000
-------------------	-----	----	------	-----	------	----	-----	----	---	----	----------------	-----	------

Miniature Cross Section

PLT.7M-M0	3.1	79	.090	2.3	.032	.8	.68	17	18	80	GTS, GTSL, GS2B, PTS, PPTS, STS2	1000	50000
PLT1M-C0	3.9	99	.098	2.5	.043	1.1	.87	22	18	80		100	1000
PLT1.5M-C0	5.6	142	.098	2.5	.043	1.1	1.25	32	18	80		100	1000
PLT2M-C0	8.0	203	.098	2.5	.043	1.1	2.00	51	18	80		100	1000

C4. Cable Management

Intermediate Cross Section

PLT1.5I-C0	5.6	142	.142	3.6	.045	1.1	1.38	35	40	178	GTS, GTSL, GS2B, PTS, PPTS, STS2	100	1000
PLT2I-C0	8.0	203	.142	3.6	.045	1.1	2.00	51	40	178		100	1000
PLT2.5I-C0	9.7	246	.145	3.7	.052	1.3	2.50	64	40	178		100	1000
PLT3I-C0	11.4	290	.145	3.7	.052	1.3	3.00	76	40	178		100	1000
PLT4I-C0	14.5	368	.145	3.7	.052	1.3	4.00	102	40	178		100	1000

D1. Terminals

D2. Power Connectors

Standard Cross Section

PLT1S-C0	4.8	122	.190	4.8	.052	1.3	1.00	25	50	222	GTS, GTSL, GS2B, GTH, GS4H, PTS, PTH, PPTS, STS2, STH2	100	1000
PLT1.5S-C0	6.2	157	.190	4.8	.052	1.3	1.50	38	50	222		100	1000
PLT2S-C0	7.4	188	.190	4.8	.052	1.3	1.88	48	50	222		100	1000
PLT2.5S-C0	9.8	249	.190	4.8	.052	1.3	2.50	64	50	222		100	1000
PLT3S-C0	11.5	292	.190	4.8	.052	1.3	3.00	76	50	222		100	1000
PLT4S-C0	14.5	368	.190	4.8	.052	1.3	4.00	102	50	222		100	1000
PLT4.5S-C0	15.5	394	.190	4.8	.052	1.3	4.50	114	50	222		100	1000
PLT5S-C0	17.5	445	.190	4.8	.052	1.3	5.00	127	50	222		100	500

D3. Grounding Connectors

E1. Labeling Systems

Light-Heavy Cross Section (Straight Tip)

PLT2H-L0	8.1	206	.300	7.6	.075	1.9	2.00	51	120	534	GTH, GS4H, GS4EH, PTH, STH2, ST3EH	50	500
PLT2.5H-L0	9.8	251	.300	7.6	.075	1.9	2.50	64	120	534		50	500
PLT3H-L0	11.4	290	.300	7.6	.075	1.9	3.00	76	120	534		50	500
PLT4H-L0	14.5	368	.300	7.6	.075	1.9	4.00	102	120	534		50	500
PLT6LH-L0	21.9	556	.300	7.6	.075	1.9	6.00	152	120	534		50	500
PLT7LH-L0	24.7	627	.300	7.6	.075	1.9	7.00	178	120	534		50	500
PLT8LH-L0	27.6	701	.300	7.6	.075	1.9	8.00	203	120	534		50	500
PLT9LH-L0	30.5	775	.300	7.6	.075	1.9	9.00	229	120	534		50	500

E3. Pre-Printed & Write-On Markers

E4. Permanent Identification

Heavy Cross Section (Straight Tip)

PLT5H-L0	17.7	450	.350	8.9	.078	2.0	5.00	127	175	778	GTH, GS4H, GS4EH, PTH, STH2, ST3EH	50	500
PLT6H-L0	20.9	530	.350	8.9	.078	2.0	6.00	152	175	778		50	500
PLT8H-L0	30.6	779	.350	8.9	.078	2.0	9.00	229	175	778		50	500
PLT13H-Q0	43.3	1100	.350	8.9	.078	2.0	13.00	330	175	778		25	500

E5. Lockout/Tagout & Safety Solutions

F. Index

Note: UL Listed and UL Recognized except PLT.6SM and PLT2H/2.5H/3H/4H/5H/6H/8H/13H; CSA Certified except LH and H cross sections.

PAN-TY® Lashing Ties – Weather Resistant Nylon 6.6

- Greater resistance to damage caused by ultraviolet light – indoor or outdoor use
- Typically used for heavy duty applications
- Strongest PAN-TY® Cable Tie available
- Can be used with MCEH mounting clip, see page B1.24



Lashing Tie

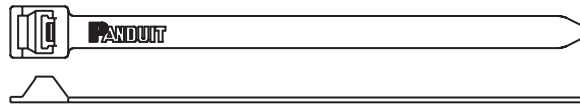

No Buckle Design

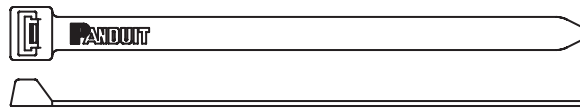

Part Number	Length		Width		Thickness		Max. Bundle Dia.		Min. Loop Tensile Str.		Recommended Installation Tool	Std. Pkg. Qty.	Std. Ctn. Qty.
	In.	mm	In.	mm	In.	mm	In.	mm	Lbs.	N			
Extra-Heavy Cross Section													
PLT2EH-Q0	9.0	229	.500	12.7	.075	1.9	2.00	51	250	1112	GS4EH, ST3EH	25	250
PLT5EH-Q0	20.1	511	.500	12.7	.075	1.9	5.00	127	250	1112		25	250
PLT6EH-Q0	22.2	564	.500	12.7	.075	1.9	6.00	152	250	1112		25	250
PLT8EH-Q0	28.3	719	.500	12.7	.085	2.2	8.00	203	250	1112		25	250
PLT10EH-Q0	34.2	869	.500	12.7	.085	2.2	10.00	254	250	1112		25	250
PLT12EH-Q0	40.1	1019	.500	12.7	.085	2.2	12.00	305	250	1112		25	250
Extra-Heavy Cross Section (No Buckle Design)													
PLT3EH-NB-C0	12.2	310	.500	12.7	.075	1.9	3.30	84	250	1112	GS4EH, ST3EH	100	1000
PLT5EH-NB-C0	19.8	503	.500	12.7	.075	1.9	5.00	127	250	1112		100	1000
PLT6EH-NB-C0	21.8	554	.500	12.7	.075	1.9	6.00	152	250	1112		100	1000

A. System Overview

B1. Cable Ties

B2. Cable Accessories

B3. Stainless Steel Ties

C1. Wiring Duct

C2. Surface Raceway

C3. Abrasion Protection

C4. Cable Management

D1. Terminals

D2. Power Connectors

D3. Grounding Connectors

E1. Labeling Systems

E2. Labels

E3. Pre-Printed & Write-On Markers

E4. Permanent Identification

E5. Lockout/Tagout & Safety Solutions

F. Index

A. System Overview

B1. Cable Ties

B2. Cable Accessories

B3. Stainless Steel Ties

C1. Wiring Duct

C2. Surface Raceway

C3. Abrasion Protection

C4. Cable Management

D1. Terminals

D2. Power Connectors

D3. Grounding Connectors

E1. Labeling Systems

E2. Labels

E3. Pre-Printed & Write-On Markers

E4. Permanent Identification

E5. Lockout/Tagout & Safety Solutions

F. Index

cUL[®] US cUL[®] LISTED cSF[®] US PAN-TY[®] Cable Ties – Heat Stabilized Nylon 6.6

- For high temperature applications up to 239°F (115°C) – indoor use
- One-piece construction for consistent performance and reliability
- Lowest threading force of any one-piece cable tie in the industry
- Curved tip is easy to pick up from flat surfaces and allows faster initial threading to speed installation

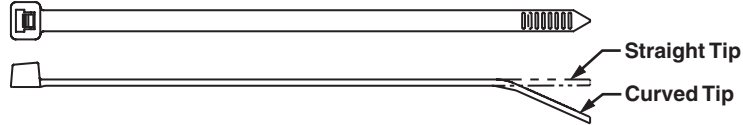

Part Number	Length		Width		Thickness		Max. Bundle Dia.		Min. Loop Tensile Str.		Recommended Installation Tool	Std. Pkg. Qty.	Std. Ctn. Qty.	
	In.	mm	In.	mm	In.	mm	In.	mm	Lbs.	N				
Subminiature Cross Section														
PLT.6SM-M30	2.8	71	.070	1.8	.030	.8	.60	15	8	36	GTS, GTSL, PTS	1000	50000	
Miniature Cross Section														
PLT.7M-M30	3.1	79	.090	2.3	.032	.8	.68	17	18	80	GTS, GTSL, GS2B, PTS, PPTS, STS2	1000	50000	
PLT1M-C30	3.9	99	.098	2.5	.043	1.1	.87	22	18	80		100	1000	
PLT1.5M-M30	5.6	142	.098	2.5	.043	1.1	1.25	32	18	80		1000	50000	
PLT2M-M30	8.0	203	.098	2.5	.043	1.1	2.00	51	18	80		1000	25000	
Intermediate Cross Section														
PLT1.5I-C30	5.6	142	.142	3.6	.045	1.1	1.38	35	40	178	GTS, GTSL, GS2B, PTS, PPTS, STS2	100	1000	
PLT2I-C30	8.0	203	.142	3.6	.045	1.1	2.00	51	40	178		100	1000	
PLT3I-M30	11.4	290	.145	3.7	.052	1.3	3.00	76	40	178		1000	10000	
PLT4I-M30	14.5	368	.145	3.7	.052	1.3	4.00	102	40	178		1000	10000	
Standard Cross Section														
PLT1S-M30	4.8	122	.190	4.8	.052	1.3	1.00	25	50	222	GTS, GTSL, GS2B, GTH, GS4H, PTS, PTH, PPTS, STS2, STH2	1000	10000	
PLT1.5S-M30	6.2	157	.190	4.8	.052	1.3	1.50	38	50	222		1000	10000	
PLT2S-C30	7.4	188	.190	4.8	.052	1.3	1.88	48	50	222		100	1000	
PLT2S-M39*	7.4	188	.190	4.8	.052	1.3	1.88	48	50	222		1000	10000	
PLT2.5S-M30	9.8	249	.190	4.8	.052	1.3	2.50	64	50	222		1000	10000	
PLT3S-C30	11.5	292	.190	4.8	.052	1.3	3.00	76	50	222		100	1000	
PLT4S-C30	14.5	368	.190	4.8	.052	1.3	4.00	102	50	222		100	1000	
PLT5S-M30	17.5	445	.190	4.8	.052	1.3	5.00	127	50	222		1000	5000	
Light-Heavy Cross Section (Straight Tip)														
PLT2H-TL30	8.1	206	.300	7.6	.075	1.9	2.00	51	120	534		GTH, GS4H, GS4EH, PTH, STH2, ST3EH	250	2500
PLT3H-TL30	11.4	290	.300	7.6	.075	1.9	3.00	76	120	534	250		2500	
PLT4H-TL30	14.5	368	.300	7.6	.075	1.9	4.00	102	120	534	250		2500	
PLT7LH-C30	24.7	627	.300	7.6	.075	1.9	7.00	178	120	534	100		2000	
PLT9LH-C30	30.5	775	.300	7.6	.075	1.9	9.00	229	120	534	100		1000	
Heavy Cross Section (Straight Tip)														
PLT5H-C30	17.7	450	.350	8.9	.078	2.0	5.00	127	175	778	GTH, GS4H, GS4EH, PTH, STH2, ST3EH	100	2000	
PLT6H-C30	20.9	530	.350	8.9	.078	2.0	6.00	152	175	778		100	2000	
PLT8H-C30	30.6	779	.350	8.9	.078	2.0	9.00	229	175	778		100	1500	

*Natural heat stabilized material (39).
Note: UL Listed except PLT.6SM and PLT5H/6H/8H.



PAN-TY® Cable Ties – Heat Stabilized Weather Resistant Nylon 6.6

- Greater resistance to damage caused by ultraviolet light and for high temperature applications up to 212°F (100°C) – indoor or outdoor use
- One-piece construction for consistent performance and reliability

- Lowest threading force of any one-piece cable tie in the industry
- Curved tip is easy to pick up from flat surfaces and allows faster initial threading to speed installation

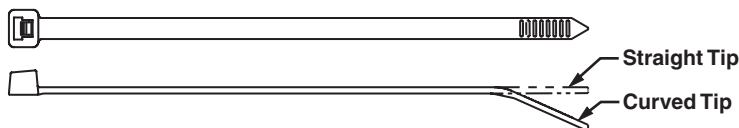

Part Number	Length		Width		Thickness		Max. Bundle Dia.		Min. Loop Tensile Str.		Recommended Installation Tool	Std. Pkg. Qty.	Std. Ctn. Qty.
	In.	mm	In.	mm	In.	mm	In.	mm	Lbs.	N			
Miniature Cross Section													
PLT1M-M300	3.9	99	.098	2.5	.035	.9	.87	22	18	80	GTS, GTSL, GS2B, PTS, PPTS, STS2	1000	50000
Intermediate Cross Section													
PLT1.5I-M300	5.6	142	.142	3.6	.045	1.1	1.38	35	40	178	GTS, GTSL, GS2B, PTS, PPTS, STS2	1000	25000
PLT2I-M300	8.0	203	.142	3.6	.045	1.1	2.00	51	40	178		1000	25000
Standard Cross Section													
PLT1S-M300	4.8	122	.190	4.8	.052	1.3	1.00	25	50	222	GTS, GTSL, GS2B, GTH, GS4H, PTS, PTH, PPTS, STS2, STH2	1000	10000
PLT2S-M300	7.4	188	.190	4.8	.052	1.3	1.88	48	50	222		1000	10000
PLT4S-M300	14.5	368	.190	4.8	.052	1.3	4.00	102	50	222		1000	5000
Light-Heavy Cross Section (Straight Tip)													
PLT2H-TL300	8.4	213	.300	7.6	.075	1.9	2.00	51	120	534	GTH, GS4H, GS4EH, PTH, STH2, ST3EH	250	2500
PLT4H-TL300	14.5	368	.300	7.6	.075	1.9	4.00	102	120	534		250	2500

A. System Overview

B1. Cable Ties

B2. Cable Accessories

B3. Stainless Steel Ties

C1. Wiring Duct

C2. Surface Raceway

C3. Abrasion Protection

C4. Cable Management

D1. Terminals

D2. Power Connectors

D3. Grounding Connectors

E1. Labeling Systems

E2. Labels

E3. Pre-Printed & Write-On Markers

E4. Permanent Identification

E5. Lockout/Tagout & Safety Solutions

F. Index

A. System Overview

B1. Cable Ties

B2. Cable Accessories

B3. Stainless Steel Ties

C1. Wiring Duct

C2. Surface Raceway

C3. Abrasion Protection

C4. Cable Management

D1. Terminals

D2. Power Connectors

D3. Grounding Connectors

E1. Labeling Systems

E2. Labels

E3. Pre-Printed & Write-On Markers

E4. Permanent Identification

E5. Lockout/Tagout & Safety Solutions

F. Index

UL US C US PAN-TY® Cable Ties – Flame Retardant Nylon 6.6

- Flammability rating of UL 94V-0 – indoor use
- One-piece construction for consistent performance and reliability
- Lowest threading force of any one-piece cable tie in the industry
- Curved tip is easy to pick up from flat surfaces and allows faster initial threading to speed installation

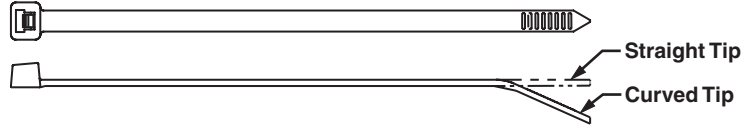

Part Number	Length		Width		Thickness		Max. Bundle Dia.		Min. Loop Tensile Str.		Recommended Installation Tool	Std. Pkg. Qty.	Std. Ctn. Qty.
	In.	mm	In.	mm	In.	mm	In.	mm	Lbs.	N			
Miniature Cross Section													
PLT1M-M60*	4.0	102	.098	2.5	.043	1.1	.87	22	18	80	GTS, GTSL, GS2B, PTS, PPTS, STS2	1000	25000
PLT1M-M69	4.0	102	.098	2.5	.043	1.1	.87	22	18	80		1000	25000
PLT2M-M69	8.0	203	.098	2.5	.043	1.1	2.00	51	18	80		1000	25000
Intermediate Cross Section													
PLT1.5I-M69	5.6	142	.142	3.6	.044	1.1	1.38	35	40	178	GTS, GTSL, GS2B, PTS, PPTS, STS2	1000	25000
PLT2I-M69	8.0	203	.142	3.6	.044	1.1	2.00	51	40	178		1000	25000
Standard Cross Section													
PLT2S-M60*	7.4	188	.190	4.8	.052	1.3	1.88	48	50	222	GTS, GTSL, GS2B, GTH, GS4H, PTS, PTH, PPTS, STS2, STH2	1000	10000
PLT2S-M69	7.4	188	.190	4.8	.052	1.3	1.88	48	50	222		1000	10000
PLT4S-M69	14.5	368	.190	4.8	.052	1.3	4.00	102	50	222		1000	5000
Light-Heavy Cross Section (Straight Tip)													
PLT4H-TL69	14.6	371	.300	7.6	.075	1.9	4.00	102	120	534	GTH, GS4H, GS4EH, PTH, STH2, ST3EH	250	2500

*Black flame retardant material (60).
Note: UL Recognized and CSA Certified except 60 material.

Cable Tie Mounts – Flame Retardant Nylon 6.6

- Flammability rating of UL 94V-0 – indoor use
- Unique cradle design provides maximum stability for the cable bundle
- Low profile design keeps bundle close to mounting surface

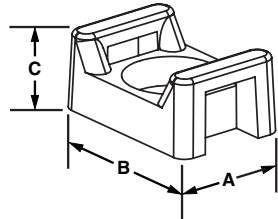

Part Number	Used With Cable Ties*	Length B		Width A		Height C		Counterbore Diameter		Mounting Method	Std. Pkg. Qty.	Std. Ctn. Qty.
		In.	mm	In.	mm	In.	mm	In.	mm			
TM1S4-M69	M	.51	13.0	.32	8.0	.23	5.8	.23	5.7	#4 (M2.5) screw	1000	5000
TM1S6-M69		.51	13.0	.32	8.0	.23	5.8	.28	7.0	#6 (M3) screw	1000	5000
TM2S6-M69	M, I, S	.63	16.0	.43	10.8	.28	7.0	.29	7.1	#6 (M3) screw	1000	5000
TM2S8-M69		.63	16.0	.43	10.8	.28	7.0	.33	8.4	#8 (M4) screw	1000	5000
TM3S8-C69	M, I, S, LH	.86	21.8	.62	15.5	.38	9.5	.32	8.1	#8 (M4) screw	100	500
TM3S10-M69		.86	21.8	.62	15.8	.38	9.5	.38	9.7	#10 (M5) screw	1000	5000

*Cable tie cross section sizes: M = Miniature, I = Intermediate, S = Standard and LH = Light-Heavy.

PAN-TY® Cable Ties – Weather Resistant Nylon 12

- For high moisture, corrosive (zinc chloride and dilute acids), and low temperature indoor or outdoor applications
- Cable tie of choice for making attachments to galvanized surfaces
- One-piece construction for consistent performance and reliability
- Lowest threading force of any one-piece cable tie in the industry
- Curved tip is easy to pick up from flat surfaces and allows faster initial threading to speed installation

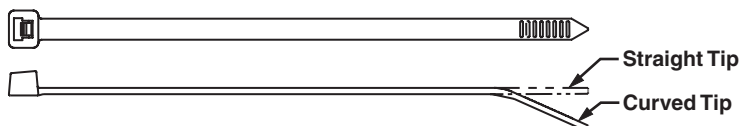

Part Number	Length		Width		Thickness		Max. Bundle Dia.		Min. Loop Tensile Str.		Recommended Installation Tool	Std. Pkg. Qty.	Std. Ctn. Qty.
	In.	mm	In.	mm	In.	mm	In.	mm	Lbs.	N			
Intermediate Cross Section													
PLT1.5I-M120	5.6	142	.142	3.6	.045	1.1	1.38	35	25	111	GTS, GTSL, GS2B, PTS, PPTS, STS2	1000	25000
Standard Cross Section													
PLT2S-M120	7.4	188	.190	4.8	.052	1.3	1.88	48	40	178	GTS, GTSL, GS2B, GTH, GS4H, PTS, PTH, PPTS, STS2, STH2	1000	10000
PLT4S-M120	14.5	368	.190	4.8	.052	1.3	4.00	102	40	178		1000	5000
Light-Heavy Cross Section (Straight Tip)													
PLT4H-TL120	14.5	368	.300	7.6	.075	1.9	4.00	102	90	400	GTH, GTSL, GS4H, GS4EH, PTH, STH2, ST3EH	250	2500
PLT8LH-C120	27.6	701	.300	7.6	.075	1.9	8.00	203	90	400		100	2000

A. System Overview

B1. Cable Ties

B2. Cable Accessories

B3. Stainless Steel Ties

C1. Wiring Duct

C2. Surface Raceway

C3. Abrasion Protection

C4. Cable Management

D1. Terminals

D2. Power Connectors

D3. Grounding Connectors

E1. Labeling Systems

E2. Labels

E3. Pre-Printed & Write-On Markers

E4. Permanent Identification

E5. Lockout/Tagout & Safety Solutions

F. Index

A.
System
Overview

PAN-TY® Cable Ties – Polypropylene – Distinctive Green Color

B1.
Cable Ties

- For chemical resistance where high loop tensile strength is not required especially in the presence of hydrochloric acid, salts, and bases
- For indoor use
- Material requires lowering the tool setting (see table below)
- One-piece construction for consistent performance and reliability
- Lowest threading force of any one-piece cable tie in the industry
- Curved tip is easy to pick up from flat surfaces and allows faster initial threading to speed installation

B2.
Cable
Accessories



B3.
Stainless
Steel Ties

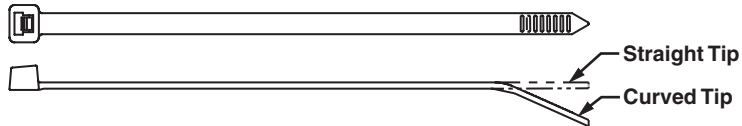

C1.
Wiring
Duct

C2.
Surface
Raceway

Part Number	Length		Width		Thickness		Max. Bundle Dia.		Min. Loop Tensile Str.		Recommended Installation Tool	Tool Setting	Std. Pkg. Qty.	Std. Ctn. Qty.
	In.	mm	In.	mm	In.	mm	In.	mm	Lbs.	N				

C3.
Abrasion
Protection

Miniature Cross Section

PLT1M-M109	3.9	99	.098	2.5	.043	1.1	.87	22	11	49	GTS, GTSL, GS2B, PTS, PPTS, STS2	2	1000	50000
-------------------	-----	----	------	-----	------	-----	-----	----	----	----	----------------------------------	---	------	-------

Intermediate Cross Section

PLT1.5I-M109	5.6	142	.142	3.6	.045	1.1	1.38	35	18	80	GTS, GTSL, GS2B, PTS, PPTS, STS2	3	1000	25000
---------------------	-----	-----	------	-----	------	-----	------	----	----	----	----------------------------------	---	------	-------

C4.
Cable
Management

Standard Cross Section

PLT2S-M109	7.4	188	.190	4.8	.052	1.3	1.88	48	30	133	GTS, GTSL, GS2B, GTH, GS4H, PTS, PTH, PPTS, STS2, STH2	5 (GTS, GS2B, PTS, PPTS) 2 (GTH, GS4H)	1000	10000
PLT3S-M109	11.5	292	.190	4.8	.052	1.3	3.00	76	30	133			1000	10000
PLT4S-M109	14.5	368	.190	4.8	.052	1.3	4.00	102	30	133			1000	5000

D1.
Terminals

Light-Heavy Cross Section (Straight Tip)

PLT2H-TL109	8.1	206	.300	7.6	.075	1.9	2.00	51	50	222	GTH, GS4H, GS4EH, PTH, STH2, ST3EH	5	250	2500
PLT3H-TL109	11.4	290	.300	7.6	.075	1.9	3.00	76	50	222		5	250	2500
PLT4H-TL109	14.5	368	.300	7.6	.075	1.9	4.00	102	50	222		5	250	2500

D2.
Power
Connectors

D3.
Grounding
Connectors

E1.
Labeling
Systems

E2.
Labels

E3.
Pre-Printed
& Write-On
Markers

E4.
Permanent
Identification

E5.
Lockout/
Tagout
& Safety
Solutions

F.
Index

PAN-TY® Cable Ties – Weather Resistant Polypropylene

- For chemical resistance where high loop tensile strength is not required especially in the presence of hydrochloric acid, salts, and bases
- Greater resistance to damage caused by ultraviolet light – indoor or outdoor use
- Material requires lowering the tool setting (see table below)
- One-piece construction for consistent performance and reliability
- Lowest threading force of any one-piece cable tie in the industry
- Curved tip is easy to pick up from flat surfaces and allows faster initial threading to speed installation

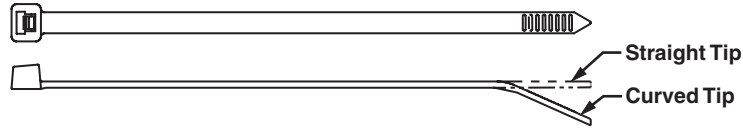

Part Number	Length		Width		Thickness		Max. Bundle Dia.		Min. Loop Tensile Str.		Recommended Installation Tool	Tool Setting	Std. Pkg. Qty.	Std. Ctn. Qty.
	In.	mm	In.	mm	In.	mm	In.	mm	Lbs.	N				
Miniature Cross Section														
PLT1M-M100	3.9	99	.098	2.5	.043	1.1	.87	22	11	49	GTS, GTSL, GS2B, PTS, PPTS, STS2	2	1000	50000
Intermediate Cross Section														
PLT1.5I-M100	5.6	142	.142	3.6	.045	1.1	1.38	35	18	80	GTS, GTSL, GS2B, PTS, PPTS, STS2	3	1000	25000
Standard Cross Section														
PLT2S-M100	7.4	188	.190	4.8	.052	1.3	1.88	48	30	133	GTS, GTSL, GS2B, GTH, GS4H, PTS, PTS, PPTS, STS2, STH2	5 (GTS, GS2B, PTS, PPTS) 2 (GTH, GS4H)	1000	10000
PLT3S-M100	11.5	292	.190	4.8	.052	1.3	3.00	76	30	133			1000	10000
PLT4S-M100	14.5	368	.190	4.8	.052	1.3	4.00	102	30	133			1000	5000
Light-Heavy Cross Section (Straight Tip)														
PLT2H-TL100	8.1	206	.300	7.6	.075	1.9	2.00	51	50	222	GTH, GS4H, GS4EH, PTH, STH2, ST3EH	5	250	2500
PLT3H-TL100	11.4	290	.300	7.6	.075	1.9	3.00	76	50	222		5	250	2500
PLT4H-TL100	14.5	368	.300	7.6	.075	1.9	4.00	102	50	222		5	250	2500

A.
System
Overview

B1.
Cable Ties

B2.
Cable
Accessories

B3.
Stainless
Steel Ties

C1.
Wiring
Duct

C2.
Surface
Raceway

C3.
Abrasion
Protection

C4.
Cable
Management

D1.
Terminals

D2.
Power
Connectors

D3.
Grounding
Connectors

E1.
Labeling
Systems

E2.
Labels

E3.
Pre-Printed
& Write-On
Markers

E4.
Permanent
Identification

E5.
Lockout/
Tagout
& Safety
Solutions

F.
Index

A.
System
Overview



PAN-TY® Cable Ties – HALAR® – Distinctive Maroon Color

B1.
Cable Ties

- UL Listed for use in plenum or air handling spaces per NEC, Section 300-22 (C) and (D)
- Low smoke density and excellent flammability rating of UL 94V-0
- Commonly accepted solution for bundling qualified cable without conduit in air handling space applications

- Greater resistance to damage caused by ultraviolet light – indoor or outdoor use
- One-piece construction for consistent performance and reliability
- Lowest threading force of any one-piece cable tie in the industry
- Curved tip is easy to pick up from flat surfaces and allows faster initial threading to speed installation

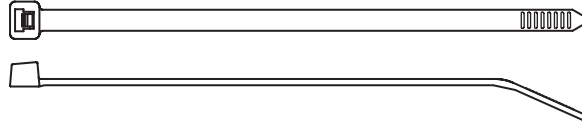

B2.
Cable
Accessories

B3.
Stainless
Steel Ties

C1.
Wiring
Duct

C2.
Surface
Raceway

Part Number	Length		Width		Thickness		Max. Bundle Dia.		Min. Loop Tensile Str.		Recommended Installation Tool	Std. Pkg. Qty.	Std. Ctn. Qty.
	In.	mm	In.	mm	In.	mm	In.	mm	Lbs.	N			
Miniature Cross Section													
PLT1M-C702Y	4.0	102	.098	2.5	.043	1.1	.87	22	18	80	GTS, GTSL, GS2B, PTS, PPTS, STS2	100	1000
Standard Cross Section													
PLT2S-C702Y	7.4	188	.190	4.8	.055	1.4	1.88	48	50	222	GTS, GTSL, GS2B, GTH, GS4H, PTS, PTH, PPTS, STS2, STH2	100	1000
PLT3S-C702Y	11.6	295	.190	4.8	.055	1.4	3.00	76	50	222		100	1000

*HALAR is a registered trademark of Solvay Solexis, Inc.

D1.
Terminals

D2.
Power
Connectors

D3.
Grounding
Connectors

E1.
Labeling
Systems

E2.
Labels

E3.
Pre-Printed
& Write-On
Markers

E4.
Permanent
Identification

E5.
Lockout/
Tagout/
& Safety
Solutions

F.
Index



PAN-TY® Cable Ties – TEFZEL® – Distinctive Aqua Blue Color

- Ideal for applications requiring resistance to environmental stresses such as chemical attack, gamma radiation, ultraviolet radiation and extreme high and low temperatures
- Ideal for use in nuclear power facilities and chemical processing plants and meets the requirements of IEEE 383
- Low smoke density and excellent flammability rating of UL 94V-0

- One-piece construction for consistent performance and reliability
- Lowest threading force of any one-piece cable tie in the industry
- Curved tip is easy to pick up from flat surfaces and allows faster initial threading to speed installation
- For indoor or outdoor use

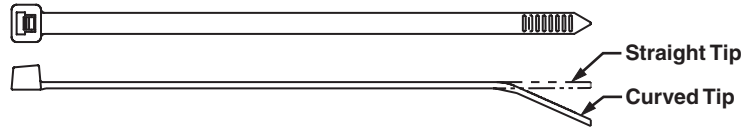
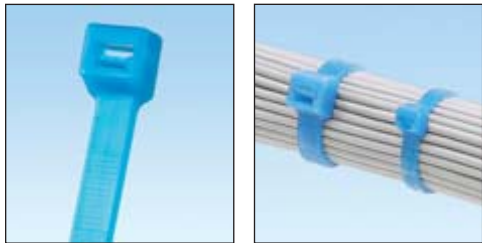

Part Number	Length		Width		Thickness		Max. Bundle Dia.		Min. Loop Tensile Str.		Recommended Installation Tool	Std. Pkg. Qty.	Std. Ctn. Qty.
	In.	mm	In.	mm	In.	mm	In.	mm	Lbs.	N			
Miniature Cross Section													
PLT1M-C76	4.0	102	.098	2.5	.043	1.1	.87	22	18	80	GTS, GTSL, GS2B, PTS, PPTS, STS2	100	1000
Intermediate Cross Section													
PLT2I-C76	8.0	203	.135	3.4	.045	1.1	2.00	51	25	111	GTS, GTSL, GS2B, PTS, PPTS, STS2	100	1000
Standard Cross Section													
PLT2S-C76	7.4	188	.190	4.8	.055	1.4	1.88	48	50	222	GTS, GTSL, GS2B, GTH, GS4H, PTS, PTH, PPTS, STS2, STH2	100	1000
PLT3S-C76	11.6	295	.190	4.8	.059	1.5	3.00	76	50	222		100	1000
PLT4S-C76	14.6	371	.190	4.8	.059	1.5	4.00	102	50	222		100	1000
Light-Heavy Cross Section (Straight Tip)													
PLT3H-L76	11.5	292	.300	7.6	.075	1.9	3.00	78	120	534	GTH, GS4H, GS4EH, PTH, STH2, ST3EH	50	500
PLT4H-L76	14.6	371	.300	7.6	.075	1.9	4.00	102	120	534		50	500

TEFZEL is a registered trademark of E. I. du Pont de Nemours and Company.

PAN-TY® Cable Tie Mounts – TEFZEL®

- Flammability rating of UL 94V-0 – indoor use
- Unique cradle design provides maximum stability for the cable bundle

- Low profile design keeps bundle close to mounting surface

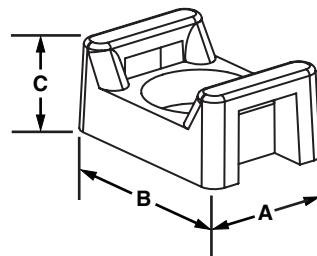

Part Number	Used With Cable Ties*	Length B		Width A		Height C		Counterbore Diameter		Mounting Method	Std. Pkg. Qty.	Std. Ctn. Qty.
		In.	mm	In.	mm	In.	mm	In.	mm			
TM2S8-C76	M, I, S	.63	16.0	.43	10.8	.28	7.0	.30	7.6	#8 (M4) screw	100	500
TM3S8-C76	S, LH	.86	21.7	.62	15.5	.38	9.5	.37	9.4	#8 (M4) screw	100	500
TM3S10-C76		.86	21.7	.62	15.8	.38	9.5	.37	9.4	#10 (M5) screw	100	500

*Cable tie cross section sizes: M = Miniature, I = Intermediate, S = Standard, LH = Light-Heavy.

TEFZEL is a registered trademark of E. I. du Pont de Nemours and Company.

A. System Overview

B1. Cable Ties

B2. Cable Accessories

B3. Stainless Steel Ties

C1. Wiring Duct

C2. Surface Raceway

C3. Abrasion Protection

C4. Cable Management

D1. Terminals

D2. Power Connectors

D3. Grounding Connectors

E1. Labeling Systems

E2. Labels

E3. Pre-Printed & Write-On Markers

E4. Permanent Identification

E5. Lockout/Tagout & Safety Solutions

F. Index

A.
System
Overview



NEW! PAN-TY® Cable Ties – PEEK (Polyetheretherketone)

B1.
Cable Ties

- Ideal for harsh environments where a cable tie material is required to hold up to chemical or radiation exposure
- Non-conductive material that is excellent for high temperature applications up to 500°F (260°C)
- High strength properties over a wide range of temperatures

- Flammability rating of UL 94V-0 with low smoke and toxicity; halogen-free
- PEEK material meets MIL specification MIL-P-46183, and is approved for use by the Department of Defense
- One-piece construction for consistent performance and reliability
- Lowest threading force of any one-piece cable tie in the industry

B2.
Cable
Accessories

B3.
Stainless
Steel Ties



C1.
Wiring
Duct

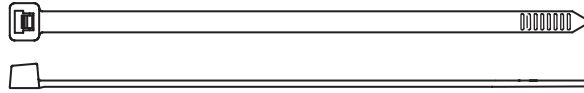

C2.
Surface
Raceway

Part Number	Length		Width		Thickness		Max. Bundle Dia.		Min. Loop Tensile Strength		Recommended Installation Tool	Std. Pkg. Qty.	Std. Ctn. Qty.
	In.	mm	In.	mm	In.	mm	In.	mm	Lbs.	N			
Standard Cross Section													
PLT2S-C71	7.4	188	.190	4.8	.055	1.4	1.88	48	150	668	GTS, GTSL, GS2B, GTH, GS4H, PTS, PTH, PPTS, STS2, STH2	100	1000

C4.
Cable
Management

D1.
Terminals

D2.
Power
Connectors

D3.
Grounding
Connectors

E1.
Labeling
Systems

E2.
Labels

E3.
Pre-Printed
& Write-On
Markers

E4.
Permanent
Identification

E5.
Lockout/
Tagout/
& Safety
Solutions

F.
Index



PAN-TY® Cable Ties – Metal Detectable Nylon 6.6

- For indoor use
- Metal impregnated material allows identification by metal detectors or x-ray inspection equipment to help meet food, beverage, and pharmaceutical safety standards, to help reduce product contamination, loss, and recall
- One-piece construction for consistent performance and reliability
- Lowest threading force of any one-piece cable tie in the industry
- Curved tip is easy to pick up from flat surfaces and allows faster initial threading to speed installation

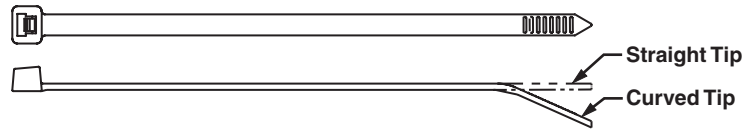

Part Number	Length		Width		Thickness		Max. Bundle Dia.		Min. Loop Tensile Strength		Recommended Installation Tool	Std. Pkg. Qty.	Std. Ctn. Qty.
	In.	mm	In.	mm	In.	mm	In.	mm	Lbs.	N			
Miniature Cross Section													
PLT1M-C86	3.9	100	.098	2.5	.044	1.1	.87	22	18	80	GTS, GTSL, GS2B, STS2	100	1000
Intermediate Cross Section													
PLT2I-C86	8.0	203	.135	3.4	.047	1.2	2.00	51	40	178	GTS, GTSL, GS2B, STS2	100	1000
Standard Cross Section													
PLT2S-C86	7.3	186	.190	4.8	.057	1.4	1.85	47	50	222	GTS, GTSL, GS2B, GTH, GS4H, STS2, STH2	100	1000
PLT3S-C86	11.5	291	.190	4.8	.057	1.4	3.00	76	50	222		100	1000
PLT4S-C86	14.4	366	.190	4.8	.057	1.4	4.00	102	50	222		100	1000
Light-Heavy Cross Section (Straight Tip)													
PLT3H-L86	11.1	282	.300	7.6	.075	1.9	3.00	76	120	120	GTH, GS4H, GS4EH, STH2, ST3EH	50	500
PLT4H-L86	14.4	366	.300	7.6	.075	1.9	4.00	102	120	120		50	500

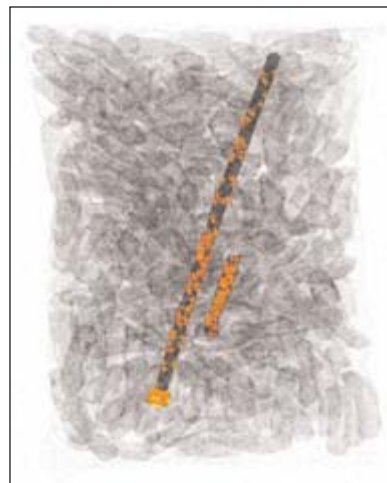

Example x-ray image of metal detectable cable tie in finished product

A. System Overview

B1. Cable Ties

B2. Cable Accessories

B3. Stainless Steel Ties

C1. Wiring Duct

C2. Surface Raceway

C3. Abrasion Protection

C4. Cable Management

D1. Terminals

D2. Power Connectors

D3. Grounding Connectors

E1. Labeling Systems

E2. Labels

E3. Pre-Printed & Write-On Markers

E4. Permanent Identification

E5. Lockout/Tagout & Safety Solutions

F. Index

A. System Overview



PAN-TY® Releasable Cable Ties – Nylon 6.6

B1. Cable Ties

- For indoor use
- Extended release tab permits easy release and re-use where changes are anticipated during development, production, or servicing in the field

- One-piece construction for consistent performance and reliability
- Curved tip is easy to pick up from flat surfaces and allows faster initial threading to speed installation

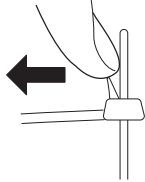

To release, grasp the head of the cable tie, deflect release tab, and pull the cable tie away from the bundle.

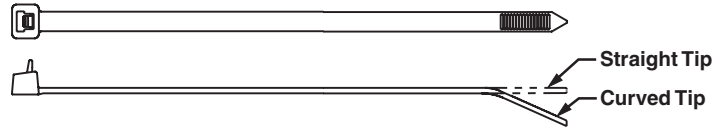

C1. Wiring Duct

Part Number	Length		Width		Thickness		Max. Bundle Dia.		Min. Loop Tensile Str.		Recommended Installation Tool	Std. Pkg. Qty.	Std. Ctn. Qty.
	In.	mm	In.	mm	In.	mm	In.	mm	Lbs.	N			

Standard Cross Section

PRT1S-C	4.8	122	.190	4.8	.052	1.3	1.00	25	50	222	Hand install only	100	1000
PRT1.5S-C	6.3	160	.190	4.8	.052	1.3	1.50	38	50	222		100	1000
PRT2S-C	7.4	188	.190	4.8	.052	1.3	1.88	48	50	222		100	1000
PRT3S-C	11.5	292	.190	4.8	.052	1.3	3.00	76	50	222		100	1000
PRT4S-C	14.5	368	.190	4.8	.052	1.3	4.00	102	50	222		100	1000

Light-Heavy Cross Section (Straight Tip)

PRT2H-L	8.4	213	.300	7.6	.075	1.9	2.00	51	80	356	Hand install only	50	500
PRT3H-L	11.4	290	.300	7.6	.075	1.9	3.00	76	80	356		50	500
PRT4H-L	14.5	368	.300	7.6	.075	1.9	4.00	102	80	356		50	500

Note: UL Listed for use in plenum or air handling spaces per NEC except PRT2H/3H/4H.

C2. Surface Raceway

C3. Abrasion Protection

C4. Cable Management

D1. Terminals

D2. Power Connectors

D3. Grounding Connectors

PAN-TY® Releasable Lashing Ties – Nylon 6.6

- For indoor use
- Release tab permits easy release and re-use where changes are anticipated during development, production, or servicing in the field

- Typically used for heavy duty applications
- Strongest PAN-TY® Cable Tie available
- Can be used with MCEH mounting clip, see page B1.24

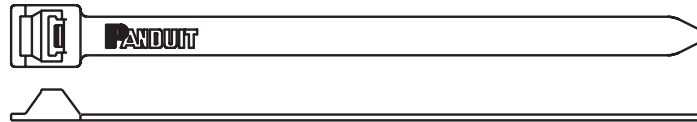

E1. Labeling Systems

E2. Labels

E3. Pre-Printed & Write-On Markers

E4. Permanent Identification

E5. Lockout/Tagout & Safety Solutions

F. Index

Part Number	Length		Width		Thickness		Max. Bundle Dia.		Min. Loop Tensile Str.		Recommended Installation Tool	Std. Pkg. Qty.	Std. Ctn. Qty.
	In.	mm	In.	mm	In.	mm	In.	mm	Lbs.	N			

Extra-Heavy Cross Section

PRT2EH-C	9.0	229	.500	12.7	.075	1.9	2.00	51	250	1112	Hand install only	100	1000
PRT5EH-Q	20.1	511	.500	12.7	.075	1.9	5.00	127	250	1112		25	250
PRT6EH-Q	22.2	564	.500	12.7	.075	1.9	6.00	152	250	1112		25	250
PRT8EH-C	28.3	719	.500	12.7	.085	2.2	8.00	203	250	1112		100	1000
PRT10EH-C	34.2	869	.500	12.7	.085	2.2	10.00	254	250	1112		100	500
PRT12EH-C	40.1	1019	.500	12.7	.085	2.2	12.00	305	250	1112		100	500



PAN-TY® Releasable Cable Ties – Weather Resistant and Heat Stabilized Nylon 6.6

- Weather resistant material has greater resistance to damage caused by ultraviolet light – indoor or outdoor use
- Heat stabilized material for high temperature applications up to 239°F (115°C) – indoor use

- Extended release tab permits easy release and re-use where changes are anticipated during development, production, or servicing in the field
- One-piece construction for consistent performance and reliability
- Curved tip is easy to pick up from flat surfaces and allows faster initial threading to speed installation

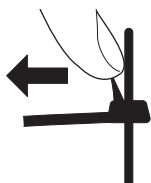

To release, grasp the head of the cable tie, deflect release tab, and pull the cable tie away from the bundle.

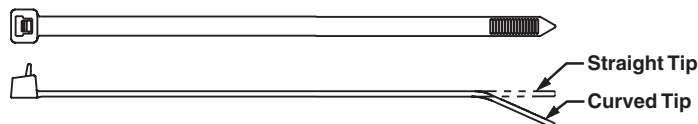

Part Number	Length		Width		Thickness		Max. Bundle Dia.		Min. Loop Tensile Str.		Recommended Installation Tool	Std. Pkg. Qty.	Std. Ctn. Qty.
	In.	mm	In.	mm	In.	mm	In.	mm	Lbs.	N			

Weather Resistant Nylon 6.6

Standard Cross Section

PRT1S-C0	4.8	122	.190	4.8	.052	1.3	1.00	25	50	222	Hand install only	100	1000
PRT1.5S-C0	6.3	160	.190	4.8	.052	1.3	1.50	38	50	222		100	1000
PRT2S-C0	7.4	188	.190	4.8	.052	1.3	1.88	48	50	222		100	1000
PRT3S-C0	11.5	292	.190	4.8	.052	1.3	3.00	76	50	222		100	1000
PRT4S-C0	14.5	368	.190	4.8	.052	1.3	4.00	102	50	222		100	1000

Light-Heavy Cross Section (Straight Tip)

PRT2H-L0	8.4	213	.300	7.6	.075	1.9	2.00	51	80	356	Hand install only	50	500
PRT3H-L0	11.4	290	.300	7.6	.075	1.9	3.00	76	80	356		50	500
PRT4H-L0	14.5	368	.300	7.6	.075	1.9	4.00	102	80	356		50	500

Heat Stabilized Nylon 6.6

Standard Cross Section

PRT1.5S-M30	6.3	160	.190	4.8	.052	1.3	1.50	38	50	222	Hand install only	1000	10000
-------------	-----	-----	------	-----	------	-----	------	----	----	-----	-------------------	------	-------

Note: UL Listed, UL Recognized, and CSA Certified, except PRT2H/3H/4H.

A. System Overview

B1. Cable Ties

B2. Cable Accessories

B3. Stainless Steel Ties

C1. Wiring Duct

C2. Surface Raceway

C3. Abrasion Protection

C4. Cable Management

D1. Terminals

D2. Power Connectors

D3. Grounding Connectors

E1. Labeling Systems

E2. Labels

E3. Pre-Printed & Write-On Markers

E4. Permanent Identification

E5. Lockout/Tagout & Safety Solutions

F. Index

A. System Overview

PAN-TY® Releasable Lashing Ties – Weather Resistant Nylon 6.6

B1. Cable Ties

- Greater resistance to damage caused by ultraviolet light – indoor or outdoor use
- Release tab permits easy release and re-use where changes are anticipated during development, production, or servicing in the field
- Typically used for heavy duty applications
- Strongest PAN-TY® Cable Tie available
- Can be used with MCEH mounting clip shown below

B2. Cable Accessories

B3. Stainless Steel Ties

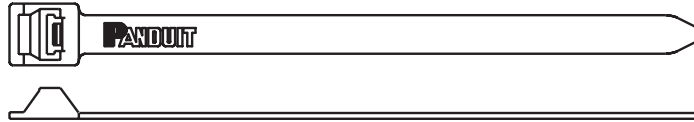

C1. Wiring Duct

C2. Surface Raceway

Part Number	Length		Width		Thickness		Max. Bundle Dia.		Min. Loop Tensile Str.		Recommended Installation Tool	Std. Pkg. Qty.	Std. Ctn. Qty.
	In.	mm	In.	mm	In.	mm	In.	mm	Lbs.	N			
Extra-Heavy Cross Section													
PRT2EH-Q0	9.0	229	.500	12.7	.075	1.9	2.00	51	250	1112	Hand install only	25	250
PRT5EH-Q0	20.1	511	.500	12.7	.075	1.9	5.00	127	250	1112		25	250
PRT6EH-Q0	22.2	564	.500	12.7	.075	1.9	6.00	152	250	1112		25	250
PRT8EH-Q0	28.3	719	.500	12.7	.085	2.2	8.00	203	250	1112		25	250
PRT10EH-Q0	34.2	869	.500	12.7	.085	2.2	10.00	254	250	1112		25	250
PRT12EH-Q0	40.1	1019	.500	12.7	.085	2.2	12.00	305	250	1112		25	250

D1. Terminals

D2. Power Connectors

MCEH® Lashing Tie Mounting Clip – Weather Resistant Nylon 6.6

D3. Grounding Connectors

- Greater resistance to damage caused by ultraviolet light – indoor or outdoor use
- Converts PANDUIT lashing ties into clamps
- Easily snaps in place for a secure clamp
- Use with lashing ties shown above and on pages B1.9, B1.11, B1.22 and B1.25

E1. Labeling Systems

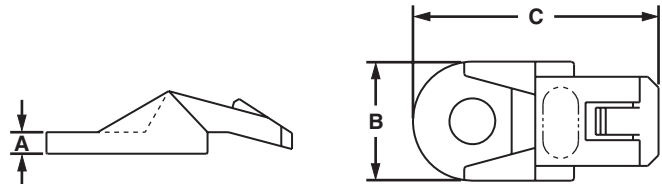

E2. Labels

E3. Pre-Printed & Write-On Markers

Part Number	Height A		Width B		Length C		Mounting Method	Std. Pkg. Qty.	Std. Ctn. Qty.
	In.	mm	In.	mm	In.	mm			
MCEH-S25-C0	.13	3.3	.67	17.0	1.38	35	1/4" (M6) screw (not flathead)	100	1000

E4. Permanent Identification

E5. Lockout/Tagout & Safety Solutions

F. Index

PAN-TY® Releasable Lashing Ties – Weather Resistant Polypropylene

- For chemical resistance where high loop tensile strength is not required especially in the presence of hydrochloric acid, salts, and bases
- Greater resistance to damage caused by ultraviolet light – indoor or outdoor use
- Release tab permits easy release and re-use where changes are anticipated during development, production, or servicing in the field
- Typically used for heavy duty applications
- Can be used with MCEH mounting clip, see page B1.24

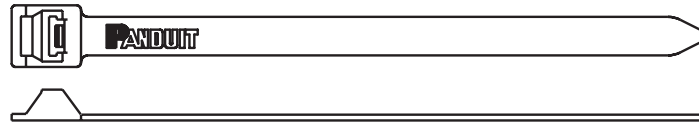

Part Number	Length		Width		Thickness		Max. Bundle Dia.		Min. Loop Tensile Str.		Recommended Installation Tool	Std. Pkg. Qty.	Std. Ctn. Qty.
	In.	mm	In.	mm	In.	mm	In.	mm	Lbs.	N			
Extra-Heavy Cross Section													
PRT2EH-C100	9.0	229	.500	12.7	.075	1.9	2.00	51	90	400	Hand install only	100	1000
PRT5EH-C100	20.1	511	.500	12.7	.075	1.9	5.00	127	90	400		100	1000
PRT6EH-C100	22.2	564	.500	12.7	.075	1.9	6.00	152	90	400		100	1000
PRT8EH-C100	28.3	719	.500	12.7	.085	2.2	8.00	203	90	400		100	1000

A.
System
Overview

B1.
Cable
Ties

B2.
Cable
Accessories

B3.
Stainless
Steel Ties

C1.
Wiring
Duct

C2.
Surface
Raceway

C3.
Abrasion
Protection

C4.
Cable
Management

D1.
Terminals

D2.
Power
Connectors

D3.
Grounding
Connectors

E1.
Labeling
Systems

E2.
Labels

E3.
Pre-Printed
& Write-On
Markers

E4.
Permanent
Identification

E5.
Lockout/
Tagout
& Safety
Solutions

F.
Index

A.
System
Overview

UL **US** **LISTED** **CSA** **US** **PAN-TY® Clamp Ties – Nylon 6.6**

B1.
Cable Ties

- For indoor use
- Used to secure a cable bundle to another surface such as a control panel, communication rack, wall or ceiling
- Design allows for bundling before or after screwing clamp in place

- One-piece construction for consistent performance and reliability
- Curved tip is easy to pick up from flat surfaces and allows faster initial threading to speed installation

B2.
Cable
Accessories

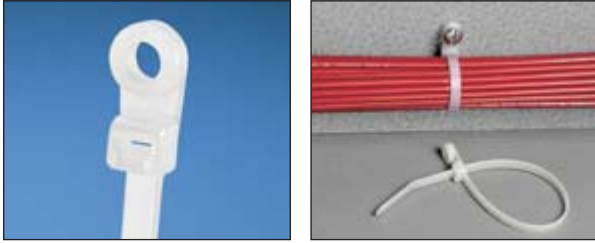

B3.
Stainless
Steel Ties

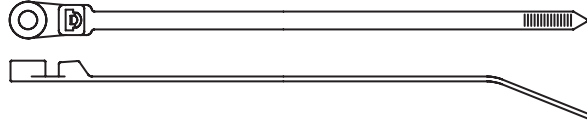

C1.
Wiring
Duct

C2.
Surface
Raceway

Part Number	Length		Width		Thickness		Nominal Hole Dia.		Screw Size	Metric Screw Size	Max. Bundle Dia.		Min. Loop Tensile Str.		Recommended Installation Tool	Std. Pkg. Qty.	Std. Ctn. Qty.
	In.	mm	In.	mm	In.	mm	In.	mm			In.	mm	Lbs.	N			

Miniature Cross Section

PLC1M-S4-C	4.3	109	.100	2.5	.045	1.1	.122	3.1	#4	M2.5	.75	19	18	80	GTS, GTSL, GS2B, PTS, PPTS, STS2	100	1000
-------------------	-----	-----	------	-----	------	-----	------	-----	----	------	-----	----	----	----	----------------------------------	-----	------

Intermediate Cross Section

PLC1.5I-S8-C	6.1	155	.135	3.4	.045	1.1	.174	4.4	#8	M4	1.25	32	40	178	GTS, GTSL, GS2B, PTS, PPTS, STS2	100	1000
---------------------	-----	-----	------	-----	------	-----	------	-----	----	----	------	----	----	-----	----------------------------------	-----	------

Standard Cross Section

PLC2S-S6-C	7.9	201	.190	4.8	.047	1.2	.148	3.8	#6	M3	1.84	47	50	222	GTS, GTSL, GS2B, GTH, GS4H, PTS, PTH, PPTS, STS2, STH2	100	1000
PLC2S-S10-C	7.9	201	.190	4.8	.047	1.2	.200	5.1	#10	M5	1.84	47	50	222		100	1000
PLC3S-S10-C	12.0	305	.190	4.8	.047	1.2	.200	5.1	#10	M5	3.00	76	50	222		100	1000
PLC4S-S10-C	15.0	381	.190	4.8	.052	1.3	.200	5.1	#10	M5	4.00	102	50	222		100	1000

Light-Heavy Cross Section

PLC2H-S25-L	9.0	229	.300	7.6	.075	1.9	.260	6.6	1/4	M6	2.00	51	120	534	GTH, GS4H, GS4EH, PTH, STH2, ST3EH	50	500
PLC4H-S25-L	15.1	384	.300	7.6	.075	1.9	.260	6.6	1/4	M6	4.00	102	120	534		50	500

D1.
Terminals

D2.
Power
Connectors

D3.
Grounding
Connectors

E1.
Labeling
Systems

E2.
Labels

E3.
Pre-Printed
& Write-On
Markers

E4.
Permanent
Identification

E5.
Lockout/
Tagout/
& Safety
Solutions

F.
Index

UL[®] US[®] CS[®] PAN-TY[®] Clamp Ties – Weather Resistant and Heat Stabilized Nylon 6.6

- Weather resistant material has greater resistance to damage caused by ultraviolet light – indoor or outdoor use
- Heat stabilized material for high temperature applications up to 239°F (115°C) – indoor use
- Used to secure a cable bundle to another surface such as a control panel, communication rack, wall or ceiling
- Design allows for bundling before or after screwing clamp in place
- One-piece construction for consistent performance and reliability
- Curved tip is easy to pick up from flat surfaces and allows faster initial threading to speed installation

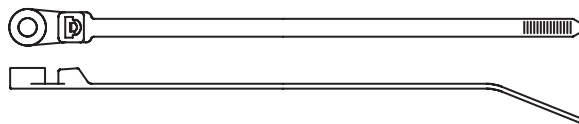

Part Number	Length		Width		Thickness		Nominal Hole Dia.		Screw Size	Metric Screw Size	Max. Bundle Dia.		Min. Loop Tensile Str.		Recommended Installation Tool	Std. Pkg. Qty.	Std. Ctn. Qty.
	In.	mm	In.	mm	In.	mm	In.	mm			In.	mm	Lbs.	N			

Weather Resistant Nylon 6.6

Miniature Cross Section

PLC1M-S4-C0	4.3	109	.100	2.5	.045	1.1	.122	3.1	#4	M2.5	.75	19	18	80	GTS, GTSL, GS2B, PTS, PPTS, STS2	100	1000
-------------	-----	-----	------	-----	------	-----	------	-----	----	------	-----	----	----	----	----------------------------------	-----	------

Intermediate Cross Section

PLC1.5I-S8-C0	6.1	155	.135	3.4	.045	1.1	.174	4.4	#8	M4	1.25	32	40	178	GTS, GTSL, GS2B, PTS, PPTS, STS2	100	1000
---------------	-----	-----	------	-----	------	-----	------	-----	----	----	------	----	----	-----	----------------------------------	-----	------

Standard Cross Section

PLC2S-S6-C0	7.9	201	.190	4.8	.047	1.2	.148	3.8	#6	M3	1.84	47	50	222	GTS, GTSL, GS2B, GTH, GS4H, PTS, PTH, PPTS, STS2, STH2	100	1000
PLC2S-S10-C0	7.9	201	.190	4.8	.047	1.2	.200	5.1	#10	M5	1.84	47	50	222		100	1000
PLC3S-S10-C0	12.0	305	.190	4.8	.052	1.3	.200	5.1	#10	M5	3.00	76	50	222		100	1000
PLC4S-S10-C0	15.0	381	.190	4.8	.052	1.3	.200	5.1	#10	M5	4.00	102	50	222		100	1000

Light-Heavy Cross Section

PLC2H-S25-TL0	9.0	229	.300	7.6	.075	1.9	.260	6.6	1/4	M6	2.00	51	120	534	GTH, GS4H, GS4EH, PTH, STH2, ST3EH	250	2500
PLC4H-S25-L0	15.1	384	.300	7.6	.075	1.9	.260	6.6	1/4	M6	4.00	102	120	534		50	500

Heat Stabilized Nylon 6.6

Miniature Cross Section

PLC1M-S4-M30	4.3	109	.100	2.5	.045	1.1	.122	3.1	#4	M2.5	.75	19	18	80	GTS, GTSL, GS2B, PTS, PPTS, STS2	1000	50000
--------------	-----	-----	------	-----	------	-----	------	-----	----	------	-----	----	----	----	----------------------------------	------	-------

Intermediate Cross Section

PLC1.5I-S8-M30	6.1	155	.135	3.4	.045	1.1	.174	4.4	#8	M4	1.25	32	40	178	GTS, GTSL, GS2B, PTS, PPTS, STS2	1000	25000
----------------	-----	-----	------	-----	------	-----	------	-----	----	----	------	----	----	-----	----------------------------------	------	-------

Standard Cross Section

PLC2S-S10-M30	7.9	201	.190	4.8	.047	1.2	.200	5.1	#10	M5	1.84	47	50	222	GTS, GTSL, GS2B, GTH, GS4H, PTS, PTH, PPTS, STS2, STH2	1000	10000
PLC4S-S10-M30	15.0	381	.190	4.8	.052	1.3	.200	5.1	#10	M5	4.00	102	50	222		1000	5000

Light-Heavy Cross Section

PLC2H-S25-TL30	9.0	229	.300	7.6	.075	1.9	.260	6.6	1/4	M6	2.00	51	120	534	GTH, GS4H, GS4EH, PTH, STH2, ST3EH	250	2500
PLC4H-S25-TL30	15.1	384	.300	7.6	.075	1.9	.260	6.6	1/4	M6	4.00	102	120	534		250	2500

Note: UL Recognized and CSA Certified except PLC2H/4H in Weather Resistant material (0).

A.
System
Overview

B1.
Cable Ties

B2.
Cable
Accessories

B3.
Stainless
Steel Ties

C1.
Wiring
Duct

C2.
Surface
Raceway

C3.
Abrasion
Protection

C4.
Cable
Management

D1.
Terminals

D2.
Power
Connectors

D3.
Grounding
Connectors

E1.
Labeling
Systems

E2.
Labels

E3.
Pre-Printed
& Write-On
Markers

E4.
Permanent
Identification

E5.
Lockout/
Tagout/
& Safety
Solutions

F.
Index

A. System Overview

UL **CSA** **PAN-TY® Wing Push Mount Ties – Nylon 6.6**

B1. Cable Ties

- For indoor use
- Cable tie, mount, and fastener in a single part
- Used to attach bundles to another surface such as a flat panel
- Anchor is easily pressed into a pre-formed hole and locks in place

- Wings provide constant tension for a stable, secure, and rattle-free installation
- Curved tip is easy to pick up from flat surfaces and allows faster initial threading to speed installation

B2. Cable Accessories



B3. Stainless Steel Ties

C1. Wiring Duct



C2. Surface Raceway

C3. Abrasion Protection

C4. Cable Management

D1. Terminals

D2. Power Connectors

D3. Grounding Connectors

E1. Labeling Systems

E2. Labels

E3. Pre-Printed & Write-On Markers

E4. Permanent Identification

E5. Lockout/Tagout & Safety Solutions

F. Index

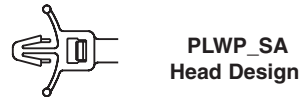
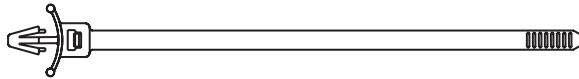

Part Number	Length		Width		Thickness		Nominal Hole Dia.		Max. Panel Thickness		Max. Bundle Dia.		Min. Loop Tensile Str.		Recommended Installation Tool	Std. Pkg. Qty.	Std. Ctn. Qty.
	In.	mm	In.	mm	In.	mm	In.	mm	In.	mm	In.	mm	Lbs.	N			

Miniature Cross Section

PLWP1M-C	4.3	109	.098	2.5	.044	1.1	.187	4.7	.093	2.4	.87	22	18	80	GTS, GTSL, GS2B, PTS, PPTS, STS2	100	1000
-----------------	-----	-----	------	-----	------	-----	------	-----	------	-----	-----	----	----	----	----------------------------------	-----	------

Intermediate Cross Section

PLWP1.5I-C	6.0	152	.135	3.4	.045	1.2	.187	4.7	.093	2.4	1.25	32	40	178	GTS, GTSL, GS2B, PTS, PPTS, STS2	100	1000
-------------------	-----	-----	------	-----	------	-----	------	-----	------	-----	------	----	----	-----	----------------------------------	-----	------

Standard Cross Section

PLWP1S-C	5.2	132	.190	4.8	.052	1.3	.250	6.4	.105	2.7	1.00	25	50	222	GTS, GTSL, GS2B, GTH, GS4H, PTS, PTH, PPTS, STS2, STH2	100	1000
PLWP1SA-D	5.1	130	.190	4.8	.052	1.3	.187	4.7	.093	2.4	1.00	25	50	222		500	5000
PLWP1SB-D	5.2	132	.190	4.8	.052	1.3	.187	4.7	.157	4.0	1.00	25	50	222		500	5000
PLWP1.5S-D	6.8	173	.190	4.8	.052	1.3	.250	6.4	.105	2.7	1.50	38	50	222		500	5000
PLWP1.5SA-D	6.7	170	.190	4.8	.052	1.3	.187	4.7	.093	2.4	1.50	38	50	222		500	5000
PLWP2S-C	7.8	198	.190	4.8	.052	1.3	.250	6.4	.105	2.7	1.75	45	50	222		100	1000
PLWP2SA-D	7.7	196	.190	4.8	.052	1.3	.187	4.7	.093	2.4	1.75	45	50	222		500	5000
PLWP2SB-D	7.8	198	.190	4.8	.052	1.3	.187	4.7	.157	4.0	1.75	45	50	222		500	5000

Light-Heavy Cross Section

PLWP2H-TL	8.9	226	.300	7.6	.075	1.9	.266	6.8	.105	2.7	2.00	51	120	534	GTH, GS4H, GS4EH, PTH, STH2, ST3EH	250	2500
PLWP3H-TL	12.0	305	.300	7.6	.075	1.9	.266	6.8	.105	2.7	3.00	76	120	534		250	2500

Note: UL Recognized and CSA Certified except PLWP2H/3H.



PAN-TY® Wing Push Mount Ties – Weather Resistant and Heat Stabilized Nylon 6.6

- Weather resistant material has greater resistance to damage caused by ultraviolet light – indoor or outdoor use
- Heat stabilized material for high temperature applications up to 239°F (115°C) – indoor use
- Cable tie, mount, and fastener in a single part
- Used to attach bundles to another surface such as a flat panel

- Anchor is easily pressed into a pre-formed hole and locks in place
- Wings provide constant tension for a stable, secure, and rattle-free installation
- Curved tip is easy to pick up from flat surfaces and allows faster initial threading to speed installation

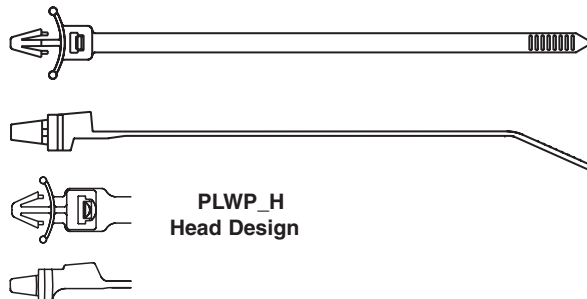

Part Number	Length		Width		Thickness		Nominal Hole Dia.		Max. Panel Thickness		Max. Bundle Dia.		Min. Loop Tensile Str.		Recommended Installation Tool	Std. Pkg. Qty.	Std. Ctn. Qty.
	In.	mm	In.	mm	In.	mm	In.	mm	In.	mm	In.	mm	Lbs.	N			

Weather Resistant Nylon 6.6

Miniature Cross Section

PLWP1M-D0	4.3	109	.098	2.5	.044	1.1	.187	4.7	.093	2.4	.87	22	18	80	GTS, GTSL, GS2B, PTS, PPTS, STS2	500	5000
------------------	-----	-----	------	-----	------	-----	------	-----	------	-----	-----	----	----	----	----------------------------------	-----	------

Standard Cross Section

PLWP1S-C0	5.2	132	.190	4.8	.052	1.3	.250	6.4	.105	2.7	1.00	25	50	222	GTS, GTSL, GS2B, GTH, GS4H, PTS, PTH, PPTS, STS2, STH2	100	1000
PLWP2S-C0	7.8	198	.190	4.8	.052	1.3	.250	6.4	.105	2.7	1.75	45	50	222		100	1000

Light-Heavy Cross Section

PLWP2H-TL0	8.9	226	.300	7.6	.075	1.9	.266	6.8	.105	2.7	2.00	51	120	534	GTH, GS4H, GS4EH, PTH, STH2, ST3EH	250	2500
PLWP3H-TL0	12.0	305	.300	7.6	.075	1.9	.266	6.8	.105	2.7	3.00	76	120	534		250	2500

Heat Stabilized Nylon 6.6

Miniature Cross Section

PLWP1M-D30	4.3	109	.098	2.5	.044	1.1	.187	4.7	.093	2.4	.87	22	18	80	GTS, GTSL, GS2B, PTS, PPTS, STS2	500	5000
-------------------	-----	-----	------	-----	------	-----	------	-----	------	-----	-----	----	----	----	----------------------------------	-----	------

Intermediate Cross Section

PLWP1.5I-D30	6.0	152	.135	3.4	.045	1.2	.187	4.7	.093	2.4	1.25	32	40	178	GTS, GTSL, GS2B, PTS, PPTS, STS2	500	5000
---------------------	-----	-----	------	-----	------	-----	------	-----	------	-----	------	----	----	-----	----------------------------------	-----	------

Standard Cross Section

PLWP1S-D30	5.2	132	.190	4.8	.052	1.3	.250	6.4	.105	2.7	1.00	25	50	222	GTS, GTSL, GS2B, GTH, GS4H, PTS, PTH, PPTS, STS2, STH2	500	5000
PLWP1.5S-D30	6.8	173	.190	4.8	.052	1.3	.250	6.4	.105	2.7	1.50	38	50	222		500	5000
PLWP2S-D30	7.8	198	.190	4.8	.052	1.3	.250	6.4	.105	2.7	1.75	45	50	222		500	5000

Light-Heavy Cross Section

PLWP2H-TL30	8.9	226	.300	7.6	.075	1.9	.266	6.8	.105	2.7	2.00	51	120	534	GTH, GS4H, GS4EH, PTH, STH2, ST3EH	250	2500
--------------------	-----	-----	------	-----	------	-----	------	-----	------	-----	------	----	-----	-----	------------------------------------	-----	------

Note: UL Recognized and CSA Certified except PLWP2H/3H.

A.
System
Overview

B1.
Cable Ties

B2.
Cable
Accessories

B3.
Stainless
Steel Ties

C1.
Wiring
Duct

C2.
Surface
Raceway

C3.
Abrasion
Protection

C4.
Cable
Management

D1.
Terminals

D2.
Power
Connectors

D3.
Grounding
Connectors

E1.
Labeling
Systems

E2.
Labels

E3.
Pre-Printed
& Write-On
Markers

E4.
Permanent
Identification

E5.
Lockout/
Tagout/
& Safety
Solutions

F.
Index

A. System Overview

UL US CSF US PAN-TY® Releasable Wing Push Mount Ties

B1. Cable Ties

- Natural nylon material for indoor use
- Weather resistant material has greater resistance to damage caused by ultraviolet light – indoor or outdoor use
- Heat stabilized material for high temperature applications up to 239°F (115°C) – indoor use
- Cable tie, mount, and fastener in a single part
- Used to attach bundles to another surface such as a flat panel

- Anchor is easily pressed into a pre-formed hole and locks in place
- Wings provide constant tension for a stable, secure, and rattle-free installation
- Extended release tab permits easy release and re-use where changes are anticipated during development, production, or servicing in the field
- Curved tip is easy to pick up from flat surfaces and allows faster initial threading to speed installation

B2. Cable Accessories

B3. Stainless Steel Ties

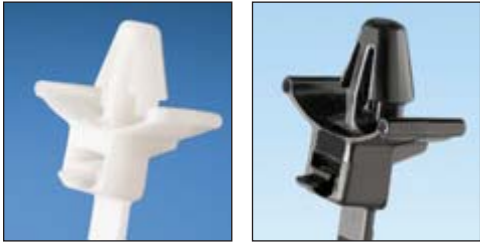

PRWP2S-D

PRWP2S-D0

C1. Wiring Duct

C2. Surface Raceway

C3. Abrasion Protection



C4. Cable Management

D1. Terminals

D2. Power Connectors

D3. Grounding Connectors

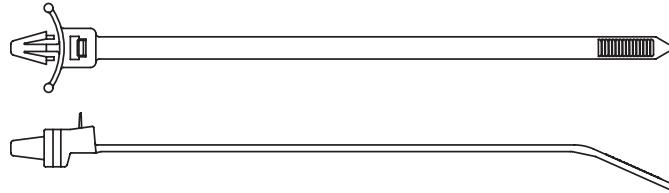

PRWP_SA Head Design

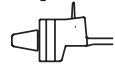

PRWP_SB Head Design

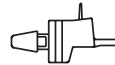

PRWP_H Head Design

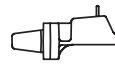

Part Number	Length		Width		Thickness		Nominal Hole Dia.		Max. Panel Thickness		Max. Bundle Dia.		Min. Loop Tensile Str.		Recommended Installation Tool	Std. Pkg. Qty.	Std. Ctn. Qty.
	In.	mm	In.	mm	In.	mm	In.	mm	In.	mm	In.	mm	Lbs.	N			

Nylon 6.6

Standard Cross Section

PRWP1S-C	5.2	132	.190	4.8	.052	1.3	.250	6.4	.105	2.7	1.00	25	50	222	Hand install only	100	1000
PRWP1SA-D	5.1	130	.190	4.8	.052	1.3	.187	4.7	.093	2.4	1.00	25	50	222		500	5000
PRWP1SB-D	5.2	132	.190	4.8	.052	1.3	.187	4.7	.157	4.0	1.00	25	50	222		500	5000
PRWP1.5S-D	6.8	173	.190	4.8	.052	1.3	.250	6.4	.105	2.7	1.50	38	50	222		500	5000
PRWP2S-D	7.8	198	.190	4.8	.052	1.3	.250	6.4	.105	2.7	1.75	45	50	222		500	5000

Light-Heavy Cross Section

PRWP2H-TL	8.9	226	.300	7.6	.075	1.9	.266	6.8	.105	2.7	2.00	51	120	534	Hand install only	250	2500
-----------	-----	-----	------	-----	------	-----	------	-----	------	-----	------	----	-----	-----	-------------------	-----	------

Weather Resistant Nylon 6.6

Standard Cross Section

PRWP1S-D0	5.2	132	.190	4.8	.052	1.3	.250	6.4	.105	2.7	1.00	25	50	222	Hand install only	500	5000
PRWP1.5S-D0	6.8	173	.190	4.8	.052	1.3	.250	6.4	.105	2.7	1.50	38	50	222		500	5000
PRWP2S-D0	7.8	198	.190	4.8	.052	1.3	.250	6.4	.105	2.7	1.75	45	50	222		500	5000

Heat Stabilized Nylon 6.6

Standard Cross Section

PRWP1.5S-D30	6.8	173	.190	4.8	.052	1.3	.250	6.4	.105	2.7	1.50	38	50	222	Hand install only	500	5000
--------------	-----	-----	------	-----	------	-----	------	-----	------	-----	------	----	----	-----	-------------------	-----	------

Note: UL Recognized and CSA Certified except PRWP2H.

UL US CSA US PAN-Ty® Center Mounted Wing Push Mount Ties – Heat Stabilized Nylon 6.6

- For high temperature applications up to 239°F (115°C) – indoor use
- Used to center the bundle over the mount on all bundle diameters
- Cable tie, mount, and fastener in a single part
- Anchor is easily pressed into a pre-formed hole and locks in place
- Wings provide constant tension for a stable, secure, and rattle-free installation
- Curved tip is easy to pick up from flat surfaces and allows faster initial threading to speed installation



PLWP-SC – Designed for normal wire bundles.

PLWP-SD – Designed for corrugated loom tubing. Bump prevents lateral and axial movement.

PLWP-SE – Designed for corrugated loom tubing, see page C3.11. Bump prevents lateral movement.

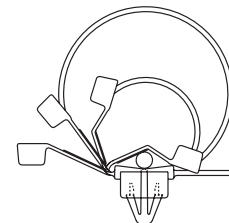

Bundle diameters from .12" to 1.97" (3mm to 50mm)

Part Number	Length		Width		Thickness		Nominal Hole Dia.		Max. Panel Thickness		Max. Bundle Dia.		Min. Loop Tensile Str.		Recommended Installation Tool	Std. Pkg. Qty.	Std. Ctn. Qty.
	In.	mm	In.	mm	In.	mm	In.	mm	In.	mm	In.	mm	Lbs.	N			
Standard Cross Section																	
PLWP30SC-D30	5.8	147	.190	4.8	.050	1.3	.266	6.8	.118	3.0	1.18	30	50	222	GTS, GTSL, GS2B, GTH, GS4H, PTS, PTH, PPTS, STS2, STH2	500	5000
PLWP40SC-D30	7.0	178	.190	4.8	.050	1.3	.266	6.8	.118	3.0	1.58	40	50	222		500	5000
PLWP40SD-D30	7.0	178	.190	4.8	.050	1.3	.266	6.8	.118	3.0	1.58	40	50	222		500	5000
PLWP50SC-D30	8.2	208	.190	4.8	.050	1.3	.266	6.8	.118	3.0	1.97	50	50	222		500	5000
PLWP50SE-D30	8.2	208	.190	4.8	.050	1.3	.266	6.8	.118	3.0	1.97	50	50	222		500	5000

A. System Overview

B1. Cable Ties

B2. Cable Accessories

B3. Stainless Steel Ties

C1. Wiring Duct

C2. Surface Raceway

C3. Abrasion Protection

C4. Cable Management

D1. Terminals

D2. Power Connectors

D3. Grounding Connectors

E1. Labeling Systems

E2. Labels

E3. Pre-Printed & Write-On Markers

E4. Permanent Identification

E5. Lockout/Tagout & Safety Solutions

F. Index

A. System Overview

B1. Cable Ties

B2. Cable Accessories

B3. Stainless Steel Ties

C1. Wiring Duct

C2. Surface Raceway

C3. Abrasion Protection

C4. Cable Management

D1. Terminals

D2. Power Connectors

D3. Grounding Connectors

E1. Labeling Systems

E2. Labels

E3. Pre-Printed & Write-On Markers

E4. Permanent Identification

E5. Lockout/Tagout & Safety Solutions

F. Index



PAN-TY® Ladder Style Releasable Wing Push Mount Ties – Heat Stabilized Nylon 6.6

- For high temperature applications up to 239°F (115°C) – indoor use
- Unique releasable ladder design eliminates the need for multiple clamp sizes
- Cable tie, mount, and fastener in a single part

- Used to attach bundles to another surface such as a flat panel
- Anchor is easily pressed into a pre-formed hole and locks in place
- Wings provide constant tension for a stable, secure, and rattle-free installation
- Curved tip is easy to pick up from flat surfaces and allows faster initial threading to speed installation

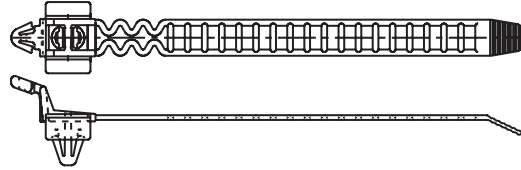
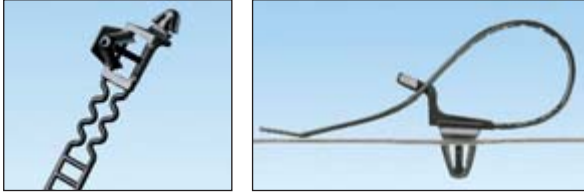

Part Number	Length		Width		Thickness		Nominal Hole Dia.		Max. Panel Thickness		Max. Bundle Dia.		Min. Loop Tensile Str.		Recommended Installation Tool	Std. Pkg. Qty.	Std. Ctn. Qty.
	In.	mm	In.	mm	In.	mm	In.	mm	In.	mm	In.	mm	Lbs.	N			
Standard Cross Section																	
PRLWP30S-D30	4.7	119	.380	9.7	.050	1.3	.266	6.8	.118	3.0	1.43	36	35	156	Hand install only	500	5000
PRLWP50S-D30	7.1	180	.380	9.7	.050	1.3	.266	6.8	.118	3.0	2.18	55	35	156		500	5000

PAN-TY® Umbrella Wing Push Mount Ties – Nylon and Heat Stabilized Nylon 6.6

- Natural nylon material for indoor use
- Heat stabilized material for high temperature applications up to 239°F (115°C) – indoor use
- Quick, secure way to fasten to clearance holes in panel
- Anchor is easily pressed into a pre-formed hole in a light gauge metal or plastic and locks in place

- Umbrella shaped disk provides constant tension for a stable, secure, and rattle-free installation
- Disk forms a dust-tight and semi-liquid tight seal to the panel surface
- PLUP40SE style is for use with corrugated loom tubing, see page C3.11
- Curved tip is easy to pick up from flat surfaces and allows faster initial threading to speed installation

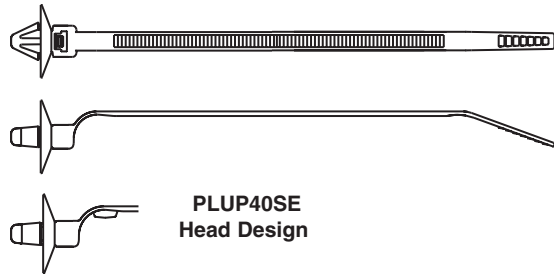

Part Number	Length		Width		Thickness		Nominal Hole Dia.		Max. Panel Thickness		Max. Bundle Dia.		Min. Loop Tensile Str.		Recommended Installation Tool	Std. Pkg. Qty.	Std. Ctn. Qty.
	In.	mm	In.	mm	In.	mm	In.	mm	In.	mm	In.	mm	Lbs.	N			
Standard Cross Section																	
PLUP40S-D30*	7.0	177	.190	4.8	.047	1.2	.266	6.8	.050	1.3	1.57	40	50	222	GTS, GTSL, GS2B, GTH, GS4H, PTS, PTH, PPTS, STS2, STH2	500	5000
PLUP40SE-D	7.0	177	.190	4.8	.047	1.2	.266	6.8	.050	1.3	1.57	40	50	222		500	5000
PLUP40SE-D30*	7.0	177	.190	4.8	.047	1.2	.266	6.8	.050	1.3	1.57	40	50	222		500	5000

*Heat stabilized material (30).

PAN-TY® Push Mount Ties

- Natural nylon material for indoor use
- Weather resistant material has greater resistance to damage caused by ultraviolet light – indoor or outdoor use
- Heat stabilized material for high temperature applications up to 239°F (115°C) – indoor use
- *Wingless* design allows tie to be used in confined spaces

- Cable tie, mount, and fastener in a single part
- Economical push mount ties are used to attach bundles to another surface such as a flat panel
- Anchor is easily pressed into a pre-formed hole and locks in place
- Curved tip is easy to pick up from flat surfaces and allows faster initial threading to speed installation



PLP2S-C

PLP2S-M0

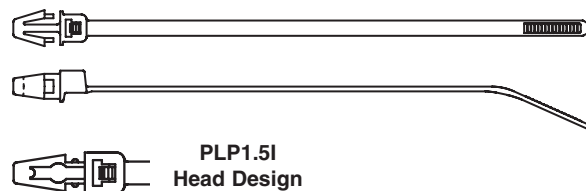

PLP1.5I Head Design

Part Number	Length		Width		Thickness		Nominal Hole Dia.		Max. Panel Thickness		Max. Bundle Dia.		Min. Loop Tensile Str.		Recommended Installation Tool	Std. Pkg. Qty.	Std. Ctn. Qty.
	In.	mm	In.	mm	In.	mm	In.	mm	In.	mm	In.	mm	Lbs.	N			

Nylon 6.6

Intermediate Cross Section

PLP1.5I-C	6.1	156	.135	3.4	.045	1.1	.187	4.7	.093	2.4	1.25	32	40	178	GTS, GTSL, GS2B, PTS, PPTS, STS2	100	1000
-----------	-----	-----	------	-----	------	-----	------	-----	------	-----	------	----	----	-----	----------------------------------	-----	------

Standard Cross Section

PLP1S-M	5.3	135	.180	4.6	.050	1.3	.250	6.4	.125	3.2	1.00	25	50	222	GTS, GTSL, GS2B, GTH, GS4H, PTS, PTH, PPTS, STS2, STH2	1000	10000
PLP1.5S-M	6.7	170	.180	4.6	.050	1.3	.250	6.4	.125	3.2	1.50	38	50	222		1000	10000
PLP2S-C	7.9	200	.180	4.6	.050	1.3	.250	6.4	.125	3.2	1.75	45	50	222		100	1000

Weather Resistant Nylon 6.6

Intermediate Cross Section

PLP1.5I-M0	6.1	156	.135	3.4	.045	1.1	.187	4.7	.093	2.4	1.25	32	40	178	GTS, GTSL, GS2B, PTS, PPTS, STS2	1000	25000
------------	-----	-----	------	-----	------	-----	------	-----	------	-----	------	----	----	-----	----------------------------------	------	-------

Standard Cross Section

PLP1S-M0	5.3	135	.180	4.6	.050	1.3	.250	6.4	.125	3.2	1.00	25	50	222	GTS, GTSL, GS2B, GTH, GS4H, PTS, PTH, PPTS, STS2, STH2	1000	10000
PLP2S-M0	7.9	200	.180	4.6	.050	1.3	.250	6.4	.125	3.2	1.75	45	50	222		1000	10000

Heat Stabilized Nylon 6.6

Intermediate Cross Section

PLP1.5I-M30	6.1	156	.135	3.4	.045	1.1	.187	4.7	.093	2.4	1.25	32	40	178	GTS, GTSL, GS2B, PTS, PPTS, STS2	1000	25000
-------------	-----	-----	------	-----	------	-----	------	-----	------	-----	------	----	----	-----	----------------------------------	------	-------

Standard Cross Section

PLP1S-M30	5.3	135	.180	4.6	.050	1.3	.250	6.4	.125	3.2	1.00	25	50	222	GTS, GTSL, GS2B, GTH, GS4H, PTS, PTH, PPTS, STS2, STH2	1000	10000
PLP2S-M30	7.9	200	.180	4.6	.050	1.3	.250	6.4	.125	3.2	1.75	45	50	222		1000	10000

A. System Overview

B1. Cable Ties

B2. Cable Accessories

B3. Stainless Steel Ties

C1. Wiring Duct

C2. Surface Raceway

C3. Abrasion Protection

C4. Cable Management

D1. Terminals

D2. Power Connectors

D3. Grounding Connectors

E1. Labeling Systems

E2. Labels

E3. Pre-Printed & Write-On Markers

E4. Permanent Identification

E5. Lockout/Tagout & Safety Solutions

F. Index

A.
System
Overview

UL US C_{UL} SP US PAN-TY® Marker and Flag Ties

- Natural nylon material for indoor use
- Weather resistant material has greater resistance to damage caused by ultraviolet light – indoor or outdoor use
- Flame retardant material has a flammability rating of UL 94V-0 – for indoor use
- Used to fasten and identify bundles at the same time
- One-piece construction for consistent performance and reliability
- Can be marked with *PANDUIT* marker pens on page B1.51 or computer printable labels
- Custom imprinting with text, symbols, or trademarks available using *PANDUIT* Custom Hot Stamping Service, see page B1.91
- Curved tip is easy to pick up from flat surfaces and allows faster initial threading to speed installation

B1.
Cable Ties

B2.
Cable
Accessories

B3.
Stainless
Steel Ties

C1.
Wiring
Duct

C2.
Surface
Raceway

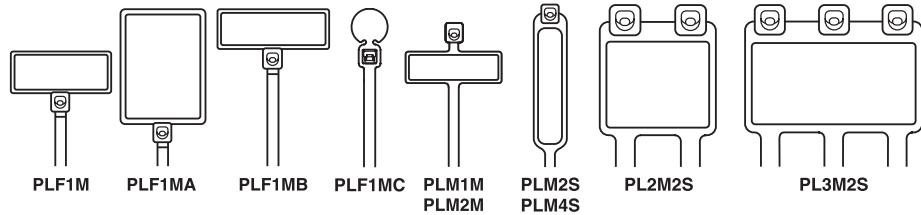
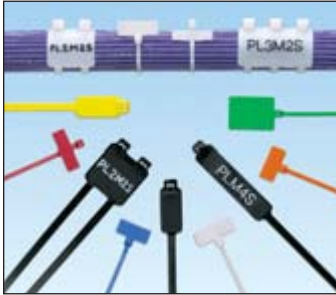

C3.
Abrasion
Protection

C4.
Cable
Management

D1.
Terminals

D2.
Power
Connectors

D3.
Grounding
Connectors

E1.
Labeling
Systems

E2.
Labels

E3.
Pre-Printed
& Write-On
Markers

E4.
Permanent
Identification

E5.
Lockout/
Tagout
& Safety
Solutions

F.
Index

Part Number	Marker Type	Length		Width		Thickness		Marker Write-On Area		Max. Bundle Dia.		Min. Loop Tensile Str.		Recommended Installation Tool	Std. Pkg. Qty.	Std. Ctn. Qty.
		In.	mm	In.	mm	In.	mm	In.	mm	In.	mm	Lbs.	N			

Nylon 6.6

Miniature Cross Section

PLF1M-C	Flag	4.3	109	.098	2.5	.045	1.1	.31 x .75	7.9 x 19.1	.87	22	18	80	GTS, GTSL, GS2B, PTS, PPTS, STS2	100	1000
PLF1MA-C	Flag	5.1	130	.098	2.5	.045	1.1	.76 x 1.04	19.1 x 26.4	.87	22	18	80		100	1000
PLF1MB-C	Flag	4.0	101	.098	2.5	.045	1.1	.31 x .92	7.9 x 23.4	.75	19	18	80		100	1000
PLF1MC-M	Flag	4.3	109	.098	2.5	.045	1.1	.29 x .32	7.4 x 8.0	.87	22	18	80		1000	25000
PLM1M-C	Wrap	3.9	99	.098	2.5	.035	.9	.26 x .95	6.6 x 24.1	.75	19	18	80		100	1000
PLM2M-C	Wrap	8.0	203	.098	2.5	.035	.9	.26 x .95	6.6 x 24.1	2.00	51	18	80		100	1000

Standard Cross Section

PLM2S-C	Wrap	7.4	188	.185	4.7	.052	1.3	.44 x .87	11.1 x 22.1	1.75	45	50	222	GTS, GTSL, GS2B, GTH, GS4H, PTS, PTH, PPTS, STS2, STH2	100	1000
PLM4S-C	Wrap	14.6	371	.185	4.7	.052	1.3	.44 x 2.00	11.1 x 50.8	4.00	102	50	222		100	1000
PL2M2S-L	Wrap	7.4	188	.185	4.7	.052	1.3	.87 x 1.07	22.1 x 27.2	1.75	45	50	222		50	500
PL3M2S-L	Wrap	7.4	188	.185	4.7	.052	1.3	.87 x 1.79	22.1 x 45.5	1.75	45	50	222		50	500

Weather Resistant Nylon 6.6

Miniature Cross Section

PLF1M-C0	Flag	4.3	109	.098	2.5	.045	1.1	.31 x .75	7.9 x 19.1	.87	22	18	80	GTS, GTSL, GS2B, PTS, PPTS, STS2	100	1000
PLF1MA-M0	Flag	5.1	130	.098	2.5	.045	1.1	.76 x 1.04	19.1 x 26.4	.87	22	18	80		1000	10000
PLM1M-C0	Wrap	3.9	99	.098	2.5	.035	.9	.26 x .95	6.6 x 24.1	.75	19	18	80		100	1000
PLM2M-M0	Wrap	8.0	203	.098	2.5	.035	.9	.26 x .95	6.6 x 24.1	2.00	51	18	80		1000	25000

Standard Cross Section

PLM2S-C0	Wrap	7.4	188	.185	4.7	.052	1.3	.44 x .87	11.1 x 22.1	1.75	45	50	222	GTS, GTSL, GS2B, GTH, GS4H, PTS, PTH, PPTS, STS2, STH2	100	1000
PLM4S-D0	Wrap	14.6	371	.185	4.7	.052	1.3	.44 x 2.00	11.1 x 50.8	4.00	102	50	222		500	5000
PL2M2S-L0	Wrap	7.4	188	.185	4.7	.052	1.3	.87 x 1.07	22.1 x 27.2	1.75	45	50	222		50	500
PL3M2S-D0	Wrap	7.4	188	.185	4.7	.052	1.3	.87 x 1.79	22.1 x 45.5	1.75	45	50	222		500	2500

Flame Retardant Nylon 6.6

Miniature Cross Section

PLF1M-M69	Flag	4.3	109	.098	2.5	.045	1.1	.31 x .75	7.9 x 19.1	.87	22	18	80	GTS, GTSL, GS2B, PTS, PPTS, STS2	1000	25000
PLM1M-M69	Wrap	3.9	99	.098	2.5	.035	.9	.26 x .95	6.6 x 24.1	.75	19	18	80		1000	25000

PAN-TY® Cable Ties

Material and Color Chart

Material	Color	PANDUIT Suffix
Nylon 6.6	Natural	✓
Weather Resistant Nylon 6.6	Black	0
Weather Resistant Nylon 6.6 (meets Mil. Spec.)	Black	00
Nylon 6.6	Brown	1
Nylon 6.6	Red	2
Nylon 6.6	Orange	3
Nylon 6.6	Yellow	4Y
Nylon 6.6	Green	5
Nylon 6.6	Blue	6
Nylon 6.6	Purple	7
Nylon 6.6	Gray	8
Nylon 6.6	White	10
Nylon 6.6	Telephone Gray	14
Nylon 6.6	Black	20
Heat Stabilized Nylon 6.6	Black	30

Material	Color	PANDUIT Suffix
Heat Stabilized Nylon 6.6	Natural	39
Nylon 6.6	Fluorescent Orange	53
Nylon 6.6	Fluorescent Yellow	54
Nylon 6.6	Fluorescent Green	55
Nylon 6.6	Fluorescent Pink	59
Flame Retardant Nylon 6.6	Black	60
Flame Retardant Nylon 6.6	Natural (Ivory)	69
PEEK (Polyetheretherketone)	Translucent Brown	71
TEFZEL*	Aqua Blue	76
Metal Detectable	Blue	86
Weather Resistant Polypropylene	Black	100
Polypropylene	Green	109
Nylon 12	Black	120
Heat Stabilized Weather Resistant Nylon 6.6	Black	300
HALAR*	Maroon	702Y

✓ Denotes PANDUIT Natural Nylon 6.6 (no suffix).

*TEFZEL is a registered trademark of E.I. du Pont de Nemours and Company.

*HALAR is a registered trademark of Solvay Solexis, Inc.

Part Number Availability List

Standard Packaging			Bulk Packaging		
Part Number	Natural Nylon 6.6	Material/Color Suffix	Part Number	Natural Nylon 6.6	Material/Color Suffix
PLC1M-S4-C	✓	0	PLC1M-S4-M	✓	0,30
PLC1.5I-S8-C	✓	0	PLC1.5I-S8-M	✓	0,30
PLC2S-S6-C	✓	0	PLC2S-S6-M	✓	0
PLC2S-S10-C	✓	0,14	PLC2S-S10-M	✓	0,20,30
PLC3S-S10-C	✓	0	PLC3S-S10-M	✓	0
PLC4S-S10-C	✓	0	PLC4S-S10-M	✓	0,30
PLC2H-S25-L	✓		PLC2H-S25-TL	✓	0,30
PLC4H-S25-L	✓	0	PLC4H-S25-TL	✓	0,30
PLF1M-C	✓	0	PLF1M-M	✓	0,2,3,4Y,6,10,69
PLF1MA-C	✓	3,4Y	PLF1MA-M	✓	0,2,3,4Y,5,6,10
PLF1MB-C	✓		PLF1MB-M	✓	
			PLF1MC-M		3
PLM1M-C	✓	0	PLM1M-M	✓	0,1,2,3,4Y,5,6,7,8,10,69
PLM2M-C	✓		PLM2M-M	✓	0,4Y,6
PLM2S-C	✓	0,4Y	PLM2S-D	✓	0,2,3,4Y,5,6,8
PLM4S-C	✓		PLM4S-D	✓	0,2,4Y,6

List continues on page B1.36

A.
System
Overview

B1.
Cable
Ties

B2.
Cable
Accessories

B3.
Stainless
Steel Ties

C1.
Wiring
Duct

C2.
Surface
Raceway

C3.
Abrasion
Protection

C4.
Cable
Management

D1.
Terminals

D2.
Power
Connectors

D3.
Grounding
Connectors

E1.
Labeling
Systems

E2.
Labels

E3.
Pre-Printed
& Write-On
Markers

E4.
Permanent
Identification

E5.
Lockout/
Tagout
& Safety
Solutions

F.
Index

A.
System
Overview

PAN-TY® Cable Ties (continued)

B1.
Cable Ties

B2.
Cable
Accessories

B3.
Stainless
Steel Ties

C1.
Wiring
Duct

C2.
Surface
Raceway

C3.
Abrasion
Protection

C4.
Cable
Management

D1.
Terminals

D2.
Power
Connectors

D3.
Grounding
Connectors

E1.
Labeling
Systems

E2.
Labels

E3.
Pre-Printed
& Write-On
Markers

E4.
Permanent
Identification

E5.
Lockout/
Tagout/
& Safety
Solutions

F.
Index

Standard Packaging			Bulk Packaging		
Part Number	Natural Nylon 6.6	Material/Color Suffix	Part Number	Natural Nylon 6.6	Material/Color Suffix
PL2M2S-L	✓	0	PL2M2S-D	✓	0,4Y,10
PL3M2S-L	✓		PL3M2S-D	✓	0,4Y
PLP1.5I-C	✓		PLP1.5I-M	✓	0,30
			PLP1S-M	✓	0,30
			PLP1.5S-M	✓	
PLP2S-C	✓		PLP2S-M	✓	0,30
PLT.6SM-C	✓	0	PLT.6SM-M	✓	0,30
PLT.7M-C	✓		PLT.7M-M	✓	0,30
PLT1M-C	✓	0,00,1,2,3,4Y,5,6,7,8,10,14,30,76,86,702Y	PLT1M-M	✓	0,00,1,2,3,4Y,5,6,7,8,10,14,20,30,53,54,55,59,60,69,76,100,109,300,702Y
			PLT1M-XMR	✓	0,1,2,3,4Y,5,6,7,8,10,30
PLT1.5M-C	✓	0	PLT1.5M-M	✓	0,00,1,2,3,4Y,5,6,7,8,10,14,20,30
			PLT1.5M-XMR	✓	0,00,30
PLT2M-C	✓	0	PLT2M-M	✓	0,1,2,3,4Y,5,6,7,8,10,20,30,69
PLT1.5I-C	✓	0,1,2,3,4Y,5,6,7,8,10,20,30	PLT1.5I-M	✓	0,00,1,2,3,4Y,5,6,7,8,10,20,30,69,100,109,120,300
PLT2I-C	✓	0,14,30,76,86	PLT2I-M	✓	0,00,1,2,3,4Y,5,6,7,8,10,14,20,30,53,54,55,59,69,76,300
PLT2.5I-C	✓	0	PLT2.5I-M	✓	0,20
PLT3I-C	✓	0,14	PLT3I-M	✓	0,2,3,4Y,5,6,8,10,14,20,30
PLT4I-C	✓	0,14	PLT4I-M	✓	0,2,5,6,14,20,30
PLT1S-C	✓	0	PLT1S-M	✓	0,30,38,300
PLT1.5S-C	✓	0	PLT1.5S-M	✓	0,30
PLT2S-C	✓	0,00,1,2,3,4Y,5,6,7,8,10,20,30,71,76,86,702Y	PLT2S-M	✓	0,00,1,2,3,4Y,5,6,7,8,10,20,30,38,39,53,54,55,59,60,69,71,76,100,109,120,300,702Y
			PLT2S-VMR	✓	0,30
PLT2.5S-C	✓	0	PLT2.5S-M	✓	0,30
PLT3S-C	✓	0,00,2,20,30,76,86,702Y	PLT3S-M	✓	0,00,1,2,3,4Y,5,6,7,8,10,20,30,53,54,55,59,76,100,109,702Y
PLT4S-C	✓	0,00,2,3,4Y,5,6,8,20,30,76,86	PLT4S-M	✓	0,00,1,2,3,4Y,5,6,7,8,10,14,20,30,69,76,100,109,120,300
PLT4.5S-C	✓	0	PLT4.5S-M	✓	0
PLT5S-C	✓	0	PLT5S-M	✓	0,2,3,4Y,5,6,8,30
PLT6LH-L	✓	0	PLT6LH-C	✓	0
PLT7LH-L	✓	0	PLT7LH-C	✓	0,30
PLT8LH-L	✓	0	PLT8LH-C	✓	0,120
PLT8LH-Q		0			
PLT9LH-L	✓	0	PLT9LH-C	✓	0,30
PLT10LH-L	✓		PLT10LH-C	✓	
PLT2H-L	✓	0	PLT2H-TL	✓	0,2,4Y,6,30,100,109,300
PLT2.5H-L	✓	0	PLT2.5H-TL	✓	0
PLT3H-L	✓	0,76,86	PLT3H-TL	✓	0,30,76,100,109
PLT4H-L	✓	0,00,76,86	PLT4H-TL	✓	0,00,1,2,3,4Y,5,6,10,20,30,69,76,100,109,120,300
PLT4H-C	✓	0			
PLT5H-L	✓	0	PLT5H-C	✓	0,30
PLT6H-L	✓	0	PLT6H-C	✓	0,30
PLT8H-L	✓	0	PLT8H-C	✓	0,00,30
PLT8H-L	✓	0			
PLT13H-Q	✓	0	PLT13H-C	✓	0,3

Standard Packaging			Bulk Packaging		
Part Number	Natural Nylon 6.6	Material/Color Suffix	Part Number	Natural Nylon 6.6	Material/Color Suffix
PLT2EH-Q		0	PLT2EH-C	✓	0
			PLT3EH-NB-C		0
PLT5EH-Q	✓	0	PLT5EH-C	✓	0
			PLT5EH-NB-C		0
PLT6EH-Q	✓	0	PLT6EH-C	✓	0
			PLT6EH-NB-C		0
PLT8EH-Q		0	PLT8EH-C	✓	0
PLT10EH-Q		0	PLT10EH-C	✓	0
PLT12EH-Q		0	PLT12EH-C	✓	0
			PLUP40S-D		30
			PLUP40SE-D	✓	30
PLWP1M-C	✓		PLWP1M-D	✓	0,30
PLWP1.5I-C	✓		PLWP1.5I-D	✓	30
PLWP1S-C	✓	0	PLWP1S-D	✓	0,20,30
			PLWP1SA-D	✓	
			PLWP1SB-D	✓	
			PLWP1.5S-D	✓	30
			PLWP1.5SA-D	✓	
PLWP2S-C	✓	0	PLWP2S-D	✓	0,30
			PLWP2SA-D	✓	
			PLWP2SB-D	✓	
			PLWP2H-TL	✓	0,30
			PLWP3H-TL	✓	0
			PLWP30SC-D		30
			PLWP40SC-D		30
			PLWP40SD-D		30
			PLWP50SC-D		30
			PLWP50SE-D		30
			PRLWP30S-D		30
			PRLWP50S-D		30
PRT1S-C	✓	0	PRT1S-M	✓	0
PRT1.5S-C	✓	0	PRT1.5S-M	✓	0,30
PRT2S-C	✓	0	PRT2S-M	✓	0,2,3,4Y,6,7
PRT3S-C	✓	0	PRT3S-M	✓	0
PRT4S-C	✓	0	PRT4S-M	✓	0,2,3,4Y,6
PRT2H-L	✓	0	PRT2H-TL	✓	0
PRT3H-L	✓	0	PRT3H-TL	✓	0
PRT4H-L	✓	0	PRT4H-TL	✓	0
PRT2EH-Q		0	PRT2EH-C	✓	0,100
PRT5EH-Q	✓	0	PRT5EH-C	✓	0,100
PRT6EH-Q	✓	0	PRT6EH-C	✓	0,100
PRT8EH-Q		0	PRT8EH-C	✓	0,100
PRT10EH-Q		0	PRT10EH-C	✓	0
PRT12EH-Q		0	PRT12EH-C	✓	0
PRWP1S-C	✓		PRWP1S-D	✓	0
			PRWP1SA-D	✓	
			PRWP1SB-D	✓	
			PRWP1.5S-D	✓	0,20,30
			PRWP2S-D	✓	0
			PRWP2H-TL	✓	

A.
System
Overview

B1.
Cable Ties

B2.
Cable
Accessories

B3.
Stainless
Steel Ties

C1.
Wiring
Duct

C2.
Surface
Raceway

C3.
Abrasion
Protection

C4.
Cable
Management

D1.
Terminals

D2.
Power
Connectors

D3.
Grounding
Connectors

E1.
Labeling
Systems

E2.
Labels

E3.
Pre-Printed
& Write-On
Markers

E4.
Permanent
Identification

E5.
Lockout/
Tagout
& Safety
Solutions

F.
Index

A.
System
Overview

Features and Benefits – SUPER-GRIP® Cable Ties

One-piece design with a thin, wide strap body for improved flexibility.

B1.
Cable Ties

Dome shaped head and smooth, round strap body protect the cable insulation

B2.
Cable
Accessories

B3.
Stainless
Steel Ties

C1.
Wiring
Duct

C2.
Surface
Raceway

C3.
Abrasion
Protection

C4.
Cable
Management

D1.
Terminals

D2.
Power
Connectors

D3.
Grounding
Connectors

E1.
Labeling
Systems

E2.
Labels

E3.
Pre-Printed
& Write-On
Markers

E4.
Permanent
Identification

E5.
Lockout/
Tagout/
& Safety
Solutions

F.
Index



One-piece locking wedge provides consistent, reliable performance

Strong locking wedge improves strength and allows for rough handling



High loop tensile strength exceeds industry standards

Thin, wide strap body provides increased flexibility while maintaining loop tensile strength

Thin, flared neck tolerates rough installation practices and improves small bundle performance

Curved, tapered tip threads easily and installs faster

Aggressive grips allow temporary threading of tie before the strap teeth are engaged



Cable tie tools speed installation and reduce total installed cost. See pages B1.107 – B1.112.



Cable tie accessories are used to speed and simplify the mounting of wires, cables, and tubing. See pages B2.5, B2.7, B2.12, B2.14, B2.20.

Selection Guide – SUPER-GRIP® Cable Ties



Material, Color (Suffix)	Style/Function	Part Number Prefix	Catalog Page
Nylon 6.6, Natural (No Suffix)	Locking Ties/Bundle	SG	B1.40
Weather Resistant Nylon 6.6, Black (0)	Locking Ties/Bundle	SG	B1.41
Heat Stabilized Nylon 6.6, Black (30)	Locking Ties/Bundle	SG	B1.41

Part Number System for SUPER-GRIP® Cable Ties

SG

Type

SG = Locking Tie

200

Length

Approx. Length (mm)

S

Cross Section

M = Miniature
I = Intermediate
S = Standard
LH = Light-Heavy
H = Heavy

—

C

Package Size

L = 50
C = 100
TL = 250
M = 1000

T

Material/Color

See Page B1.42

A. System Overview

B1. Cable Ties

B2. Cable Accessories

B3. Stainless Steel Ties

C1. Wiring Duct

C2. Surface Raceway

C3. Abrasion Protection

C4. Cable Management

D1. Terminals

D2. Power Connectors

D3. Grounding Connectors

E1. Labeling Systems

E2. Labels

E3. Pre-Printed & Write-On Markers

E4. Permanent Identification

E5. Lockout/Tagout & Safety Solutions

F. Index

A.
System
Overview



SUPER-GRIP® Cable Ties – Nylon 6.6

B1.
Cable Ties

- For indoor use
- Designed to grip the bundle tightly to resist lateral movement of the tie once installed
- High strength allows the tie to withstand rough installation practices that occur in MRO and construction environments

- Thin, wide strap body provides flexibility enabling it to conform to bundle while maintaining tensile strength
- Curved tip is easy to pick up from flat surfaces and allows faster initial threading to speed installation
- Complementary mounts available, see pages B2.5, B2.7, B2.12, B2.14 and B2.20

B2.
Cable
Accessories

B3.
Stainless
Steel Ties

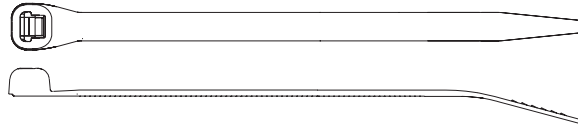

C1.
Wiring
Duct

C2.
Surface
Raceway

C3.
Abrasion
Protection

C4.
Cable
Management

D1.
Terminals

D2.
Power
Connectors

D3.
Grounding
Connectors

E1.
Labeling
Systems

E2.
Labels

E3.
Pre-Printed
& Write-On
Markers

E4.
Permanent
Identification

E5.
Lockout/
Tagout
& Safety
Solutions

F.
Index

Part Number	Length		Width		Thickness		Max. Bundle Dia.		Min. Loop Tensile Strength		Recommended Installation Tool	Std. Pkg. Qty.	Std. Ctn. Qty.
	In.	mm	In.	mm	In.	mm	In.	mm	Lbs.	N			
Miniature Cross Section													
SG100M-C	4.2	106	.118	3.0	.038	1.0	.90	23	18	80	GTS, GTSL, GS2B, PTS, PPTS, STS2	100	1000
Intermediate Cross Section													
SG150I-C	6.2	157	.168	4.3	.040	1.0	1.50	38	40	178	GTS, GTSL, GS2B, PTS, PPTS, STS2	100	1000
Standard Cross Section													
SG200S-C	8.3	211	.225	5.7	.046	1.2	2.00	51	50	222	GTS, GTSL, GS2B, GTH, GS4H, PTS, PTH, PPTS, STS2, STH2	100	1000
SG250S-C	10.4	264	.225	5.7	.050	1.3	2.60	66	75	334		100	1000
SG300S-C	12.4	315	.225	5.7	.050	1.3	3.20	81	75	334		100	1000
SG370S-C	15.3	389	.225	5.7	.052	1.3	4.20	107	75	334		100	1000
Light-Heavy Cross Section													
SG350LH-L	15.3	389	.330	8.4	.064	1.6	4.13	105	120	534	GTH, GS4H, GS4EH, PTH, STH2, ST3EH	50	500
Heavy Cross Section													
SG450H-L	18.6	471	.380	9.7	.068	1.7	5.20	132	175	778	GTH, GS4H, GS4EH, PTH, STH2, ST3EH	50	500



SUPER-GRIP® Cable Ties – Weather Resistant and Heat Stabilized Nylon 6.6

- Weather resistant material has greater resistance to damage caused by ultraviolet light – indoor or outdoor use
- Heat stabilized material for high temperature applications up to 239°F (115°C) – indoor use
- Designed to grip the bundle tightly to resist lateral movement of the tie once installed

- High strength allows the tie to withstand rough installation practices that occur in MRO and construction environments
- Thin, wide strap body provides flexibility enabling it to conform to bundle while maintaining tensile strength
- Curved tip is easy to pick up from flat surfaces and allows faster initial threading to speed installation
- Complementary mounts available, see pages B2.5, B2.7, B2.12, B2.14 and B2.20

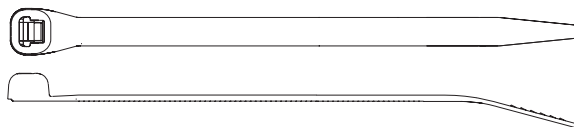

Part Number	Length		Width		Thickness		Max. Bundle Dia.		Min. Loop Tensile Strength		Recommended Installation Tool	Std. Pkg. Qty.	Std. Ctn. Qty.
	In.	mm	In.	mm	In.	mm	In.	mm	Lbs.	N			

Weather Resistant Nylon 6.6

Miniature Cross Section

SG100M-C0	4.2	106	.118	3.0	.038	1.0	.90	23	18	80	GTS, GTSL, GS2B, PTS, PPTS, STS2	100	1000
------------------	-----	-----	------	-----	------	-----	-----	----	----	----	----------------------------------	-----	------

Intermediate Cross Section

SG150I-C0	6.2	157	.168	4.3	.040	1.0	1.50	38	40	178	GTS, GTSL, GS2B, PTS, PPTS, STS2	100	1000
------------------	-----	-----	------	-----	------	-----	------	----	----	-----	----------------------------------	-----	------

Standard Cross Section

SG200S-C0	8.3	211	.225	5.7	.046	1.2	2.00	51	50	222	GTS, GTSL, GS2B, GTH, GS4H, PTS, PTH, PPTS, STS2, STH2	100	1000
SG250S-C0	10.4	264	.225	5.7	.050	1.3	2.60	66	75	334		100	1000
SG300S-C0	12.4	315	.225	5.7	.050	1.3	3.20	81	75	334		100	1000
SG370S-C0	15.3	389	.225	5.7	.052	1.3	4.20	107	75	334		100	1000

Light-Heavy Cross Section

SG350LH-L0	15.3	389	.330	8.4	.064	1.6	4.13	105	120	534	GTH, GS4H, GS4EH, PTH, STH2, ST3EH	50	500
-------------------	------	-----	------	-----	------	-----	------	-----	-----	-----	------------------------------------	----	-----

Heavy Cross Section

SG450H-L0	18.6	471	.380	9.7	.068	1.7	5.20	132	175	778	GTH, GS4H, GS4EH, PTH, STH2, ST3EH	50	500
------------------	------	-----	------	-----	------	-----	------	-----	-----	-----	------------------------------------	----	-----

Heat Stabilized Nylon 6.6

Standard Cross Section

SG200S-M30	8.3	211	.225	5.7	.046	1.2	2.00	51	50	222	GTS, GTSL, GS2B, GTH, GS4H, PTS, PTH, PPTS, STS2, STH2	1000	10000
SG300S-M30	12.4	315	.225	5.7	.050	1.3	3.20	81	70	311		1000	10000

Light-Heavy Cross Section

SG350LH-TL30	15.3	389	.330	8.4	.064	1.6	4.13	105	120	534	GTH, GS4H, GS4EH, PTH, STH2, ST3EH	250	2500
---------------------	------	-----	------	-----	------	-----	------	-----	-----	-----	------------------------------------	-----	------

Note: UL Listed and CSA Certified except SG450H-L0 and heat stabilized material (30).

A.
System
Overview

B1.
Cable
Ties

B2.
Cable
Accessories

B3.
Stainless
Steel
Ties

C1.
Wiring
Duct

C2.
Surface
Raceway

C3.
Abrasion
Protection

C4.
Cable
Management

D1.
Terminals

D2.
Power
Connectors

D3.
Grounding
Connectors

E1.
Labeling
Systems

E2.
Labels

E3.
Pre-Printed
& Write-On
Markers

E4.
Permanent
Identification

E5.
Lockout/
Tagout
& Safety
Solutions

F.
Index

A.
System
Overview

SUPER-GRIP® Cable Ties and Mounts

B1.
Cable Ties

Material and Color Chart

Material	Color	PANDUIT Suffix
Nylon 6.6	Natural	✓
Weather Resistant Nylon 6.6	Black	0
Heat Stabilized Nylon 6.6	Black	30

✓ Denotes PANDUIT Natural Nylon 6.6 (no suffix).

C1.
Wiring
Duct

Part Number Availability List

	Standard Packaging			Bulk Packaging		
	Part Number	Natural Nylon 6.6	Material/Color Suffix	Part Number	Natural Nylon 6.6	Material/Color Suffix
C2. Surface Raceway	SG100M-C	✓	0	SG100M-M	✓	0
	SG150I-C	✓	0	SG150I-M	✓	0
C3. Abrasion Protection	SG200S-C	✓	0	SG200S-M	✓	0,30
	SG250S-C	✓	0			
C4. Cable Management	SG300S-C	✓	0	SG300S-M	✓	0,30
	SG370S-C	✓	0	SG370S-M	✓	0
	SG350LH-L	✓	0	SG350LH-TL	✓	0,30
	SG450H-L	✓	0	SG450H-C	✓	0

D1.
Terminals

D2.
Power
Connectors

D3.
Grounding
Connectors

E1.
Labeling
Systems

E2.
Labels

E3.
Pre-Printed
& Write-On
Markers

E4.
Permanent
Identification

E5.
Lockout/
Tagout
& Safety
Solutions

F.
Index

Features and Benefits – *DOME-TOP®* Barb Ty Cable Ties

Two-piece design incorporates a stainless steel locking barb in a nylon cable tie.

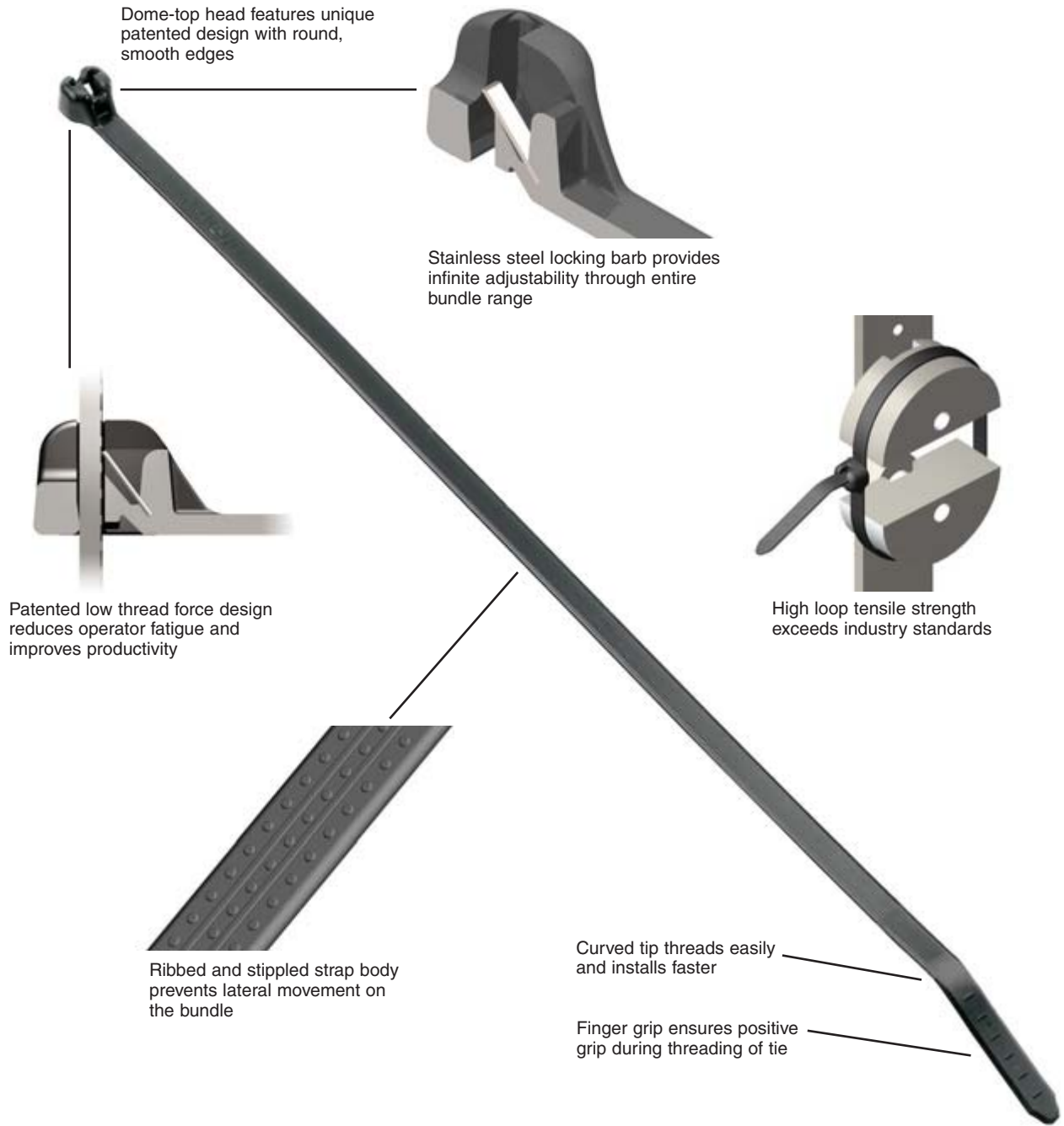

Cable tie tools speed installation and reduce total installed cost. See pages B1.107 – B1.112.



Cable tie accessories are used to speed and simplify the mounting of wires, cables, and tubing. See pages B2.1 – B2.29.

A. System Overview

B1. Cable Ties

B2. Cable Accessories

B3. Stainless Steel Ties

C1. Wiring Duct

C2. Surface Raceway

C3. Abrasion Protection

C4. Cable Management

D1. Terminals

D2. Power Connectors

D3. Grounding Connectors

E1. Labeling Systems

E2. Labels

E3. Pre-Printed & Write-On Markers

E4. Permanent Identification

E5. Lockout/Tagout & Safety Solutions

F. Index

A.
System
Overview

Selection Guide – *DOME-TOP*® Barb Ty and *DURA-TY*™ Cable Ties

B1.
Cable Ties



B2.
Cable
Accessories

B3.
Stainless
Steel Ties

C1.
Wiring
Duct

C2.
Surface
Raceway

C3.
Abrasion
Protection

C4.
Cable
Management

D1.
Terminals

D2.
Power
Connectors

D3.
Grounding
Connectors

E1.
Labeling
Systems

E2.
Labels

E3.
Pre-Printed
& Write-On
Markers

E4.
Permanent
Identification

E5.
Lockout/
Tagout/
& Safety
Solutions

F.
Index

Material, Color (Suffix)	Style/Function	Part Number Prefix	Catalog Page
Nylon 6.6, Natural (No Suffix)	Locking Ties/Bundle	BT	B1.45
	Clamp Ties/Mount	BC	B1.48
	Push Mount Ties/Mount	BW	B1.50
	Marker Ties/Identify	BF, BM, B2M, B3M, B4M	B1.52
DOME-TOP ® Barb Ty Cable Ties Weather Resistant Nylon 6.6, Black (0)	Locking Ties/Bundle	BT	B1.46
	Clamp Ties/Mount	BC	B1.49
	Push Mount Ties/Mount	BW, BP	B1.50,51
	Marker Ties/Identify	BF, BM, B2M, B3M, B4M	B1.52
Heat Stabilized Nylon 6.6, Black (30)	Locking Ties/Bundle	BT	B1.47
	Clamp Ties/Mount	BC	B1.49
Heat Stabilized Nylon 6.6, Natural (39)	Locking Ties/Bundle	BT	B1.47
DURA-TY ™ Cable Ties, Strapping, and Kits Weather Resistant Acetal, Black	Locking Ties/Bundle	DT	B1.53

Part Number System for *DOME-TOP*® Barb Ty and *DURA-TY*™ Cable Ties

BT	2	S	—	C	—
Type	Size	Cross Section	Screw Hole Size	Package Size	Material/Color
BT = Locking Tie BC = Clamp Tie BF = Flag Tie BM = Marker Tie BP = Push Mount Tie BW = Wing Push Mount Tie DT = Locking Tie	Approx. Maximum Bundle Dia. (In.)	M = Miniature I = Intermediate S = Standard LH = Light-Heavy H = Heavy EH = Extra-Heavy	(Clamp Ties Only) -S4 = #4 (M2.5) -S6 = #6 (M3) -S8 = #8 (M4) -S10 = #10 (M5) -S25 = 1/4 (M6)	Q = 25 L = 50 C = 100 TL = 250 D = 500 M = 1000 LR = 50' Reel	See Page B1.54



DOME-TOP® Barb Ty Cable Ties – Nylon 6.6

- For indoor use
- Dome-top head features unique patented design with round, smooth edges
- Stainless steel locking barb provides consistent performance, reliability, and infinite adjustability through entire bundle range

- High strength and low thread force
- A variety of materials and colors are available for specific applications
- Curved tip is easy to pick up from flat surfaces and allows faster initial threading to speed installation

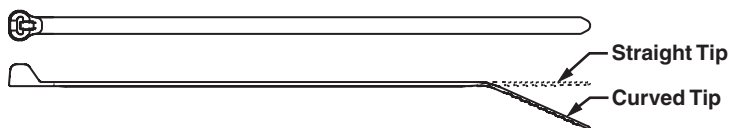

Part Number	Length		Width		Thickness		Max. Bundle Dia.		Min. Loop Tensile Str.		Recommended Installation Tool	Std. Pkg. Qty.	Std. Ctn. Qty.
	In.	mm	In.	mm	In.	mm	In.	mm	Lbs.	N			
Miniature Cross Section													
BT1M-C	4.0	102	.095	2.4	.036	.9	.90	23	18	80	GTS, GTSL, GS2B, PTS, PPTS, STS2	100	1000
BT1.5M-C	6.3	160	.095	2.4	.046	1.2	1.50	38	18	80		100	1000
BT2M-C	7.9	201	.095	2.4	.046	1.2	2.00	51	18	80		100	1000
BT4M-C	14.2	361	.095	2.4	.046	1.2	4.00	102	18	80		100	1000
Intermediate Cross Section													
BT1.5I-C	6.1	155	.141	3.6	.041	1.0	1.50	38	40	178	GTS, GTSL, GS2B, PTS, PPTS, STS2	100	1000
BT2I-C	8.0	203	.141	3.6	.041	1.0	2.00	51	40	178		100	1000
BT3I-C	11.3	287	.141	3.6	.049	1.2	3.00	76	40	178		100	1000
BT4I-C	14.3	363	.141	3.6	.049	1.2	4.00	102	40	178		100	1000
Standard Cross Section													
BT2S-C	8.0	203	.185	4.7	.045	1.1	2.00	51	50	222	GTS, GTSL, GS2B, GTH, GS4H, PTS, PTH, PPTS, STS2, STH2	100	1000
BT3S-C	12.0	305	.185	4.7	.052	1.3	3.00	76	50	222		100	1000
BT4S-C	15.1	384	.185	4.7	.052	1.3	4.00	102	50	222		100	1000
Light-Heavy Cross Section (Straight Tip)													
BT2LH-L	8.7	221	.275	7.0	.065	1.7	2.00	51	120	534	GTH, GS4H, GS4EH, PTH, STH2, ST3EH	50	500
BT3LH-L	11.8	300	.275	7.0	.065	1.7	3.00	76	120	534		50	500
BT4LH-L	14.9	378	.275	7.0	.065	1.7	4.00	102	120	534		50	500
BT5LH-L	18.1	460	.275	7.0	.065	1.7	5.00	127	120	534		50	500
BT6LH-L	21.2	538	.275	7.0	.065	1.7	6.00	152	120	534		50	500
BT7LH-L	24.4	620	.275	7.0	.065	1.7	7.00	178	120	534		50	500
BT8LH-L	27.5	699	.275	7.0	.065	1.7	8.00	203	120	534		50	500
BT9LH-L	30.7	780	.275	7.0	.065	1.7	9.00	229	120	534		50	500

A. System Overview

B1. Cable Ties

B2. Cable Accessories

B3. Stainless Steel Ties

C1. Wiring Duct

C2. Surface Raceway

C3. Abrasion Protection

C4. Cable Management

D1. Terminals

D2. Power Connectors

D3. Grounding Connectors

E1. Labeling Systems

E2. Labels

E3. Pre-Printed & Write-On Markers

E4. Permanent Identification

E5. Lockout/Tagout & Safety Solutions

F. Index

A. System Overview



DOME-TOP® Barb Ty Cable Ties – Weather Resistant Nylon 6.6

B1. Cable Ties

- Greater resistance to damage caused by ultraviolet light – indoor or outdoor use
- Dome-top head features unique patented design with round, smooth edges

- Stainless steel locking barb provides consistent performance, reliability, and infinite adjustability through entire bundle range
- High strength and low thread force
- Curved tip is easy to pick up from flat surfaces and allows faster initial threading to speed installation

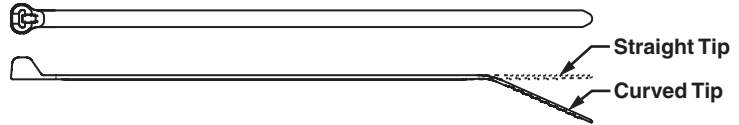

B3. Stainless Steel Ties

C1. Wiring Duct

C2. Surface Raceway

Part Number	Length		Width		Thickness		Max. Bundle Dia.		Min. Loop Tensile Str.		Recommended Installation Tool	Std. Pkg. Qty.	Std. Ctn. Qty.
	In.	mm	In.	mm	In.	mm	In.	mm	Lbs.	N			

Miniature Cross Section

BT1M-C0	4.0	102	.095	2.4	.036	.9	.90	23	18	80	GTS, GTSL, GS2B, PTS, PPTS, STS2	100	1000
BT1.5M-C0	6.3	160	.095	2.4	.046	1.2	1.50	38	18	80		100	1000
BT2M-C0	7.9	201	.095	2.4	.046	1.2	2.00	51	18	80		100	1000
BT4M-C0	14.2	361	.095	2.4	.046	1.2	4.00	102	18	80		100	1000

Intermediate Cross Section

BT1.5I-C0	6.1	155	.141	3.6	.041	1.0	1.50	38	40	178	GTS, GTSL, GS2B, PTS, PPTS, STS2	100	1000
BT2I-C0	8.0	203	.141	3.6	.041	1.0	2.00	51	40	178		100	1000
BT3I-C0	11.3	287	.141	3.6	.049	1.2	3.00	76	40	178		100	1000
BT4I-C0	14.3	363	.141	3.6	.049	1.2	4.00	102	40	178		100	1000

Standard Cross Section

BT2S-C0	8.0	203	.185	4.7	.045	1.1	2.00	51	50	222	GTS, GTSL, GS2B, GTH, GS4H, PTS, PTH, PPTS, STS2, STH2	100	1000
BT3S-C0	12.0	305	.185	4.7	.052	1.3	3.00	76	50	222		100	1000
BT4S-C0	15.1	384	.185	4.7	.052	1.3	4.00	102	50	222		100	1000

Light-Heavy Cross Section (Straight Tip)

BT2LH-L0	8.7	221	.275	7.0	.065	1.7	2.00	51	120	534	GTH, GS4H, GS4EH, PTH, STH2, ST3EH	50	500
BT3LH-L0	11.8	300	.275	7.0	.065	1.7	3.00	76	120	534		50	500
BT4LH-L0	14.9	378	.275	7.0	.065	1.7	4.00	102	120	534		50	500
BT5LH-L0	18.1	460	.275	7.0	.065	1.7	5.00	127	120	534		50	500
BT6LH-L0	21.2	538	.275	7.0	.065	1.7	6.00	152	120	534		50	500
BT7LH-L0	24.4	620	.275	7.0	.065	1.7	7.00	178	120	534		50	500
BT8LH-L0	27.5	699	.275	7.0	.065	1.7	8.00	203	120	534		50	500
BT9LH-L0	30.7	780	.275	7.0	.065	1.7	9.00	229	120	534		50	500

Note: UL Recognized, UL Listed, and CSA Certified, except LH cross section.

E3. Pre-Printed & Write-On Markers

E4. Permanent Identification

E5. Lockout/Tagout & Safety Solutions

F. Index



DOME-TOP® Barb Ty Cable Ties – Heat Stabilized Nylon 6.6

- For high temperature applications up to 239°F (115°C) – indoor use
- Dome-top head features unique patented design with round, smooth edges

- Stainless steel locking barb provides consistent performance, reliability, and infinite adjustability through entire bundle range
- Curved tip is easy to pick up from flat surfaces and allows faster initial threading to speed installation



BT2S-M30

BT2S-M39

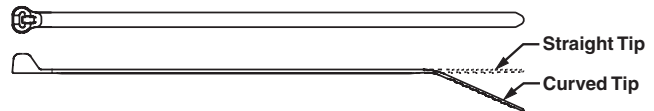

Part Number	Length		Width		Thickness		Max. Bundle Dia.		Min. Loop Tensile Str.		Recommended Installation Tool	Std. Pkg. Qty.	Std. Ctn. Qty.
	In.	mm	In.	mm	In.	mm	In.	mm	Lbs.	N			

Heat Stabilized Nylon 6.6 – Black

Miniature Cross Section

BT1M-C30	4.0	102	.095	2.4	.036	.9	.90	23	18	80	GTS, GTSL, GS2B, PTS, PPTS, STS2	100	1000
BT1.5M-M30	6.3	160	.095	2.4	.046	1.2	1.50	38	18	80		1000	50000
BT2M-M30	7.9	201	.095	2.4	.046	1.2	2.00	51	18	80		1000	25000

Intermediate Cross Section

BT1.5I-M30	6.1	155	.141	3.6	.041	1.0	1.50	38	40	178	GTS, GTSL, GS2B, PTS, PPTS, STS2	1000	25000
BT2I-M30	8.0	203	.141	3.6	.041	1.0	2.00	51	40	178		1000	25000
BT3I-M30	11.3	287	.141	3.6	.049	1.2	3.00	76	40	178		1000	10000

Standard Cross Section

BT2S-M30	8.0	203	.185	4.7	.045	1.1	2.00	51	50	222	GTS, GTSL, GS2B, GTS, GS4H, PTS, PTH, PPTS, STS2, STH2	1000	10000
BT3S-M30	12.0	305	.185	4.7	.052	1.3	3.00	76	50	222		1000	10000
BT4S-M30	15.1	384	.185	4.7	.052	1.3	4.00	102	50	222		1000	5000

Light-Heavy Cross Section (Straight Tip)

BT4LH-TL30	14.9	378	.275	7.0	.065	1.7	4.00	102	120	534	GTH, GS4H, GS4EH, PTH, STH2, ST3EH	250	2500
------------	------	-----	------	-----	------	-----	------	-----	-----	-----	------------------------------------	-----	------

Heat Stabilized Nylon 6.6 – Natural

Miniature Cross Section

BT1M-M39	4.0	102	.095	2.4	.036	.9	.90	23	18	80	GTS, GTSL, GS2B, PTS, PPTS, STS2	1000	50000
----------	-----	-----	------	-----	------	----	-----	----	----	----	----------------------------------	------	-------

Intermediate Cross Section

BT1.5I-M39	6.1	155	.141	3.6	.041	1.0	1.50	38	40	178	GTS, GTSL, GS2B, PTS, PPTS, STS2	1000	25000
------------	-----	-----	------	-----	------	-----	------	----	----	-----	----------------------------------	------	-------

Standard Cross Section

BT2S-M39	8.0	203	.185	4.7	.045	1.1	2.00	51	50	222	GTS, GTSL, GS2B, GTS, GS4H, PTS, PTH, PPTS, STS2, STH2	1000	10000
BT3S-M39	12.0	305	.185	4.7	.052	1.3	3.00	76	50	222		1000	10000
BT4S-M39	15.1	384	.185	4.7	.052	1.3	4.00	102	50	222		1000	5000

Light-Heavy Cross Section (Straight Tip)

BT4LH-TL39	14.9	378	.275	7.0	.065	1.7	4.00	102	120	534	GTH, GS4H, GS4EH, PTH, STH2, ST3EH	250	2500
------------	------	-----	------	-----	------	-----	------	-----	-----	-----	------------------------------------	-----	------

A. System Overview

B1. Cable Ties

B2. Cable Accessories

B3. Stainless Steel Ties

C1. Wiring Duct

C2. Surface Raceway

C3. Abrasion Protection

C4. Cable Management

D1. Terminals

D2. Power Connectors

D3. Grounding Connectors

E1. Labeling Systems

E2. Labels

E3. Pre-Printed & Write-On Markers

E4. Permanent Identification

E5. Lockout/Tagout & Safety Solutions

F. Index

A.
System
Overview

UL **UL** **SP** **DOME-TOP® Barb Ty Clamp Ties – Nylon 6.6**

B1.
Cable Ties

- For indoor use
- Used to secure a cable bundle to another surface such as a control panel, communication rack, wall or ceiling
- Design allows for bundling before or after screwing clamp in place

- Stainless steel locking barb provides consistent performance, reliability, and infinite adjustability through entire bundle range
- Curved tip is easy to pick up from flat surfaces and allows faster initial threading to speed installation

B2.
Cable
Accessories

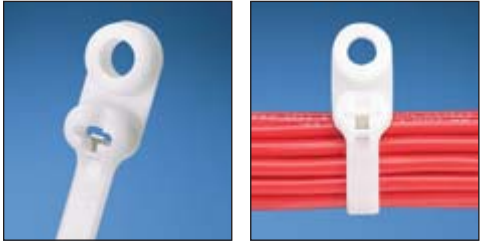

B3.
Stainless
Steel Ties

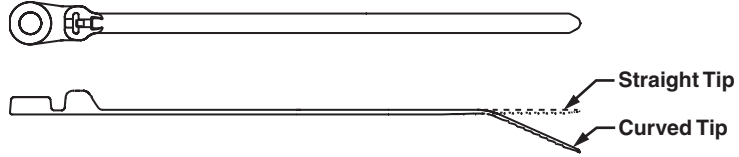

C1.
Wiring
Duct



C2.
Surface
Raceway

Part Number	Length		Width		Thickness		Nominal Hole Dia.		Screw Size	Metric Screw Size	Max. Bundle Dia.		Min. Loop Tensile Str.		Recommended Installation Tool	Std. Pkg. Qty.	Std. Ctn. Qty.
	In.	mm	In.	mm	In.	mm	In.	mm			In.	mm	Lbs.	N			

C3.
Abrasion
Protection

Miniature Cross Section

BC1M-S4-M	4.6	117	.095	2.4	.046	1.2	.122	3.1	#4	M2.5	.90	23	18	80	GTS, GTSL, GS2B, PTS, PPTS, STS2	1000	50000
BC2M-S4-M	8.3	211	.095	2.4	.046	1.2	.122	3.1	#4	M2.5	2.00	51	18	80		1000	25000

C4.
Cable
Management

Intermediate Cross Section

BC1.5I-S8-M	6.6	168	.141	3.6	.041	1.0	.174	4.4	#8	M4	1.50	38	40	178	GTS, GTSL, GS2B, PTS, PPTS, STS2	1000	25000
--------------------	-----	-----	------	-----	------	-----	------	-----	----	----	------	----	----	-----	----------------------------------	------	-------

D1.
Terminals

Standard Cross Section

BC2S-S10-C	8.5	216	.185	4.7	.052	1.3	.200	5.1	#10	M5	2.00	51	50	222	GTS, GTSL, GS2B, GTH, GS4H, PTS, PTH, PPTS, STS2, STH2	100	1000
BC3S-S10-D	12.5	318	.185	4.7	.052	1.3	.200	5.1	#10	M5	3.00	76	50	222		500	5000
BC4S-S10-C	15.6	396	.185	4.7	.052	1.3	.200	5.1	#10	M5	4.00	102	50	222		100	1000

D2.
Power
Connectors

Light-Heavy Cross Section (Straight Tip)

BC4LH-S25-L	15.5	394	.275	7.0	.065	1.7	.260	6.6	1/4	M6	4.00	102	120	534	GTH, GS4H, GS4EH, PTH, STH2, ST3EH	50	500
--------------------	------	-----	------	-----	------	-----	------	-----	-----	----	------	-----	-----	-----	------------------------------------	----	-----

D3.
Grounding
Connectors

E1.
Labeling
Systems

E2.
Labels

E3.
Pre-Printed
& Write-On
Markers

E4.
Permanent
Identification

E5.
Lockout/
Tagout/
& Safety
Solutions

F.
Index



DOME-TOP® Barb Ty Clamp Ties – Weather Resistant and Heat Stabilized Nylon 6.6

- Weather Resistant material has greater resistance to damage caused by ultraviolet light – indoor or outdoor use
- Heat stabilized material for high temperature applications up to 239°F (115°C) – indoor use
- Used to secure a cable bundle to another surface such as a control panel, communication rack, wall or ceiling
- Design allows for bundling before or after screwing clamp in place
- Stainless steel locking barb provides consistent performance, reliability, and infinite adjustability through entire bundle range
- Curved tip is easy to pick up from flat surfaces and allows faster initial threading to speed installation

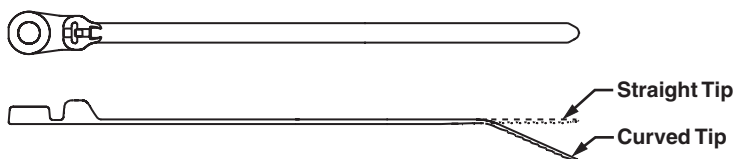

Part Number	Length		Width		Thickness		Nominal Hole Dia.		Screw Size	Metric Screw Size	Max. Bundle Dia.		Min. Loop Tensile Str.		Recommended Installation Tool	Std. Pkg. Qty.	Std. Ctn. Qty.
	In.	mm	In.	mm	In.	mm	In.	mm			In.	mm	Lbs.	N			

Weather Resistant Nylon 6.6

Miniature Cross Section

BC1M-S4-M0	4.6	117	.095	2.4	.046	1.2	.122	3.1	#4	M2.5	.90	23	18	80	GTS, GTSL, GS2B, PTS, PPTS, STS2	1000	50000
BC2M-S4-M0	8.3	211	.095	2.4	.046	1.2	.122	3.1	#4	M2.5	2.00	51	18	80	GTS, GTSL, GS2B, PTS, PPTS, STS2	1000	25000

Intermediate Cross Section

BC1.5I-S8-M0	6.6	168	.141	3.6	.041	1.0	.174	4.4	#8	M4	1.50	38	40	178	GTS, GTSL, GS2B, PTS, PPTS, STS2	1000	25000
--------------	-----	-----	------	-----	------	-----	------	-----	----	----	------	----	----	-----	----------------------------------	------	-------

Standard Cross Section

BC2S-S10-C0	8.5	216	.185	4.7	.052	1.3	.200	5.1	#10	M5	2.00	51	50	222	GTS, GTSL, GS2B, GTH, GS4H, PTS, PTH, PPTS, STS2, STH2	100	1000
BC3S-S10-D0	12.5	318	.185	4.7	.052	1.3	.200	5.1	#10	M5	3.00	76	50	222		500	5000
BC4S-S10-C0	15.6	396	.185	4.7	.052	1.3	.200	5.1	#10	M5	4.00	102	50	222		100	1000

Light-Heavy Cross Section (Straight Tip)

BC4LH-S25-L0	15.5	394	.275	7.0	.065	1.7	.260	6.6	1/4	M6	4.00	102	120	534	GTH, GS4H, GS4EH, PTH, STH2, ST3EH	50	500
--------------	------	-----	------	-----	------	-----	------	-----	-----	----	------	-----	-----	-----	------------------------------------	----	-----

Heat Stabilized Nylon 6.6

Standard Cross Section

BC4S-S10-D30	15.6	396	.185	4.7	.052	1.3	.200	5.1	#10	M5	4.00	102	50	222	GTS, GTSL, GS2B, GTH, GS4H, PTS, PTH, PPTS, STH2, STS2	500	5000
--------------	------	-----	------	-----	------	-----	------	-----	-----	----	------	-----	----	-----	--	-----	------

Note: UL Recognized and CSA Certified except BC4LH-S25-L0.

A.
System
Overview

B1.
Cable Ties

B2.
Cable
Accessories

B3.
Stainless
Steel Ties

C1.
Wiring
Duct

C2.
Surface
Raceway

C3.
Abrasion
Protection

C4.
Cable
Management

D1.
Terminals

D2.
Power
Connectors

D3.
Grounding
Connectors

E1.
Labeling
Systems

E2.
Labels

E3.
Pre-Printed
& Write-On
Markers

E4.
Permanent
Identification

E5.
Lockout/
Tagout
& Safety
Solutions

F.
Index

A. System Overview



DOME-TOP® Barb Ty Wing Push Mount Ties – Nylon and Weather Resistant Nylon 6.6

B1. Cable Ties

- Natural nylon material for indoor use
- Weather resistant material has greater resistance to damage caused by ultraviolet light – indoor or outdoor use
- Combine cable tie, mount, and fastener into a single part
- Used to attach bundles to another surface such as a flat panel
- Anchor is easily pressed into a pre-formed hole and locks in place

- Wings provide constant tension for a stable, secure, and rattle-free installation
- Stainless steel locking barb provides consistent performance, reliability, and infinite adjustability through entire bundle range
- Curved tip is easy to pick up from flat surfaces and allows faster initial threading to speed installation

B2. Cable Accessories

B3. Stainless Steel Ties



BW2S-D



BW2S-D0

C1. Wiring Duct

C2. Surface Raceway

C3. Abrasion Protection

C4. Cable Management

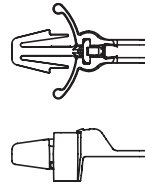
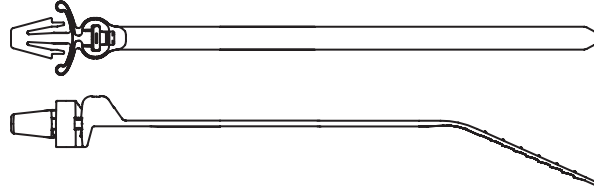
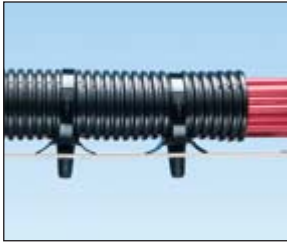

BW2S Head Design

D1. Terminals

Part Number	Length		Width		Thickness		Nominal Hole Dia.		Max. Panel Thickness		Max. Bundle Dia.		Min. Loop Tensile Str.		Recommended Installation Tool	Std. Pkg. Qty.	Std. Ctn. Qty.
	In.	mm	In.	mm	In.	mm	In.	mm	In.	mm	In.	mm	Lbs.	N			

D2. Power Connectors

Nylon 6.6

Intermediate Cross Section

BW1.5I-D	6.6	168	.141	3.6	.041	1.0	.187	4.7	.093	2.4	1.50	38	40	178	GTS, GTSL, GS2B, PTS, PPTS, STS2	500	5000
-----------------	-----	-----	------	-----	------	-----	------	-----	------	-----	------	----	----	-----	----------------------------------	-----	------

D3. Grounding Connectors

Standard Cross Section

BW2S-D	8.5	216	.185	4.7	.052	1.3	.250	6.4	.156	4.0	2.00	51	50	222	GTS, GTSL, GS2B, GTH, GS4H, PTS, PTH, PPTS, STS2, STH2	500	5000
BW3S-D	12.5	318	.185	4.7	.052	1.3	.250	6.4	.156	4.0	3.00	76	50	222		500	5000

E1. Labeling Systems

Weather Resistant Nylon 6.6

Standard Cross Section

BW2S-D0	8.5	216	.185	4.7	.052	1.3	.250	6.4	.156	4.0	2.00	51	50	222	GTS, GTSL, GS2B, GTH, GS4H, PTS, PTH, PPTS, STS2, STH2	500	5000
BW3S-D0	12.5	318	.185	4.7	.052	1.3	.250	6.4	.156	4.0	3.00	76	50	222		500	5000

E3. Pre-Printed & Write-On Markers

E4. Permanent Identification

E5. Lockout/Tagout & Safety Solutions

F. Index

UL US CS DOME-TOP® Barb Ty Push Mount Ties – Weather Resistant Nylon 6.6

- Greater resistance to damage caused by ultraviolet light – indoor or outdoor use
- Used to attach bundles to another surface such as a flat panel
- Cable tie, mount, and fastener in a single part
- Anchor is easily pressed into a pre-formed hole and locks in place

- *Wingless* design allows tie to be used in confined spaces
- Stainless steel locking barb provides consistent performance, reliability, and infinite adjustability through entire bundle range
- Curved tip is easy to pick up from flat surfaces and allows faster initial threading to speed installation

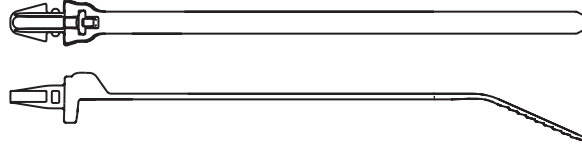
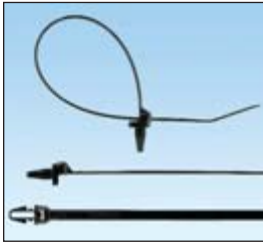

Part Number	Length		Width		Thickness		Nominal Hole Dia.		Max. Panel Thickness		Max. Bundle Dia.		Min. Loop Tensile Str.		Recommended Installation Tool	Std. Pkg. Qty.	Std. Ctn. Qty.
	In.	mm	In.	mm	In.	mm	In.	mm	In.	mm	In.	mm	Lbs.	N			
Standard Cross Section																	
BP2S-D0	8.5	216	.185	4.7	.052	1.3	.255	6.5	.150	3.8	2.00	51	50	222	GTS, GTSL, GS2B, GTH, GS4H, PTS, PTH, PPTS, STS2, STH2	500	5000

Permanent Marking Pens

- Fast drying, permanent ink for identification on marker ties (pages B1.34, B1.52, and B1.71), marker plates (page B2.29), or cable marker straps (page B1.80)
- May be used with any label shown in the catalog when a printer is not available



PX-0
PX-2



PFX-0
PFX-2



PX-10

Part Number	Color	Description	Std. Pkg. Qty.	Std. Ctn. Qty.
PX-0	Black	Permanent marking pen – regular tip.	12	144
PX-2	Red	Permanent marking pen – regular tip.	12	144
PFX-0	Black	Permanent marking pen – fine tip.	12	144
PFX-2	Red	Permanent marking pen – fine tip.	12	144
PX-10	White	Marking pen for black or other dark colored parts – regular tip.	12	300

A.
System
Overview

B1.
Cable Ties

B2.
Cable
Accessories

B3.
Stainless
Steel Ties

C1.
Wiring
Duct

C2.
Surface
Raceway

C3.
Abrasion
Protection

C4.
Cable
Management

D1.
Terminals

D2.
Power
Connectors

D3.
Grounding
Connectors

E1.
Labeling
Systems

E2.
Labels

E3.
Pre-Printed
& Write-On
Markers

E4.
Permanent
Identification

E5.
Lockout/
Tagout
& Safety
Solutions

F.
Index

A.
System
Overview

UL[®] US[®] CS[®] DOME-TOP® Barb Ty Marker and Flag Ties

B1.
Cable Ties

- Natural nylon material for indoor use
- Weather resistant material has greater resistance to damage caused by ultraviolet light – indoor or outdoor use
- Used to fasten and identify bundles at the same time
- Can be marked with *PANDUIT* marker pens on the previous page or computer printable labels
- Custom imprinting with text, symbols, or trademarks available using *PANDUIT* Custom Hot Stamping Service, see page B1.91
- Stainless steel locking barb provides consistent performance, reliability, and infinite adjustability through entire bundle range
- Curved tip is easy to pick up from flat surfaces and allows faster initial threading to speed installation

B2.
Cable
Accessories

B3.
Stainless
Steel Ties

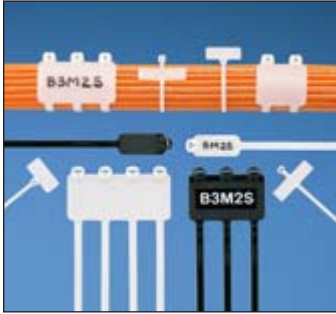

C1.
Wiring
Duct

C2.
Surface
Raceway

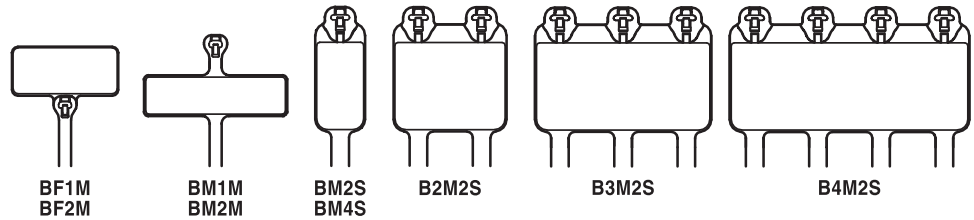

C3.
Abrasion
Protection

C4.
Cable
Management

D1.
Terminals

D2.
Power
Connectors

D3.
Grounding
Connectors

E1.
Labeling
Systems

E2.
Labels

E3.
Pre-Printed
& Write-On
Markers

E4.
Permanent
Identification

E5.
Lockout/
Tagout
& Safety
Solutions

F.
Index

Part Number	Marker Type	Length		Width		Thickness		Marker Write-On Area		Max. Bundle Dia.		Min. Loop Tensile Str.		Recommended Installation Tool	Std. Pkg. Qty.	Std. Ctn. Qty.
		In.	mm	In.	mm	In.	mm	In.	mm	In.	mm	Lbs.	N			

Nylon 6.6

Miniature Cross Section

BF1M-C	Flag	4.6	117	.095	2.4	.046	1.2	.36 x .81	9.1 x 20.6	.90	23	18	80	GTS, GTSL, GS2B, PTS, PPTS, STS2	100	1000
BF2M-C	Flag	8.3	211	.095	2.4	.046	1.2	.36 x .81	9.1 x 20.6	2.00	51	18	80		100	1000
BM1M-C	Wrap	4.2	107	.095	2.4	.046	1.2	.29 x 1.09	7.4 x 27.7	.90	23	18	80		100	1000
BM2M-C	Wrap	7.9	201	.095	2.4	.046	1.2	.29 x 1.09	7.4 x 27.7	2.00	51	18	80		100	1000

Standard Cross Section

BM2S-C	Wrap	8.0	203	.185	4.7	.045	1.2	.49 x .91	12.4 x 23.1	2.00	51	50	222	GTS, GTSL, GS2B, GTH, GS4H, PTS, PTH, PPTS, STS2, STH2	100	1000
BM4S-C	Wrap	15.1	384	.185	4.7	.052	1.3	.50 x 2.13	12.7 x 54.1	4.00	102	50	222		100	1000
B2M2S-D	Wrap	8.0	203	.185	4.7	.045	1.2	1.15 x .91	29.2 x 23.1	2.00	51	50	222		500	2500
B3M2S-TL	Wrap	8.0	203	.185	4.7	.045	1.2	1.81 x .91	46.0 x 23.1	2.00	51	50	222		250	2500
B4M2S-TL	Wrap	8.0	203	.185	4.7	.045	1.2	2.47 x .91	62.7 x 23.1	2.00	51	50	222		250	2500

Weather Resistant Nylon 6.6

Miniature Cross Section

BF1M-M0	Flag	4.6	117	.095	2.4	.046	1.2	.36 x .81	9.1 x 20.6	.90	23	18	80	GTS, GTSL, GS2B, PTS, PPTS, STS2	1000	25000
BF2M-M0	Flag	8.3	211	.095	2.4	.046	1.2	.36 x .81	9.1 x 20.6	2.00	51	18	80		1000	25000
BM1M-M0	Wrap	4.2	107	.095	2.4	.046	1.2	.29 x 1.09	7.4 x 27.7	.90	23	18	80		1000	25000
BM2M-M0	Wrap	7.9	201	.095	2.4	.046	1.2	.29 x 1.09	7.4 x 27.7	2.00	51	18	80		1000	25000

Standard Cross Section

BM2S-D0	Wrap	8.0	203	.185	4.7	.045	1.2	.49 x .91	12.4 x 23.1	2.00	51	50	222	GTS, GTSL, GS2B, GTH, GS4H, PTS, PTH, PPTS, STS2, STH2	500	10000
BM4S-D0	Wrap	15.1	384	.185	4.7	.052	1.3	.50 x 2.13	12.7 x 54.1	4.00	102	50	222		500	5000
B2M2S-D0	Wrap	8.0	203	.185	4.7	.045	1.2	1.15 x .91	29.2 x 23.1	2.00	51	50	222		500	2500
B3M2S-TL0	Wrap	8.0	203	.185	4.7	.045	1.2	1.81 x .91	46.0 x 23.1	2.00	51	50	222		250	2500
B4M2S-TL0	Wrap	8.0	203	.185	4.7	.045	1.2	2.47 x .91	62.7 x 23.1	2.00	51	50	222		250	2500



DURA-TY™ Cable Ties – Weather Resistant Acetal – Heavy Cross Section

- Black acetal strap and head material provide 20+ years outdoor life and high impact resistance
- Excellent ultraviolet light, chemical, and moisture resistance



- Double stainless steel locking barbs provide consistent and predictable holding values
- Textured strap provides better gripping surface to prevent tie from moving laterally along the length of the bundle for tight, consistent bundles
- Robust head design allows tie to be tightened over a wide range of angles
- Convenient reel dispenser pack allows installer to cut-to-size for customized field applications; recyclable box has through-hole for attaching to belt, plus storage area for bag of heads
- Ideal for securing cables in outdoor messenger strand applications
- May be used with stackable aerial cable spacer on the next page

Part Number	Description	Strap Length		Strap Width		Min. Loop Tensile Str.		Head Height		Head Width		Recommended Installation Tool	Std. Pkg. Qty.	Std. Ctn. Qty.
		Ft.	m	In.	mm	Lbs.	N	In.	mm	In.	mm			
Strapping, Heads, and Kit – Allows user to customize strap length														
DTRH-LR0	50' reel of strapping.	50.0	15.2	.331	8.40	200	890	—	—	—	—	GTH, GS4EH, STH2, STHV, ST3EH	1	20
DTHH-Q0	25 cable tie heads.	—	—	—	—	—	—	.393	9.98	.557	14.15	—	25	500
DTKH-0	Kit: Strapping (50'), Heads (25)	50.0	15.2	.331	8.40	200	890	.393	9.98	.557	14.15	GTH, GS4EH, STH2, STHV, ST3EH	1	20

DURA-TY™ Cable Ties – Weather Resistant Acetal – Extra-Heavy Cross Section

- Black acetal strap and head material provide 20+ years outdoor life and high impact resistance
- Excellent ultraviolet light, chemical, and moisture resistance
- Double stainless steel locking barbs provide consistent and predictable holding values
- Ideal for securing cables in outdoor messenger strand applications
- Meets Telcordia TR-TSY-000789 industry guidelines for lashed cable supports

- Convenient reel dispenser pack allows installer to cut-to-size for customized field applications; recyclable box has through-hole for attaching to belt, plus storage area for bag of heads
- Several pre-cut sizes have lead-in style angled tips on pre-assembled straps for easy installation, even with gloved hands, to speed installation
- May be used with stackable aerial cable spacer on the next page



Formula to determine amount of strapping required:
 Diameter (inches) x 3.14 + 4.5 inches
 Diameter (mm) x 3.14 + 114mm

Part Number	Description	Strap Length		Strap Width		Min. Loop Tensile Str.		Head Height		Head Width		Recommended Installation Tool	Std. Pkg. Qty.	Std. Ctn. Qty.
		Ft.	m	In.	mm	Lbs.	N	In.	mm	In.	mm			
Strapping, Heads, and Kit – Allows user to customize strap length														
DTREH-LR0	50' reel of strapping.	50.0	15.2	.500	12.70	250	1112	—	—	—	—	GS4EH, ST3EH	1	20
DTHEH-Q0	25 cable tie heads.	—	—	—	—	—	—	.490	12.45	.718	18.24	—	25	500
DTKEH-0	Kit: Strapping (50'), Heads (25)	50.0	15.2	.500	12.70	250	1112	.490	12.45	.718	18.24	GS4EH, ST3EH	1	20

Part Number	Length		Width		Thickness		Head Height		Head Width		Max. Bundle Dia.	Min. Loop Tensile Strength	Recommended Installation Tool	Std. Pkg. Qty.	Std. Ctn. Qty.		
	In.	mm	In.	mm	In.	mm	In.	mm	In.	mm							
Discrete Lengths – Speed installation																	
DT4EH-L0	13.5	343	.500	12.70	.059	1.50	.490	12.45	.718	18.24	3.8	98	250	1112	GS4EH, ST3EH	50	1000
DT8EH-Q0	27.0	686	.500	12.70	.059	1.50	.490	12.45	.718	18.24	8.0	203	250	1112		25	500
DT14EH-L0	48.0	1219	.500	12.70	.059	1.50	.490	12.45	.718	18.24	14.0	355	250	1112		50	250
DT15EH-L0	53.0	1346	.500	12.70	.059	1.50	.490	12.45	.718	18.24	15.0	381	250	1112		50	250
DT28EH-C0	96.0	2438	.500	12.70	.059	1.50	.490	12.45	.718	18.24	28.0	711	250	1112		100	—
DT44EH-C0	144.0	3658	.500	12.70	.059	1.50	.490	12.45	.718	18.24	44.0	1117	250	1112		100	—

A.
System
Overview

Stackable Aerial Cable Spacer – Weather Resistant Polypropylene

B1.
Cable Ties

- Greater resistance to damage caused by ultraviolet light – indoor or outdoor use
- Each spacer snaps into another to increase spacer heights by 1/2" increments

- Designed for use in parallel or perpendicular applications
- For use with *DURA-TY™* Cable Ties shown on the previous page

B2.
Cable
Accessories

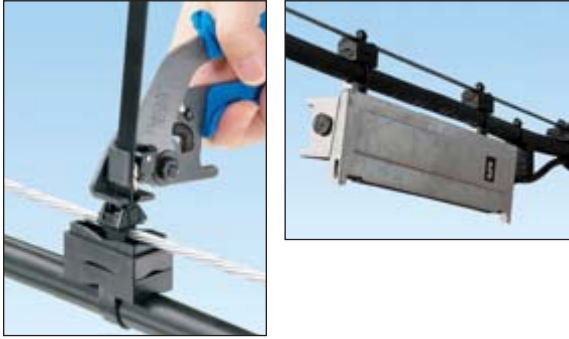

B3.
Stainless
Steel Ties

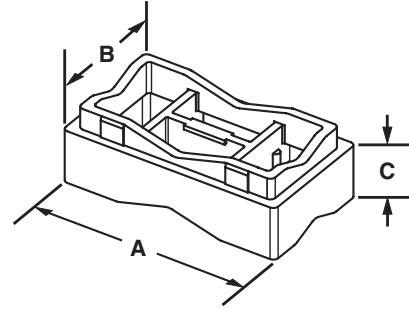

C1.
Wiring
Duct

C2.
Surface
Raceway

Part Number	Length A		Width B		Height C		Used With Cable Ties*	Std. Pkg. Qty.	Std. Ctn. Qty.
	In.	mm	In.	mm	In.	mm			
SACS5-T100	2.08	52.8	1.16	29.5	.71	18.0	LH, H, EH	200	2000

*Cable tie cross section sizes: LH = Light-Heavy, H = Heavy, and EH = Extra-Heavy.

C3.
Abrasion
Protection

C4.
Cable
Management

D1.
Terminals

DOME-TOP® Barb Ty and *DURA-TY™* Cable Ties

D2.
Power
Connectors

Material and Color Chart

D3.
Grounding
Connectors

Material	Color	PANDUIT Suffix
Nylon 6.6	Natural	✓
Weather Resistant Nylon 6.6	Black	0
Nylon 6.6	Brown	1
Nylon 6.6	Red	2
Nylon 6.6	Orange	3
Nylon 6.6	Yellow	4Y
Nylon 6.6	Green	5
Nylon 6.6	Blue	6

Material	Color	PANDUIT Suffix
Nylon 6.6	Purple	7
Nylon 6.6	Gray	8
Nylon 6.6	White	10
Nylon 6.6	Telephone Gray	14
Nylon 6.6	Black	20
Heat Stabilized Nylon 6.6	Black	30
Heat Stabilized Nylon 6.6	Natural	39
Flame Retardant Nylon 6.6	Natural (Ivory)	69
Weather Resistant Acetal	Black	*

✓ Denotes *PANDUIT* Natural Nylon 6.6 (no suffix).

*Denotes *DURA-TY™* Weather Resistant Acetal material (no suffix).

E3.
Pre-Printed
& Write-On
Markers

E4.
Permanent
Identification

E5.
Lockout/
Tagout/
& Safety
Solutions

F.
Index

Part Number Availability List

Standard Packaging			Bulk Packaging		
Part Number	Natural Nylon 6.6	Material/Color Suffix	Part Number	Natural Nylon 6.6	Material/Color Suffix
			BC1M-S4-M	✓	0
			BC2M-S4-M	✓	0
			BC1.5I-S8-M	✓	0
BC2S-S10-C	✓	0	BC2S-S10-D	✓	0
			BC3S-S10-D	✓	0
BC4S-S10-C	✓	0	BC4S-S10-D	✓	0,30
BC4LH-S25-L	✓	0	BC4LH-S25-TL	✓	0
BF1M-C	✓		BF1M-M	✓	0
BF2M-C	✓		BF2M-M	✓	0
BM1M-C	✓		BM1M-M	✓	0
BM2M-C	✓		BM2M-M	✓	0
BM2S-C	✓		BM2S-D	✓	0
BM4S-C	✓		BM4S-D	✓	0
			BP2S-D		0
BT1M-C	✓	0,30	BT1M-M	✓	0,1,2,3,4Y,5,6,7,8,10,30,39
			BT1M-XMR	✓	0,30
BT1.5M-C	✓	0	BT1.5M-M	✓	0,30
			BT1.5M-XMR	✓	0,30,69
BT2M-C	✓	0	BT2M-M	✓	0,2,3,4Y,5,6,8,30
BT4M-C	✓	0	BT4M-M	✓	0
BT1.5I-C	✓	0	BT1.5I-M	✓	0,1,2,3,4Y,5,6,7,8,10,30,39
BT2I-C	✓	0	BT2I-M	✓	0,30
BT3I-C	✓	0	BT3I-M	✓	0,14,30
BT4I-C	✓	0	BT4I-M	✓	0,14
BT2S-C	✓	0	BT2S-M	✓	0,1,2,3,4Y,5,6,7,8,10,20,30,39
BT3S-C	✓	0,2	BT3S-M	✓	0,30,39
BT4S-C	✓	0	BT4S-M	✓	0,2,3,4Y,5,6,7,8,10,30,39
BT2LH-L	✓	0	BT2LH-TL	✓	0
BT3LH-L	✓	0	BT3LH-TL	✓	0
BT4LH-L	✓	0	BT4LH-TL	✓	0,30,39
BT5LH-L	✓	0	BT5LH-C	✓	0
BT6LH-L	✓	0	BT6LH-C	✓	0
BT7LH-L	✓	0	BT7LH-C	✓	0
BT8LH-L	✓	0	BT8LH-C	✓	0
BT9LH-L	✓	0	BT9LH-C	✓	0
			BW1.5I-D	✓	
			BW2S-D	✓	0
			BW3S-D	✓	0
			B2M2S-D	✓	0
			B3M2S-TL	✓	0
			B4M2S-TL	✓	0

DURA-TY™ Cable Ties and Strapping

DTHEH-Q0, DTHH-Q0	*				
DTKEH-0, DTKH-0	*				
DTREH-LR0	*				
DTRH-LR0	*				
DT4EH-L0	*				
DT8EH-Q0	*				
DT14EH-L0	*		DT14EH-C0	*	
DT15EH-L0	*				
DT28EH-C0	*				
DT44EH-C0	*				

*Denotes DURA-TY™ Weather Resistant Acetal material (no suffix).

A.
System
Overview

Features and Benefits – Parallel-Entry Cable Ties

Parallel-entry cable ties limit exposure to sharp edges and protect workers' arms/hands. The ties are designed with a low profile head to avoid snags and reduce overall bundle size.

B1.
Cable Ties

CONTOUR-TY® Cable Ties

Fully enclosed head for consistent strength

Fully rounded edges on head and strap

Outside teeth and smooth round edges protect cable jacket – ideal for high vibration applications

Curved tip threads easily and installs faster

Rounded tip and aggressive grip for faster initial threading

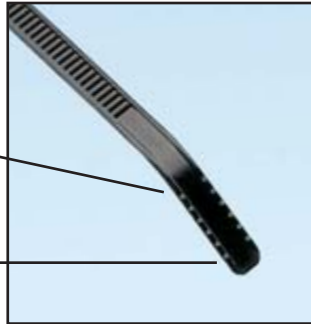

HYPER-V™ Cable Ties

Design provides for an optional threading position that allows releasable, temporary bundling

Fixed and flexible 2-wedge locking design

Tip bending serrations and threading hole facilitate installations in confined spaces

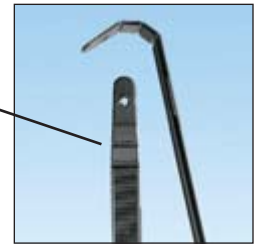
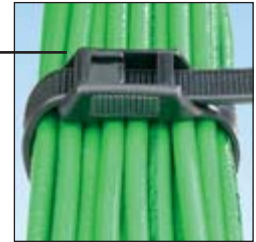

C1.
Wiring
Duct

C2.
Surface
Raceway

C3.
Abrasion
Protection

C4.
Cable
Management

D1.
Terminals

BELT-TY™ In-Line Cable Ties



"Finger grip" shaped head assures positive grip while threading tie

Parallel-entry limits exposure to sharp edges and protects workers' arms/hands



IN-LINE Cable Ties

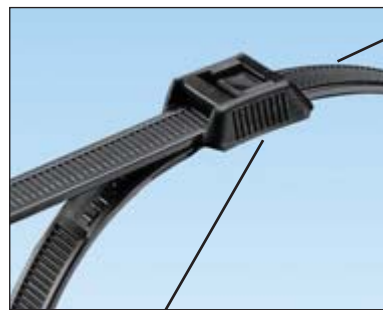

Outside teeth protect cable jacket and wire insulation

"Finger grip" shaped head with serrations assures positive grip while threading tie



D2.
Power
Connectors

D3.
Grounding
Connectors

E1.
Labeling
Systems

E2.
Labels

E3.
Pre-Printed
& Write-On
Markers

E4.
Permanent
Identification

E5.
Lockout/
Tagout
& Safety
Solutions

F.
Index



Cable tie tools speed installation and reduce total installed cost. See pages B1.107 – B1.112.



Cable tie accessories are used to speed and simplify the mounting of wires, cables, and tubing. See pages B2.1 – B2.29.

Selection Guide – Parallel-Entry Cable Ties

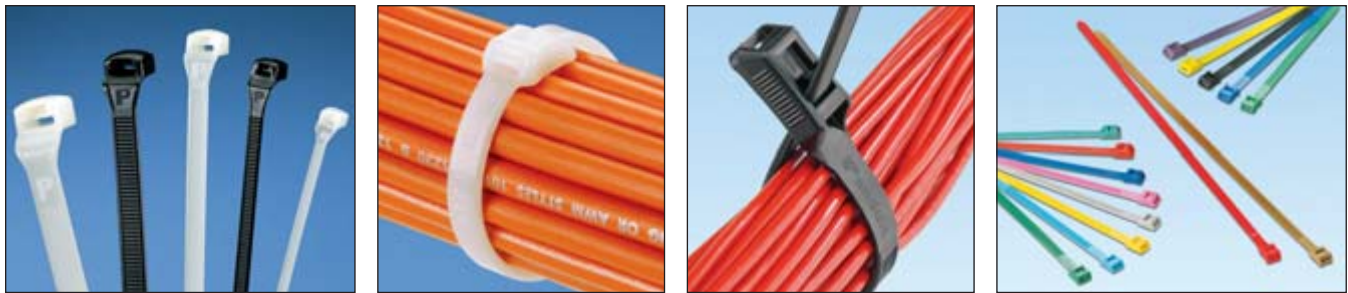

	Material, Color (Suffix)	Style/Function	Part Number Prefix	Catalog Page
CONTOUR-TY® Cable Ties	Nylon 6.6, Natural (No Suffix)	Locking Ties/Bundle	CBR	B1.58
	Weather Resistant Nylon 6.6, Black (0)	Locking Ties/Bundle	CBR	B1.59
	Heat Stabilized Nylon 6.6, Black (30)	Locking Ties/Bundle	CBR	B1.60
	Heat Stabilized Nylon 6.6, Natural (39)	Locking Ties/Bundle	CBR	B1.60
	Flame Retardant Nylon 6.6, Ivory (69)	Locking Ties/Bundle	CBR	B1.60
BELT-TY™ In-Line Cable Ties	Nylon 6.6, Natural (No Suffix)	Locking Ties/Bundle	ILT	B1.61
	Weather Resistant Nylon 6.6, Black (0)	Locking Ties/Bundle	ILT	B1.61
HYPER-V™ Cable Ties	Weather Resistant Nylon 6.6, Black (0)	Locking Ties/Bundle	HV	B1.62
IN-LINE Cable Ties	Weather Resistant Nylon 6.6, Black (0 and colors)	Locking Ties/Bundle	IT	B1.63

Part Number System for CONTOUR-TY® and BELT-TY™ Cable Ties

<u>CBR</u>	<u>2</u>	<u>S</u>	—	<u>M</u>	<u> </u>
Type	Size	Cross Section		Package Size	Material/Color
CBR = Locking Tie ILT = Locking Tie	Approx. Maximum Bundle Dia. (In.)	M = Miniature I = Intermediate S = Standard HS = Heavy-Standard LH = Light-Heavy		C = 100 TL = 250 D = 500 M = 1000	See page B1.64

Part Number System for HYPER-V™ and IN-LINE Cable Ties

<u>HV</u>	<u>9</u>	<u>100</u>	—	<u>C</u>	<u> </u>
Type	Width	Size		Package Size	Material/Color
HV = Locking Tie IT = Locking Tie	Approx. Width (mm)	Approx. Maximum Bundle Dia. (mm)		C = 100	See page B1.64

A.
System
Overview



CONTOUR-TY® Cable Ties – Nylon 6.6

B1.
Cable Ties

- For indoor use
- Unique design prevents wire and cable damage
- Low profile head avoids snags and reduces overall bundle size
- Outside teeth and smooth round edges protect cable jacket – ideal for high vibration applications
- Parallel-entry limits exposure to sharp edges and protects workers' arms/hands
- Fully enclosed head for consistent strength

- Curved tip is easy to pick up from flat surfaces and allows faster initial threading to speed installation

Note: Nylon 6.6 cable ties in natural and colors meet the testing requirements of the U.S. Military Aerospace Standard SAE-AS23190A and the dimensional requirements of Aerospace Standard SAE-AS33671.

B2.
Cable
Accessories

B3.
Stainless
Steel Ties



C1.
Wiring
Duct

C2.
Surface
Raceway

C3.
Abrasion
Protection

C4.
Cable
Management

D1.
Terminals

D2.
Power
Connectors

D3.
Grounding
Connectors

E1.
Labeling
Systems

E2.
Labels

E3.
Pre-Printed
& Write-On
Markers

E4.
Permanent
Identification

E5.
Lockout/
Tagout/
& Safety
Solutions

F.
Index

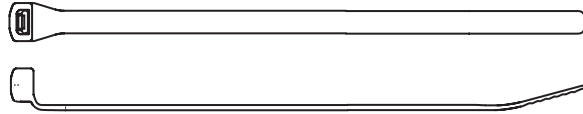

Part Number	Length		Width		Thickness		Max. Bundle Dia.		Min. Loop Tensile Str.		Recommended Installation Tool	Std. Pkg. Qty.	Std. Ctn. Qty.
	In.	mm	In.	mm	In.	mm	In.	mm	Lbs.	N			
Miniature Cross Section													
CBR1M-M	4.1	104	.098	2.5	.038	1.0	1.00	25	18	80	GTS, GTSL, GS2B, PTS, PPTS, STS2	1000	50000
CBR1.5M-M	5.6	142	.098	2.5	.042	1.1	1.50	38	18	80		1000	50000
CBR2M-M	7.2	183	.098	2.5	.042	1.1	2.00	51	18	80		1000	25000
Intermediate Cross Section													
CBR1.5I-M	5.9	150	.140	3.6	.040	1.0	1.50	38	40	178	GTS, GTSL, GS2B, PTS, PPTS, STS2	1000	25000
CBR3I-M	10.4	264	.140	3.6	.052	1.3	3.00	76	40	178		1000	10000
CBR4I-M	13.6	345	.140	3.6	.052	1.3	4.00	102	40	178		1000	10000
Standard Cross Section													
CBR2S-M	7.6	193	.190	4.8	.044	1.1	2.00	51	50	222	GTS, GTSL, GS2B, GTH, GS4H, PTS, PTH, PPTS, STS2, STH2	1000	10000
CBR3S-M	10.8	274	.190	4.8	.052	1.3	3.00	76	50	222		1000	5000
CBR4S-M	14.0	356	.190	4.8	.052	1.3	4.00	102	50	222		1000	5000
Heavy-Standard Cross Section													
CBR2HS-D	8.0	203	.250	6.4	.058	1.4	2.00	51	85	378	GTH, GS4H, GS4EH, PTH, STH2, ST3EH	500	5000
Light-Heavy Cross Section													
CBR4LH-TL	14.6	371	.300	7.6	.070	1.8	4.00	102	120	534	GTH, GS4H, GS4EH, PTH, STH2, ST3EH	250	2500
CBR6LH-C	20.9	531	.300	7.6	.070	1.8	6.00	152	120	534		100	2000



CONTOUR-TY® Cable Ties – Weather Resistant Nylon 6.6

- Greater resistance to damage caused by ultraviolet light – indoor or outdoor use
- Unique design prevents wire and cable damage
- Low profile head avoids snags and reduces overall bundle size
- Outside teeth and smooth round edges protect cable jacket – ideal for high vibration applications

- Parallel-entry limits exposure to sharp edges and protects workers' arms/hands
- Fully enclosed head for consistent strength
- Curved tip is easy to pick up from flat surfaces and allows faster initial threading to speed installation

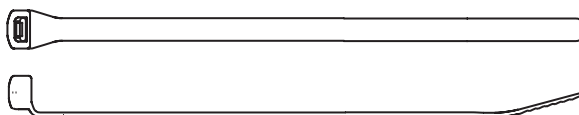

Part Number	Length		Width		Thickness		Max. Bundle Dia.		Min. Loop Tensile Str.		Recommended Installation Tool	Std. Pkg. Qty.	Std. Ctn. Qty.
	In.	mm	In.	mm	In.	mm	In.	mm	Lbs.	N			
Miniature Cross Section													
CBR1M-M0	4.1	104	.098	2.5	.038	1.0	1.00	25	18	80	GTS, GTSL, GS2B, PTS, PPTS, STS2	1000	50000
CBR1.5M-M0	5.6	142	.098	2.5	.042	1.1	1.50	38	18	80		1000	50000
CBR2M-M0	7.2	183	.098	2.5	.042	1.1	2.00	51	18	80		1000	25000
Intermediate Cross Section													
CBR1.5I-M0	5.9	150	.140	3.6	.040	1.0	1.50	38	40	178	GTS, GTSL, GS2B, PTS, PPTS, STS2	1000	25000
CBR3I-M0	10.4	264	.140	3.6	.052	1.3	3.00	76	40	178		1000	10000
CBR4I-M0	13.6	345	.140	3.6	.052	1.3	4.00	102	40	178		1000	10000
Standard Cross Section													
CBR2S-M0	7.6	193	.190	4.8	.044	1.1	2.00	51	50	222	GTS, GTSL, GS2B, GTH, GS4H, PTS, PTH, PPTS, STS2, STH2	1000	10000
CBR3S-M0	10.8	274	.190	4.8	.052	1.3	3.00	76	50	222		1000	5000
CBR4S-M0	14.0	356	.190	4.8	.052	1.3	4.00	102	50	222		1000	5000
Heavy-Standard Cross Section													
CBR2HS-D0	8.0	203	.250	6.4	.058	1.4	2.00	51	85	378	GTH, GS4H, GS4EH, PTH, STH2, ST3EH	500	5000
Light-Heavy Cross Section													
CBR4LH-TL0	14.6	371	.300	7.6	.070	1.8	4.00	102	120	534	GTH, GS4H, GS4EH, PTH, STH2, ST3EH	250	2500
CBR6LH-C0	20.9	531	.300	7.6	.070	1.8	6.00	152	120	534		100	2000

A. System Overview

B1. Cable Ties

B2. Cable Accessories

B3. Stainless Steel Ties

C1. Wiring Duct

C2. Surface Raceway

C3. Abrasion Protection

C4. Cable Management

D1. Terminals

D2. Power Connectors

D3. Grounding Connectors

E1. Labeling Systems

E2. Labels

E3. Pre-Printed & Write-On Markers

E4. Permanent Identification

E5. Lockout/Tagout & Safety Solutions

F. Index

A. System Overview



CONTOUR-TY® Cable Ties – Heat Stabilized and Flame Retardant Nylon 6.6

B1. Cable Ties

- Heat stabilized material for high temperature applications up to 239°F (115°C) – indoor use
- Flame retardant material has a flammability rating of UL 94V-0 – indoor use
- Unique design prevents wire and cable damage
- Low profile head avoids snags and reduces overall bundle size
- Outside teeth and smooth round edges protect cable jacket – ideal for high vibration applications
- Parallel-entry limits exposure to sharp edges and protects workers' arms and hands
- Fully enclosed head for consistent strength
- Curved tip is easy to pick up from flat surfaces and allows faster initial threading to speed installation

B2. Cable Accessories

B3. Stainless Steel Ties

C1. Wiring Duct

C2. Surface Raceway



CBR2S-M30



CBR2S-M39



CBR3S-M69

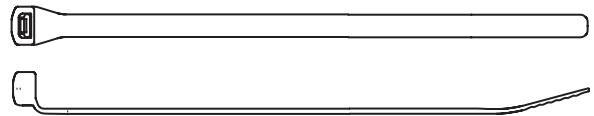

C3. Abrasion Protection

C4. Cable Management

D1. Terminals

D2. Power Connectors

D3. Grounding Connectors

E1. Labeling Systems

E2. Labels

E3. Pre-Printed & Write-On Markers

E4. Permanent Identification

E5. Lockout/Tagout & Safety Solutions

F. Index

Part Number	Length		Width		Thickness		Max. Bundle Dia.		Min. Loop Tensile Str.		Recommended Installation Tool	Std. Pkg. Qty.	Std. Ctn. Qty.
	In.	mm.	In.	mm	In.	mm	In.	mm	Lbs.	N			

Heat Stabilized Nylon 6.6 – Black

Miniature Cross Section

CBR1M-M30	4.1	104	.098	2.5	.038	1.0	1.00	25	18	80	GTS, GTSL, GS2B, PTS, PPTS, STS2	1000	50000
------------------	-----	-----	------	-----	------	-----	------	----	----	----	----------------------------------	------	-------

Intermediate Cross Section

CBR1.5I-M30	5.9	150	.140	3.6	.040	1.0	1.50	38	40	178	GTS, GTSL, GS2B, PTS, PPTS, STS2	1000	25000
--------------------	-----	-----	------	-----	------	-----	------	----	----	-----	----------------------------------	------	-------

Standard Cross Section

CBR2S-M30	7.6	193	.190	4.8	.044	1.1	2.00	51	50	222	GTS, GTSL, GS2B, GTH, GS4H, PTS, PTH, PPTS, STS2, STH2	1000	10000
CBR3S-M30	10.8	274	.190	4.8	.052	1.3	3.00	76	50	222		1000	5000
CBR4S-M30	14.0	356	.190	4.8	.052	1.3	4.00	102	50	222		1000	5000

Light-Heavy Cross Section

CBR4LH-TL30	14.6	371	.300	7.6	.070	1.8	4.00	102	120	534	GTH, GS4H, GS4EH, PTH, STH2, ST3EH	250	2500
CBR6LH-C30	20.9	531	.300	7.6	.070	1.8	6.00	152	120	534		100	2000

Heat Stabilized Nylon 6.6 – Natural

Standard Cross Section

CBR2S-M39	7.6	193	.190	4.8	.044	1.1	2.00	51	50	222	GTS, GTSL, GS2B, GTH, GS4H, PTS, PTH, PPTS, STS2, STH2	1000	10000
------------------	-----	-----	------	-----	------	-----	------	----	----	-----	--	------	-------

Flame Retardant Nylon 6.6 – Natural Ivory

Standard Cross Section

CBR3S-M69	10.8	274	.190	4.8	.052	1.3	3.00	76	50	222	GTS, GTSL, GS2B, GTH, GS4H, PTS, PTH, PPTS, STS2, STH2	1000	5000
------------------	------	-----	------	-----	------	-----	------	----	----	-----	--	------	------

Note: UL Recognized, UL Listed, and CSA Certified, except CBR3S-M69.

UL US LISTED **UL US LISTED** **CSA US** **BELT-TY™ In-Line Cable Ties – Nylon and Weather Resistant Nylon 6.6**

- Natural nylon material for indoor use
- Weather resistant material has greater resistance to damage caused by ultraviolet light – indoor or outdoor use
- Parallel-entry cable tie that threads like a belt (180° entry)
- Low profile head avoids snags and reduces overall bundle size
- 35% lower head height than conventional 90° ties
- Parallel-entry limits exposure to sharp edges and protects workers' arms/hands
- Curved tip is easy to pick up from flat surfaces and allows faster initial threading to speed installation



ILT2S-C



ILT2S-C0

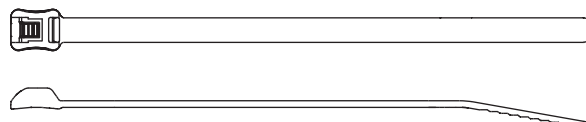

Part Number	Length		Width		Thickness		Max. Bundle Dia.		Min. Loop Tensile Str.		Recommended Installation Tool	Std. Pkg. Qty.	Std. Ctn. Qty.
	In.	mm	In.	mm	In.	mm	In.	mm	Lbs.	N			

Nylon 6.6

Standard Cross Section

ILT2S-C	8.3	211	.190	4.8	.052	1.3	1.88	48	50	222	GTS, GTSL, GS2B, GTH, GS4H, PTS, PTH, PPTS, STS2, STH2	100	1000
ILT3S-C	11.5	292	.190	4.8	.052	1.3	3.00	76	50	222		100	1000
ILT4S-C	14.7	373	.190	4.8	.052	1.3	4.00	102	50	222		100	1000

Light-Heavy Cross Section

ILT4LH-TL	14.8	376	.300	7.6	.075	1.9	4.00	102	120	534	GTH, GS4H, GS4EH, PTH, STH2, ST3EH	250	2500
ILT6LH-C	21.2	538	.300	7.6	.075	1.9	6.00	152	120	534		100	2000

Weather Resistant Nylon 6.6

Standard Cross Section

ILT2S-C0	8.3	211	.190	4.8	.052	1.3	1.88	48	50	222	GTS, GTSL, GS2B, GTH, GS4H, PTS, PTH, PPTS, STS2, STH2	100	1000
ILT3S-C0	11.5	292	.190	4.8	.052	1.3	3.00	76	50	222		100	1000
ILT4S-C0	14.7	373	.190	4.8	.052	1.3	4.00	102	50	222		100	1000

Light-Heavy Cross Section

ILT4LH-TL0	14.8	376	.300	7.6	.075	1.9	4.00	102	120	534	GTH, GS4H, GS4EH, PTH, STH2, ST3EH	250	2500
ILT6LH-C0	21.2	538	.300	7.6	.075	1.9	6.00	152	120	534		100	2000

Note: Nylon 6.6 cable ties are UL Listed for use in plenum or air handling spaces per NEC. Weather resistant nylon 6.6 cable ties are UL Recognized, UL Listed, and CSA Certified, except ILT4LH/6LH.

A. System Overview

B1. Cable Ties

B2. Cable Accessories

B3. Stainless Steel Ties

C1. Wiring Duct

C2. Surface Raceway

C3. Abrasion Protection

C4. Cable Management

D1. Terminals

D2. Power Connectors

D3. Grounding Connectors

E1. Labeling Systems

E2. Labels

E3. Pre-Printed & Write-On Markers

E4. Permanent Identification

E5. Lockout/Tagout & Safety Solutions

F. Index

A. System Overview



HYPER-V™ In-Line Cable Ties – Weather Resistant Nylon 6.6

B1. Cable Ties

- Fixed and flexible two-wedge locking design provides a low threading force
- Teeth on both sides of cable tie body provide additional locking strength and improved flexibility to conform to irregular bundle shapes such as securing cables to cable tray systems
- Releasable head position for temporary bundling of cables prior to final locking; no need to replace ties when adding cables/wires to the bundle
- Teeth on full length of body support a wide range of bundle diameters
- Bending serrations on the tip of the tie allow the tip to be easily formed into an arc, enabling installer to “fish” the tie around the bundle in a confined space
- Threading hole in the tip of the tie allows an installer to hook the tip with a simple device to pull the tie through spaces with limited access
- In-Line tie design for parallel-entry of the tie into head resulting in a lower profile on cable bundles
- Complementary mounts shown below

B2. Cable Accessories

B3. Stainless Steel Ties

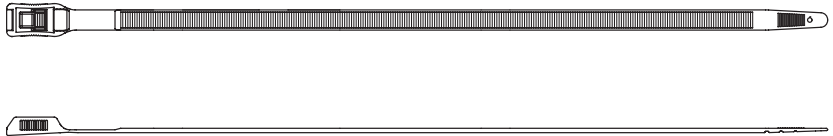

C1. Wiring Duct

C2. Surface Raceway

C3. Abrasion Protection

C4. Cable Management

Part Number	Length		Width		Thickness		Max. Bundle Dia.		Min. Loop Tensile Strength		Recommended Installation Tool	Std. Pkg. Qty.	Std. Ctn. Qty.
	In.	mm	In.	mm	In.	mm	In.	mm	Lbs.	N			
HV965-C0	10.4	265	.350	8.9	.076	1.9	2.60	65	160	710	GTH, GS4H, GS4EH, PTH, STH2, ST3EH, STHV	100	1000
HV9100-C0	14.4	367	.350	8.9	.076	1.9	3.90	100	160	710		100	1000
HV9150-C0	20.7	525	.350	8.9	.076	1.9	5.90	150	160	710		100	1000
HV9250-C0	33.1	841	.350	8.9	.076	1.9	9.80	250	160	710		100	1000

D1. Terminals

D2. Power Connectors

D3. Grounding Connectors



HYPER-V™ Cable Tie Mounts

- Tie mount has retaining tab within window to hold cable tie in position when pre-installed in the mount; low profile design keeps bundle close to mounting surface
- Masonry mounts are used to secure wire, cable, or tubing to masonry surfaces
- For outdoor use



HVTM

HVMPM

E1. Labeling Systems

E2. Labels

E3. Pre-Printed & Write-On Markers

E4. Permanent Identification

E5. Lockout/Tagout & Safety Solutions

F. Index

Part Number	Material	Color	Mounting Method	Std. Pkg. Qty.	Std. Ctn. Qty.
Tie Mounts					
HVTM3S10-C0	Weather Resistant Nylon 6.6	Black	#10 (6mm) screw	100	500
Masonry Mounts					
HVMPM32-C0	Impact Modified Weather Resistant Nylon 6.6	Black	Tree barb for .31" (7.9mm) hole diameter	100	500

Note: UL Recognized except HVTM mount.

IN-LINE Cable Ties – Weather Resistant Nylon 6.6

- Greater resistance to damage caused by ultraviolet light – indoor or outdoor use
- Parallel-entry cable tie that threads like a belt (180° entry)
- Wide tie body provides high tensile strength
- 50% lower head height than conventional 90° ties
- Parallel-entry limits exposure to sharp edges and protects workers' arms/hands
- Outside teeth protect cable jacket and wire insulation
- “Finger grip” shaped head with serrations assures positive grip while threading tie
- Install by hand or use *PANDUIT* GTH installation tool, see page B1.109
- Flexible – easy to handle and install
- Available in UV weather resistant colors for color coordination and UV stability

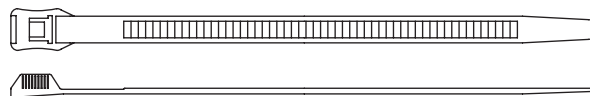

Part Number	Color	Length		Width		Thickness		Max. Bundle Dia.		Min. Loop Tensile Str.		Std. Pkg. Qty	Std. Ctn. Qty.
		In.	mm	In.	mm	In.	mm	In.	mm	Lbs.	N		
Black Cable Ties													
IT940-C0	UV Black	6.8	173	.350	8.9	.065	1.7	1.57	40	124	552	100	1000
IT965-C0	UV Black	10.1	257	.350	8.9	.065	1.7	2.56	65	124	552	100	1000
IT9100-C0	UV Black	14.1	358	.350	8.9	.065	1.7	3.94	100	124	552	100	1000
IT9115-C0	UV Black	15.3	389	.350	8.9	.065	1.7	4.53	115	124	552	100	1000
Colored Cable Ties													
IT9100-CUV2	UV Red	14.1	358	.350	8.9	.065	1.7	3.94	100	124	552	100	1000
IT9100-CUV4Y	UV Yellow	14.1	358	.350	8.9	.065	1.7	3.94	100	124	552	100	1000
IT9100-CUV6	UV Dark Blue	14.1	358	.350	8.9	.065	1.7	3.94	100	124	552	100	1000
IT9100-CUV6A	UV Light Blue	14.1	358	.350	8.9	.065	1.7	3.94	100	124	552	100	1000
IT9100-CUV7A	UV Purple	14.1	358	.350	8.9	.065	1.7	3.94	100	124	552	100	1000
IT9100-CUV8	UV Silver	14.1	358	.350	8.9	.065	1.7	3.94	100	124	552	100	1000
IT9100-CUV16B	UV Magenta	14.1	358	.350	8.9	.065	1.7	3.94	100	124	552	100	1000
IT9115-CUV2	UV Red	15.3	389	.350	8.9	.065	1.7	4.53	115	124	552	100	1000
IT9115-CUV2A	UV Bright Red	15.3	389	.350	8.9	.065	1.7	4.53	115	124	552	100	1000
IT9115-CUV4Y	UV Yellow	15.3	389	.350	8.9	.065	1.7	4.53	115	124	552	100	1000
IT9115-CUV4A	UV Butterscotch	15.3	389	.350	8.9	.065	1.7	4.53	115	124	552	100	1000
IT9115-CUV5A	UV Green	15.3	389	.350	8.9	.065	1.7	4.53	115	124	552	100	1000
IT9115-CUV5B	UV Hunter Green	15.3	389	.350	8.9	.065	1.7	4.53	115	124	552	100	1000
IT9115-CUV6	UV Dark Blue	15.3	389	.350	8.9	.065	1.7	4.53	115	124	552	100	1000
IT9115-CUV6A	UV Light Blue	15.3	389	.350	8.9	.065	1.7	4.53	115	124	552	100	1000
IT9115-CUV6B	UV Cobalt Blue	15.3	389	.350	8.9	.065	1.7	4.53	115	124	552	100	1000
IT9115-CUV7A	UV Purple	15.3	389	.350	8.9	.065	1.7	4.53	115	124	552	100	1000
IT9115-CUV8	UV Gray	15.3	389	.350	8.9	.065	1.7	4.53	115	124	552	100	1000
IT9115-CUV11	UV Teal	15.3	389	.350	8.9	.065	1.7	4.53	115	124	552	100	1000
IT9115-CUV16B	UV Magenta	15.3	389	.350	8.9	.065	1.7	4.53	115	124	552	100	1000
IT9115-CUV18	UV Tan	15.3	389	.350	8.9	.065	1.7	4.53	115	124	552	100	1000

A.
System
Overview

B1.
Cable Ties

B2.
Cable
Accessories

B3.
Stainless
Steel Ties

C1.
Wiring
Duct

C2.
Surface
Raceway

C3.
Abrasion
Protection

C4.
Cable
Management

D1.
Terminals

D2.
Power
Connectors

D3.
Grounding
Connectors

E1.
Labeling
Systems

E2.
Labels

E3.
Pre-Printed
& Write-On
Markers

E4.
Permanent
Identification

E5.
Lockout/
Tagout/
& Safety
Solutions

F.
Index

A.
System
Overview

Parallel-Entry Cable Ties

B1.
Cable Ties

Material and Color Chart

Material	Color	PANDUIT Suffix	Material	Color	PANDUIT Suffix
Nylon 6.6	Natural	✓	Nylon 6.6	Ultraviolet Red	UV2
Weather Resistant Nylon 6.6	Black	0	Nylon 6.6	Ultraviolet Bright Red	UV2A
Nylon 6.6	Brown	1	Nylon 6.6	Ultraviolet Yellow	UV4Y
Nylon 6.6	Red	2	Nylon 6.6	Ultraviolet Butterscotch	UV4A
Nylon 6.6	Orange	3	Nylon 6.6	Ultraviolet Green	UV5A
Nylon 6.6	Yellow	4Y	Nylon 6.6	Ultraviolet Hunter Green	UV5B
Nylon 6.6	Green	5	Nylon 6.6	Ultraviolet Dark Blue	UV6
Nylon 6.6	Blue	6	Nylon 6.6	Ultraviolet Light Blue	UV6A
Nylon 6.6	Purple	7	Nylon 6.6	Ultraviolet Cobalt Blue	UV6B
Nylon 6.6	Gray	8	Nylon 6.6	Ultraviolet Purple	UV7A
Nylon 6.6	White	10	Nylon 6.6	Ultraviolet Gray	UV8
Heat Stabilized Nylon 6.6	Black	30	Nylon 6.6	Ultraviolet Teal	UV11
Heat Stabilized Nylon 6.6	Natural	39	Nylon 6.6	Ultraviolet Magenta	UV16B
Flame Retardant Nylon 6.6	Natural (Ivory)	69	Nylon 6.6	Ultraviolet Tan	UV18

✓Denotes PANDUIT Natural Nylon 6.6 (no suffix).

B2.
Cable
Accessories

B3.
Stainless
Steel Ties

C1.
Wiring
Duct

C2.
Surface
Raceway

C3.
Abrasion
Protection

Part Number Availability List

Part Number	Standard Packaging		Part Number	Bulk Packaging	
	Natural Nylon 6.6	Material/Color (Suffix)		Natural Nylon 6.6	Material/Color (Suffix)
			CBR1M-M	✓	0,30
			CBR1.5M-M	✓	0
			CBR2M-M	✓	0,1,2,3,4Y,5,6,7
			CBR1.5I-M	✓	0,30
			CBR3I-M	✓	0,1,2,3,4Y,5,6,7,8,10
			CBR4I-M	✓	0
			CBR2S-M	✓	0,30,39
			CBR3S-M	✓	0,30,69
			CBR4S-M	✓	0,30
			CBR2HS-D	✓	0
			CBR4LH-TL	✓	0,30
			CBR6LH-C	✓	0,30
			HV965-C		0
			HV9100-C		0
			HV9150-C		0
			HV9250-C		0
ILT2S-C	✓	0	ILT2S-M	✓	0
ILT3S-C	✓	0	ILT3S-M	✓	0
ILT4S-C	✓	0	ILT4S-M	✓	0
			ILT4LH-TL	✓	0
			ILT6LH-C	✓	0
			IT940-C		0
			IT965-C		0
			IT9100-C		0,UV2,UV4Y,UV6,UV6A,UV7A,UV8,UV16B
			IT9115-C		0,UV2,UV2A,UV4Y,UV4A,UV5A,UV5B,UV6,UV6A,UV6B,UV7A,UV8,UV11,UV16B,UV18

C4.
Cable
Management

D1.
Terminals

D2.
Power
Connectors

D3.
Grounding
Connectors

E1.
Labeling
Systems

E2.
Labels

E3.
Pre-Printed
& Write-On
Markers

E4.
Permanent
Identification

E5.
Lockout/
Tagout
& Safety
Solutions

F.
Index

Features and Benefits – STA-STRAP® Cable Ties

Two-piece design incorporates a separate nylon head and strap.

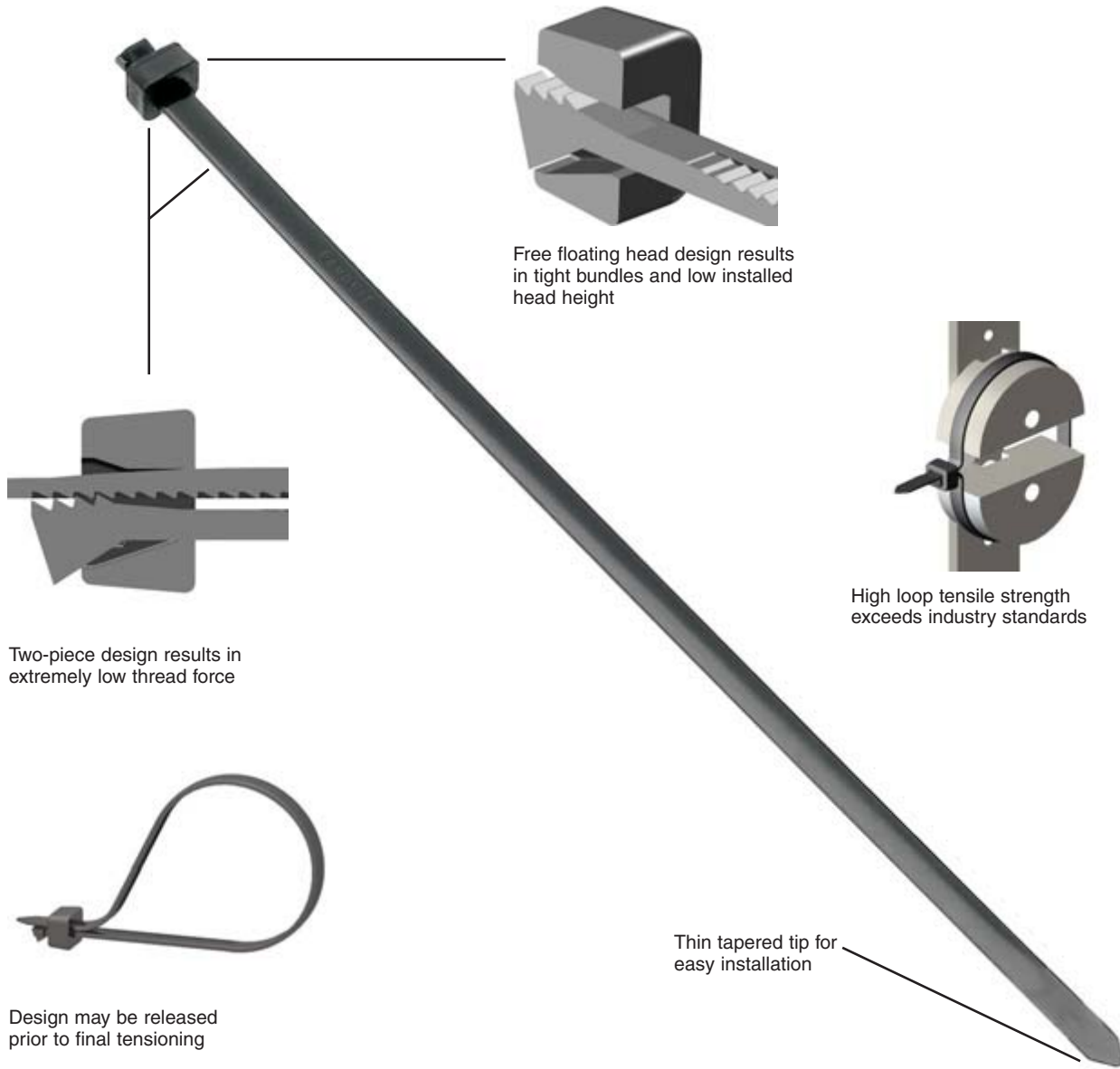

Free floating head design results in tight bundles and low installed head height

Two-piece design results in extremely low thread force

High loop tensile strength exceeds industry standards

Thin tapered tip for easy installation

Design may be released prior to final tensioning



Cable tie tools speed installation and reduce total installed cost. See pages B1.107 – B1.112.



Cable tie accessories are used to speed and simplify the mounting of wires, cables, and tubing. See pages B2.1 – B2.29.

A. System Overview

B1. Cable Ties

B2. Cable Accessories

B3. Stainless Steel Ties

C1. Wiring Duct

C2. Surface Raceway

C3. Abrasion Protection

C4. Cable Management

D1. Terminals

D2. Power Connectors

D3. Grounding Connectors

E1. Labeling Systems

E2. Labels

E3. Pre-Printed & Write-On Markers

E4. Permanent Identification

E5. Lockout/Tagout & Safety Solutions

F. Index

A.
System
Overview

Selection Guide – STA-STRAP® Cable Ties

B1.
Cable Ties



B2.
Cable
Accessories

B3.
Stainless
Steel Ties

C1.
Wiring
Duct

C2.
Surface
Raceway

C3.
Abrasion
Protection

C4.
Cable
Management

D1.
Terminals

D2.
Power
Connectors

D3.
Grounding
Connectors

E1.
Labeling
Systems

E2.
Labels

E3.
Pre-Printed
& Write-On
Markers

E4.
Permanent
Identification

E5.
Lockout/
Tagout/
& Safety
Solutions

F.
Index

Material, Color (Suffix)	Style/Function	Part Number Prefix	Catalog Page
Nylon 6.6, Natural (No Suffix)	Locking Ties/Bundle	SST	B1.67
	Clamp Ties/Mount	SSC	B1.70
	Marker Ties/Identify	SSM	B1.71
Weather Resistant Nylon 6.6, Black (0)	Locking Ties/Bundle	SST	B1.68
	Clamp Ties/Mount	SSC	B1.70
	Marker Ties/Identify	SSM	B1.71
Heat Stabilized Nylon 6.6, Black (30)	Locking Ties/Bundle	SST	B1.69
	Clamp Ties/Mount	SSC	B1.70

Part Number System for STA-STRAP® Cable Ties

SST	1	M		C	
Type	Size	Cross Section	Screw Hole Size	Package Size	Material/Color
SST = Locking Tie SSC = Clamp Tie SSM = Marker Tie	Approx. Maximum Bundle Dia. (In.)	M = Miniature I = Intermediate S = Standard H = Heavy HH = Heavy Head	(Clamp Ties Only) -S6 = #6 (M3) -S10 = #10 (M5) -S25 = 1/4 (M6)	L = 50 C = 100 D = 500 M = 1000	See Page B1.72

UL® CS® STA-STRAP® Cable Ties – Nylon 6.6

- For indoor use
- Used for normal bundling and through-panel applications
- Small head height allows more efficient use of space in compact areas

- Exclusive two-piece design offers the lowest threading force in the industry
- Average 14% lighter than one-piece cable ties
- Releasable prior to final tensioning for bundle modifications



Part Number	Length		Width		Thickness		Max. Bundle Dia.		Min. Loop Tensile Str.		Recommended Installation Tool	Std. Pkg. Qty.	Std. Ctn. Qty.
	In.	mm	In.	mm	In.	mm	In.	mm	Lbs.	N			
Miniature Cross Section													
SST1M-C	4.0	102	.095	2.4	.035	.9	.78	20	18	80	GTS, GTSL, GS2B, PTS, PPTS, STS2	100	1000
SST1.5M-C	5.5	140	.095	2.4	.037	.9	1.25	32	18	80		100	1000
Intermediate Cross Section													
SST1.5I-C	5.3	137	.135	3.4	.037	.9	1.25	32	40	178	GTS, GTSL, GS2B, PTS, PPTS, STS2	100	1000
SST2I-C	8.1	206	.135	3.4	.040	1.0	2.00	51	40	178		100	1000
SST3I-C	11.0	279	.135	3.4	.040	1.0	3.00	76	40	178		100	1000
SST4I-C	14.7	375	.135	3.4	.040	1.0	4.00	102	40	178		100	1000
Standard Cross Section													
SST1.5S-M	5.7	146	.180	4.6	.045	1.2	1.25	32	50	222	GTS, GTSL, GS2B, GTH, GS4H, PTS, PTH, PPTS, STS2, STH2	1000	25000
SST2S-C	6.7	172	.180	4.6	.045	1.2	1.75	45	50	222		100	1000
SST3S-C	11.0	279	.180	4.6	.048	1.2	3.00	76	50	222		100	1000
SST4S-C	15.0	381	.180	4.6	.048	1.2	4.00	102	50	222		100	1000
Light-Heavy Cross Section													
SST2H-D	8.0	203	.300	7.6	.062	1.6	2.00	51	120	534	GTH, GS4H, GS4EH, PTH, STH2, ST3EH	500	5000
SST4H-L	14.8	376	.300	7.6	.067	1.7	4.00	102	120	534		50	500
SST8H-L	27.5	699	.300	7.6	.067	1.7	8.00	203	120	534		50	500

A. System Overview

B1. Cable Ties

B2. Cable Accessories

B3. Stainless Steel Ties

C1. Wiring Duct

C2. Surface Raceway

C3. Abrasion Protection

C4. Cable Management

D1. Terminals

D2. Power Connectors

D3. Grounding Connectors

E1. Labeling Systems

E2. Labels

E3. Pre-Printed & Write-On Markers

E4. Permanent Identification

E5. Lockout/Tagout & Safety Solutions

F. Index

A.
System
Overview

B1.
Cable Ties

B2.
Cable
Accessories

B3.
Stainless
Steel Ties

C1.
Wiring
Duct

C2.
Surface
Raceway

C3.
Abrasion
Protection

C4.
Cable
Management

D1.
Terminals

D2.
Power
Connectors

D3.
Grounding
Connectors

E1.
Labeling
Systems

E2.
Labels

E3.
Pre-Printed
& Write-On
Markers

E4.
Permanent
Identification

E5.
Lockout/
Tagout/
& Safety
Solutions

F.
Index

UL US CSA STA-STRAP® Cable Ties – Weather Resistant Nylon 6.6

- Greater resistance to damage caused by ultraviolet light – indoor or outdoor use
- Used for normal bundling and through-panel applications
- Small head height allows more efficient use of space in compact areas
- Exclusive two-piece design offers the lowest threading force in the industry
- Average 14% lighter than one-piece cable ties
- Releasable prior to final tensioning for bundle modifications

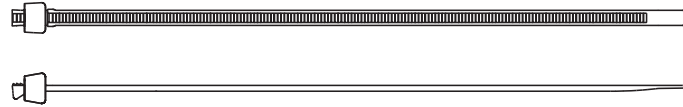

Part Number	Length		Width		Thickness		Max. Bundle Dia.		Min. Loop Tensile Str.		Recommended Installation Tool	Std. Pkg. Qty.	Std. Ctn. Qty.
	In.	mm	In.	mm	In.	mm	In.	mm	Lbs.	N			
Miniature Cross Section													
SST1M-C0	4.0	102	.095	2.4	.035	.9	.78	20	18	80	GTS, GTSL, GS2B, PTS, PPTS, STS2	100	1000
SST1.5M-M0	5.5	140	.095	2.4	.037	.9	1.25	32	18	80		1000	50000
Intermediate Cross Section													
SST1.5I-M0	5.3	137	.135	3.4	.037	.9	1.25	32	40	178	GTS, GTSL, GS2B, PTS, PPTS, STS2	1000	25000
SST2I-M0	8.1	206	.135	3.4	.040	1.0	2.00	51	40	178		1000	25000
SST3I-C0	11.0	279	.135	3.4	.040	1.0	3.00	76	40	178		100	1000
SST4I-M0	14.7	375	.135	3.4	.040	1.0	4.00	102	40	178		1000	10000
Standard Cross Section													
SST1.5S-M0	5.7	146	.180	4.6	.045	1.2	1.25	32	50	222	GTS, GTSL, GS2B, GTH, GS4H, PTS, PTH, PPTS, STS2, STH2	1000	25000
SST2S-C0	6.7	172	.180	4.6	.045	1.2	1.75	45	50	222		100	1000
SST3S-C0	11.0	279	.180	4.6	.048	1.2	3.00	76	50	222		100	1000
SST4S-C0	15.0	381	.180	4.6	.048	1.2	4.00	102	50	222		100	1000
Light-Heavy Cross Section													
SST2H-D0	8.0	203	.300	7.6	.062	1.6	2.00	51	120	534	GTH, GS4H, GS4EH, PTH, STH2, ST3EH	500	5000
SST4H-L0	14.8	376	.300	7.6	.067	1.7	4.00	102	120	534		50	500
SST8H-L0	27.5	699	.300	7.6	.067	1.7	8.00	203	120	534		50	500

UL[®] US CS[®] STA-STRAP® Cable Ties – Heat Stabilized Nylon 6.6

- For high temperature applications up to 239°F (115°C) – indoor use
- Used for normal bundling and through-panel applications
- *Heavy head* design is available for use in through-panel applications with a larger opening up to .400" (10.2mm)
- Small head height allows more efficient use of space in compact areas

- Exclusive two-piece design offers the lowest threading force in the industry
- Average 14% lighter than one-piece cable ties
- Releasable prior to final tensioning for bundle modifications



SST

SST2HH

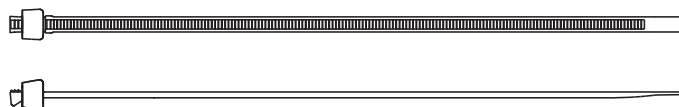

Part Number	Length		Width		Thickness		Max. Bundle Dia.		Min. Loop Tensile Str.		Recommended Installation Tool	Std. Pkg. Qty.	Std. Ctn. Qty.
	In.	mm	In.	mm	In.	mm	In.	mm	Lbs.	N			
Miniature Cross Section													
SST1M-M30	4.0	102	.095	2.4	.035	.9	.78	20	18	80	GTS, GTSL, GS2B, PTS, PPTS, STS2	1000	50000
SST1.5M-M30	5.5	140	.095	2.4	.037	.9	1.25	32	18	80		1000	50000
Standard Cross Section													
SST2S-M30	6.7	172	.180	4.6	.045	1.2	1.75	45	50	222	GTS, GTSL, GS2B, GTH, GS4H, PTS, PTH, PPTS, STS2, STH2	1000	15000
SST3S-M30	11.0	279	.180	4.6	.048	1.2	3.00	76	50	222		1000	10000
SST4S-M30	15.0	381	.180	4.6	.048	1.2	4.00	102	50	222		1000	5000
Light-Heavy Cross Section													
SST4H-D30	14.8	376	.300	7.6	.067	1.7	4.00	102	120	534	GTH, GS4H, GS4EH, PTH, STH2, ST3EH	500	2500
SST8H-D30	27.5	699	.300	7.6	.067	1.7	8.00	203	120	534		500	2000
Heavy Head Design													
Light-Heavy Cross Section													
SST2HH-D30	8.0	203	.300	7.6	.062	1.6	2.00	50	120	534	GTH, GS4H, GS4EH, PTH, STH2, ST3EH	500	2500
SST4HH-D30	14.8	376	.300	7.6	.062	1.6	4.00	102	120	534		500	2500

A. System Overview

B1. Cable Ties

B2. Cable Accessories

B3. Stainless Steel Ties

C1. Wiring Duct

C2. Surface Raceway

C3. Abrasion Protection

C4. Cable Management

D1. Terminals

D2. Power Connectors

D3. Grounding Connectors

E1. Labeling Systems

E2. Labels

E3. Pre-Printed & Write-On Markers

E4. Permanent Identification

E5. Lockout/Tagout & Safety Solutions

F. Index

A.
System
Overview

STA-STRAP® Clamp Ties

B1.
Cable Ties

- Natural nylon material for indoor use
- Weather resistant material has greater resistance to damage caused by ultraviolet light – indoor or outdoor use
- Heat stabilized material for high temperature applications up to 239°F (115°C) – indoor use
- Design allows for bundling before or after screwing clamp in place

- Exclusive two-piece design offers the lowest threading force in the industry
- Used to secure a cable bundle to another surface such as a control panel, communication rack, wall or ceiling
- Only clamp tie that is releasable prior to final tensioning

B2.
Cable
Accessories



SSC2S-S10-C

SSC2S-S10-M0

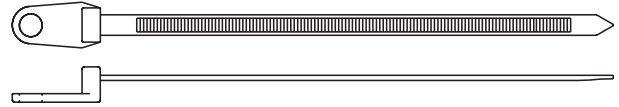

B3.
Stainless
Steel Ties

C1.
Wiring
Duct

C2.
Surface
Raceway

Part Number	Length		Width		Thickness		Nominal Hole Dia.		Screw Size	Metric Screw Size	Max. Bundle Dia.		Min. Loop Tensile Str.		Recommended Installation Tool	Std. Pkg. Qty.	Std. Ctn. Qty.
	In.	mm	In.	mm	In.	mm	In.	mm			In.	mm	Lbs.	N			

C3.
Abrasion
Protection

Nylon 6.6

Standard Cross Section

SSC2S-S6-C	7.4	187	.180	4.6	.045	1.1	.148	3.8	#6	M3	1.75	45	50	222	GTS, GTSL, GS2B, GTH, GS4H, PTS, PTH, PPTS, STS2, STH2	100	1000
SSC2S-S10-C	7.4	187	.180	4.6	.045	1.1	.200	5.1	#10	M5	1.75	45	50	222	GTS, GTSL, GS2B, GTH, GS4H, PTS, PTH, PPTS, STS2, STH2	100	1000
SSC4S-S10-C	15.7	398	.180	4.6	.045	1.1	.200	5.1	#10	M5	4.00	102	50	222	GTS, GTSL, GS2B, GTH, GS4H, PTS, PTH, PPTS, STS2, STH2	100	500

C4.
Cable
Management

Light-Heavy Cross Section

SSC4H-S25-L	15.6	395	.300	7.6	.065	1.7	.260	6.6	1/4	M6	4.00	102	120	534	GTH, GS4H, GS4EH, PTH, STH2, ST3EH	50	500
-------------	------	-----	------	-----	------	-----	------	-----	-----	----	------	-----	-----	-----	------------------------------------	----	-----

D2.
Power
Connectors

Weather Resistant Nylon 6.6

Standard Cross Section

SSC2S-S6-M0	7.4	187	.180	4.6	.045	1.1	.148	3.8	#6	M3	1.75	45	50	222	GTS, GTSL, GS2B, GTH, GS4H, PTS, PTH, PPTS, STS2, STH2	1000	10000
SSC2S-S10-M0	7.4	187	.180	4.6	.045	1.1	.200	5.1	#10	M5	1.75	45	50	222	GTS, GTSL, GS2B, GTH, GS4H, PTS, PTH, PPTS, STS2, STH2	1000	10000
SSC4S-S10-M0	15.7	398	.180	4.6	.045	1.1	.200	5.1	#10	M5	4.00	102	50	222	GTS, GTSL, GS2B, GTH, GS4H, PTS, PTH, PPTS, STS2, STH2	1000	5000

D3.
Grounding
Connectors

Light-Heavy Cross Section

SSC4H-S25-D0	15.6	395	.300	7.6	.065	1.7	.260	6.6	1/4	M6	4.00	102	120	534	GTH, GS4H, GS4EH, PTH, STH2, ST3EH	500	2500
--------------	------	-----	------	-----	------	-----	------	-----	-----	----	------	-----	-----	-----	------------------------------------	-----	------

E1.
Labeling
Systems

Heat Stabilized Nylon 6.6

Standard Cross Section

SSC2S-S10-M30	7.4	187	.180	4.6	.045	1.2	.200	5.1	#10	M5	1.75	45	50	222	GTS, GTSL, GS2B, GTH, GS4H, PTS, PTH, PPTS, STS2, STH2	1000	10000
----------------------	-----	-----	------	-----	------	-----	------	-----	-----	----	------	----	----	-----	--	------	-------

E3.
Pre-Printed
& Write-On
Markers

Light-Heavy Cross Section

SSC4H-S25-D30	15.6	395	.300	7.6	.065	1.7	.260	6.6	1/4	M6	4.00	102	120	534	GTH, GS4H, GS4EH, PTH, STH2, ST3EH	500	2500
---------------	------	-----	------	-----	------	-----	------	-----	-----	----	------	-----	-----	-----	------------------------------------	-----	------

E4.
Permanent
Identification

E5.
Lockout/
Tagout/
& Safety
Solutions

F.
Index

UL[®] US CS[®] STA-STRAP[®] Marker Ties – Nylon and Weather Resistant Nylon 6.6

- Natural nylon material for indoor use
- Weather resistant material has greater resistance to damage caused by ultraviolet light – indoor or outdoor use
- Used to fasten and identify bundles at the same time
- Unique design allows tie to be used as a wrap-around or flag marker

- Can be marked with *PANDUIT* Marker Pens on page B1.51 or computer printable labels
- Custom imprinting with text, symbols, or trademarks available using *PANDUIT* Custom Hot Stamping Service, see page B1.91



SSM2S-C



SSM2S-D0

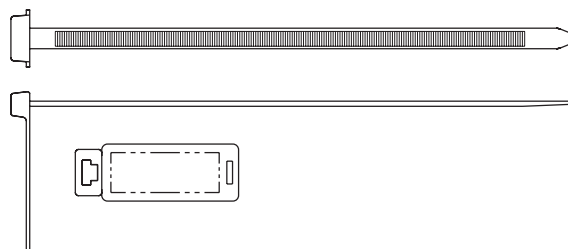

Part Number	Marker Type	Length		Width		Thickness		Marker Write-On Area		Max. Bundle Dia.		Min. Loop Tensile Str.		Recommended Installation Tool	Std. Pkg. Qty.	Std. Ctn. Qty.
		In.	mm	In.	mm	In.	mm	In.	mm	In.	mm	Lbs.	N			

Nylon 6.6

Standard Cross Section

SSM2S-C	Wrap/Flag	6.7	170	.180	4.6	.045	1.1	.44 x .96	11.2 x 24.4	1.75	45	50	222	GTS, GTSL, GS2B, GTH, GS4H, PTS, PTH, PPTS, STS2, STH2	100	500
SSM4S-D	Wrap/Flag	14.9	378	.180	4.6	.045	1.1	.44 x .96	11.2 x 24.4	4.00	102	50	222	GTS, GTSL, GS2B, GTH, GS4H, PTS, PTH, PPTS, STS2, STH2	500	5000

Weather Resistant Nylon 6.6

Standard Cross Section

SSM2S-D0	Wrap/Flag	6.7	170	.180	4.6	.045	1.1	.44 x .96	11.2 x 24.4	1.75	45	50	222	GTS, GTSL, GS2B, GTH, GS4H, PTS, PTH, PPTS, STS2, STH2	500	10000
-----------------	-----------	-----	-----	------	-----	------	-----	-----------	-------------	------	----	----	-----	--	-----	-------

A. System Overview

B1. Cable Ties

B2. Cable Accessories

B3. Stainless Steel Ties

C1. Wiring Duct

C2. Surface Raceway

C3. Abrasion Protection

C4. Cable Management

D1. Terminals

D2. Power Connectors

D3. Grounding Connectors

E1. Labeling Systems

E2. Labels

E3. Pre-Printed & Write-On Markers

E4. Permanent Identification

E5. Lockout/Tagout & Safety Solutions

F. Index

A.
System
Overview

STA-STRAP® Cable Ties

B1.
Cable Ties

Material and Color Chart

Material	Color	PANDUIT Suffix
Nylon 6.6	Natural	✓
Weather Resistant Nylon 6.6	Black	0
Nylon 6.6	Red	2

Material	Color	PANDUIT Suffix
Nylon 6.6	Black	20
Heat Stabilized Nylon 6.6	Black	30

✓Denotes PANDUIT Natural Nylon 6.6 (no suffix).

C1.
Wiring
Duct

C2.
Surface
Raceway

C3.
Abrasion
Protection

Part Number Availability List

Standard Packaging			Bulk Packaging		
Part Number	Natural Nylon 6.6	Material/Color Suffix	Part Number	Natural Nylon 6.6	Material/Color Suffix
SSC2S-S6-C	✓		SSC2S-S6-M	✓	0
SSC2S-S10-C	✓		SSC2S-S10-M	✓	0,30
SSC4S-S10-C	✓		SSC4S-S10-M	✓	0
SSC4H-S25-L	✓		SSC4H-S25-D	✓	0
SSM2S-C	✓		SSM2S-D	✓	0
			SSM4S-D	✓	
SST1M-C	✓	0	SST1M-M	✓	0,20,30
SST1.5M-C	✓		SST1.5M-M	✓	0,20,30
SST1.5I-C	✓		SST1.5I-M	✓	0
SST2I-C	✓		SST2I-M	✓	0
SST3I-C	✓	0	SST3I-M	✓	0
SST4I-C	✓		SST4I-M	✓	0
			SST1.5S-M	✓	0
SST2S-C	✓	0	SST2S-M	✓	0,20,30
SST3S-C	✓	0	SST3S-M	✓	0,20,30
SST4S-C	✓	0	SST4S-M	✓	0,2,30
			SST2H-D	✓	0
			SST2HH-D		30
SST4H-L	✓	0	SST4H-D	✓	0,30
			SST4HH-D		30
SST8H-L	✓	0	SST8H-D	✓	0,30

E3.
Pre-Printed
& Write-On
Markers

E4.
Permanent
Identification

E5.
Lockout/
Tagout/
& Safety
Solutions

F.
Index

Selection Guide – Specialty Ties



	Material, Color (Suffix)	Style/Function	Part Number Prefix	Catalog Page
Stud Mounted Cable Ties	Heat Stabilized Nylon 6.6, Black (30)	Locking Ties/Bundle	PLST	B1.74
		Releasable/Re-usable	PRST	B1.74
	Heat Stabilized Weather Resistant Nylon 6.6, Black (300)	Locking/Bundle	PLST	B1.74
Ladder Style Stud Mount	Heat Stabilized Nylon 6.6, Black (30)	Releasable/Re-usable	PRST	B1.75
Double Loop Ties – One-Piece	Nylon 6.6, Natural (No Suffix)	Locking/Bundle	PLB	B1.76
	Weather Resistant Nylon 6.6, Black (0)			
	Heat Stabilized Nylon 6.6, Black (30)			
Double Loop Ties – Two-Piece	Nylon 6.6, Natural (No Suffix)	Locking/Bundle	SSB	B1.77
	Weather Resistant Nylon 6.6, Black (0)			
	Heat Stabilized Nylon 6.6, Black (30)			
Triple Loop Ties	Weather Resistant Nylon 6.6, Black (0)	Locking/Bundle	PL3B	B1.78
Double Hose Clamp	Weather Resistant Nylon 6.6, Black (0)	Locking/Bundle	DHC	B1.78
Chassis/ Panel Mount Ties	Heat Stabilized Weather Resistant Nylon 6.6, Black (300)	Locking/Bundle	SSPM	B1.79
Cable Marker Strap	Polyethylene (No Suffix)	Releasable/Re-usable	CM4S	B1.80

Part Number System for Specialty Cable Ties

PLST

Type

CM4S = Cable Marker Strap
 PLB = Locking Bow Tie
 PL3B = Triple Loop Tie
 DHC = Double Hose Clamp
 PLST = Locking Stud Mounted Tie
 PRST = Releasable Stud Mount Ladder Style
 SSB = STA-STRAP® BOW-TY™ Tie
 SSPM = STA-STRAP® Panel Mount

4

Size

Approx. Maximum Bundle Dia. (In.)

H

Cross Section

S = Standard
 H = Heavy
 EH = Extra-Heavy

S25

Stud Size

-S25 = M6
 -SC = 5mm
 -S14 = 5mm

—

TL

Package Size

L = 50
 C = 100
 TL = 250
 D = 500
 M = 1000

300

Material/Color

See Page B1.81



Cable tie tools speed installation and reduce total installed cost. See pages B1.107 – B1.112.



Cable tie accessories are used to speed and simplify the mounting of wires, cables, and tubing. See pages B2.1 – B2.29.

A. System Overview

B1. Cable Ties

B2. Cable Accessories

B3. Stainless Steel Ties

C1. Wiring Duct

C2. Surface Raceway

C3. Abrasion Protection

C4. Cable Management

D1. Terminals

D2. Power Connectors

D3. Grounding Connectors

E1. Labeling Systems

E2. Labels

E3. Pre-Printed & Write-On Markers

E4. Permanent Identification

E5. Lockout/Tagout & Safety Solutions

F. Index

A.
System
Overview



PAN-TY® Stud Mounted Cable Ties – Heat Stabilized and Heat Stabilized Weather Resistant Nylon 6.6

B1.
Cable Ties

- Heat stabilized material for high temperature applications up to 239°F (115°C) – indoor use
- Heat stabilized weather resistant material has greater resistance to damage caused by ultraviolet light and for high temperature applications up to 212°F (100°C) – indoor or outdoor use
- Integral mount pushes onto a threaded stud and tie wraps around bundle

- Mid-mount style (PLST_SC) centers the wire bundle over the stud
- Tie can be removed from the stud by turning counterclockwise
- Releasable style available (PRST)
- Curved tip is easy to pick up from flat surfaces and allows faster initial threading to speed installation

B2.
Cable
Accessories

B3.
Stainless
Steel Ties

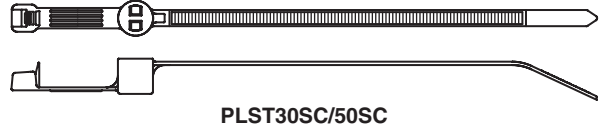

C1.
Wiring
Duct

C2.
Surface
Raceway



C3.
Abrasion
Protection

C4.
Cable
Management



D1.
Terminals

D2.
Power
Connectors

D3.
Grounding
Connectors

Part Number	Length		Width		Thickness		Recommended Stud Size		Max. Bundle Dia.		Min. Loop Tensile Str.		Recommended Installation Tool	Std. Pkg. Qty.	Std. Ctn. Qty.
	In.	mm	In.	mm	In.	mm	In.	mm	In.	mm	Lbs.	N			

Heat Stabilized Nylon 6.6 Standard Cross Section

PLST30SC-D30	5.7	146	.190	4.8	.050	1.3	10-24	5.0	1.18	30	50	222	GTS, GTSL, GS2B, GTH, GS4H, PTS, PTH, PPTS, STS2, STH2	500	5000
PLST50SC-D30	8.1	207	.190	4.8	.050	1.3	10-24	5.0	1.97	50	50	222		500	5000
PRST40SC-D30	6.9	176	.190	4.8	.050	1.3	10-24	5.0	1.57	40	50	222		Hand install only	500

Heat Stabilized Weather Resistant Nylon 6.6 Light-Heavy Cross Section

PLST4HS25-TL300	15.3	389	.300	7.6	.075	1.9	1/4-20	6.4	4.00	102	120	534	GTH, GS4H, GS4EH, PTH, STH2, ST3EH	250	2500
-----------------	------	-----	------	-----	------	-----	--------	-----	------	-----	-----	-----	------------------------------------	-----	------

Note: UL Recognized and CSA Certified except PLST4H.

E5.
Lockout/
Tagout
& Safety
Solutions

F.
Index

UL **CS** **PAN-TY**® Ladder Style Stud Mounted Cable Tie – Heat Stabilized Nylon 6.6

- For high temperature applications up to 239°F (115°C) – indoor use
- Integral mount pushes onto a threaded stud and tie wraps around bundle

- Tie can be removed from the stud by turning counterclockwise
- Adjustable, releasable, and re-usable
- Install by hand – no tools required

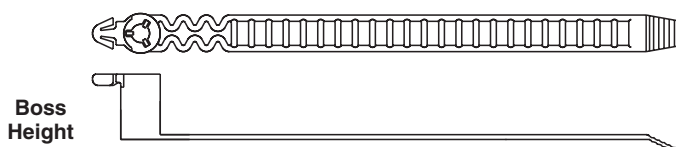

Part Number	Length		Width		Thickness		Boss Height		Recommended Stud Size		Max. Bundle Dia.		Min. Loop Tensile Str.		Std. Pkg. Qty.	Std. Ctn. Qty.
	In.	mm	In.	mm	In.	mm	In.	mm	In.	mm	In.	mm	Lbs.	N		

Standard Cross Section

PRST30S-S14-M30	5.2	132	.380	9.7	.050	1.3	.59	15	10-24	5.0	1.18	30	35	156	1000	10000
-----------------	-----	-----	------	-----	------	-----	-----	----	-------	-----	------	----	----	-----	------	-------

A.
System
Overview

B1.
Cable Ties

B2.
Cable
Accessories

B3.
Stainless
Steel Ties

C1.
Wiring
Duct

C2.
Surface
Raceway

C3.
Abrasion
Protection

C4.
Cable
Management

D1.
Terminals

D2.
Power
Connectors

D3.
Grounding
Connectors

E1.
Labeling
Systems

E2.
Labels

E3.
Pre-Printed
& Write-On
Markers

E4.
Permanent
Identification

E5.
Lockout/
Tagout/
& Safety
Solutions

F.
Index

A. System Overview

B1. Cable Ties

B2. Cable Accessories

B3. Stainless Steel Ties

C1. Wiring Duct

C2. Surface Raceway

C3. Abrasion Protection

C4. Cable Management

D1. Terminals

D2. Power Connectors

D3. Grounding Connectors

E1. Labeling Systems

E2. Labels

E3. Pre-Printed & Write-On Markers

E4. Permanent Identification

E5. Lockout/Tagout & Safety Solutions

F. Index

UL[®] US[®] CS[®] PAN-TY[®] Double Loop Cable Ties

- Natural nylon material for indoor use
- Weather resistant material has greater resistance to damage caused by ultraviolet light – indoor or outdoor use
- Heat Stabilized material for high temperature applications up to 239°F (115°C) – indoor use

- A fast and economical method to secure and separate two bundles
- Reduces part number inventory – single part covers multiple bundle sizes
- Installs easily by hand – second loop can be installed with *PANDUIT* cable tie installation tools



PLB4H
Head Design



PLB2S/3S/4S
Head Design

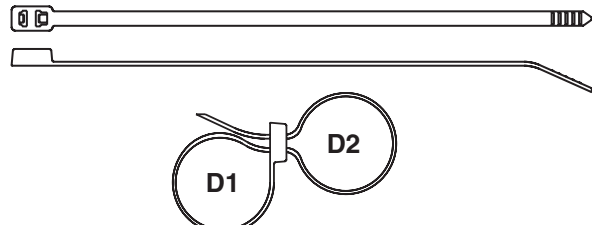

Assembled View

Part Number	Max. Combined Bundle Dia. D1 + D2		Length		Width		Thickness		Min. Loop Tensile Str.		Recommended Installation Tool	Std. Pkg. Qty.	Std. Ctn. Qty.
	In.	mm	In.	mm	In.	mm	In.	mm	Lbs.	N			

Nylon 6.6 Standard Cross Section

PLB2S-C	1.80	46	7.6	193	.190	4.8	.052	1.3	50	222	GTS, GTSL, GS2B, GTH, GS4H, PTS, PTH, PPTS, STS2, STH2	100	1000
PLB3S-C	3.00	76	11.8	300	.190	4.8	.052	1.3	50	222		100	1000
PLB4S-C	4.10	104	14.8	376	.190	4.8	.052	1.3	50	222		100	1000

Light-Heavy Cross Section

PLB4H-TL	3.60	91	14.7	373	.300	7.6	.075	1.9	120	534	GTH, GS4H, GS4EH, PTH, STH2, ST3EH	250	2500
-----------------	------	----	------	-----	------	-----	------	-----	-----	-----	------------------------------------	-----	------

Weather Resistant Nylon 6.6 Standard Cross Section

PLB2S-C0	1.80	46	7.6	193	.190	4.8	.052	1.3	50	222	GTS, GTSL, GS2B, GTH, GS4H, PTS, PTH, PPTS, STS2, STH2	100	1000
PLB3S-C0	3.00	76	11.8	300	.190	4.8	.052	1.3	50	222		100	1000
PLB4S-M0	4.10	104	14.8	376	.190	4.8	.052	1.3	50	222		1000	5000

Light-Heavy Cross Section

PLB4H-TL0	3.60	91	14.7	373	.300	7.6	.075	1.9	120	534	GTH, GS4H, GS4EH, PTH, STH2, ST3EH	250	2500
------------------	------	----	------	-----	------	-----	------	-----	-----	-----	------------------------------------	-----	------

Heat Stabilized Nylon 6.6 Standard Cross Section

PLB2S-M30	1.80	46	7.6	193	.190	4.8	.052	1.3	50	222	GTS, GTSL, GS2B, GTH, GS4H, PTS, PTH, PPTS, STS2, STH2	1000	10000
PLB3S-M30	3.00	76	11.8	300	.190	4.8	.052	1.3	50	222		1000	10000
PLB4S-M30	4.10	104	14.8	376	.190	4.8	.052	1.3	50	222		1000	5000

Light-Heavy Cross Section

PLB4H-TL30	3.60	91	14.7	373	.300	7.6	.075	1.9	120	534	GTH, GS4H, GS4EH, PTH, STH2, ST3EH	250	2500
-------------------	------	----	------	-----	------	-----	------	-----	-----	-----	------------------------------------	-----	------

Note: UL Recognized and CSA Certified except PLB4H-TL0.

UL US CSB US STA-STRAP® BOW-TY™ Cable Ties

- Natural nylon material for indoor use
- Weather resistant material has greater resistance to damage caused by ultraviolet light – indoor or outdoor use
- Heat Stabilized material for high temperature applications up to 239°F (115°C) – indoor use
- A fast and economical method to secure and separate two bundles
- Exclusive two-piece design offers the lowest threading force in the industry
- First loop is releasable prior to final tensing



SSB2S-C



SSB2S-M0 (30)

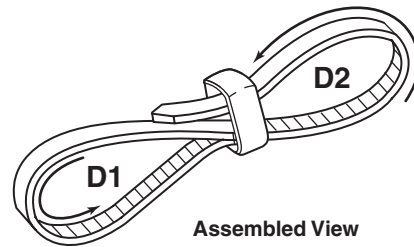
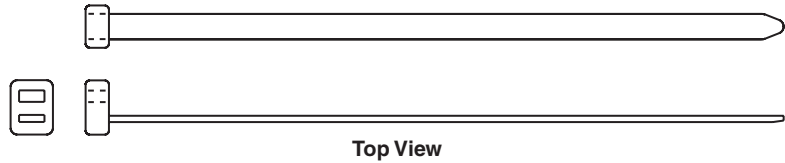

Part Number	Max. Combined Bundle Dia. D1 + D2		Length		Width		Thickness		Min. Loop Tensile Str.		Recommended Installation Tool	Std. Pkg. Qty.	Std. Ctn. Qty.
	In.	mm	In.	mm	In.	mm	In.	mm	Lbs.	N			

Nylon 6.6

Standard Cross Section

SSB2S-C	1.25	32	6.8	172	.18	4.6	.045	1.1	30	133	Hand install only	100	1000
---------	------	----	-----	-----	-----	-----	------	-----	----	-----	-------------------	-----	------

Weather Resistant Nylon 6.6

Standard Cross Section

SSB2S-M0	1.25	32	6.8	172	.18	4.6	.045	1.1	30	133	Hand install only	1000	10000
----------	------	----	-----	-----	-----	-----	------	-----	----	-----	-------------------	------	-------

Heat Stabilized Nylon 6.6

Standard Cross Section

SSB2S-M30	1.25	32	6.8	172	.18	4.6	.045	1.1	30	133	Hand install only	1000	10000
-----------	------	----	-----	-----	-----	-----	------	-----	----	-----	-------------------	------	-------

A. System Overview

B1. Cable Ties

B2. Cable Accessories

B3. Stainless Steel Ties

C1. Wiring Duct

C2. Surface Raceway

C3. Abrasion Protection

C4. Cable Management

D1. Terminals

D2. Power Connectors

D3. Grounding Connectors

E1. Labeling Systems

E2. Labels

E3. Pre-Printed & Write-On Markers

E4. Permanent Identification

E5. Lockout/Tagout & Safety Solutions

F. Index

A. System Overview

PAN-TY® Triple Loop Cable Tie – Weather Resistant Nylon 6.6

B1. Cable Ties

- Greater resistance to damage caused by ultraviolet light – indoor or outdoor use
- A fast and economical method to secure and separate three bundles
- Third loop can be installed with *PANDUIT* cable tie installation tools

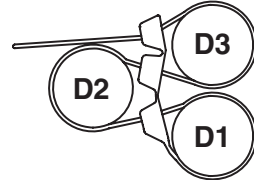
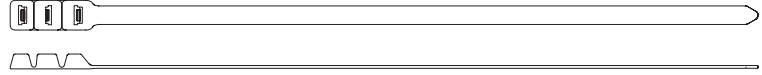

Assembled View

C1. Wiring Duct

C2. Surface Raceway

Part Number	Max. Combined Bundle Dia. D1 + D2 + D3		Length		Width		Thickness		Min. Loop Tensile Str.		Recommended Installation Tool	Std. Pkg. Qty.	Std. Ctn. Qty.
	In.	mm	In.	mm	In.	mm	In.	mm	Lbs.	N			
Extra-Heavy Cross Section													
PL3B5EH-C0	5.00	127	20.0	508	.500	12.7	.075	1.9	125	556	GS4EH, ST3EH	100	1000

C3. Abrasion Protection

C4. Cable Management

Double Hose Clamp – Weather Resistant Nylon 6.6

- Greater resistance to damage caused by ultraviolet light – indoor or outdoor use
- Holds and separates two gasoline, hydraulic, or pneumatic hoses
- Holds each hose individually to prevent abrasion and twisting

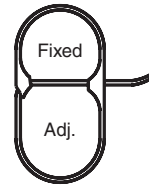
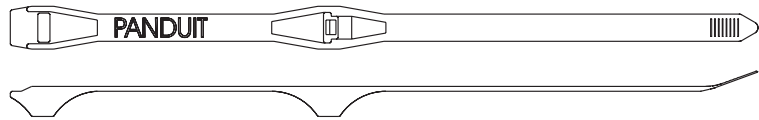

Assembled View

D1. Terminals

D2. Power Connectors

D3. Grounding Connectors

E1. Labeling Systems

Part Number	Length		Width		Thickness		Fixed Loop Dia.		Adjustable Loop Dia.		Min. Loop Tensile Str.		Recommended Installation Tool	Std. Pkg. Qty.	Std. Ctn. Qty.
	In.	mm	In.	mm	In.	mm	In.	mm	In.	mm	Lbs.	N			
DHC1.12X1.75-D0	11.0	279	.280	7.1	.050	1.3	1.12	28	1.00–1.75	25–44	100	445	GTH, GS4H, PTH, STH2, ST3EH	500	2500

E2. Labels

E3. Pre-Printed & Write-On Markers

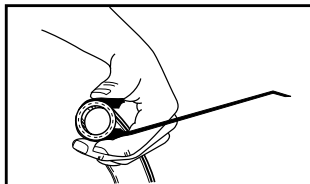

1) Wrap clamp around hose

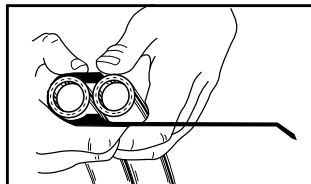

2) Position second hose in clamp

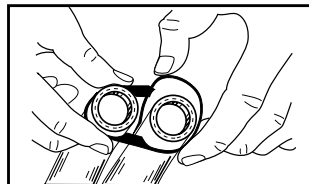

3) Loop tail around second hose and thread tail through both spacer heads

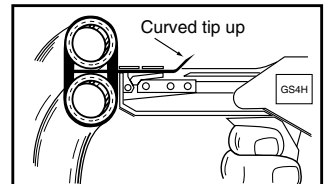

4) Tension and cut off with recommended tool

E4. Permanent Identification

E5. Lockout/Tagout & Safety Solutions

F. Index



STA-STRAP® Chassis/Panel Mount Tie – Heat Stabilized Weather Resistant Nylon 6.6

- Greater resistance to damage caused by ultraviolet light and for high temperature applications up to 212°F (100°C) – indoor or outdoor use
- Unique design allows tie to secure a bundle directly to a chassis or panel without the need for separate fasteners or mounting devices

- Releasable prior to final tensioning for bundle modifications
- Engages clearance hole with optional centering pilot to prevent tie from shifting or abrading in high vibration environments

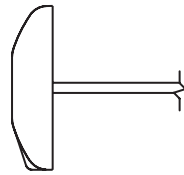
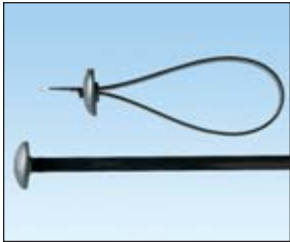

Without Centering Pilot

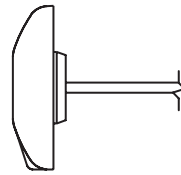

With Centering Pilot

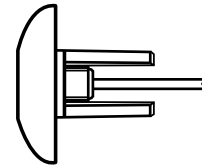

With Long Centering Pilot

Part Number	Length		Width		Thickness		Hole Diameter Range		Max. Bundle Dia.		Min. Loop Tensile Str.		Recommended Installation Tool	Std. Pkg. Qty.	Std. Ctn. Qty.
	In.	mm	In.	mm	In.	mm	In.	mm	In.	mm	Lbs.	N			
Without Centering Pilot															
SSPM2.5H-L300	10.1	257	.300	7.6	.062	1.6	.316 – .820	8.0 – 21.0	2.76	70	120	534	GTH, GS4H, GS4EH, PTH, STH2, ST3EH	50	2500
SSPM4H-L300	14.8	376	.300	7.6	.062	1.6	.316 – .820	8.0 – 21.0	4.00	102	120	534	GTH, GS4H, GS4EH, PTH, STH2, ST3EH	50	2500
With Centering Pilot															
SSPM2.5HP-L300	10.1	257	.300	7.6	.062	1.6	.440 – .820	11.2 – 21.0	2.76	70	120	534	GTH, GS4H, GS4EH, PTH, STH2, ST3EH	50	2500
SSPM4HP-L300	14.8	376	.300	7.6	.062	1.6	.440 – .820	11.2 – 21.0	4.00	102	120	534	GTH, GS4H, GS4EH, PTH, STH2, ST3EH	50	2500
With Long Centering Pilot															
SSPM4HLP-TL300	14.8	376	.300	7.6	.062	1.6	.440 – .820	11.2 – 21.0	4.00	102	120	534	GTH, GS4H, GS4EH, PTH, STH2, ST3EH	250	2500

Through-Panel Mount Installation in Three Easy Steps:

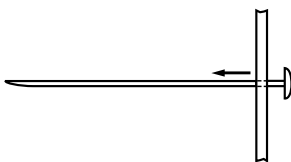

1) Insert tip of cable tie through the pre-drilled hole in the panel.

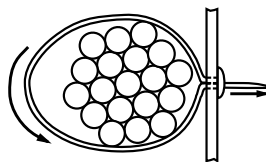

2) Wrap cable tie around the bundle and insert tip back through the hole and head of the cable tie.

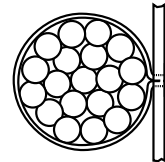

3) Pull tip until cable tie is snug on bundle. Tension and cut off excess portion with installation tool.

A.
System
Overview

Cable Marker Straps – Polyethylene

B1.
Cable Ties

- Identify and code telephone and fiber optic cable
- Eliminate the need for costly and cumbersome lead marking tags
- Lightweight and easy to install
- Use as wrap-around or flag marker

- For underground identification applications
- Can be marked with *PANDUIT* marker pens, see page B1.51
- Custom imprinting with text, symbols, or trademarks available using *PANDUIT* Custom Hot Stamping Service, see page B1.91

B2.
Cable
Accessories

B3.
Stainless
Steel Ties



C1.
Wiring
Duct

C2.
Surface
Raceway

C3.
Abrasion
Protection

C4.
Cable
Management



**Wrap-Around
Marker**
(Min. Dia.: 1.27")

Flag Marker
(Min. Dia.: .25")

D1.
Terminals

D2.
Power
Connectors

D3.
Grounding
Connectors

E1.
Labeling
Systems

E2.
Labels

E3.
Pre-Printed
& Write-On
Markers

E4.
Permanent
Identification

E5.
Lockout/
Tagout/
& Safety
Solutions

F.
Index

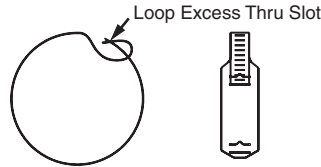
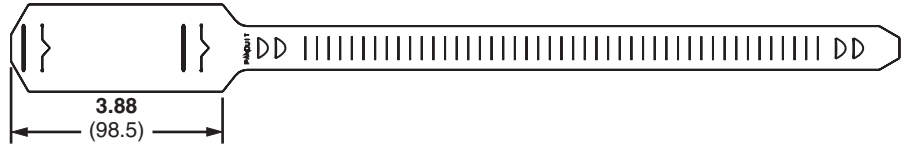

Part Number	Length		Width		Thickness		Color	Marker Write-On Area		Max. Bundle Dia.		Recommended Installation Tool	Std. Pkg. Qty.	Std. Ctn. Qty.
	In.	mm	In.	mm	In.	mm		In.	mm	In.	mm			
Standard Cross Section														
CM4S-L2	15.3	387	.750	19.1	.033	.84	Red	1.50 x 2.62	38.1 x 66.5	4.38	111	Hand install only	50	500
CM4S-L8	15.3	387	.750	19.1	.033	.84	Gray	1.50 x 2.62	38.1 x 66.5	4.38	111		50	500

Specialty Cable Ties

Material and Color Chart

Material	Color	PANDUIT Suffix
Nylon 6.6	Natural	✓
Weather Resistant Nylon 6.6	Black	0
Nylon 6.6	Red	2
Nylon 6.6	Gray	8

Material	Color	PANDUIT Suffix
Heat Stabilized Nylon 6.6	Black	30
Heat Stabilized Weather Resistant Nylon 6.6	Black	300

✓ Denotes PANDUIT Natural Nylon 6.6 (no suffix).

Part Number Availability List

Standard Packaging			Bulk Packaging		
Part Number	Natural Nylon 6.6	Material/Color Suffix	Part Number	Natural Nylon 6.6	Material/Color Suffix
CM4S-L		2,8			
			DHC1.12X1.75-D		0
PLB2S-C	✓	0	PLB2S-M	✓	0,30
PLB3S-C	✓	0	PLB3S-M	✓	0,30
PLB4S-C	✓		PLB4S-M	✓	0,30
			PLB4H-TL	✓	0,30
			PL3B5EH-C		0
			PLST4HS25-TL		300
			PLST30SC-D		30
			PLST50SC-D		30
			PRST30S-S14-M		30
			PRST40SC-SD		30
SSB2S-C	✓		SSB2S-M	✓	0,30
SSPM2.5H-L		300	SSPM2.5H-TL		300
SSPM2.5HP-L		300	SSPM2.5HP-TL		300
SSPM4H-L		300	SSPM4H-TL		300
SSPM4HP-L		300	SSPM4HP-TL		300
			SSPM4HLP-TL		300

A.
System
Overview

B1.
Cable Ties

B2.
Cable
Accessories

B3.
Stainless
Steel Ties

C1.
Wiring
Duct

C2.
Surface
Raceway

C3.
Abrasion
Protection

C4.
Cable
Management

D1.
Terminals

D2.
Power
Connectors

D3.
Grounding
Connectors

E1.
Labeling
Systems

E2.
Labels

E3.
Pre-Printed
& Write-On
Markers

E4.
Permanent
Identification

E5.
Lockout/
Tagout
& Safety
Solutions

F.
Index

A.
System
Overview

UL US CS PAN-TY® Striped Cable Ties – Nylon 6.6

B1.
Cable Ties

- Nylon material for indoor use
- Striped PAN-TY® Cable Ties in 25 color combinations match the universally accepted Even-Count Color Code

- Solid color ties are available for identification of “super groups” in cable containing more than 600 pairs
- Each 50-piece package fits in the PAN-POUCH™ Kit or pocket pouch shown on the next page

B2.
Cable
Accessories



B3.
Stainless
Steel Ties

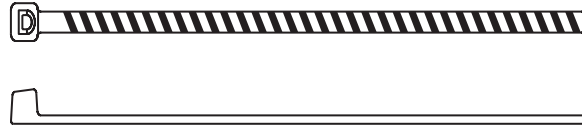

C1.
Wiring
Duct

C2.
Surface
Raceway

C3.
Abrasion
Protection

C4.
Cable
Management

D1.
Terminals

D2.
Power
Connectors

D3.
Grounding
Connectors

E1.
Labeling
Systems

E2.
Labels

E3.
Pre-Printed
& Write-On
Markers

E4.
Permanent
Identification

E5.
Lockout/
Tagout/
& Safety
Solutions

F.
Index

Part Number	Color	Length		Width		Thickness		Max. Bundle Dia.		Min. Loop Tensile Str.		Std. Pkg. Qty.	Std. Ctn. Qty.
		In.	mm	In.	mm	In.	mm	In.	mm	Lbs.	N		
Miniature Cross Section (Straight Tip)													
PLT1M-L6-10	Blue/White Stripe	4.0	102	.100	2.5	.036	.9	.82	21	18	80	50	1000
PLT1M-L3-10	Orange/White Stripe	4.0	102	.100	2.5	.036	.9	.82	21	18	80	50	1000
PLT1M-L5-10	Green/White Stripe	4.0	102	.100	2.5	.036	.9	.82	21	18	80	50	1000
PLT1M-L1-10	Brown/White Stripe	4.0	102	.100	2.5	.036	.9	.82	21	18	80	50	1000
PLT1M-L8-10	Slate/White Stripe	4.0	102	.100	2.5	.036	.9	.82	21	18	80	50	1000
PLT1M-L6-2	Blue/Red Stripe	4.0	102	.100	2.5	.036	.9	.82	21	18	80	50	1000
PLT1M-L3-2	Orange/Red Stripe	4.0	102	.100	2.5	.036	.9	.82	21	18	80	50	1000
PLT1M-L5-2	Green/Red Stripe	4.0	102	.100	2.5	.036	.9	.82	21	18	80	50	1000
PLT1M-L1-2	Brown/Red Stripe	4.0	102	.100	2.5	.036	.9	.82	21	18	80	50	1000
PLT1M-L8-2	Slate/Red Stripe	4.0	102	.100	2.5	.036	.9	.82	21	18	80	50	1000
PLT1M-L6-0	Blue/Black Stripe	4.0	102	.100	2.5	.036	.9	.82	21	18	80	50	1000
PLT1M-L3-0	Orange/Black Stripe	4.0	102	.100	2.5	.036	.9	.82	21	18	80	50	1000
PLT1M-L5-0	Green/Black Stripe	4.0	102	.100	2.5	.036	.9	.82	21	18	80	50	1000
PLT1M-L1-0	Brown/Black Stripe	4.0	102	.100	2.5	.036	.9	.82	21	18	80	50	1000
PLT1M-L8-0	Slate/Black Stripe	4.0	102	.100	2.5	.036	.9	.82	21	18	80	50	1000
PLT1M-L6-4	Blue/Yellow Stripe	4.0	102	.100	2.5	.036	.9	.82	21	18	80	50	1000
PLT1M-L3-4	Orange/Yellow Stripe	4.0	102	.100	2.5	.036	.9	.82	21	18	80	50	1000
PLT1M-L5-4	Green/Yellow Stripe	4.0	102	.100	2.5	.036	.9	.82	21	18	80	50	1000
PLT1M-L1-4	Brown/Yellow Stripe	4.0	102	.100	2.5	.036	.9	.82	21	18	80	50	1000
PLT1M-L8-4	Slate/Yellow Stripe	4.0	102	.100	2.5	.036	.9	.82	21	18	80	50	1000
PLT1M-L6-7	Blue/Violet Stripe	4.0	102	.100	2.5	.036	.9	.82	21	18	80	50	1000
PLT1M-L3-7	Orange/Violet Stripe	4.0	102	.100	2.5	.036	.9	.82	21	18	80	50	1000
PLT1M-L5-7	Green/Violet Stripe	4.0	102	.100	2.5	.036	.9	.82	21	18	80	50	1000
PLT1M-L1-7	Brown/Violet Stripe	4.0	102	.100	2.5	.036	.9	.82	21	18	80	50	1000
PLT1M-L8-7	Slate/Violet Stripe	4.0	102	.100	2.5	.036	.9	.82	21	18	80	50	1000
PLT1M-L0	Black	4.0	102	.100	2.5	.036	.9	.82	21	18	80	50	1000
PLT1M-L1	Brown	4.0	102	.100	2.5	.036	.9	.82	21	18	80	50	1000
PLT1M-L2	Red	4.0	102	.100	2.5	.036	.9	.82	21	18	80	50	1000
PLT1M-L3	Orange	4.0	102	.100	2.5	.036	.9	.82	21	18	80	50	1000
PLT1M-L4Y	Yellow	4.0	102	.100	2.5	.036	.9	.82	21	18	80	50	1000
PLT1M-L5	Green	4.0	102	.100	2.5	.036	.9	.82	21	18	80	50	1000
PLT1M-L6	Blue	4.0	102	.100	2.5	.036	.9	.82	21	18	80	50	1000
PLT1M-L8	Slate	4.0	102	.100	2.5	.036	.9	.82	21	18	80	50	1000

Note: CSA Certified on solid colors only.

Telephone Cable Identification Kits

- *PAN-POUCH™* Kit is made of two-ply laminated black nylon/vinyl and folds for easy storage
- Easily hang pouch from cable by using hook and loop fasteners
- Pocket pouch holds five (50-piece) packages and is made of a white vinyl



PPC25X50F



PP5X50F

Part Number	Description	Dimensions		Std. Pkg. Qty.
		Open	Closed	
PPC25X50F	Pouch filled with 1,250 cable ties (50 each of all 24 striped ties and 50 solid red ties)	10.5" x 38" (267mm x 965mm)	10.5" x 6" (267mm x 152mm)	1
PPC25X50	Empty pouch	10.5" x 38" (267mm x 965mm)	10.5" x 6" (267mm x 152mm)	1
PP5X50F	Pocket pouch filled with 250 cable ties (50 of each color: blue, orange, green, brown and slate – all with white stripe)	—	3.5" x 5.25" (89mm x 133mm)	1

Cable Tie Kits in Steel Boxes



K-205



K-504/SR2

Part Number	Part Description	Std. Pkg. Qty.
K-205	Kit for Indoor Use <i>PAN-TY®</i> Cable Ties, cable tie installation tool, terminals, splices and crimp tool: (1) GTS tool (1) CT-100 crimp tool <u>Natural Nylon 6.6 Cable Ties</u> (100) PLT1M (100) PLT1.5I (100) PLT2S <u>Terminals</u> (100) PV18-6LF (100) PV14-8LF (100) PV14-10LF (50) PV10-10LF <u>Splices</u> (50) BSV10X (100) BSV14X (100) BSV18X	1
K-504	Kit for Indoor Use <i>PAN-TY®</i> Cable Ties, cable tie installation tool, and mounts: (1) STS2 tool <u>Natural Nylon 6.6 Cable Ties</u> (100) PLT1M (100) PLT1.5I (100) PLT2S (100) PLC2S-S10 <u>Mounts</u> (100) TM2S8 (100) ABM2S-A	1
SR2	Two-drawer slide rack to hold K-504 cable tie kit or K-1000 series terminal kit. Dimensions: 6.25"H x 15.25"W x 11.75"D (158.7mm x 387.4mm x 298.5mm)	1

A.
System
Overview

B1.
Cable Ties

B2.
Cable
Accessories

B3.
Stainless
Steel Ties

C1.
Wiring
Duct

C2.
Surface
Raceway

C3.
Abrasion
Protection

C4.
Cable
Management

D1.
Terminals

D2.
Power
Connectors

D3.
Grounding
Connectors

E1.
Labeling
Systems

E2.
Labels

E3.
Pre-Printed
& Write-On
Markers

E4.
Permanent
Identification

E5.
Lockout/
Tagout
& Safety
Solutions

F.
Index

A.
System
Overview

Cable Tie Kits in Plastic Boxes and Bags

B1.
Cable Ties



KP-506A

B2.
Cable
Accessories



KP-506A-0

B3.
Stainless
Steel Ties

C1.
Wiring
Duct

C2.
Surface
Raceway

C3.
Abrasion
Protection

C4.
Cable
Management



KP-509

D1.
Terminals

D2.
Power
Connectors



KB-550

D3.
Grounding
Connectors

E1.
Labeling
Systems



KB-551

E2.
Labels

E3.
Pre-Printed
& Write-On
Markers

E4.
Permanent
Identification

E5.
Lockout/
Tagout/
& Safety
Solutions

F.
Index

Part Number	Part Description	Std. Pkg. Qty.
KP-506A	Kit for Indoor Use <i>PAN-TY</i> ® Cable Ties and Mounts: <u>Natural Nylon 6.6</u> (100) PLT1M (100) PLT1.5I (100) PLT2S (50) ABM2S-A mounts	1
KP-506A-0	Kit for Outdoor Use <i>PAN-TY</i> ® Cable Ties and Mounts: <u>Black Weather Resistant Nylon 6.6</u> (100) PLT1M-0 (100) PLT1.5I-0 (100) PLT2S-0 (50) ABM2S-AT-0 mounts	1
KP-509	Kit for Indoor Use For prototyping and new product development – contains over 600 pcs. <i>PAN-TY</i> ® Cable Ties in different styles, sizes, and colors. Huge assortment of cable tie mounts and wiring accessories.	1
KB-550	Assortment Pack for Indoor and Outdoor Use <i>PAN-TY</i> ® Cable Ties: <u>Natural Nylon 6.6</u> (15) PLT1M (15) PLT1.5I (15) PLT2S (15) PLT3S <u>Black Weather Resistant Nylon 6.6</u> (10) PLT1M-0 (10) PLT1.5I-0 (10) PLT2S-0 (10) PLT3S-0	1
KB-551	Assortment Pack for Indoor and Outdoor Use <i>DOME-TOP</i> ® Barb Ty Cable Ties: <u>Natural Nylon 6.6</u> (15) BT1M (15) BT1.5I (15) BT2S (15) BT3S <u>Black Weather Resistant Nylon 6.6</u> (10) BT1M-0 (10) BT1.5I-0 (10) BT2S-0 (10) BT3S-0	1

Features and Benefits – Hook and Loop Cable Ties

The comprehensive family of hook and loop cable ties delivers reliability by protecting against over-tensioning of high performance fiber and copper cables. These ties are adjustable, releasable, and re-usable to effectively support frequent moves, adds, and changes (MACs). A wide range of colors provides flexibility and an aesthetically pleasing appearance. The complete line of *PANDUIT* Hook and Loop Cable Ties help maintain the reliable, scalable, and aesthetic requirements of data centers.

TAK-TY® Hook & Loop Cable Ties – Premium, durable designs and sizes

Loop Style



Allows for pre-wrapping of bundles

Roll/Strip Style



Available in continuous or perforated rolls

Plenum-Rated



Distinctive maroon color (also available in black)

TAK-TAPE™ Hook & Loop Rolls



Strong, low profile hook and loop material

Convenient packaging



ULTRA-CINCH™ Hook & Loop Cable Ties



Unique same-sided material secures a greater range of bundle diameters

Available in three styles and eight colors; grommet styles used for bundle mounting applications

Low profile contoured cinch ring reduces overall bundle size



Wire management accessories speed and simplify the mounting of high performance cabling.

See pages B2.2, B2.3, B2.10, B2.20, B2.21, B2.24, C4.8 and C4.11

A. System Overview

B1. Cable Ties

B2. Cable Accessories

B3. Stainless Steel Ties

C1. Wiring Duct

C2. Surface Raceway

C3. Abrasion Protection

C4. Cable Management

D1. Terminals

D2. Power Connectors

D3. Grounding Connectors

E1. Labeling Systems

E2. Labels

E3. Pre-Printed & Write-On Markers

E4. Permanent Identification

E5. Lockout/Tagout & Safety Solutions

F. Index

A.
System
Overview

Selection Guide – Hook and Loop Cable Ties

B1.
Cable Ties



B2.
Cable
Accessories

B3.
Stainless
Steel Ties

C1.
Wiring
Duct

Product, Color (Suffix)	Style/Function	Part Number Prefix	Catalog Page
-------------------------	----------------	--------------------	--------------

C2.
Surface
Raceway

TAK-TY® Ties, Black (0)	Loop Ties/Re-usable	HLT	B1.87
	Strip Ties/Re-usable	HLS	B1.87
	15' and 75' Rolls/Re-usable	HLM, HLS	B1.87

C3.
Abrasion
Protection

TAK-TY® Plenum-Rated Ties, UL Listed Black, Maroon (0, 12)	Loop Ties/Re-usable	HLTP	B1.88
	Strip Ties/Re-usable	HLSP	B1.88

C4.
Cable
Management

TAK-TAPE™ Rolls, Black (0)	20' and 35' Rolls/Re-usable	TTS	B1.88
----------------------------	-----------------------------	-----	-------

D1.
Terminals

ULTRA-CINCH™ Ties, Black (0)	Cinch Ties/Re-usable	UCT	B1.89
	Cinch Ties – Center Mount Grommet/Re-usable	UGCTC	B1.89
	Cinch Ties – End Mount Grommet/Re-usable	UGCTE	B1.89

D2.
Power
Connectors

D3.
Grounding
Connectors

E1.
Labeling
Systems

Part Number System for Hook and Loop Ties

E2.
Labels

HLT

2

I

–

X

0

E3.
Pre-Printed
& Write-On
Markers

Type

Size

Cross Section

Package Size

Color

E4.
Permanent
Identification

HL = Hook and Loop
 HLM = HL Miniature
 HLT = HL Loop Tie
 HLTP = HL Loop Tie Plenum-Rated
 HLS = HL Strip Tie
 HLSP = HL Strip Tie Plenum-Rated
 TTS = TAK-TAPE™ Roll
 UCT = ULTRA-CINCH™ Tie
 UGCTC = UCT Grommet Cinch Tie – Center Mount
 UGCTE = UCT Grommet Cinch Tie – End Mount

Approx.
Maximum
Bundle
Dia. (In.)

I = Intermediate
 S = Standard

X = 10
 15R = 15' Roll
 20R = 20' Roll
 35R3 = 35' Rolls (3)
 35RX = 35' Rolls (10)
 75R = 75' Roll

See page
B1.90

E5.
Lockout/
Tagout/
& Safety
Solutions

F.
Index

TAK-TY® Hook & Loop Cable Ties

- Soft, premium material is safe to use on high performance cabling protecting against over-tensioning
- Broadest selection of durable designs and sizes to meet your application needs
- Adjustable, releasable, and re-usable multiple times – ideal for applications requiring frequent moves, adds, or changes

- A full range of colors
- Operating temperature range: 0°F to 220°F (-18°C to 104°C)
- Complementary mounts available, see page B2.10

Note: Minimum 2" overlap required to achieve loop tensile rating.



HLT (Loop Ties)



HLS (Strip Ties)



HLM/HLS (Rolls)



X-out for #10 screw
(Recommend truss head)

Part Number	Length		Width		Max. Bundle Dia.		Min. Loop Tensile Str.		Std. Pkg. Qty.	Std. Ctn. Qty.
	In.	mm	In.	mm	In.	mm	Lbs.	N		
Loop Ties – Slot allows for pre-wrapping of bundles										
HLT2I-X0	8.0	203	.500	12.7	1.91	49	40	178	10	100
HLT3I-X0	12.0	305	.500	12.7	3.18	81	40	178	10	100
Strip Ties – Perforated in convenient 6", 12", and 18" strips										
HLS1.5S-X0	6.0	152	.750	19.1	1.50	38	50	222	10	100
HLS3S-X0	12.0	305	.750	19.1	3.20	81	50	222	10	100
HLS5S-X0	18.0	457	.750	19.1	5.00	127	50	222	10	100

Part Number	Length		Width		Max. Bundle Dia.		Min. Loop Tensile Str.		Std. Pkg. Qty.	Std. Ctn. Qty.
	Ft.	m	In.	mm	In.	mm	Lbs.	N		
15' and 75' Continuous Rolls – Can be cut to desired length, eliminating waste										
HLM-15R0	15.0	4.6	.330	8.4	Various	Various	18	80	1	10
HLS-15R0	15.0	4.6	.750	19.1	Various	Various	50	222	1	10
HLS-75R0	75.0	22.9	.750	19.1	Various	Various	50	222	1	10

A.
System
Overview

B1.
Cable Ties

B2.
Cable
Accessories

B3.
Stainless
Steel Ties

C1.
Wiring
Duct

C2.
Surface
Raceway

C3.
Abrasion
Protection

C4.
Cable
Management

D1.
Terminals

D2.
Power
Connectors

D3.
Grounding
Connectors

E1.
Labeling
Systems

E2.
Labels

E3.
Pre-Printed
& Write-On
Markers

E4.
Permanent
Identification

E5.
Lockout/
Tagout
& Safety
Solutions

F.
Index

A. System Overview



TAK-TY® Hook & Loop Cable Ties – Plenum-Rated

- Soft, premium material is safe to use on high performance cabling protecting against over-tensioning
- UL Listed for use in plenum or air handling spaces (such as ceiling voids and underfloor areas) per NEC, Section 300-22 (C) and (D)
- Flammability rating: UL 94V-2

- Adjustable, releasable, and re-usable multiple times – ideal for applications requiring frequent moves, adds, or changes
- Operating temperature range: 0°F to 122°F (-18°C to 50°C)

Note: Minimum 2" overlap required to achieve loop tensile rating.

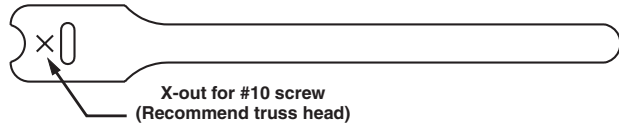

B1. Cable Ties

B2. Cable Accessories

B3. Stainless Steel Ties

C1. Wiring Duct

C2. Surface Raceway

C3. Abrasion Protection

C4. Cable Management

D1. Terminals

D2. Power Connectors

D3. Grounding Connectors

E1. Labeling Systems

E2. Labels

E3. Pre-Printed & Write-On Markers

E4. Permanent Identification

E5. Lockout/Tagout & Safety Solutions

F. Index

Part Number	Length		Width		Max. Bundle Dia.		Min. Loop Tensile Str.		Std. Pkg. Qty.	Std. Ctn. Qty.
	In.	mm	In.	mm	In.	mm	Lbs.	N		
UL Listed Loop Ties (Maroon) – Slot allows for pre-wrapping of bundles										
HLTP2I-X12	8.0	203	.500	12.7	1.91	49	40	178	10	100
HLTP3I-X12	12.0	305	.500	12.7	3.18	81	40	178	10	100
UL Listed Loop Ties (Black) – Slot allows for pre-wrapping of bundles										
HLTP2I-X0	8.0	203	.500	12.7	1.91	49	18	80	10	100
HLTP3I-X0	12.0	305	.500	12.7	3.18	81	18	80	10	100
UL Listed Strip Ties (Maroon) – Perforated in convenient 6", 12", and 18" strips										
HLSP1.5S-X12	6.0	152	.750	19.1	1.50	38	50	222	10	100
HLSP3S-X12	12.0	305	.750	19.1	3.20	81	50	222	10	100
HLSP5S-X12	18.0	457	.750	19.1	5.00	127	50	222	10	100
UL Listed Strip Ties (Black) – Perforated in convenient 6", 12", and 18" strips										
HLSP1.5S-X0	6.0	152	.750	19.1	1.50	38	18	80	10	100
HLSP3S-X0	12.0	305	.750	19.1	3.20	81	18	80	10	100
HLSP5S-X0	18.0	457	.750	19.1	5.00	127	18	80	10	100

TAK-TAPE™ Hook & Loop Cable Tie Rolls

- Strong, low profile, flexible material is safe to use on high performance cabling protecting against over-tensioning
- Adjustable, releasable, and re-usable
- Cost-effective for general purpose bundling
- Continuous rolls can be easily cut to size – PANDUIT cutter included with TTS-35RX0
- Handy, re-usable plastic case with TTS-20R0, keeps material clean

- Leaves no residue
- Available in black color
- Operating temperature range: -22°F to 194°F (-30°C to 90°C)
- Complementary mounts available, see page B2.10

Note: Minimum 2" overlap required to achieve loop tensile rating.



Part Number	Length		Width		Max. Bundle Dia.		Min. Loop Tensile Str.		Std. Pkg. Qty.	Std. Ctn. Qty.
	Ft.	m	In.	mm	In.	mm	Lbs.	N		
TTS-20R0	20.0	6.1	.750	19.1	Various	Various	40	178	1	10
TTS-35R3-0	35.0	10.7	.750	19.1	Various	Various	40	178	1	8
TTS-35RX0	35.0	10.7	.750	19.1	Various	Various	40	178	1	10

Std. Pkg. Qty. of TTS-35R3-0 denotes 1 package of three 35' rolls, TTS-35RX0 denotes 1 package of ten 35' rolls.

ULTRA-CINCH™ Hook & Loop Cable Ties

- Unique material with hooks and loops on same side allows user to secure a greater range of bundle diameters, including smaller bundles
- Soft, premium material is safe to use on high performance cabling, protecting against over-tensioning
- Adjustable, releasable, and re-usable multiple times – ideal for applications requiring frequent moves, adds, or changes
- Low profile contoured cinch ring provides extra strength and bundle tightness while reducing overall bundle size
- Grommet (UGCTC and UGCTE styles) offers strength and assures reliable installations that resist pullout when bundling and mounting cables within cabinet applications
- Tapered tip facilitates easy, snag-free threading to speed installation
- Use flat-head screws for grommet applications shown below

Note: Minimum 2" overlap required to achieve loop tensile rating.

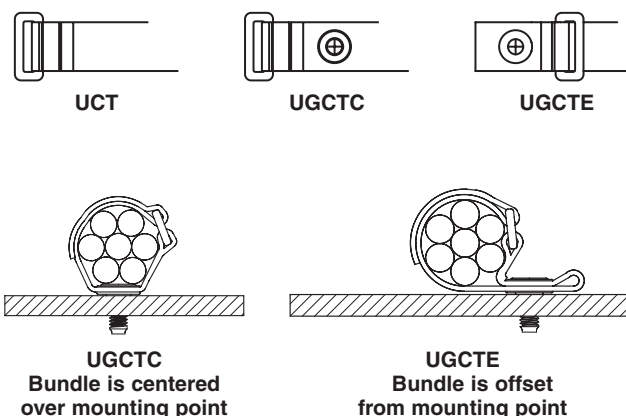

Part Number	Length		Width		Max. Bundle Dia.		Min. Loop Tensile Str.		Std. Pkg. Qty.	Std. Ctn. Qty.
	In.	mm	In.	mm	In.	mm	Lbs.	N		
Cinch Ties										
UCT3S-X0	12.0	305	.850	21.6	3.00	76	50	222	10	100
UCT5S-X0	18.0	457	.850	21.6	5.00	127	50	222	10	100
Cinch Ties – Center Mount Grommet (Bundle is centered over mounting point)										
UGCTC3S-X0	12.0	305	.850	21.6	3.00	76	50	222	10	100
UGCTC5S-X0	18.0	457	.850	21.6	5.00	127	50	222	10	100
Cinch Ties – End Mount Grommet (Bundle is offset from mounting point)										
UGCTE3S-X0	12.0	305	.850	21.6	3.00	76	50	222	10	100
UGCTE5S-X0	18.7	475	.850	21.6	5.00	127	50	222	10	100

Note: 1/4" (6mm) diameter mounting hole on grommet style cinch ties.

Flat Head Screws for Grommet Cinch Ties

Part Number	Part Description	Std. Pkg. Qty.	Std. Ctn. Qty.
UCTGS1224-X	12-24 UNC x 5/8mm (.625") flat head phillips screw	10	100
UCTGSM5-X	M5 x 16mm flat head phillips screw	10	100
UCTGSM6-X	M6 x 16mm flat head phillips screw	10	100

A. System Overview

B1. Cable Ties

B2. Cable Accessories

B3. Stainless Steel Ties

C1. Wiring Duct

C2. Surface Raceway

C3. Abrasion Protection

C4. Cable Management

D1. Terminals

D2. Power Connectors

D3. Grounding Connectors

E1. Labeling Systems

E2. Labels

E3. Pre-Printed & Write-On Markers

E4. Permanent Identification

E5. Lockout/Tagout & Safety Solutions

F. Index

A.
System
Overview

Hook and Loop Cable Ties

B1.
Cable Ties

Color Chart

Color	PANDUIT Suffix
Black	0
Red	2
Orange	3
Yellow	4
Green	5

Color	PANDUIT Suffix
Blue	6
Gray	8
White	10
Maroon	12

C1.
Wiring
Duct

C2.
Surface
Raceway

Part Number Availability List

C3.
Abrasion
Protection

Standard Packaging	
Part Number	Color
HLM-15R	0,2,3,4,5,6,8,10
HLS-15R	0,2,3,4,5,6,8,10
HLS-75R	0,2,3,4,5,6,8,10
HLS1.5S-X	0,2,3,4,5,6,8,10
HLS3S-X	0,2,3,4,5,6,8,10
HLS5S-X	0,2,3,4,5,6,8,10
HLSP1.5S-X	0,12
HLSP3S-X	0,12
HLSP5S-X	0,12
HLT2I-X	0,2,3,4,5,6,8,10
HLT3I-X	0,2,3,4,5,6,8,10
HLTP2I-X	0,12
HLTP3I-X	0,12
TTS-20R	0
TTS-35RX	0
TTS-35R3	0
UCT3S-X	0,2,3,4,5,6,8,10
UCT5S-X	0,2,3,4,5,6,8,10
UGCTC3S-X	0,2,3,4,5,6,8,10
UGCTC5S-X	0,2,3,4,5,6,8,10
UGCTE3S-X	0,2,3,4,5,6,8,10
UGCTE5S-X	0,2,3,4,5,6,8,10

C4.
Cable
Management

D1.
Terminals

D2.
Power
Connectors

D3.
Grounding
Connectors

E1.
Labeling
Systems

E2.
Labels

E3.
Pre-Printed
& Write-On
Markers

E4.
Permanent
Identification

E5.
Lockout/
Tagout/
& Safety
Solutions

F.
Index

Hot Stamping Service Custom Printed Cable Ties

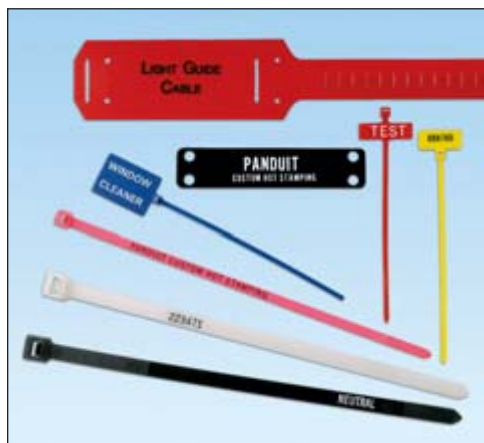

Custom Hot Stamping Service provides a permanent, high quality imprinted message on *PANDUIT* cable ties and marker plates. Graphics, text, numbers and colors provide a variety of choices for customization.

Hot stamped cable ties and marker plates are typically used for identification, or for labeling critical components. *PANDUIT* cable ties, marker ties, marker plates and marker straps are available to suit your application.

Your choice of:

- Seven text colors (black, blue, green, red, yellow, orange, white)
- A variety of characters and fonts
- Sequential numbering
- Special customer logos and diagrams

FAST! TWO WEEK LEAD TIME

Minimum Order: (Pieces/part number and message)

- 5,000 for Miniature, Intermediate, Standard and Heavy-Standard cross section cable ties
- 3,000 for Light-Heavy, Heavy, and Extra-Heavy cross section cable ties

For hot stamping orders and inquiries, please call 1-800-777-3300



Cable Ties

- Used wherever you need to bundle wire, cable, hose or tubing
- A variety of colors for color-coding applications
- Cross Sections: Intermediate, Standard, Heavy-Standard, Light-Heavy, Heavy and Extra-Heavy

Marker and Flag Ties

- Fasten and identify bundles at the same time
- A variety of colors for color-coding applications
- Cross Sections: Miniature and Standard

Marker Plates

- Mount in any direction, either vertically or horizontally as flags, tags, or wrap-around identification plates.
- White or Weather Resistant black color
- Marker plate sizes:

1.50" x .75"	2.50" x .75"
1.75" x .75"	3.50" x .75"
2.00" x .75"	2.50" x 1.75"

Cable Marker Straps

- Identify and code telephone and fiber optic cable – replaces costly and cumbersome lead marking tags
- Lightweight and easy to install
- Can be used as **wrap-around** or **flag** marker
- Also can be used in underground identification applications
- Polyethylene material available in red and gray
- Marking area: 1.50" x 2.62"

A.
System
Overview

B1.
Cable Ties

B2.
Cable
Accessories

B3.
Stainless
Steel Ties

C1.
Wiring
Duct

C2.
Surface
Raceway

C3.
Abrasion
Protection

C4.
Cable
Management

D1.
Terminals

D2.
Power
Connectors

D3.
Grounding
Connectors

E1.
Labeling
Systems

E2.
Labels

E3.
Pre-Printed
& Write-On
Markers

E4.
Permanent
Identification

E5.
Lockout/
Tagout
& Safety
Solutions

F.
Index



PANDUIT Cable Tie Approvals

	Logo (Symbol)	Agency	Spec/Approval	Requirement	Applicable Products
A. System Overview					
B1. Cable Ties					
B2. Cable Accessories		Underwriters Laboratories, Inc.	File E56854 and MH29590	ZODZ(7), ZODZ(8), ALKW	Most miniature, intermediate, standard, light-heavy and heavy cross section ties are Recognized or Listed in the US and Canada
B3. Stainless Steel Ties		Canadian Standards Association	File 031212	C22.2 No. 18.5-02 under the category "Fittings – Positioning Devices"	Most miniature, intermediate, standard, light-heavy and heavy cross section ties are Recognized or Listed in the US and Canada
C1. Wiring Duct		Conformity European	Low Voltage Directive 73/23/EEC (amended 93/68/EEC). <i>PAN-TY</i> ® and <i>DOME-TOP</i> ® Barb Ty Cable Ties also meet the requirements from EN50146	CE Marking is required for products sold within the European Union. CE Marking Directives specify the minimum performance of these products. Applying the CE mark signifies compliance with essential requirements of specific directives.	All cable tie products
C2. Surface Raceway					
C3. Abrasion Protection		ABS (American Bureau of Shipping)	05-HS463235-PDA	2005 Vessel Rules 1-1-4/7.7, 4-8/421.9.3 2001 MODU Rules 4-3-3/5.9.1	PLT Series, BT Series
C4. Cable Management		Bureau Veritas	Cert 05968/C0 BV 1178B/BVN/04 File ACE 14/601/01	Bureau Veritas Rules for the Classification of Steel Ships	PLT Series, BT Series, PRT Series, CBR Series
D1. Terminals		Det Norske Veritas	E-6405	Det Norske Veritas' Rules for Classification of Ships and Mobile Offshore Units	PLT Series, PLC Series, PLM Series, PRT Series, PLWP Series, PRWP Series, PRST Series
D2. Power Connectors		Germanischer Lloyd	30562-83HH, 32666-83HH, 51796-89HH, 98731-96HH	Germanischer Lloyd Approval	PLT Series, BT Series
D3. Grounding Connectors		Germany (VG) Military	K17/96066	VG 95 387 – 100 MS 3367F	PLT Series, BT Series, SST Series
E1. Labeling Systems		Korean Register of Shipping	NYK06431-EL001, EL002, EL003	Type Approval for the Rules for Classification of Steel Ships	PLT Series, BT Series, Mounts
E2. Labels		Lloyd's Register of Shipping	89/60111 (E1)	Lloyd's Register Type Approval	PLT Series, BT Series, SST Series
E3. Pre-Printed & Write-On Markers		NRC (Nuclear Regulatory Commission)	NRC 10CFR50	Quality Assurance Criteria for Nuclear Plants and Reprocessing Plants	All cable tie products
E4. Permanent Identification		Nippon Kaiji Kyokai	85VZ004B, 85BZ005B, 85VZ006B	Nippon Kaiji Kyokai Type Approval	PLT2H-12H, PLT2EH-12EH, PRT2EH-12EH, SST2H-8H
E5. Lockout/Tagout & Safety Solutions		Plenum-Rated	<i>PANDUIT</i> logo	<i>PANDUIT</i> symbol indicates that the cable ties represented are suitable for use in plenum or air handling spaces in accordance with Sec. 300.22 (C) and (D) of the National Electrical Code and Rules 12-010 (3), (4), and (5) and 12-020 of the Canadian Electrical Code, Part I.	HALAR [▲] (702Y), Hook and Loop Cable Ties (HLSP/HLTP), and select Nylon 6.6 cable ties as noted throughout catalog ▲HALAR is a registered trademark of Solvay Solexis, Inc.
F. Index		US Military Aerospace Standard	QPL-AS23190-2	SAE spec AS23190	See Military Cross Reference Page B1.93
		AQA International	ISO/TS16949	AQA registration. Quality management system assessment certificate	Tinley Park, Illinois Manufacturing Operations (Cable Tie Division) Quality Management System

Military Cross Reference

The PANDUIT cable ties and marker ties listed in the following tables meet all of the testing requirements of Aerospace Standard SAE-AS23190A (formerly MIL-S-23190E) and the dimensional requirements of Aerospace Standards SAE-AS33671 (formerly MS3367) and SAE-AS33681 (formerly MS3368).

Cable Tie Cross Reference						
Mil. Std. Part Number	Color	PAN-TY®	DOME-TOP® Barb Ty	STA-STRAP®	BELT-TY™ In-Line	CONTOUR-TY®
MS3367-1-0	Black*	PLT2S-C00, -M00	—	—	—	—
MS3367-1-1	Brown	PLT2S-C1, -M1	BT2S-M1	—	—	—
MS3367-1-2	Red	PLT2S-C2, -M2	BT2S-M2	—	—	—
MS3367-1-3	Orange	PLT2S-C3, -M3	BT2S-M3	—	—	—
MS3367-1-4	Yellow	PLT2S-C4Y, -M4Y	BT2S-M4Y	—	—	—
MS3367-1-5	Green	PLT2S-C5, -M5	BT2S-M5	—	—	—
MS3367-1-6	Blue	PLT2S-C6, -M6	BT2S-M6	—	—	—
MS3367-1-7	Purple	PLT2S-C7, -M7	BT2S-M7	—	—	—
MS3367-1-8	Gray	PLT2S-C8, -M8	BT2S-M8	—	—	—
MS3367-1-9	Natural	PLT2S-C, -M, -VMR	BT2S-C, -M	SST2S-C, -M	—	—
MS3367-2-0	Black*	PLT4S-C00, -M00	—	—	—	—
MS3367-2-1	Brown	PLT4S-M1	—	—	—	—
MS3367-2-2	Red	PLT4S-C2, -M2	BT4S-M2	SST4S-M2	—	—
MS3367-2-3	Orange	PLT4S-C3, -M3	BT4S-M3	—	—	—
MS3367-2-4	Yellow	PLT4S-C4Y, -M4Y	BT4S-M4Y	—	—	—
MS3367-2-5	Green	PLT4S-C5, -M5	BT4S-M5	—	—	—
MS3367-2-6	Blue	PLT4S-C6, -M6	BT4S-M6	—	—	—
MS3367-2-7	Purple	PLT4S-C7, -M7	BT4S-M7	—	—	—
MS3367-2-8	Gray	PLT4S-C8, -M8	BT4S-M8	—	—	—
MS3367-2-9	Natural	PLT4S-C, -M	BT4S-C, -M	SST4S-C, -M	—	—
MS3367-3-0	Black*	PLT4H-L00, -TL00	—	—	—	—
MS3367-3-1	Brown	PLT4H-TL1	—	—	—	—
MS3367-3-2	Red	PLT4H-TL2	—	—	—	—
MS3367-3-3	Orange	PLT4H-TL3	—	—	—	—
MS3367-3-4	Yellow	PLT4H-TL4Y	—	—	—	—
MS3367-3-5	Green	PLT4H-TL5	—	—	—	—
MS3367-3-6	Blue	PLT4H-TL6	—	—	—	—
MS3367-3-9	Natural	PLT4H-L, -C, -TL	BT4LH-L, -TL	SST4H-L, -D	—	—
MS3367-4-0	Black*	PLT1M-C00, -M00, -XMR00	—	—	—	—
MS3367-4-0	Black*	PLT1.5M-XMR00	—	—	—	—
MS3367-4-1	Brown	PLT1M-C1, -M1, -XMR1	BT1M-M1	—	—	—
MS3367-4-2	Red	PLT1M-C2, -M2, -XMR2	BT1M-M2	—	—	—
MS3367-4-3	Orange	PLT1M-C3, -M3, -XMR3	BT1M-M3	—	—	—
MS3367-4-4	Yellow	PLT1M-C4Y, -M4Y, -XMR4Y	BT1M-M4Y	—	—	—
MS3367-4-5	Green	PLT1M-C5, -M5, -XMR5	BT1M-M5	—	—	—
MS3367-4-6	Blue	PLT1M-C6, -M6, -XMR6	BT1M-M6	—	—	—
MS3367-4-7	Purple	PLT1M-C7, -M7, -XMR7	BT1M-M7	—	—	—
MS3367-4-8	Gray	PLT1M-C8, -M8, -XMR8	BT1M-M8	—	—	—
MS3367-4-9	Natural	PLT1M-C, -M, -XMR	BT1M-C, -M, -XMR	SST1M-C, -M	—	—
MS3367-4-9	Natural	PLT.7M-C, -M	—	—	—	—
MS3367-4-9	Natural	PLT1.5M-XMR	BT1.5M-XMR	—	—	—
MS3367-5-0	Black*	PLT1.5I-M00	—	—	—	—
MS3367-5-1	Brown	PLT1.5I-C1, -M1	BT1.5I-M1	—	—	—
MS3367-5-2	Red	PLT1.5I-C2, -M2	BT1.5I-M2	—	—	—
MS3367-5-3	Orange	PLT1.5I-C3, -M3	BT1.5I-M3	—	—	—
MS3367-5-4	Yellow	PLT1.5I-C4Y, -M4Y	BT1.5I-M4Y	—	—	—

*Weather resistant per ASTM D 4066-94B.

Table continues on page B1.94

A.
System
Overview

Military Cross Reference (continued)

B1.
Cable Ties

B2.
Cable
Accessories

B3.
Stainless
Steel Ties

C1.
Wiring
Duct

C2.
Surface
Raceway

C3.
Abrasion
Protection

C4.
Cable
Management

D1.
Terminals

D2.
Power
Connectors

D3.
Grounding
Connectors

E1.
Labeling
Systems

E2.
Labels

E3.
Pre-Printed
& Write-On
Markers

E4.
Permanent
Identification

E5.
Lockout/
Tagout/
& Safety
Solutions

F.
Index

Cable Tie Cross Reference

Mil. Std. Part Number	Color	PAN-TY®	DOME-TOP® Barb Ty	STA-STRAP®	BELT-TY™ In-Line	CONTOUR-TY®
MS3367-5-5	Green	PLT1.5I-C5, -M5	BT1.5I-M5	—	—	—
MS3367-5-6	Blue	PLT1.5I-C6, -M6	BT1.5I-M6	—	—	—
MS3367-5-7	Purple	PLT1.5I-C7, -M7	BT1.5I-M7	—	—	—
MS3367-5-8	Gray	PLT1.5I-C8, -M8	BT1.5I-M8	—	—	—
MS3367-5-9	Natural	PLT1.5I-C, -M	BT1.5I-C, -M	SST1.5I-C, -M	—	—
MS3367-6-9	Natural	PLT8LH-L, -C	BT8LH-L, -C	SST8H-L, -D	—	—
MS3367-6-9	Natural	—	BT9LH-L, -C	—	—	—
MS3367-7-0	Black*	PLT3S-C00, -M00	—	—	—	—
MS3367-7-1	Brown	PLT3S-M1	—	—	—	—
MS3367-7-2	Red	PLT3S-C2, -M2	BT3S-C2	—	—	—
MS3367-7-3	Orange	PLT3S-M3	—	—	—	—
MS3367-7-4	Yellow	PLT3S-M4Y	—	—	—	—
MS3367-7-5	Green	PLT3S-M5	—	—	—	—
MS3367-7-6	Blue	PLT3S-M6	—	—	—	—
MS3367-7-7	Purple	PLT3S-M7	—	—	—	—
MS3367-7-8	Gray	PLT3S-M8	—	—	—	—
MS3367-7-9	Natural	PLT3S-C, -M	BT3S-C, -M	SST3S-C, -M	—	—
MS3367-8-9	Natural	PLT5H-L, -C	—	—	—	—
MS3367-9-9	Natural	PLT6H-L, -C	—	—	—	—
MS3367-11-9	Natural	PLT8H-L, -C	—	—	—	—
MS3367-14-9	Natural	PLT13H-Q, -C	—	—	—	—
MS3367-20-9	Natural	PLT5EH-Q, -C	—	—	—	—
MS3367-21-9	Natural	PLT6EH-Q, -C	—	—	—	—
MS3367-22-9	Natural	PLT8EH-C	—	—	—	—
MS3367-23-9	Natural	—	—	—	ILT2S-C, -M	—
MS3367-24-9	Natural	—	—	—	ILT4S-C, -M	—
MS3367-25-9	Natural	—	—	—	ILT4LH-TL	—
MS3367-29-9	Natural	—	—	—	ILT3S-C, -M	—
MS3367-30-9	Natural	—	—	—	—	CBR1M-M
MS3367-31-9	Natural	—	—	—	—	CBR1.5M-M
MS3367-32-1	Brown	—	—	—	—	CBR2M-M1
MS3367-32-2	Red	—	—	—	—	CBR2M-M2
MS3367-32-3	Orange	—	—	—	—	CBR2M-M3
MS3367-32-4	Yellow	—	—	—	—	CBR2M-M4Y
MS3367-32-5	Green	—	—	—	—	CBR2M-M5
MS3367-32-6	Blue	—	—	—	—	CBR2M-M6
MS3367-32-7	Purple	—	—	—	—	CBR2M-M7
MS3367-32-9	Natural	—	—	—	—	CBR2M-M
MS3367-33-9	Natural	—	—	—	—	CBR1.5I-M
MS3367-34-1	Brown	—	—	—	—	CBR3I-M1
MS3367-34-2	Red	—	—	—	—	CBR3I-M2
MS3367-34-3	Orange	—	—	—	—	CBR3I-M3
MS3367-34-4	Yellow	—	—	—	—	CBR3I-M4Y
MS3367-34-5	Green	—	—	—	—	CBR3I-M5
MS3367-34-6	Blue	—	—	—	—	CBR3I-M6
MS3367-34-7	Purple	—	—	—	—	CBR3I-M7
MS3367-34-8	Gray	—	—	—	—	CBR3I-M8
MS3367-34-9	Natural	—	—	—	—	CBR3I-M
MS3367-35-9	Natural	—	—	—	—	CBR4I-M

*Weather resistant per ASTM D 4066-94B.

Cable Tie Cross Reference

Mil. Std. Part Number	Color	PAN-TY®	DOME-TOP® Barb Ty	STA-STRAP®	BELT-TY™ In-Line	CONTOUR-TY®
MS3367-36-9	Natural	—	—	—	—	CBR2S-M
MS3367-37-9	Natural	—	—	—	—	CBR3S-M
MS3367-38-9	Natural	—	—	—	—	CBR4S-M
MS3367-39-9	Natural	—	—	—	—	CBR2HS-D
MS3367-40-9	Natural	—	—	—	—	CBR4LH-TL
MS3367-41-9	Natural	—	—	—	—	CBR6LH-C
MS3368-1-2A	Red	PLM2S-D2	—	—	—	—
MS3368-1-3A	Orange	PLM2S-D3	—	—	—	—
MS3368-1-4A	Yellow	PLM2S-C4Y, -D4Y	—	—	—	—
MS3368-1-5A	Green	PLM2S-D5	—	—	—	—
MS3368-1-6A	Blue	PLM2S-D6	—	—	—	—
MS3368-1-8A	Gray	PLM2S-D8	—	—	—	—
MS3368-1-9A	Natural	PLM2S-C, -D	BM2S-C, -D	—	—	—
MS3368-1-9B	Natural	—	—	SSM2S-C, -D	—	—
MS3368-2-2A	Red	PLM4S-D2	—	—	—	—
MS3368-2-4A	Yellow	PLM4S-D4Y	—	—	—	—
MS3368-2-6A	Blue	PLM4S-D6	—	—	—	—
MS3368-2-9A	Natural	PLM4S-C, -D	BM4S-C, -D	—	—	—
MS3368-2-9B	Natural	—	—	SSM4S-D	—	—
MS3368-3-4C	Yellow	PL2M2S-D4Y	—	—	—	—
MS3368-3-9C	Natural	PL2M2S-L, -D	B2M2S-D	—	—	—
MS3368-4-4D	Yellow	PL3M2S-D4Y	—	—	—	—
MS3368-4-9D	Natural	PL3M2S-L, -D	B3M2S-TL	—	—	—
MS3368-5-1E	Brown	PLM1M-M1	—	—	—	—
MS3368-5-2E	Red	PLM1M-M2	—	—	—	—
MS3368-5-3E	Orange	PLM1M-M3	—	—	—	—
MS3368-5-4E	Yellow	PLM1M-M4Y	—	—	—	—
MS3368-5-5E	Green	PLM1M-M5	—	—	—	—
MS3368-5-6E	Blue	PLM1M-M6	—	—	—	—
MS3368-5-7E	Purple	PLM1M-M7	—	—	—	—
MS3368-5-8E	Gray	PLM1M-M8	—	—	—	—
MS3368-5-9E	Natural	PLM1M-C, -M	BM1M-C, -M	—	—	—

Installation Tools

The *PANDUIT* installation tools listed in the table below meet all of the testing requirements of MIL-T-81306 and the dimensional requirements of MS90387.

Mil. Std. Part Number	PANDUIT P/N
MS90387-1	GTS, GS2B
MS90387-2	GS4H

A.
System
Overview

Cable Tie Selection and Specification Guidelines

B1.
Cable Ties

Selecting the Proper Cable Tie Material for Your Application

B2.
Cable
Accessories

By using the information on our material selection chart on pages B1.2 and B1.3 as a guide, the user will be better equipped to select the best cable tie and material suited to perform its intended function over a long period of time.

B3.
Stainless
Steel Ties

For long life and dependable service, there are many factors to consider when selecting the proper cable tie for each application. Since it is impossible for *PANDUIT* to provide data on all the various combinations of conditions which may arise, it is suggested that this data be used as a guide. Sample cable ties should be tested under actual end-use conditions to determine the correct cable tie for the application.

C1.
Wiring
Duct

To select the optimum cable tie for a specific application, the chart on pages B1.2 and B1.3 can be used as a reference. First, determine the most critical design criteria and then read across the table to find which material is most suitable to meet this need. Next, review the other criteria by scanning in a vertical direction on the chart and then make your final selection.

C2.
Surface
Raceway

Example No. 1

Application	Selection
The application requires high radiation (2 x 10 ⁹ rads) resistance and excellent resistance to hydrocarbons.	The best choice is PEEK, TEFZEL [■] , or HALAR [▲] . The price is higher than other materials, but all have high ratings in resistance to radiation and hydrocarbons.

C4.
Cable
Management

Example No. 2

Application	Selection
The application requires a low cost material, good ultraviolet resistance, and good resistance to acid rains.	The best choice is Weather Resistant Polypropylene. Price is medium, the UV rating is 6, and the acid resistance rating is 9.

D1.
Terminals

■TEFZEL is a registered trademark of E.I. du Pont de Nemours and Company.
▲HALAR is a registered trademark of Solvay Solexis, Inc.

D2.
Power
Connectors

D3.
Grounding
Connectors

E1.
Labeling
Systems

E2.
Labels

E3.
Pre-Printed
& Write-On
Markers

E4.
Permanent
Identification

E5.
Lockout/
Tagout/
& Safety
Solutions

F.
Index

Weathering

Over a period of time, ultraviolet light (a component of sunlight) attacks most plastic materials and reduces their properties by breaking the molecular chain. The material breakdown is accompanied by reductions in tensile strength and elongation, increased brittleness, color changes and loss of surface gloss.

Carbon black, which is used in *PANDUIT* nylon, polypropylene, and acetal cable ties, is one of the most effective stabilizers known today. A uniform dispersion of carbon black provides good ultraviolet light resistance without adversely affecting physical properties. The addition of carbon black, or any other ultraviolet light stabilizer, prolongs the useful outdoor life of plastic products, but it does not totally eliminate the destructive effects of the light. Some plastics, such as TEFZEL[■] or HALAR[▲], are intrinsically very resistant to ultraviolet light and do not require stabilizing additives.

Weathering Test Methods

In order to monitor the effects of ultraviolet light and the effectiveness of ultraviolet stabilizers, *PANDUIT*, in conformance with industry standards, adopted two methods of weatherability testing: Outdoor Aging and Accelerated Weather Aging.

Outdoor Aging

The Outdoor Aging method is probably the best and most realistic method of the two. It is conducted in accordance with ASTM D 1435 Standard Practice for Outdoor Weathering of Plastics, and allows the material to be affected by not only ultraviolet light, but by all other outdoor elements as well. Although this may more closely approximate an actual application, two drawbacks do exist. The period of time required to produce property decay and material failure may be quite long, and varying adverse chemical environments cannot be tested.

Accelerated Weather Aging

Accelerated weathering tests are conducted to estimate the rate of degradation due to a combination of ultraviolet light, temperature, and moisture. The methods used are in accordance with the following standards:

- ASTM D 1499, Operating Light and Water Exposure Apparatus (Carbon-Arc type) for exposure to plastics
- ASTM G 154-04, Operating Light and Water Exposure (Fluorescent UV Condensation type) for exposure of non-metallic materials

The condition specified in ASTM D 1499 utilizes a water spray and a carbon arc to simulate natural sunshine. The test chamber is operated 20 hrs/day with a two-hour cycle of 108 minutes of simulated sunshine and twelve minutes of sunshine and water spray. The temperature of a black body inside the chamber is approximately 63°C (145°F) during the “sunshine only” portion of the cycle. Humidity is not controlled inside the chamber.

The test chamber per ASTM G 154-04 uses fluorescent sun lamps to generate ultraviolet light only. A heated water pan produces condensation during a portion of the cycle. The daily cycle is composed of 20 hours of light followed by 4 hours of condensation. Black body temperatures during the light cycle are 50°C (122°F) and 40°C (104°F) during the condensation cycle.

PANDUIT has also designed a special chamber, which is used to simulate the effect of acid rain and ultraviolet light on cable tie materials. The effects of other common chemicals, such as road salt, are also evaluated in this chamber.

These methods are effective in quickly determining the ultraviolet light resistance of the various cable tie materials, but it must be emphasized that there are no exact correlations between accelerated aging and actual outdoor exposure.

[■]TEFZEL is a registered trademark of E.I. du Pont de Nemours and Company.

[▲]HALAR is a registered trademark of Solvay Solexis, Inc.

A.
System
Overview

B1.
Cable Ties

B2.
Cable
Accessories

B3.
Stainless
Steel Ties

C1.
Wiring
Duct

C2.
Surface
Raceway

C3.
Abrasion
Protection

C4.
Cable
Management

D1.
Terminals

D2.
Power
Connectors

D3.
Grounding
Connectors

E1.
Labeling
Systems

E2.
Labels

E3.
Pre-Printed
& Write-On
Markers

E4.
Permanent
Identification

E5.
Lockout/
Tagout
& Safety
Solutions

F.
Index

A.
System
Overview

Weathering (continued)

B1.
Cable Ties

Material Failure Testing

Property decay can lead to three different modes of failure: loss of strength, loss of toughness, or change in appearance. The critical mode for any given application would depend upon the application and the requirements it places upon the material itself.

B2.
Cable
Accessories

Loss of strength is monitored by tensile testing samples of the material before and after it has been weathered. This test will reveal the decreasing strength accompanied by extended weathering.

B3.
Stainless
Steel Ties

Loss of toughness can be monitored by measuring changes in elongation and impact strength. As ultraviolet light exposure time increases and the material becomes brittle, its elongation and impact strength are greatly reduced. It is important to note that brittle failures can occur even when the tensile strength shows no change.

C1.
Wiring
Duct

Although change in appearance is normally not a failure mode for cable ties, the plastic does tend to discolor and lose its surface gloss as exposure increases. These changes can be measured by color difference using Adams units, which are similar to National Bureau of Standard units.

C2.
Surface
Raceway

PANDUIT has its own weathering test program to determine estimated life of various cable tie materials. This includes examining many previously aged samples obtained throughout the world.

C3.
Abrasion
Protection

In all cases, the amount of property decay increased with increasing exposure to ultraviolet light. The principal signs of degradation were found to be brittleness, cracking, and loss of surface gloss. It was also determined that the time for failure to occur was shorter than indicated from industry tests performed on material samples. This discrepancy is in part due to the fact that cable ties were tested in an end use, stressed condition, while most plastic resin suppliers conduct weathering tests using unstressed test bars.

C4.
Cable
Management

Five cable tie materials have superior ultraviolet light resistance: TEFZEL[■], HALAR[▲], Weather Resistant Acetal, Nylon 12 and Stainless Steel.

D1.
Terminals

Determining the outdoor life expectancy of any material is difficult since there are other factors, besides ultraviolet light stability, which have to be considered. These factors are listed below and should be considered before specifying a cable tie material.

D2.
Power
Connectors

Table A – External Factors That Affect the Life of a Cable Tie

Factor	Effect on Cable Tie Life
Chemicals	Applications which have chemicals present can reduce the life of a tie. This is the most detrimental factor to the life of a tie.
Bundle diameter	As the bundle diameter is reduced, the tie has more bending stress. A thick strap on a small bundle diameter has more stress.
Loading	If the tie is under high loading, this will add additional stress on the tie body.
Thickness	A thinner tie will have a decreased life since surface cracks will penetrate the thickness of the tie faster.
Vibration	Applications with high vibrations will cause impact, which will propagate any surface cracks.
Degree of exposure	No shield or shade, southern exposure, higher altitudes and high temperatures, decrease the life of a cable tie.
Moisture	High humidity plus high temperature can result in degradation due to hydrolysis in nylon.
Galvanized metals	Acid rain and acid moisture acting on galvanized metals release chemicals known to attack Nylon 6.6.

Weathering Life Expectancy	
Material, Color (Part Number Suffix)	Years*
Polypropylene, Green (109)	1
Nylon 6.6, Natural (No suffix)	1 – 2
Flame Retardant Nylon 6.6, Black (60)	1 – 2
Flame Retardant Nylon 6.6, Ivory (69)	1 – 2
Heat Stabilized Nylon 6.6, Natural (39)	1 – 2
PEEK, Polyetheretherketone, Translucent Brown (71)	1 – 2
Heat Stabilized Nylon 6.6, Black (30)	4 – 5
Weather Resistant Polypropylene, Black (100)	7 – 9
Weather Resistant Nylon 6.6, Black (0 and 00)	7 – 9
Heat Stabilized Weather Resistant Nylon 6.6, Black (300)	7 – 9
Weather Resistant Nylon 12, Black (120)	12 – 15
TEFZEL [■] , Aqua Blue (76)	>15
HALAR [▲] , Maroon (702Y)	>15
Weather Resistant Acetal, Black	>20
Stainless Steel	>30

*Based on the assumption of minimum loading, no chemical attack and impact-free conditions.

■TEFZEL is a registered trademark of E.I. du Pont de Nemours and Company.

▲HALAR is a registered trademark of Solvay Solexis, Inc.

E5.
Lockout/
Tagout
& Safety
Solutions

F.
Index

Flammability

Flammability

A number of test procedures have been developed which can be used for the evaluation and comparison of various materials to support combustion.

UL 94 Vertical Burning Test

Samples of a material, with dimensions 127mm by 12.7mm and the thickness of the intended end use product, are tested in an unaged “as manufactured” state and in an aged state (seven days at 158°F, 70°C). The test requires the placement of a precisely controlled flame under a vertically supported specimen for a ten second period. The controlled flame is removed and the duration of flaming combustion of the specimen is recorded. When the flaming combustion of the specimen extinguishes, it is immediately subjected to an additional controlled flame exposure. After the additional ten seconds of exposure, the controlled flame is removed, and the duration of flaming combustion of the specimen is recorded. A piece of surgical cotton is placed under the specimen. If drips ignite the cotton, this fact is also recorded.

Materials Classed 94V-0

Requirements:

- None of the specimens will burn with flaming combustion for more than ten seconds after either application of the controlled flame
- The total flaming combustion time will not exceed 50 seconds for the ten controlled flame applications (two controlled flame applications for each of the five specimens)
- None of the specimens will burn with flaming or glowing combustion up to the holding clamp
- None of the specimens will drip flaming particles that ignite the dry absorbent surgical cotton located 12 inches (305mm) below the test specimen
- None of the specimens will exhibit glowing combustion that persists for more than 30 seconds after the second removal of the controlled flame

Materials Classed 94V-1

Requirements:

- None of the specimens will burn with flaming combustion for more than 30 seconds after either application of the controlled flame
- The total flaming combustion time will not exceed 250 seconds for the ten controlled flame applications (two controlled flame applications for each of the five specimens)
- None of the specimens will burn with flaming or glowing combustion up to the holding clamp
- Specimens may drip flaming particles which burn only briefly, and may not ignite the dry absorbent surgical cotton located 12 inches (305mm) below the test specimen
- None of the specimens will exhibit glowing combustion that persists for more than 60 seconds after the second removal of the controlled flame

Materials Classed 94V-2

Requirements:

- None of the specimens will burn with flaming combustion for more than 30 seconds after either application of the controlled flame
- The total flaming combustion time will not exceed 250 seconds for the ten controlled flame applications (two controlled flame applications for each of the five specimens)
- None of the specimens will burn with flaming or glowing combustion up to the holding clamp
- Specimens may drip flaming particles which burn only briefly, and may ignite the dry absorbent surgical cotton placed 12 inches (305mm) below the test specimen
- None of the specimens will exhibit glowing combustion that persists for more than 60 seconds after the second removal of the controlled flame

A.
System
Overview

B1.
Cable Ties

B2.
Cable
Accessories

B3.
Stainless
Steel Ties

C1.
Wiring
Duct

C2.
Surface
Raceway

C3.
Abrasion
Protection

C4.
Cable
Management

D1.
Terminals

D2.
Power
Connectors

D3.
Grounding
Connectors

E1.
Labeling
Systems

E2.
Labels

E3.
Pre-Printed
& Write-On
Markers

E4.
Permanent
Identification

E5.
Lockout/
Tagout
& Safety
Solutions

F.
Index

Flammability (continued)

ASTM D 635

Samples of a material, with dimensions 125mm by 12.5mm and the thickness of the intended end use product, are tested in an unaged “as manufactured” state. A precisely controlled flame is applied to the specimen and a stopwatch is started. The flame is applied for 30 seconds. The stopwatch is stopped when burning or glowing combustion ceases or when the flame has proceeded to a mark 100mm from the free end. Ten specimens are tested. If any of the specimens burn to the 100mm mark, an additional ten specimens are tested.

Burning Rate

- If two or more specimens have burned to the 100mm mark then Average Burning Rate (cm/min.) shall be reported as the average of the burning rates of all specimens which have burned to the 100mm mark

Average Time of Burning and Average Extent of Burning

- Average time of burning and average extent of burning of the sample shall be reported if none of the ten samples or no more than one of the twenty specimens have burned to the 100mm mark

- Average Time of Burning (ATB):

$$ATB, s = \frac{\sum_0^N [time(sec) - 30(sec)]}{N}$$

N = Number of specimens tested
Rounded to the nearest 5 seconds

- Average Extent of Burning (AEB):

$$AEB, mm = \frac{\sum_0^N [10(mm) - unburned length(mm)]}{N}$$

N = Number of specimens tested
Rounded to the nearest 5mm

Table B – Flammability Ratings

Materials	P/N Suffix	UL 94	ASTM D 635
Nylon 6.6, Natural	None	94V-2 @ .71mm	AEB = 20mm ATB = 5 seconds
Weather Resistant Nylon 6.6, Black (Meets Mil. Spec.)	00	94V-2 @ .71mm	AEB = 20mm ATB = 5 seconds
Weather Resistant Nylon 6.6, Black*	0	94V-2** @ .71mm	AEB = 20mm ATB = 5 seconds
Heat Stabilized Nylon 6.6, Black	30	94V-2 @ .71mm	AEB = 20mm ATB = 5 seconds
Heat Stabilized Nylon 6.6, Natural	39	94V-2 @ .71mm	AEB = 20mm ATB = 5 seconds
Heat Stabilized Weather Resistant Nylon 6.6, Black	300	94V-2 @ .71mm	AEB = 20mm ATB = 5 seconds
Flame Retardant Nylon 6.6, Black	60	94V-0 @ .81mm	AEB = 15mm ATB = < 5 seconds
Flame Retardant Nylon 6.6, Natural (Ivory)	69	94V-0 @ .81mm	AEB = 15mm ATB = < 5 seconds
PEEK, Polyetheretherketone, Translucent Brown	71	94V-0 @ 1.5mm	—
Metal Detectable Nylon 6.6, Blue	86	94 HB @ .71mm	AEB = 20mm ATB = 5 seconds
Weather Resistant Nylon 12, Black	120	94 HB @ 1.6mm	Avg. Burning Rate 1.6cm/min.
Polypropylene, Green	109	94 HB @ .94mm	Avg. Burning Rate 2cm/min.
Weather Resistant Polypropylene, Black	100	94 HB @ .94mm	Avg. Burning Rate 2cm/min.
TEFZEL■, Aqua Blue	76	94V-0 @ 1.5mm	AEB = 15mm ATB = < 5 seconds
HALAR▲, Maroon	702Y	94V-0 @ .18mm	AEB = 15mm ATB = < 5 seconds
Weather Resistant Acetal, Black	DT Prefix	94 HB @ 1.5mm	Avg. Burning Rate 2.8cm/min

*UL Recognized cable ties meet stated ratings. **UL Recognized -0 parts

■TEFZEL is a registered trademark of E.I. du Pont de Nemours and Company.

▲HALAR is a registered trademark of Solvay Solexis, Inc.

Radiation/Moisture/Temperature/Tensile Strength

Radiation

Installed cable ties of various materials have been exposed to different amounts of radiation to determine the maximum acceptable limit. These tests were conducted by *PANDUIT* to determine the acceptability for use in various areas of nuclear power plants (for radiation exposure accumulated over a 40 year life). See Cable Tie Selection Chart (pages B1.2 and B1.3) for radiation resistance rating.

Moisture

Many plastics when exposed to high relative humidity absorb water and, as such, the tensile strength of the material can change dramatically. Nylon 6.6 when exposed to 100% relative humidity, will absorb as much as 8.5% water which will reduce tensile strength by 50% when compared to a dry cable tie. Polypropylene, HALAR[▲], Type 12 Nylon, TEFZEL[■], Acetal and PEEK are low water absorbing materials and, as such, the effect of water is minimal. See Cable Tie Selection Chart (pages B1.2 and B1.3) for moisture absorption.

Proper Storage

Nylon 6.6 is a hygroscopic material (affected by atmospheric moisture variations). The optimum storage requirement for Nylon 6.6 cable ties is 73°F (± 15°F) and 50% RH (relative humidity) in sealed containers. Improper storage, especially in cold/dry conditions can result in moisture loss, which impedes cable tie performance. *PANDUIT* packaging provides Nylon 6.6 cable ties conditioned to 2.5% moisture added by weight in heavy-wall, polyethylene heat-sealed bags.

Temperature

Plastic materials normally undergo property loss due to oxidation caused by exposure to high temperatures. The maximum continuous use temperature for cable tie materials depends upon the time at the elevated temperature as well as other environmental conditions. Initially, plastics become more flexible and weaker when exposed to high temperatures. After a period of time, oxidation may occur which will cause embrittlement, making plastic cable ties more susceptible to failure from impact and vibration.

The maximum continuous use temperature, is based on the UL Relative Thermal Index (mechanical without impact) as determined by UL per UL 746B. It is one indicator of a material's ability to retain a particular physical property when exposed to elevated temperatures over an extended period of time. It is based on the assumption that there is no loading, no chemical attack, and impact-free condition. The maximum continuous use temperatures for cable tie materials are listed in the Cable Tie Selection Chart (pages B1.2 and B1.3).

Low temperature exposure will also make most plastics more brittle during the exposure, but little property loss occurs when the material is returned to room temperatures. The minimum application use temperatures for cable tie materials are listed in the Cable Tie Selection Chart (pages B1.2 and B1.3).

Tensile Strength

Most cable ties are selected based on material, length, and minimum loop tensile strength. Minimum loop tensile strength was established under SAE Aerospace Standard AS23190. Each cable tie cross section (SM = Subminiature, M = Miniature, I = Intermediate, S = Standard, HS = Heavy-Standard, LH = Light-Heavy, H = Heavy and EH = Extra-Heavy) has a different loop tensile strength when tested per AS23190.

The cable tie is first conditioned at 49°C (120°F), 20% relative humidity for 24 hours, then the cable tie is installed on a split mandrel and the halves of the mandrel separated at a rate of 1 inch (25.4mm) per minute. The separating force required to unlock or break the cable tie is the loop tensile strength. Loop tensile strength is dependent both on the locking design and the tensile strength (psi) of the material. As an example, the tensile strength of polypropylene material is approximately 1/2 to 1/3 of Nylon 6.6; thus the loop tensile strength of a given cross section tie made of polypropylene would be much less than a tie made of Nylon 6.6. This is another property to be considered when selecting a cable tie. The various representative loop tensile strengths are listed in the Cable Tie Selection Chart (pages B1.2 and B1.3).

Halogen-Free

All *PANDUIT* cable ties (with the exception of TEFZEL[■] and HALAR[▲]) are halogen-free per IEC Specification 61249-2-21.

[▲]HALAR is a registered trademark of Solvay Solexis, Inc.

[■]TEFZEL is a registered trademark of E.I. du Pont de Nemours and Company.

A.
System
Overview

B1.
Cable Ties

B2.
Cable
Accessories

B3.
Stainless
Steel Ties

C1.
Wiring
Duct

C2.
Surface
Raceway

C3.
Abrasion
Protection

C4.
Cable
Management

D1.
Terminals

D2.
Power
Connectors

D3.
Grounding
Connectors

E1.
Labeling
Systems

E2.
Labels

E3.
Pre-Printed
& Write-On
Markers

E4.
Permanent
Identification

E5.
Lockout/
Tagout
& Safety
Solutions

F.
Index

Table C – Chemical Resistance Table

Many factors combine to determine the useful life of a cable tie material and none is as important as chemical exposure. Various chemicals will have different effects on plastics depending on such variables as chemical concentrations, temperature, stress and ultraviolet light. This table is an excellent guideline for the selection of the best cable tie material for various cable tie environments. It should be noted that the exposure for this chemical resistance chart is at 70°F (21°C).

Resistance of *PANDUIT* cable tie materials to chemical attack at 70°F (21°C)

A = Excellent

B = Satisfactory

C = Slight Attack

D = Attacked

— = Not Tested

¹ = Pitting occurs under some conditions

² = Attack may occur if sulfuric acid present

Aq. = Aqueous

C.S. = Cold Saturated

Agent	Percent Concentration	Nylon 6.6*	Nylon 12	Polypropylene	TEFZEL [■]	HALAR [▲]	PEEK	304 Stainless Steel	316 Stainless Steel
Acetaldehyde	90	B	—	C	A	A	A	—	—
Acetic Acid	97	D	D	A	A	A	A	A	A
Acetic Acid	10	C	B	A	A	A	—	A	A
Acetic Anhydride	90	—	B	A	A	A	—	A	A
Acetone	100	A	A	A	A	A	A	A	A
Acetophenone	100	—	—	B	A	A	—	A	A
Acetylene	100	—	—	A	A	A	A	A	A
Aluminum Chloride	10	B	A	A	A	A	A	D	C
Aluminum Fluoride	10	B	A	A	A	A	—	D	C
Aluminum Hydroxide	Aq. C.S.	—	A	A	A	A	—	A	A
Aluminum Potassium Sulfate	10	B	A	A	A	A	—	A ¹	A ¹
Ammonia	All	—	A	A	A	A	A	A	A
Ammonium Carbonate	1 to 5	—	A	—	A	A	—	A	A
Ammonium Chloride	10 to 25	D	A	A	A	A	A	A ¹	A
Ammonium Hydroxide	10	A	—	—	A	A	A	—	—
Ammonium Nitrate	100	—	A	A	A	A	A	A	A ¹
Ammonium Sulfate	10	—	A	A	A	A	A	E ¹	A
Amyl Acetate	100	—	—	C	A	A	A	A	A
Aniline	100	—	B	A	A	A	A	A	A
Antimony Trichloride	All	D	—	A	A	A	A	A	A
Arsenic Acid	1 to 80	—	—	A	A	A	—	A	A
Barium Carbonate	All	—	A	A	A	A	—	A	A
Barium Chloride	All	—	A	A	A	A	—	A ¹	A
Barium Sulfate	All	—	A	A	A	A	—	A	A
Barium Sulfide	All	—	A	A	A	A	—	A	A
Benzene	100	A	A	C	A	A	A	A	A
Benzoic Acid	100	D	A	A	A	A	A	A	A
Benzoyl Chloride	100	—	—	C	A	A	—	—	—
Benzyl Alcohol	100	—	—	A	A	A	A	—	—
Boric Acid	All	D	A	A	A	A	A	B	—
Bromine	100	D	D	D	A	A	D	D	D
Butadiene	100	—	—	C	A	A	—	A	A
Butane	100	—	A	A	A	A	A	A	A
Butanediol	100	—	—	A	A	A	—	—	—
Butyl Acetate	100	—	A	C	A	A	A	—	—
N. Butyl Alcohol	100	—	A	A	A	A	A	A	A
Butyl Phthalate	100	—	—	A	A	A	—	—	—
Butyraldehyde	100	—	—	A	A	A	—	—	—
Butyric Acid	10 to 100	D	—	A	A	A	—	A	A
Calcium Carbonate	Aq. C.S.	—	—	A	A	A	A	A	A
Calcium Chlorate	Aq. C.S.	—	—	A	A	A	—	A	A

*Includes all 6.6 Nylons (weather resistant, heat stabilized, and flame retardant).

■TEFZEL is a registered trademark of E.I. du Pont de Nemours and Company.

▲HALAR is a registered trademark of Solvay Solexis, Inc.

Agent	Percent Concentration	Nylon 6.6*	Nylon 12	Polypropylene	TEFZEL [®]	HALAR [®]	PEEK	304 Stainless Steel	316 Stainless Steel
Calcium Chloride	5	C	A	A	A	A	A	A ¹	A ¹
Calcium Hydroxide	50	—	—	A	A	A	A	A	A
Calcium Hypochlorite	2	D	—	A	A	A	A	A ¹	A ¹
Calcium Nitrate	50	—	A	A	A	A	A	—	—
Calcium Sulfate	2	C	—	A	A	A	A	A	A
Carbon Tetrachloride	100	A	A	D	A	A	A	A	A
Carbon Tetrachloride	Aq. 10	—	—	—	—	A	—	C ¹	A ¹
Chlorine	Dry	—	D	D	A	A	D	C	C
Chlorine	Wet	—	D	C	A	A	D	D	D
Chloroacetic Acid	10 to 50	D	—	A	A	A	A	D	C
Chlorobenzene	100	—	C	A	A	A	A	—	—
Chloroform	100	A	C	C	A	A	A	A	A
Chlorosulphonic Acid	10 to 100	D	D	D	B	A	D	D	D
Chromic Acid	10 to 50	D	D	A	A	A	A	C	C
Citric Acid	10 to 50	B	B	A	—	A	A	A	A
Copper Chloride	1 to 10	D	—	A	A	A	A	A ¹ -D	A ¹ -C ¹
Copper Cyanide	Aq. C.S.	—	—	A	A	A	A	A	A
Copper Nitrate	50	—	—	A	A	A	A	A	A
Cresol	100	D	D	—	A	A	—	A	A
Crotonaldehyde	100	—	—	A	A	A	—	—	—
Cyclohexane	100	—	A	C	A	A	A	A	—
Cyclohexanol	100	—	A	A	A	A	A	A	—
Cyclohexanone	100	—	A	C	A	A	A	A	—
Dibutyl Phthalate	100	—	—	A	A	A	A	—	—
Dichloroethane	100	—	—	A	—	A	A	A	A
Dichloroethylene	100	—	—	C	A	A	—	—	—
Diesel Fuel	100	—	A	C	A	A	A	A	A
Diethyl Ether	100	—	A	A	A	A	A	A	A
Diglycolic Acid	Aq. C.S.	—	—	A	A	A	—	—	—
Diisobutyl Ketone	100	—	—	A	A	A	—	—	—
Dimethyl Amine	100	—	—	A	A	A	—	—	—
Dimethyl Formamide	100	—	A	A	A	A	A	A	—
Dimethyl Sulfate	100	—	—	C	A	A	—	—	—
Diocetyl Phthalate	100	—	—	A	A	A	A	A	—
1,4-Dioxane	100	—	B	C	A	A	A	A	—
Ethyl Acetate	100	A	A	B	A	A	A	A	A
Ethyl Alcohol	100	A	A	A	A	A	A	A	A
Ethyl Chloride	100	—	—	C	A	A	—	A	A
Ethylene Chloride	100	A	C	C	A	A	—	A	A
Ethylene Glycol	100	A	A	A	A	A	A	A	A
Ethylene Oxide	100	—	—	C	A	A	A	—	—
Fatty Acids	100	—	—	A	A	A	—	—	—
Ferric Chloride	50	D	—	A	A	A	C	D	D
Ferric Hydroxide	All	—	—	A	A	A	—	A	A
Ferric Nitrate	All	—	—	A	A	A	A	A	A
Ferrous Chloride	Aq. C.S.	D	—	A	A	A	A	D	C
Ferrous Sulfate	10	—	—	A	A	A	A	A ¹	A
Fluorine (Dry)	100	—	—	D	A	—	D	D	D
Formaldehyde	40	A	B	A	A	A	A	A ¹	A
Formic Acid	All	D	D	A	A	A	C	A	A
Freons	100	A	—	—	A	A	A	—	—
Fuel Oil	100	—	A	—	A	A	A	A	A
Furfural	100	A	—	—	A	A	—	A	A
Gallic Acid	Aq. C.S.	—	—	—	A	A	—	A	A
Gasoline	100	A	—	C	A	A	A	A	A
Glycerin	100	—	A	A	—	A	—	A	A
Glycolic Acid	40	D	—	A	A	A	—	—	—
Heptane	100	—	A	A	A	A	A	A	A
Hexane	100	—	A	A	A	A	A	A	A
Hydrobromic Acid	All	D	D	A	A	A	D	D	D

*Includes all 6.6 Nylons (weather resistant, heat stabilized, and flame retardant).

[®]TEFZEL is a registered trademark of E.I. du Pont de Nemours and Company.

[®]HALAR is a registered trademark of Solvay Solexis, Inc.

Table continues on page B1.104

A.
System
Overview

B1.
Cable Ties

B2.
Cable
Accessories

B3.
Stainless
Steel Ties

C1.
Wiring
Duct

C2.
Surface
Raceway

C3.
Abrasion
Protection

C4.
Cable
Management

D1.
Terminals

D2.
Power
Connectors

D3.
Grounding
Connectors

E1.
Labeling
Systems

E2.
Labels

E3.
Pre-Printed
& Write-On
Markers

E4.
Permanent
Identification

E5.
Lockout/
Tagout
& Safety
Solutions

F.
Index

Table C – Chemical Resistance Table (continued)

	Agent	Percent Concentration	Nylon 6.6*	Nylon 12	Polypropylene	TEFZEL [■]	HALAR [▲]	PEEK	304 Stainless Steel	316 Stainless Steel
A. System Overview	Hydrochloric Acid	All	D	D	A	A	A	A	D	D
	Hydrocyanic Acid	All	—	D	A	A	A	A	C	C
B1. Cable Ties	Hydrofluoric Acid	All	D	D	A	A	A	D	D	D
	Hydrofluorosilicic Acid	30	—	D	A	A	A	—	D	D
B2. Cable Accessories	Hydrogen Peroxide	30	D	B	B	A	A	A	B	A
	Hydrogen Sulfide	Dry	—	—	A	A	A	A	A	A
B3. Stainless Steel Ties	Hydrogen Sulfide	Wet	D	—	A	A	A	—	C ²	A ²
	Hydroquinone	100	—	—	A	A	A	—	—	—
C1. Wiring Duct	Iodine	100	—	—	A	A	A	C	D	D
	Iodoform	100	—	—	—	A	A	—	A	A
C2. Surface Raceway	Isopropyl Alcohol	100	A	A	A	A	A	A	A	A
	Jet Fuel	100	A	—	A	A	A	A	A	A
C3. Abrasion Protection	Lactic Acid	10	A	B	A	A	A	—	A	A
	Lanolin	10	A	A	A	A	A	—	A	A
C4. Cable Management	Lead Acetate	Aq. C.S.	—	—	A	A	A	A	A	A
	Linseed Oil	100	A	A	A	A	A	—	A	A
D1. Terminals	Magnesium Carbonate	Aq. C. S.	—	A	A	A	A	—	A	A
	Magnesium Chloride	Aq. C.S.	C	A	A	A	A	A	A ¹	A ¹
D2. Power Connectors	Magnesium Nitrate	Aq. C. S.	—	A	A	A	A	—	A	A
	Maleic Acid	100	—	—	A	A	A	A	—	—
D3. Grounding Connectors	Malic Acid	Aq. C.S.	—	—	A	A	A	—	A	A
	Mercuric Chloride	Dilute	—	A	A	A	A	A	D	D
E1. Labeling Systems	Mercury	100	—	A	A	A	A	A	A	A
	Methyl Alcohol	100	A	A	A	A	A	A	A	A
E2. Labels	Methyl Bromide	100	—	—	D	A	A	—	—	—
	Methyl Chloride	100	—	—	C	A	A	—	—	A
E3. Pre-Printed & Write-On Markers	Methyl Chloroform	100	A	—	C	A	A	—	—	—
	Methyl Ethyl Ketone	100	—	A	C	A	A	A	A	A
E4. Permanent Identification	Methyl Isobutyl Ketone	100	A	—	C	A	A	—	A	A
	Methylene Chloride	100	C	D	C	A	A	A	A	A
E5. Lockout/Tagout & Safety Solutions	Naphtha	100	—	—	A	A	A	A	A	A
	Naphthalene	100	—	B	A	A	A	A	A	A
F. Index	Nickel Chloride	Aq. C.S.	—	A	A	A	A	A	A ¹	A ¹
	Nickel Sulfate	Aq. C.S.	—	A	A	A	A	A	A ¹	A ¹
	Nitric Acid	10 to 30	D	D	A	A	A	—	A	A
	Nitric Acid	30 to 68	D	D	D	B	A	C	A	A
	Nitro Benzene	100	—	C	C	A	A	A	A	A
	Nitro Methane	100	A	—	—	A	A	—	—	—
	Nitrous Acid	5	—	—	—	A	A	A	A	A
	Oleic Acid	100	—	C	A	A	A	A	A	A
	Oxalic Acid	10	—	C	A	A	A	A	A	A
	Oxygen	All	—	—	A	A	A	A	—	—
	Paraffin	100	A	A	A	A	A	—	A	A
	Perchloroethylene	100	—	—	C	A	A	A	A	A
	Petroleum Ether	100	—	A	A	A	A	A	A	A
	Phenol	90	D	D	A	A	A	D	A	A
	Phosphoric Acid	10	D	D	A	A	A	A	A	A
	Phosphorous Pentoxide	100	—	D	A	A	A	A	—	—
	Phosphorous Trichloride	100	—	D	C	A	A	—	A	A
	Phthalic Acid	50	—	—	C	A	A	—	A	A
	Picric Acid	1	—	—	A	A	A	A	A	A
	Potassium Borate	1	—	—	A	A	A	—	—	—
	Potassium Bromide	Aq. C.S.	—	—	A	A	A	A	A ¹	A ¹
	Potassium Carbonate	Aq. C.S.	—	C	A	A	A	A	A	A
	Potassium Chlorate	Aq. C. S.	—	B	A	A	A	A	A	A
	Potassium Chloride	5	—	A	A	A	A	A	A ¹	A ¹
	Potassium Dichromate	Aq. C.S.	—	D	A	A	A	A	A	A
	Potassium Ferrocyanide	25	—	—	A	A	A	A	A	A
	Potassium Hydroxide	30	C	—	A	A	A	A	C	C

*Includes all 6.6 Nylons (weather resistant, heat stabilized, and flame retardant).

■TEFZEL is a registered trademark of E.I. du Pont de Nemours and Company.

▲HALAR is a registered trademark of Solvay Solexis, Inc.

Agent	Percent Concentration	Nylon 6.6*	Nylon 12	Polypropylene	TEFZEL [■]	HALAR [▲]	PEEK	304 Stainless Steel	316 Stainless Steel
Potassium Iodide	Aq. C.S.	—	A	A	—	A	—	A	A
Potassium Nitrate	Aq. C.S.	—	A	A	A	A	A	A	A
Potassium Perchlorate	1	—	—	A	A	A	—	—	—
Potassium Permanganate	5	D	D	A	A	A	A	A	A
Potassium Persulfate	All	—	—	A	A	A	—	—	—
Potassium Sulfate	Aq. C.S.	—	A	A	A	A	A	A	A
Potassium Sulfide	Aq. C.S.	—	—	A	A	A	A	A	A
Propionic Acid	50	—	—	A	A	A	—	—	—
Propyl Alcohol	100	A	—	A	A	A	A	A	A
Pyridine	100	—	A	C	A	A	A	C	C
Sea Water	100	—	A	A	A	A	—	A ¹	A ¹
Silver Chloride	Aq. C.S.	—	A	A	A	A	—	D	D
Silver Nitrate	10	—	A	A	A	A	A	A	A
Sodium Acetate	Aq. C.S.	A	—	A	A	A	A	A ¹	A
Sodium Benzoate	Aq. C.S.	—	—	A	A	A	—	—	—
Sodium Bicarbonate	Aq. C.S.	A	A	A	A	A	A	A	A
Sodium Bisulfate	10	—	—	A	A	A	—	A	A
Sodium Bisulfite	Aq. C.S.	—	B	A	A	A	—	A	A
Sodium Borate	Aq. C.S.	—	—	A	A	A	—	A	A
Sodium Carbonate	2	A	A	A	A	A	A	A	A
Sodium Chlorate	25	—	C	A	A	A	A	A	A
Sodium Chloride	10	A	A	A	A	A	A	A ¹	A ¹
Sodium Chromate	Aq. C.S.	D	—	A	A	A	—	A	A
Sodium Fluoride	5	—	—	A	A	A	—	A ¹	A ¹
Sodium Hydroxide	10	A	A	A	A	A	A	A	A
Sodium Hypochlorite	5	B	C	A	A	A	A	C ¹	A ¹
Sodium Hyposulfite	Aq.C.S.	—	—	—	A	A	—	A	A
Sodium Nitrate	5	A	A	A	A	A	A	A	A
Sodium Perborate	Aq. C.S.	—	B	A	A	A	—	—	C
Sodium Perchlorate	10	—	—	—	A	A	—	A	A
Sodium Phosphate	5	—	A	A	A	A	—	A	A
Sodium Sulfate	5	—	A	A	A	A	A	A	A
Sodium Sulfide	5	—	A	A	A	A	A	A ¹	A
Sodium Thiosulfate	25	—	A	A	A	A	—	A ²	A ²
Stannic Chloride	Aq. C.S.	D	—	A	A	A	A	D	C
Stannous Chloride	Aq. C.S.	—	A	A	A	A	A	C	B
Stearic Acid	100	—	C	A	A	A	—	A	A
Succinic Acid	100	—	B	A	A	A	—	—	—
Sulfur	100	—	A	A	A	A	A	B	C
Sulfur Dioxide	All	D	—	C	A	A	A	A	A
Sulfuric Acid	5	D	C	A	A	A	C	C	A
Sulfuric Acid	50	D	D	A	A	A	D	D	C
Sulfuric Acid	Concentrate	D	D	C	A	A	D	C	C
Sulfurous Acid	10	A	—	A	A	A	A	C ¹	A ¹
Tannic Acid	10	—	A	A	A	A	A	A	A
Tartaric Acid	50	—	B	A	A	A	A	A	A
Tetrahydrofuran	100	—	C	C	A	A	A	A	A
Toluene	100	A	A	C	A	A	A	A	A
Trichloroacetic Acid	10	D	—	B	A	A	—	D	D
Trichloroethylene	100	—	D	C	A	A	A	A ¹	A ¹
Turpentine	100	—	B	D	A	A	A	A	A
Urea	50	—	A	A	A	A	—	—	—
Vinyl Acetate	100	—	—	A	A	A	—	—	—
Xylene	100	A	—	D	A	A	A	A	A
Zinc Chloride	70	D	A	A	A	A	A	A	A
Zinc Nitrate	Aq. C.S.	—	A	A	A	A	—	A	A
Zinc Sulfate	Aq. C.S.	—	A	A	A	A	A	A	A

*Includes all 6.6 Nylons (weather resistant, heat stabilized, and flame retardant).

■TEFZEL is a registered trademark of E.I. du Pont de Nemours and Company.

▲HALAR is a registered trademark of Solvay Solexis, Inc.

A.
System
Overview

B1.
Cable Ties

B2.
Cable
Accessories

B3.
Stainless
Steel Ties

C1.
Wiring
Duct

C2.
Surface
Raceway

C3.
Abrasion
Protection

C4.
Cable
Management

D1.
Terminals

D2.
Power
Connectors

D3.
Grounding
Connectors

E1.
Labeling
Systems

E2.
Labels

E3.
Pre-Printed
& Write-On
Markers

E4.
Permanent
Identification

E5.
Lockout/
Tagout
& Safety
Solutions

F.
Index

A.
System
Overview

B1.
Cable Ties

B2.
Cable
Accessories

B3.
Stainless
Steel Ties

C1.
Wiring
Duct

C2.
Surface
Raceway

C3.
Abrasion
Protection

C4.
Cable
Management

D1.
Terminals

D2.
Power
Connectors

D3.
Grounding
Connectors

E1.
Labeling
Systems

E2.
Labels

E3.
Pre-Printed
& Write-On
Markers

E4.
Permanent
Identification

E5.
Lockout/
Tagout/
& Safety
Solutions

F.
Index

NOTES

MANUAL CABLE TIE INSTALLATION TOOLS

PANDUIT provides the most preferred hand-operated tools in the industry.

These versatile tools can be used for production, maintenance, or construction applications.



PANDUIT cable tie installation tools promote worker safety, help reduce downtime, improve productivity and provide the lowest total installed cost. As with all PANDUIT products, quality in design and production along with customer service excellence, are assured.

Tool Highlights:

- Tool controlled tension and cut-off
 - Ergonomic tools are durable, lightweight, and easy to use
 - Manual tools
 - Pneumatic tools
- Installer controlled tension and cut-off
 - Large selection of tools available for complete range of PANDUIT cable ties
 - Cost-effective alternative for small volume applications

A.
System
Overview

B1.
Cable
Ties

B2.
Cable
Accessories

B3.
Stainless
Steel Ties

C1.
Wiring
Duct

C2.
Surface
Raceway

C3.
Abrasion
Protection

C4.
Cable
Management

D1.
Terminals

D2.
Power
Connectors

D3.
Grounding
Connectors

E1.
Labeling
Systems

E2.
Labels

E3.
Pre-Printed
& Write-On
Markers

E4.
Permanent
Identification

E5.
Lockout/
Tagout
& Safety
Solutions

F.
Index

A. System Overview

Selection Guide – Hand Tools, Accessories, and Kits

Hand Tools

Manual

Tool Controlled Tension and Cut-Off

Recommended usage: under 50,000 ties/year

Typical applications: Low to medium volume tie usage in OEM, MRO, or construction

Cross Section	Tool Part Number – Page B1.109					
	GTS	GTSL	GS2B	GTH	GS4H	GS4EH
SM	X	X				
M	X	X	X			
I	X	X	X			
S	X	X	X	X	X	
HS				X	X	
LH				X	X	X
H				X	X	X
EH						X

Cross Sections	
SM	= Subminiature
M	= Miniature
I	= Intermediate
S	= Standard
HS	= Heavy-Standard
LH	= Light-Heavy
H	= Heavy
EH	= Extra-Heavy

Installer Controlled Tension and Cut-Off

Recommended usage: under 10,000 ties/year

Typical applications: MRO or construction

Cross Section	Tool Part Number – Page B1.110			
	STS2	STH2	ST3EH	STHV
M	X			
I	X			
S	X	X		
HS		X		
LH		X	X	X
H		X	X	X
EH			X	

Pneumatic

Recommended usage: under 250,000 ties/year

Typical applications: Medium to high volume tie usage in OEM

Cross Section	Tool Part Number – Page B1.111	
	PTS	PTH
SM	X	
M	X	
I	X	
S	X	X
HS		X
LH		X
H		X

Accessories/Kits

Manual

	Part Number	For Tool	Page
Tool Tension Locking Kits	KGSTL	GTS, GTSL	B1.112
	KGHTL	GTH	B1.112
	TTLK3	GS2B, GS4H	B1.112
Blade Replacement Kits	KGTSBLD	GTS, GTSL	B1.112
	KGTHBLD	GTH	B1.112
	K2-BLD2	GS2B	B1.112
	K4H-BLD	GS4H	B1.112
Tool Holster	GHH	GTS, GTSL, GS2B, GTH, GS4H, GS4EH	B1.112
Cushion Sleeve Kit	KGTSBLV	GTS	B1.112
	KGTHSLV	GTH	B1.112
Pneumatic Hose Assembly, Filter/Regulator, Adapter Fittings			

Pneumatic

Part Number	For Tool	Page
KPTSTL	PTS, PTH	B1.112
TTLK3	PPTS	B1.112
KGTSBLD	PTS	B1.112
KPTHBLD	PTH	B1.112
K2-BLD2	PPTS	B1.112
GHH	PTS, PPTS	B1.112
PPH10	PTS, PTH, PPTS	B1.111
PL289N1		B1.111
PHCAQ		B1.111
PHCAT		B1.111

Cable Tie Tools – Tool Controlled Tension and Cut-Off



GTS

- Used in production, maintenance, or construction applications
- Tool controlled tension provides flush cut-off and speeds installation to lower installed cost
- Lightweight and balanced
- Easy to change tension adjustment and easy to operate
- A combination of design, operation, and construction features, provides a long service life
- Replacement blades available, see page B1.112
- No special maintenance required



GTS



GTSL



GS2B



GTH



GS4H



GS4EH

Part Number	Used with Cable Ties	Weight		Part Features	Standards	Std. Pkg. Qty.
		Oz.	g			
GTS	SM, M, I, S	9.8	278	Ergonomic design with impact resistant resin housing, narrow nose, and cushion handle.	QPL per Mil. Std. MS90387-1 and Mil. Spec. MIL-T-81306A	1
GTSL	SM, M, I, S	8.8	249	Ergonomic design with impact resistant resin housing, narrow nose, and cushion handle. Shorter handle reach (than GTS) for users with smaller hands.	QPL per Mil. Std. MS90387-1 and Mil. Spec. MIL-T-81306A	1
GS2B	M, I, S	11.5	327	Metal tool with a durable powder coat finish.	QPL per Mil. Std. MS90387-1 and Mil. Spec. MIL-T-81306A	1
GTH	S, HS, LH, H	12.0	340	Ergonomic design with impact resistant resin housing, narrow nose, and cushion handle.	—	1
GS4H	S, HS, LH, H	16.0	454	Metal tool with a durable powder coat finish.	QPL per Mil. Std. MS90387-2 and Mil. Spec. MIL-T-81306A	1
GS4EH	LH, H, EH	16.0	454	Metal tool with a durable powder coat finish.	—	1

Cable tie cross section sizes: SM = Subminiature, M = Miniature, I = Intermediate, S = Standard, HS = Heavy-Standard, LH = Light-Heavy, H = Heavy, EH = Extra-Heavy.

A.
System
Overview

B1.
Cable Ties

B2.
Cable
Accessories

B3.
Stainless
Steel Ties

C1.
Wiring
Duct

C2.
Surface
Raceway

C3.
Abrasion
Protection

C4.
Cable
Management

D1.
Terminals

D2.
Power
Connectors

D3.
Grounding
Connectors

E1.
Labeling
Systems

E2.
Labels

E3.
Pre-Printed
& Write-On
Markers

E4.
Permanent
Identification

E5.
Lockout/
Tagout
& Safety
Solutions

F.
Index

A.
System
Overview

Cable Tie Tools – Installer Controlled Tension and Cut-Off

B1.
Cable Ties

B2.
Cable
Accessories

B3.
Stainless
Steel Ties



STS2

- Economical series of tools for maintenance or construction applications
- Excellent tools for low volume applications

C1.
Wiring
Duct



STS2

C2.
Surface
Raceway



STH2

C3.
Abrasion
Protection



ST3EH

C4.
Cable
Management

D1.
Terminals

D2.
Power
Connectors

D3.
Grounding
Connectors



STHV

E1.
Labeling
Systems

E2.
Labels

E3.
Pre-Printed
& Write-On
Markers

E4.
Permanent
Identification

E5.
Lockout/
Tagout/
& Safety
Solutions

F.
Index

Part Number	Used with Cable Ties	Color	Weight		Part Features	Std. Pkg. Qty.
			Oz.	g		
STS2	M, I, S	Black	2.5	71	Economical tool with short handle span and top loading feature for right- or left-handed users.	1
STH2	S, HS, LH, H	Red	2.5	71	Economical tool with short handle span and top loading feature for right- or left-handed users.	1
ST3EH	LH, H, EH	Blue/Black	9.0	256	Durable, all steel construction with comfortable plastic handles.	1
STHV	LH, H	Yellow	12.0	341	Durable all steel construction and "travel stop" to prevent pinched fingers.	1

Cable tie cross section sizes: SM = Subminiature, M = Miniature, I = Intermediate, S = Standard, HS = Heavy-Standard, LH = Light-Heavy, H = Heavy, EH = Extra-Heavy.

Installation Procedure (STS2/STH2/ST3EH):
Install cable tie around bundle and tension tie by squeezing tool handle. Reduce tension slightly and twist tool 1/4" turn either direction to cut off excess cable tie.

Installation Procedure (STHV):
Install cable tie around bundle and tension tie by squeezing tool handle. A separate lever cuts off excess cable tie.

Pneumatic Hand Tools – Tool Controlled Tension and Cut-Off



PTS

- Pneumatic, push button operation tensions and cuts off excess tie in a fraction of a second
- Durable, lightweight, ergonomic design is easy to operate and designed to reduce operator fatigue
- Easy to change tension adjustment
- Operates on non-lubricated air, without special maintenance



PTS



PTH

Part Number	Used with Cable Ties	Weight		Part Features	Std. Pkg. Qty.
		Oz.	g		
PTS	SM, M, I, S	17.3	490	Ergonomic design with impact resistant resin housing and black knob; replacement parts can be part of a scheduled maintenance program.	1
PTH	S, HS, LH, H	32.0	907	Ergonomic design with impact resistant resin housing and red knob; replacement parts can be part of a scheduled maintenance program.	1

Note: All tools require the PPH10 hose and PL289N1 filter/regulator for proper operation.

Cable tie cross section sizes: SM = Subminiature, M = Miniature, I = Intermediate, S = Standard, HS = Heavy-Standard, LH = Light-Heavy, H = Heavy.

Pneumatic Tool Accessories



PL289N1/PPH10



PHCAQ



PHCAT

Part Number	Used with Installation Tool	Part Description	Std. Pkg. Qty.
PL289N1	PTS, PPTS, PTH	Filter/regulator .5 micron element, regulated range 3 – 100 psig, features 1/8" NPT female output port (to hose PPH10) and 1/4" male quick disconnect to source air line.	1
PPH10	PTS, PPTS, PTH	10.0' (3m) hose assembly (regulator to tool); includes a 1/8" NPT male connector (to regulator) and 1/8" female quick disconnect (to tool).	1
PHCAQ	PTS, PPTS, PTH	Adapter fitting for 10.0' (3m) hose (PPH10) to regulator with 1/4" female quick disconnect output, features 1/8" NPT female connection (to hose) and 1/4" male quick disconnect (to regulator).	1
PHCAT	PTS, PPTS, PTH	Adapter fitting for 10.0' (3m) hose (PPH10) to regulator with 1/4" NPT female output port, features 1/8" NPT female connection (to hose) and 1/4" NPT male connection (to regulator).	1

A. System Overview

B1. Cable Ties

B2. Cable Accessories

B3. Stainless Steel Ties

C1. Wiring Duct

C2. Surface Raceway

C3. Abrasion Protection

C4. Cable Management

D1. Terminals

D2. Power Connectors

D3. Grounding Connectors

E1. Labeling Systems

E2. Labels

E3. Pre-Printed & Write-On Markers

E4. Permanent Identification

E5. Lockout/Tagout & Safety Solutions

F. Index

A.
System
Overview

Hand Tool Accessories: Tool Tension Locking Kits

B1.
Cable Ties

- For applications requiring a locking device on either the selector knob (one cross section size and tension only) or tension level adjustment (but allow cross section size changes)



KGTHL

Part Number	Used with Installation Tool	Contents	Std. Pkg. Qty.
KGSTL	GTS, GTSL	Lockout cap and screw.	1
KGHTL	GTH	Lockout cap and screw.	1
KPTSTL	PTS, PTH	Lockout cap and screw.	1
TTLK3	GS2B, GS4H, PPTS	Selection locking clip and screws.	1

C1.
Wiring
Duct

Blade Replacement Kits

C2.
Surface
Raceway

- Blade replacement kits can be part of a user's scheduled maintenance plan or used when cut-offs are not clean and crisp



KGTSBLD

Part Number	Used with Installation Tool	Contents	Std. Pkg. Qty.
KGTSBLD	GTS, GTSL, PTS	Threadlocker, screw, washer and replacement blade.	1
KGTHBLD	GTH	Threadlocker, screw, and replacement blade.	1
K2-BLD2	GS2B, PPTS	Threadlocker, screws, and replacement blade.	1
K4H-BLD	GS4H	Threadlocker, screws, and replacement blade.	1
K4EH-BLD	GS4EH	Threadlocker, screw, and replacement blade.	1
KPTHBLD	PTH	Threadlocker, screw, and replacement blade.	1

C3.
Abrasion
Protection

C4.
Cable
Management

D1.
Terminals

Hand Tool Holster

D2.
Power
Connectors

- Durable leather construction holster with rivets and extra tie-down strap to hold tool in place – easily fits on belt



Part Number	Used with Installation Tool	Color	Std. Pkg. Qty.
GHH	GTS, GTSL, GS2B, GTH, GS4H, GS4EH, PTS, PPTS, ST3EH	Black	1

D3.
Grounding
Connectors

E1.
Labeling
Systems

E2.
Labels

NEW! Cushion Sleeve Kits

E3.
Pre-Printed
& Write-On
Markers

- Cushion sleeve can be added to existing GTS or GTH hand tool
- Reduce the amount of shock an operator may experience while tensioning and cutting off cable ties
- Reduce operator fatigue
- Unique thermoplastic elastomer material that won't split or fall off the tool over time



KGTSVLV

Part Number	Used with Installation Tool	Color	Contents	Std. Pkg. Qty.
KGTSVLV	GTS	Black	Cushion sleeve and lubricant.	1
KGTHSVLV	GTH	Red	Cushion sleeve and lubricant.	1

E4.
Permanent
Identification

E5.
Lockout/
Tagout/
& Safety
Solutions

F.
Index

AUTOMATIC CABLE TIE INSTALLATION SYSTEMS



The complete line of *PANDUIT* automatic cable tie installation systems offers a superior solution for high volume harness, assembly, fastening and packaging applications. These ergonomic systems increase productivity, provide consistent performance, and reduce activities that lead to repetitive motion injuries. A variety of tool options provide users with flexible solutions for their unique application needs.



System Highlights

Three systems improve productivity, reliability, and versatility:

- Install a cable tie in less than one second
- Multiple cable tie styles and sizes for maximum productivity
- Optional software for advanced system monitoring and performance



Combined, these innovations improve reliability, maximize productivity, and lower installed costs. As with all *PANDUIT* products, quality in design and production along with customer service excellence, are assured.

A.
System
Overview

B1.
Cable Ties

B2.
Cable
Accessories

B3.
Stainless
Steel Ties

C1.
Wiring
Duct

C2.
Surface
Raceway

C3.
Abrasion
Protection

C4.
Cable
Management

D1.
Terminals

D2.
Power
Connectors

D3.
Grounding
Connectors

E1.
Labeling
Systems

E2.
Labels

E3.
Pre-Printed
& Write-On
Markers

E4.
Permanent
Identification

E5.
Lockout/
Tagout/
& Safety
Solutions

F.
Index

A.
System
Overview

Selection Guide – Automatic Installation Systems and Reel-Fed Cable Ties

B1.
Cable Ties

Recommended for annual usage of over 250,000 cable ties/year
Typical applications: High volume OEM/contract manufacturing

B2.
Cable
Accessories

PAT1M/PAT1.5M Systems

Tool Head for use with MINIATURE Cross Section

Part Number	Description	Page
PAT1M	For miniature cross section up to .82" (21mm) bundle diameter	B1.115
PAT1.5M	For miniature cable ties up to 1.31" (33mm) bundle diameter	B1.115

Dispenser

Part Number	Description	Page
PDM	Stationary dispenser	B1.115
PDM-DI	Dispenser and data interface software	B1.117
PD-DIA	Data interface accessory – software and interface card	B1.117

Transfer Hose

Part Number	Description	Page
PHM1	3.2' (1m) transfer hose	B1.116
PHM2	6.5' (2m) transfer hose	B1.116
PHM3	10.0' (3m) transfer hose	B1.116
PHM4	13.1' (4m) transfer hose	B1.116

Optional System Accessories

Part Number	Description	Page
PDH10-37	Air hose	B1.117
PL283N1	Filter/regulator	B1.117
PATMBM	Bench mount and foot pedal	B1.117

Reel-Fed Cable Ties

MINIATURE Cross Section

Part Number	Description	Color	Page
Barbed Tie – Max. Bundle Dia.: .82" (21mm), 30 lbs.			
BT1M-XMR	Nylon 6.6	Natural	B1.118
BT1M-XMR0	Weather Resistant Nylon 6.6	Black	B1.118
BT1M-XMR30	Heat Stabilized Nylon 6.6	Black	B1.118
Barbed Tie – Max. Bundle Dia.: 1.31" (33mm), 30 lbs.			
BT1.5M-XMR	Nylon 6.6	Natural	B1.118
BT1.5M-XMR0	Weather Resistant Nylon 6.6	Black	B1.118
BT1.5M-XMR30	Heat Stabilized Nylon 6.6	Black	B1.118
BT1.5M-XMR69	Flame Retardant Nylon 6.6	Natural Ivory	B1.118
All-Nylon Tie – Max. Bundle Dia.: .82" (21mm), 18 lbs.			
PLT1M-XMR	Nylon 6.6	Natural	B1.119
PLT1M-XMR0	Weather Resistant Nylon 6.6	Black	B1.119
PLT1M-XMR00	Weather Resistant Nylon 6.6 (Meets Mil Spec)	Black	B1.119
PLT1M-XMR30	Heat Stabilized Nylon 6.6	Black	B1.119
All-Nylon Tie – Max. Bundle Dia.: 1.31" (33mm), 18 lbs.			
PLT1.5M-XMR	Nylon 6.6	Natural	B1.119
PLT1.5M-XMR0	Weather Resistant Nylon 6.6	Black	B1.119
PLT1.5M-XMR00	Weather Resistant Nylon 6.6 (Meets Mil Spec)	Black	B1.119
PLT1.5M-XMR30	Heat Stabilized Nylon 6.6	Black	B1.119

PAT2S System

Tool Head for use with STANDARD Cross Section

Part Number	Description	Page
PAT2S	For standard cross section up to 2.00" (51mm) bundle diameter	B1.115

Dispenser

Part Number	Description	Page
PDS	Stationary dispenser	B1.115
PDS-DI	Dispenser and data interface software	B1.117
PD-DIA	Data interface accessory – software and interface card	B1.117

Transfer Hose

Part Number	Description	Page
PHS2	6.5' (2m) transfer hose	B1.116
PHS3	10.0' (3m) transfer hose	B1.116

Dispenser Frame

Part Number	Description	Page
PDSF	Dispenser frame	B1.116

Optional System Accessories

Part Number	Description	Page
PDH10-37	Air hose	B1.117
PL283N1	Filter/regulator	B1.117
PAT2SBM	Bench mount and foot pedal	B1.117

Reel-Fed Cable Ties

STANDARD Cross Section

Part Number	Description	Color	Page
All-Nylon Tie – Max. Bundle Dia.: 2.00" (51mm), 50 lbs.			
PLT2S-VMR	Nylon 6.6	Natural	B1.120
PLT2S-VMR0	Weather Resistant Nylon 6.6	Black	B1.120
PLT2S-VMR00	Weather Resistant Nylon 6.6 (Meets Mil Spec)	Black	B1.120
PLT2S-VMR30	Heat Stabilized Nylon 6.6	Black	B1.120

System Selection Guide

Maximum Bundle Dia.		Tool Head	Dispenser/Frame	Transfer Hose	Reel-Fed Cable Ties
In.	mm				
.82	21	PAT1M	PDM	PHM1, PHM2, PHM3, PHM4	BT1M-XMR, PLT1M-XMR
1.31	33	PAT1.5M	PDM		BT1.5M-XMR, PLT1.5M-XMR
2.00	51	PAT2S	PDS/PDSF	PHS2, PHS3	PLT2S-VMR

Tool Head – Three Sizes Accommodate a Wide Variety of Applications

- Ergonomic, lightweight design reduces operator fatigue and repetitive motion injuries – no counter balance required
- Right or left hand operation
- Durable, one-piece cable tie tip collector (for cut-off tips)
- Includes tension adjustment
- Built-in safety interlock prevents false triggering if anything obstructs jaw path



PAT1M



PAT1.5M



PAT2S

Part Number	Max. Bundle Dia.		Dispenser/Frame	Transfer Hose	Used with Cable Ties	Std. Pkg. Qty.
	In.	mm				
PAT1M	.82	21	PDM	PHM1, PHM2, PHM3, PHM4	PLT1M-XMR, BT1M-XMR	1
PAT1.5M	1.31	33	PDM		PLT1.5M-XMR, BT1.5M-XMR	1
PAT2S	2.00	51	PDS/PDSF	PHS2, PHS3	PLT2S-VMR	1

Dispenser

- Microprocessor based controller monitors system performance through LCD display; provides production data and reporting, including error detection and cycle count for improved reliability
- Online HELP menu through LCD display in five languages (English, Spanish, German, Italian or French), is user-friendly for quick and simple training



PDM



PDS

Part Number	Used with Tool Head	Description	Std. Pkg. Qty.
PDM	PAT1M, PAT1.5M	Stationary dispenser with electronic display. Online help menu through LCD display; multi-language; alarm sounds if error occurs. The system operates on 65 psig. (minimum) non-lubricated filtered air and 100 – 240 VAC/50 or 60 Hz – automatically adjusts within this range.	1
PDS	PAT2S		1

A. System Overview

B1. Cable Ties

B2. Cable Accessories

B3. Stainless Steel Ties

C1. Wiring Duct

C2. Surface Raceway

C3. Abrasion Protection

C4. Cable Management

D1. Terminals

D2. Power Connectors

D3. Grounding Connectors

E1. Labeling Systems

E2. Labels

E3. Pre-Printed & Write-On Markers

E4. Permanent Identification

E5. Lockout/Tagout & Safety Solutions

F. Index

A.
System
Overview

Transfer Hose



PHM3

Part Number	Used with Tool Head	Part Description	Length		Std. Pkg. Qty.
			Ft.	m	
PHM1	PAT1M, PAT1.5M	Transfers cable tie and signal from dispenser to tool head; electrical connectors designed for easy attachment provide a reliable, secure connection.	3.2	1	1
PHM2			6.5	2	1
PHM3			10.0	3	1
PHM4			13.1	4	1
PHS2	PAT2S		6.5	2	1
PHS3			10.0	3	1

B1.
Cable Ties

B2.
Cable
Accessories

B3.
Stainless
Steel Ties

C1.
Wiring
Duct

Dispenser Frame



Part Number	Used with Dispenser	Description	Std. Pkg. Qty.
PDSF	PDS (PAT2S)	Metal frame supports the PDS dispenser above the cable tie reel as ties are loaded into dispenser; can be used as a free-standing unit or permanently mounted to a bench or cart.	1

C2.
Surface
Raceway

C3.
Abrasion
Protection

C4.
Cable
Management

Optional System Accessories:

Filter/Regulator and Air Supply Hose

D1.
Terminals



PL283N1



PDH10-37

Part Number	Used with Dispenser	Description	Std. Pkg. Qty.
PL283N1	PDM, PDS	Regulates air flow to dispenser. Filter/regulator 25 micron (max.) element, 3/8" ports. Includes a male connector and a 3/8" port.	1
PDH10-37	PDM, PDS	Air hose from filter/regulator to dispenser; 10.0' (3m) – includes standard air fittings.	1

D2.
Power
Connectors

D3.
Grounding
Connectors

E1.
Labeling
Systems

Bench Mount



PATMBM

Part Number	Used with Tool Head	Description	Std. Pkg. Qty.
PATMBM	PAT1M, PAT1.5M	Allows hands-free operation for high volume usage. Includes bench mount fixture and foot pedal assembly.	1
PAT2SBM	PAT2S		1

E2.
Labels

E3.
Pre-Printed
& Write-On
Markers

E4.
Permanent
Identification



E5.
Lockout/
Tagout/
& Safety
Solutions

F.
Index

Data Interface Software and Ethernet Enabled Dispenser

PANDUIT exclusive Ethernet enabled dispenser and customized data interface software allow production personnel to monitor real-time data in a shop floor environment.

The Ethernet enabled dispenser provides a physical connection between the cable tie installation system and an Industrial Ethernet Network via an RJ45 connection and internal Ethernet card.

- Allows production and/or engineering personnel the capability to measure and track production performance such as job tracking, cycle counts, tool and dispenser serial numbers, and routine maintenance
- Provides the ability to send email notifications for specific system messages
- Data extraction and reporting capabilities on system performance through an exportable electronic log; helps identify operator training needs
- Ability to monitor alerts from remote desktop locations



Part Number	Used with Dispenser	Description	Std. Pkg. Qty.
PDM-DI	PDM	Ethernet enabled PDM dispenser and data interface software.	1
PDS-DI	PDS	Ethernet enabled PDS dispenser and data interface software.	1
PD-DIA	PDM/PDS	Data interface accessory for existing PDM, PDS dispensers; software and network interface card.	1

A.
System
Overview

B1.
Cable Ties

B2.
Cable
Accessories

B3.
Stainless
Steel Ties

C1.
Wiring
Duct

C2.
Surface
Raceway

C3.
Abrasion
Protection

C4.
Cable
Management

D1.
Terminals

D2.
Power
Connectors

D3.
Grounding
Connectors

E1.
Labeling
Systems

E2.
Labels

E3.
Pre-Printed
& Write-On
Markers

E4.
Permanent
Identification

E5.
Lockout/
Tagout
& Safety
Solutions

F.
Index

A.
System
Overview

BT-XMR Reel-Fed Cable Ties

- Continuously molded cable ties (5,000 ties/reel) provide continuous feeding for high productivity and reduced downtime due to fewer reel changes
- Reel-fed cable ties with exclusive stainless steel locking barb and 30 lbs. minimum loop tensile strength permit higher tension for demanding applications
- Metal locking barb and tie body design provide greater bundle tightness, reducing both rotational and lateral movement of the tie

B1.
Cable Ties

B2.
Cable
Accessories

B3.
Stainless
Steel Ties



BT_XMR

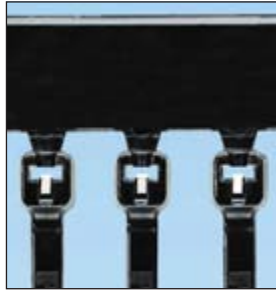

BT_XMR (0, 30)

C1.
Wiring
Duct

C2.
Surface
Raceway

C3.
Abrasion
Protection

C4.
Cable
Management



Part Number	Tie Style	Material	Color	Max. Bundle Dia.		Length		Width		Min. Loop Tensile Str.	
				In.	mm	In.	mm	In.	mm	Lbs.	N

Reel-Fed Cable Ties for PAT1M System

BT1M-XMR	Barbed	Nylon 6.6	Natural	.82	21	4.0	102	.100	2.5	30	133
BT1M-XMR0	Barbed	Weather Resistant Nylon 6.6	Black	.82	21	4.0	102	.100	2.5	30	133
BT1M-XMR30	Barbed	Heat Stabilized Nylon 6.6	Black	.82	21	4.0	102	.100	2.5	30	133

Reel-Fed Cable Ties for PAT1.5M System

BT1.5M-XMR	Barbed	Nylon 6.6	Natural	1.31	33	5.6	142	.100	2.5	30	133
BT1.5M-XMR0	Barbed	Weather Resistant Nylon 6.6	Black	1.31	33	5.6	142	.100	2.5	30	133
BT1.5M-XMR30	Barbed	Heat Stabilized Nylon 6.6	Black	1.31	33	5.6	142	.100	2.5	30	133
BT1.5M-XMR69*	Barbed	Flame Retardant Nylon 6.6	Natural (Ivory)	1.31	33	5.6	142	.100	2.5	18	80

*Flammability rating of UL 94V-0
Note: UL Recognized, UL Listed, and CSA Certified except 69 material.

E1.
Labeling
Systems

E2.
Labels

E3.
Pre-Printed
& Write-On
Markers

E4.
Permanent
Identification

E5.
Lockout/
Tagout/
& Safety
Solutions

F.
Index

UL US **CS** **SR** US **PLT-XMR Reel-Fed Cable Ties**

- Continuously molded cable ties (5,000 ties/reel) provide continuous feeding for high productivity and reduced downtime due to fewer reel changes
- All-nylon, one-piece locking ties with 18 lbs. minimum loop tensile strength in miniature cross section
- Available in a variety of colors and materials

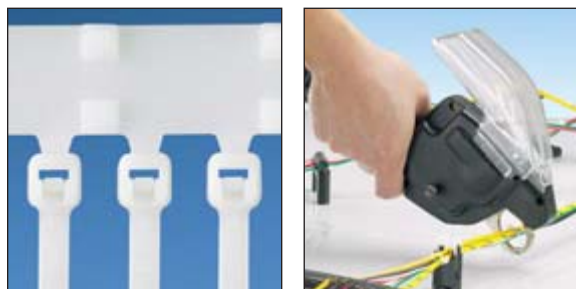

Part Number	Tie Style	Material	Color	Max. Bundle Dia.		Length		Width		Min. Loop Tensile Str.	
				In.	mm	In.	mm	In.	mm	Lbs.	N
Reel-Fed Cable Ties for PAT1M System											
PLT1M-XMR	All-Nylon	Nylon 6.6	Natural	.82	21	4.0	102	.100	2.5	18	80
PLT1M-XMR0	All-Nylon	Weather Resistant Nylon 6.6	Black	.82	21	4.0	102	.100	2.5	18	80
PLT1M-XMR00*	All-Nylon	Weather Resistant Nylon 6.6	Black	.82	21	4.0	102	.100	2.5	18	80
PLT1M-XMR1	All-Nylon	Nylon 6.6	Brown	.82	21	4.0	102	.100	2.5	18	80
PLT1M-XMR2	All-Nylon	Nylon 6.6	Red	.82	21	4.0	102	.100	2.5	18	80
PLT1M-XMR3	All-Nylon	Nylon 6.6	Orange	.82	21	4.0	102	.100	2.5	18	80
PLT1M-XMR4Y	All-Nylon	Nylon 6.6	Yellow	.82	21	4.0	102	.100	2.5	18	80
PLT1M-XMR5	All-Nylon	Nylon 6.6	Green	.82	21	4.0	102	.100	2.5	18	80
PLT1M-XMR6	All-Nylon	Nylon 6.6	Blue	.82	21	4.0	102	.100	2.5	18	80
PLT1M-XMR7	All-Nylon	Nylon 6.6	Purple	.82	21	4.0	102	.100	2.5	18	80
PLT1M-XMR8	All-Nylon	Nylon 6.6	Gray	.82	21	4.0	102	.100	2.5	18	80
PLT1M-XMR10	All-Nylon	Nylon 6.6	White	.82	21	4.0	102	.100	2.5	18	80
PLT1M-XMR30	All-Nylon	Heat Stabilized Nylon 6.6	Black	.82	21	4.0	102	.100	2.5	18	80

Reel-Fed Cable Ties for PAT1.5M System											
PLT1.5M-XMR	All-Nylon	Nylon 6.6	Natural	1.31	33	5.6	142	.100	2.5	18	80
PLT1.5M-XMR0	All-Nylon	Weather Resistant Nylon 6.6	Black	1.31	33	5.6	142	.100	2.5	18	80
PLT1.5M-XMR00*	All-Nylon	Weather Resistant Nylon 6.6	Black	1.31	33	5.6	142	.100	2.5	18	80
PLT1.5M-XMR30	All-Nylon	Heat Stabilized Nylon 6.6	Black	1.31	33	5.6	142	.100	2.5	18	80

*Military grade weather resistant material.

Note: PLT_XMR cable ties (natural, 00, and colors) are Class 2 Mil. Spec. per SAE-AS23190A and SAE-AS33671.

A. System Overview

B1. Cable Ties

B2. Cable Accessories

B3. Stainless Steel Ties

C1. Wiring Duct

C2. Surface Raceway

C3. Abrasion Protection

C4. Cable Management

D1. Terminals

D2. Power Connectors

D3. Grounding Connectors

E1. Labeling Systems

E2. Labels

E3. Pre-Printed & Write-On Markers

E4. Permanent Identification

E5. Lockout/Tagout & Safety Solutions

F. Index

A. System Overview

PLT-VMR Reel-Fed Cable Ties

- Continuously molded cable ties (2,500 ties/reel) provide continuous feeding for high productivity and reduced downtime due to fewer reel changes
- All-nylon, one-piece locking ties with 50 lbs. minimum loop tensile strength in standard cross section for larger bundles up to 2" diameter

B1. Cable Ties

B2. Cable Accessories

B3. Stainless Steel Ties



C1. Wiring Duct

C2. Surface Raceway

Part Number	Tie Style	Material	Color	Max. Bundle Dia.		Length		Width		Min. Loop Tensile Str.	
				In.	mm	In.	mm	In.	mm	Lbs.	N
Reel-Fed Cable Ties for PAT2S System											
PLT2S-VMR	All-Nylon	Nylon 6.6	Natural	2.00	51	8.1	206	.190	4.8	50	222
PLT2S-VMR0	All-Nylon	Weather Resistant Nylon 6.6	Black	2.00	51	8.1	206	.190	4.8	50	222
PLT2S-VMR30	All-Nylon	Heat Stabilized Nylon 6.6	Black	2.00	51	8.1	206	.190	4.8	50	222

Note: PLT_VMR Nylon 6.6 cable ties are Class 2 Mil. Spec. per SAE-AS23190A and SAE-AS33671.

D1. Terminals

D2. Power Connectors

Tie Harness Mount for Single Cable Tie – Nylon and Heat Stabilized Nylon 6.6

- Secured with only one cable tie
- Cable ties can be installed by hand or with *PANDUIT* automatic cable tie tools
- Wing design provides added stability
- Natural nylon material for indoor use
- Heat stabilized material for high temperature applications – indoor use

D3. Grounding Connectors

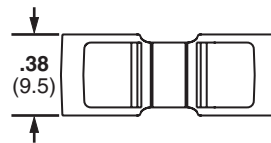
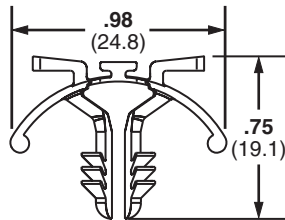

E1. Labeling Systems

E2. Labels

Part Number	Used with Cable Ties*	Maximum Panel Thickness		Panel Hole Diameter		Color	Mounting Method	Std. Pkg. Qty.	Std. Ctn. Qty.
		In.	mm	In.	mm				
Nylon 6.6									
THM1SC-C	M, I, S	.135	3.4	.250	6.4	Natural	Tree barb	100	1000
Heat Stabilized Nylon 6.6									
THM1SC-C30	M, I, S	.135	3.4	.250	6.4	Black	Tree barb	100	1000

*Cable tie cross section sizes: M = Miniature, I = Intermediate, S = Standard.

F. Index

Tie Harness Mounts – Nylon and Heat Stabilized Nylon 6.6

- Designed to be attached to the wire harness during assembly
- Cable ties can be installed by hand or with *PANDUIT* automatic cable tie tools on page B1.115
- Used with harness board standoff posts, see page B2.51
- Available with or without corrugated tubing location tab
- Natural nylon material for indoor use
- Heat stabilized nylon material (30) for high temperature applications – indoor use

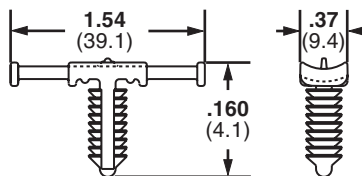

Part Number	Used with Cable Ties*	Maximum Panel Thickness		Panel Hole Diameter		Material	Color	Mounting Method	Std. Pkg. Qty.	Std. Ctn. Qty.
		In.	mm	In.	mm					
FOR CORRUGATED TUBING – A location tab on the mount shelf aligns with the corrugated tubing grooves to ensure proper mount location during assembly										
THMSP20-C	M, I, S	.160	4.1	.244 – .283	6.2 – 7.2	Nylon 6.6	Natural	Push barb	100	1000
THMSP20-C30	M, I, S	.160	4.1	.244 – .283	6.2 – 7.2	Heat Stabilized Nylon 6.6	Black	Push barb	100	1000
THMSP25-C	M, I, S	.230	5.8	.244 – .283	6.2 – 7.2	Nylon 6.6	Natural	Push barb	100	1000
THMSP25-C30	M, I, S	.230	5.8	.244 – .283	6.2 – 7.2	Heat Stabilized Nylon 6.6	Black	Push barb	100	1000
FOR DISCRETE WIRING – No location tab										
THMSP20F-C	M, I, S	.160	4.1	.244 – .283	6.2 – 7.2	Nylon 6.6	Natural	Push barb	100	1000
THMSP20F-C30	M, I, S	.160	4.1	.244 – .283	6.2 – 7.2	Heat Stabilized Nylon 6.6	Black	Push barb	100	1000
THMSP25F-C	M, I, S	.230	5.8	.244 – .283	6.2 – 7.2	Nylon 6.6	Natural	Push barb	100	1000
THMSP25F-C30	M, I, S	.230	5.8	.244 – .283	6.2 – 7.2	Heat Stabilized Nylon 6.6	Black	Push barb	100	1000

*Cable tie cross section sizes: M = Miniature, I = Intermediate, S = Standard.

A.
System
Overview

B1.
Cable Ties

B2.
Cable
Accessories

B3.
Stainless
Steel Ties

C1.
Wiring
Duct

C2.
Surface
Raceway

C3.
Abrasion
Protection

C4.
Cable
Management

D1.
Terminals

D2.
Power
Connectors

D3.
Grounding
Connectors

E1.
Labeling
Systems

E2.
Labels

E3.
Pre-Printed
& Write-On
Markers

E4.
Permanent
Identification

E5.
Lockout/
Tagout
& Safety
Solutions

F.
Index

A.
System
Overview

B1.
Cable Ties

B2.
Cable
Accessories

B3.
Stainless
Steel Ties

C1.
Wiring
Duct

C2.
Surface
Raceway

C3.
Abrasion
Protection

C4.
Cable
Management

D1.
Terminals

D2.
Power
Connectors

D3.
Grounding
Connectors

E1.
Labeling
Systems

E2.
Labels

E3.
Pre-Printed
& Write-On
Markers

E4.
Permanent
Identification

E5.
Lockout/
Tagout/
& Safety
Solutions

F.
Index

NOTES

CABLE ACCESSORIES



PANDUIT provides a comprehensive offering of cable accessories. These accessories are engineered to speed installation and lower installed costs for routing and managing cable. *PANDUIT* cable accessories are designed and manufactured to meet applicable quality standards including International, UL, Military, ISO and Aerospace.



- Largest selection of mounts, clips, and clamps for cable management
- *PANDUIT* cable ties and accessories can be used in a variety of applications and environments, providing the optimal cable management solution
- Installation methods include adhesive backed, user applied adhesive, screws, rivets or push barb



PANDUIT mounts, clips, and clamps are manufactured in an environment committed to design innovation, high quality, and knowledgeable service to our customers. Adhesive backed mounts provide a strong adhesive bond for long-term reliability. Cable clips offer a one-piece solution to save time and reduce inventory. Harness board accessories speed the routing and forming of cable bundles in the fabrication of a harness. They hold bundles at a uniform height above the board and are ideal for use with *PANDUIT* manual and automatic cable tie tooling.

A.
System
Overview

B1.
Cable Ties

B2.
Cable
Accessories

B3.
Stainless
Steel Ties

C1.
Wiring
Duct

C2.
Surface
Raceway

C3.
Abrasion
Protection

C4.
Cable
Management

D1.
Terminals

D2.
Power
Connectors

D3.
Grounding
Connectors

E1.
Labeling
Systems

E2.
Labels

E3.
Pre-Printed
& Write-On
Markers

E4.
Permanent
Identification

E5.
Lockout/
Tagout/
& Safety
Solutions

F.
Index

A. System Overview

4-Way Adhesive Backed Cable Tie Mounts

B1. Cable Ties

- Allow cable tie entry from all four sides
- Available in multiple sizes to match application load requirements
- Produced 2-up or 4-up for fast and easy liner removal to speed installation

B2. Cable Accessories

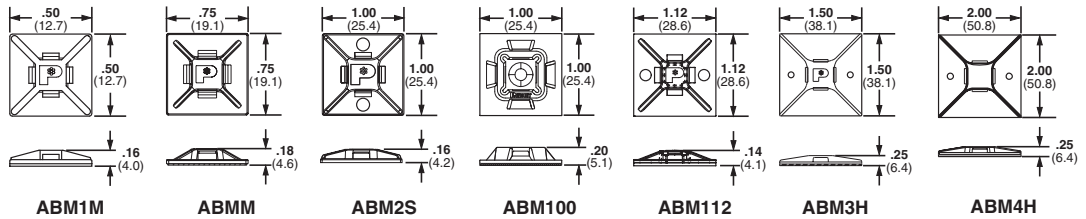

C1. Wiring Duct

C2. Surface Raceway

C3. Abrasion Protection

C4. Cable Management

D1. Terminals

D2. Power Connectors

D3. Grounding Connectors

E1. Labeling Systems

E2. Labels

E3. Pre-Printed & Write-On Markers

E4. Permanent Identification

E5. Lockout/Tagout & Safety Solutions

F. Index

Part Number	Used with Cable Ties‡	Material	Color	Environment	Mounting Method*	Max. Static Load		Std. Pkg. Qty.	Std. Ctn. Qty.
						Lbs.	g		
4-Way Mounts with Adhesive									
ABM1M-A-C	M	Nylon 6.6	White	Indoors	Rubber	.13	59.0	100	500
ABM1M-AT-C		Nylon 6.6	White	Indoors/High Temp	Acrylic	.13	59.0	100	500
ABMM-A-C	M, I	ABS	White	Indoors	Rubber	.30	136.0	100	500
ABMM-AT-C		ABS	White	Indoors/High Temp	Acrylic	.30	136.0	100	500
ABMM-AT-C0		Weather Resistant ABS	Black	Outdoors/High Temp	Acrylic	.30	136.0	100	500
ABM2S-A-C		ABS	White	Indoors	Rubber	.50	227.0	100	500
ABM2S-A-C14	M, I, S	ABS	Gray	Indoors	Rubber	.50	227.0	100	500
ABM2S-A-C15		ABS	Ivory	Indoors	Rubber	.50	227.0	100	500
ABM2S-AT-C		ABS	White	Indoors/High Temp	Acrylic	.50	227.0	100	500
ABM2S-AT-C0		Weather Resistant ABS	Black	Outdoors/High Temp	Acrylic	.50	227.0	100	500
ABM100-A-C		Nylon 6.6	White	Indoors	Rubber	.50	227.0	100	1000
ABM100-A-C15		Nylon 6.6	Ivory	Indoors	Rubber	.50	227.0	100	1000
ABM100-AT-C		Nylon 6.6	White	Indoors/High Temp	Acrylic	.50	227.0	100	1000
ABM100-AT-C0		Weather Resistant Nylon 6.6	Black	Outdoors/High Temp	Acrylic	.50	227.0	100	1000
ABM112-A-C		Nylon 6.6	White	Indoors	Rubber	.63	286.0	100	500
ABM112-AT-C		Nylon 6.6	White	Indoors/High Temp	Acrylic	.63	286.0	100	1000
ABM112-AT-C0	Weather Resistant Nylon 6.6	Black	Outdoors/High Temp	Acrylic	.63	286.0	100	1000	
ABM3H-A-L	M, I, S, HS, LH, H, HLM	Nylon 6.6	White	Indoors	Rubber	1.12	513.0	50	500
ABM3H-AT-L		Nylon 6.6	White	Indoors/High Temp	Acrylic	1.12	513.0	50	500
ABM4H-A-L		Nylon 6.6	White	Indoors	Rubber	2.00	907.0	50	500
ABM4H-AT-L		Nylon 6.6	White	Indoors/High Temp	Acrylic	2.00	907.0	50	500

‡Cable tie cross section sizes: M = Miniature, I = Intermediate, S = Standard, HS = Heavy-Standard, LH = Light-Heavy, H = Heavy, and HLM = Miniature TAK-TY® Hook & Loop Ties.

*For proper selection of adhesives see page B2.52

4-Way Adhesive Backed Cable Tie Mounts (continued)

Part Number	Used with Cable Ties‡	Material	Color	Environment	Mounting Method*	Max. Static Load		Std. Pkg. Qty.	Std. Ctn. Qty.	
						Lbs.	g			
4-Way Mounts without Adhesive										
ABMM-D	M, I	ABS	White	Indoors	User Supplied Adhesive	—	—	500	5000	
ABM2S-S6-D	M, I, S	ABS	White	Indoors	User supplied adhesive and/or two #6 (M3) Screws	—	—	500	5000	
ABM100-S6-C		Nylon 6.6	White	Indoors		—	—	100	1000	
ABM100-S6-C69		Flame Retardant Nylon 6.6	Natural	Indoors	User Supplied Adhesive and/or #6 (M3) Screw	—	—	100	1000	
ABM112-S6-C		Nylon 6.6	White	Indoors	User Supplied Adhesive and/or Two #6 (M3) Screws	—	—	100	1000	
ABM112-S6-C69		Flame Retardant Nylon 6.6	Natural	Indoors		—	—	100	500	
ABM3H-S6-T		M, I, S, HS, LH, H, HLM	Nylon 6.6	White	Indoors	User Supplied Adhesive and/or Two #6 (M3) Screws	—	—	200	2000
ABM4H-S6-T			Nylon 6.6	White	Indoors		—	—	200	1000

‡Cable tie cross section sizes: M = Miniature, I = Intermediate, S = Standard, HS = Heavy-Standard, LH = Light-Heavy, H = Heavy, and HLM = Miniature TAK-TY® Hook & Loop Ties.

*For proper selection of adhesives see page B2.52

A.
System
Overview

B1.
Cable Ties

B2.
Cable
Accessories

B3.
Stainless
Steel Ties

C1.
Wiring
Duct

C2.
Surface
Raceway

C3.
Abrasion
Protection

C4.
Cable
Management

D1.
Terminals

D2.
Power
Connectors

D3.
Grounding
Connectors

E1.
Labeling
Systems

E2.
Labels

E3.
Pre-Printed
& Write-On
Markers

E4.
Permanent
Identification

E5.
Lockout/
Tagout/
& Safety
Solutions

F.
Index

A.
System
Overview

ABMQ Multiple Bridge Mounts

B1.
Cable Ties

B2.
Cable
Accessories

B3.
Stainless
Steel Ties

C1.
Wiring
Duct

C2.
Surface
Raceway

C3.
Abrasion
Protection

C4.
Cable
Management

D1.
Terminals

D2.
Power
Connectors

D3.
Grounding
Connectors

E1.
Labeling
Systems

E2.
Labels

E3.
Pre-Printed
& Write-On
Markers

E4.
Permanent
Identification

E5.
Lockout/
Tagout/
& Safety
Solutions

F.
Index

- Multiple cable tie bridges on one mount speeds installation of cable bundles by reducing the number of mounts applied
- Dovetail connection system provides alignment and a joining method to expand routing capabilities
- V-groove allows for easy separation into two mounts with two bridges each for separate applications

- 4-way cable tie bridges allow cable bundles to be secured perpendicular to the mount for even spacing or inline to secure a bundle in multiple places
- Large adhesive surface area provides long-term reliability and keeps product in place despite heavy load or high stress

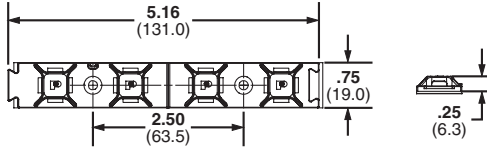

Part Number	Used with Cable Ties‡	Material	Color	Environment	Mounting Method	Max. Static Load		Std. Pkg. Qty.	Std. Ctn. Qty.
						Lbs.	g		
ABMQ Mounts with Adhesive									
ABMQS-A-Q	M, I, S	ABS	White	Indoors	Rubber	1.85	838.0	25	250
ABMQS-A-Q20		ABS	Black	Indoors	Rubber			25	250
ABMQS-AT-Q		ABS	White	Indoors/High Temp	Acrylic			25	250
ABMQS-AT-Q0		Weather Resistant ABS	Black	Outdoors/High Temp	Acrylic			25	250
ABMQ Mounts without Adhesive									
ABMQS-S6-C0	M, I, S	Weather Resistant ABS	Black	Outdoors/High Temp	User Supplied Adhesive and/or two #6 M3 Screws	—	—	100	1000
ABMQS-S6-C		ABS	White	Indoors/High Temp				100	1000

‡Cable tie cross section sizes: M = Miniature, I = Intermediate, and S = Standard.

® SUPER-GRIP® Adhesive Back Mounts

- Low profile design keeps bundle close to mounting surface
- Small overall size allows use where space is limited

- For use with SUPER-GRIP® Cable Ties found on page B1.38

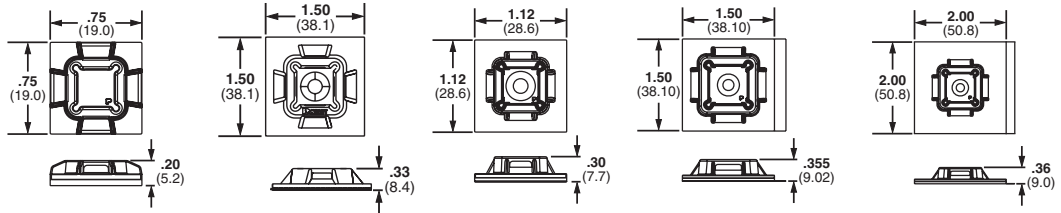

Part Number	Used with Cable Ties‡	Material	Color	Environment	Mounting Method*	Max. Static Load		Std. Pkg. Qty.	Std. Ctn. Qty.
						Lbs.	g		
Adhesive Backed Mounts									
SGABM20-A-C	SGM, SGI	Nylon 6.6	White	Indoor Use	Rubber	.28	127	100	500
SGABM20-AT-C0		Weather Resistant Nylon 6.6	Black	Outdoors/High Temp	Acrylic	.28	127	100	500
SGABM25-A-C	SGM, SGI, SGS	Nylon 6.6	White	Indoor Use	Rubber	.50	227	100	1000
SGABM25-AT-C0		Weather Resistant Nylon 6.6	Black	Outdoors/High Temp	Acrylic	.50	227	100	1000
SGABM30-A-C		Nylon 6.6	White	Indoor Use	Rubber	.63	286	100	500
SGABM30-AT-C0		Weather Resistant Nylon 6.6	Black	Outdoors/High Temp	Acrylic	.63	286	100	500
SGABM40-A-L	SGM, SGI, SGS, SGLH, SGH	Nylon 6.6	White	Indoor Use	Rubber	1.13	51.3	50	500
SGABM40-AT-L0		Weather Resistant Nylon 6.6	Black	Outdoors/High Temp	Acrylic	1.13	51.3	50	500
SGABM50-A-L		Nylon 6.6	White	Indoor Use	Rubber	2.00	907	50	500
SGABM50-AT-L0		Weather Resistant Nylon 6.6	Black	Outdoors/High Temp	Acrylic	2.00	907	50	500
Adhesive Backed Mounts									
SGABM25-S6-C	SGM, SGI, SGS	Nylon 6.6	White	Indoors	#6 (M3) Screw	—	—	100	1000
SGABM25-S6-C0		Weather Resistant Nylon 6.6	Black	Outdoors	User Supplied Adhesive and/or #6 (M3) Screw	—	—	100	1000

‡Cable tie cross section sizes: SGM = SUPER-GRIP® Miniature, SGI = SUPER-GRIP® Intermediate, SGS = SUPER-GRIP® Standard, SGLH = SUPER-GRIP® Light-Heavy, and SGH = SUPER-GRIP® Heavy.

*For proper selection of adhesive see page B2.52

A.
System
Overview

B1.
Cable Ties

B2.
Cable
Accessories

B3.
Stainless
Steel Ties

C1.
Wiring
Duct

C2.
Surface
Raceway

C3.
Abrasion
Protection

C4.
Cable
Management

D1.
Terminals

D2.
Power
Connectors

D3.
Grounding
Connectors

E1.
Labeling
Systems

E2.
Labels

E3.
Pre-Printed
& Write-On
Markers

E4.
Permanent
Identification

E5.
Lockout/
Tagout
& Safety
Solutions

F.
Index

A. System Overview

Combination Adhesive Mount/Cable Ties

B1. Cable Ties

- Adhesive mount and cable tie molded as one-piece helps reduce inventory costs
- Available with locking or releasable tie
- For indoor use only
- Material: Nylon 6.6

B2. Cable Accessories



B3. Stainless Steel Ties

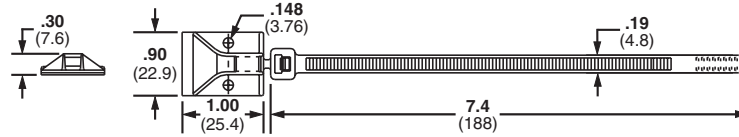

C1. Wiring Duct

C2. Surface Raceway

C3. Abrasion Protection

C4. Cable Management

D1. Terminals

D2. Power Connectors

D3. Grounding Connectors

E1. Labeling Systems

E2. Labels

E3. Pre-Printed & Write-On Markers

E4. Permanent Identification

E5. Lockout/Tagout & Safety Solutions

F. Index

Part Number	Tool	Color	Adhesive Type	Max. Static Load		Std. Pkg. Qty.	Std. Ctn. Qty.
				Lbs.	g		
Locking Cable Tie							
PLA2S-A-Q	GTS, GTSL, GS2B, GS4H, PTS, PTH, PPTS, STS2, STH2	White	Rubber	.45	204.0	25	250
Releasable Cable Tie							
PRA2S-A-Q	Hand installed only	White	Rubber	.45	204.0	25	250

Snap-In Cable Tie Mounts – Mechanically Applied

- For use with *PANDUIT* Standard cross section cable ties including PLT1S, PLT1.5S, PLT2S, PRT1.5S and PRT2S
- Quickly route wire and cable where mounting holes cannot be drilled
- Integral retaining notch holds cable tie head in place below bundle
- For indoor use only
- Eliminates protruding tie head and facilitates one hand tie threading
- Material: ABS

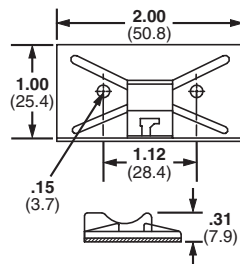

Part Number	Used with Cable Ties‡	Color	Mounting Method	Max. Static Load		Std. Pkg. Qty.	Std. Ctn. Qty.
				Lbs.	g		
Adhesive Backed							
SMS-A-C	S	White	Rubber	1.0	454.0	100	500
SMS-A-C14		Gray	Rubber	1.0	454.0	100	500
SMS-A-C15		Ivory	Rubber	1.0	454.0	100	500
Screw Mount							
SMS-S6-D	S	White	User Supplied Adhesive and/or Two #6 M3 Screws	—	—	500	5000

‡Cable tie cross section size: S = Standard.

Epoxy Applied Mounts

- Provide a fast, strong, economical method to secure wire/cable to most surfaces
- Eliminate the need to drill holes

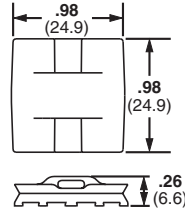

Part Number	Used with Cable Ties‡	Material	Color	Environment	Mounting Method	Max. Static Load		Std. Pkg. Qty.	Std. Ctn. Qty.
						Lbs.	g		
EMS-A-C	M, I, S	Nylon 6.6	Natural	Indoors	EMA epoxy	10.0	4540	100	1000
EMS-A-C0		Weather Resistant Nylon 6.6	Black	Outdoors					

‡Cable tie cross section sizes: M = Miniature, I = Intermediate, and S = Standard.

Epoxy Applied Swivel Mount

- Swivels 360° to assure proper orientation with harness
- For indoor use only
- Four inspection holes to check adhesive coverage

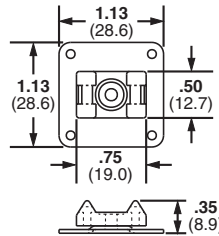

Part Number	Used with Cable Ties‡	Mounting Method	Max. Static Load		Std. Pkg. Qty.	Std. Ctn. Qty.
			Lbs.	g		
ASMS-A-X	M, I, S, SGM, SGI	EMA epoxy	10.0	4540	10	100

‡Cable tie cross section sizes: M = Miniature, I = Intermediate, S = Standard, SGM = SUPER-GRIP® Miniature, and SGI = SUPER-GRIP® Intermediate.

A.
System
Overview

B1.
Cable Ties

B2.
Cable
Accessories

B3.
Stainless
Steel Ties

C1.
Wiring
Duct

C2.
Surface
Raceway

C3.
Abrasion
Protection

C4.
Cable
Management

D1.
Terminals

D2.
Power
Connectors

D3.
Grounding
Connectors

E1.
Labeling
Systems

E2.
Labels

E3.
Pre-Printed
& Write-On
Markers

E4.
Permanent
Identification

E5.
Lockout/
Tagout
& Safety
Solutions

F.
Index

A.
System
Overview

Epoxy Applied Cable Tie Mount Kits

B1.
Cable Ties

- EMA Epoxy supplied in convenient two-compartment mixer cup with a mixer stick for each cup
- Each cup contains adhesive for three EMS or ASMS mounts
- Epoxy hardens in approximately five minutes
- After full 24 hour cure time, bonding strength will exceed 50 lbs. on a clean, grease-free surface
- Not recommended for use on polyethylene and polypropylene surfaces

B2.
Cable
Accessories

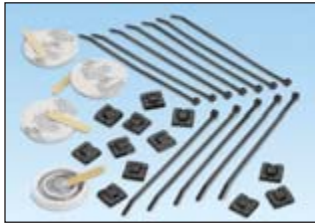

B3.
Stainless
Steel Ties

Part Number	Used with Cable Ties‡	Environment	Epoxy Cups	Mixer Sticks	EMS Mounts	Cable Ties	Std. Pkg. Qty.	Std. Ctn. Qty.
Epoxy Adhesive Only								
EMA-X	—	Indoors/Outdoors	10	10	—	—	10	—
Epoxy Mounting Kit with EMS Mounts								
EMSK3-1-X0	M, I, S	Indoors/Outdoors	1	1	3	—	10	—
Epoxy Mounting Kit with EMS Mounts and Cable Ties								
EMSK3-1-3-0	M, I, S	Indoors/Outdoors	1	1	3	3	1	10
EMSK12-4-12-X0		Indoors/Outdoors	4	4	12	12	10	10

‡Cable tie cross section sizes: M = Miniature, I = Intermediate, and S = Standard.

C1.
Wiring
Duct

C2.
Surface
Raceway

C3.
Abrasion
Protection

C4.
Cable
Management

D1.
Terminals

D2.
Power
Connectors

D3.
Grounding
Connectors

E1.
Labeling
Systems

E2.
Labels

E3.
Pre-Printed
& Write-On
Markers

E4.
Permanent
Identification

E5.
Lockout/
Tagout/
& Safety
Solutions

F.
Index

Cable Tie Mounts

- Unique cradle design provides maximum stability for the cable bundle
- Low profile design keeps bundle close to mounting surface
- For indoor use only
- Material: Nylon 6.6

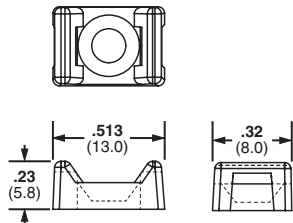

TM1

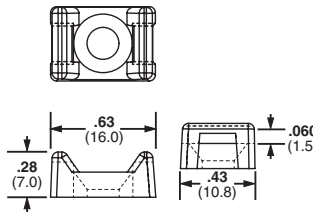

TM2

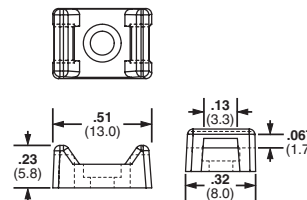

TM3



Part Number	Used with Cable Ties*	Counterbore Diameter		Mounting Method	Std. Pkg. Qty.	Std. Ctn. Qty.
		In.	mm			
TM1S4-M69	M	.23	5.7	#4 (M2.5) screw	1000	5000
TM1S6-M69		.28	7.0	#6 (M3) screw	1000	5000
TM2S6-M69	M, I, S	.29	7.1	#6 (M3) screw	1000	5000
TM2S8-M69		.33	8.4	#8 (M4) screw	1000	5000
TM3S8-C69	M, I, S, LH	.32	8.1	#8 (M4) screw	100	500
TM3S10-M69		.38	9.7	#10 (M5) screw	1000	5000

‡Cable tie cross section sizes: M = Miniature, I = Intermediate, S = Standard, and LH = Light-Heavy.

Additional tie mounts available in specified materials. All are available as standard PANDUIT parts.

Heat Stabilized Nylon	Flame Retardant Nylon	Weather Resistant Nylon	Weather Resistant Polypropylene	TEFZEL [®]
TM1S4-M30	TM1S4-M69	TM1S6-M0	TM2S8-C100	TM2S8-C76
TM1S6-M30	TM1S6-M69	TM2R6-M0	TM3S8-C100	TM3S8-C76
TM2R6-M30	TM2S6-M69	TM2S6-M0	TM3S8-M100	TM3S10-C76
TM2S6-M30	TM2S8-M69	TM2S8-M0		
TM2S8-M30	TM3S8-C69	TM3R6-M0		
TM3S8-M30	TM3S8-M69	TM3S10-M0		
TM3S10-M30	TM3S10-M69	TM3S25-M0		
TM3S25-M30				

▪TEFZEL is a registered trademark of E.I. du Pont de Nemours and Company.

A.
System
Overview

B1.
Cable Ties

B2.
Cable
Accessories

B3.
Stainless
Steel Ties

C1.
Wiring
Duct

C2.
Surface
Raceway

C3.
Abrasion
Protection

C4.
Cable
Management

D1.
Terminals

D2.
Power
Connectors

D3.
Grounding
Connectors

E1.
Labeling
Systems

E2.
Labels

E3.
Pre-Printed
& Write-On
Markers

E4.
Permanent
Identification

E5.
Lockout/
Tagout
& Safety
Solutions

F.
Index

A. System Overview

TAK-TY® Hook & Loop Cable Tie Mounts

- For use with TAK-TY® Hook & Loop Cable Ties, see page B1.87
- Unique cradle design provides maximum stability for cable bundle
- For indoor use only
- Dimensions: 1.10L x 1.10W x .34H (27.9mm x 27.9mm x 8.6mm)

B1. Cable Ties

B2. Cable Accessories



B3. Stainless Steel Ties

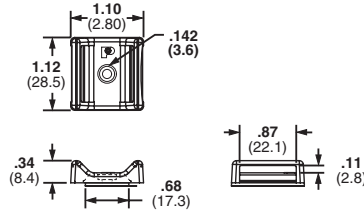

C1. Wiring Duct

C2. Surface Raceway

C3. Abrasion Protection

C4. Cable Management

Part Number	Used with Cable Ties‡	Material	Color	Max. Static Load		Mounting Method*	Std. Pkg. Qty.	Std. Ctn. Qty.
				Lbs.	g			
ABMT-A-C	HLT	Nylon 6.6	Natural	.38	174	Rubber	100	1000
ABMT-A-C20			Black				100	1000
ABMT-S6-C			Natural	—	—	#6 (M3) Screw	100	1000
ABMT-S6-C20		Black	100				1000	
ABMT-S6-C60		Black	100				1000	
ABMT-S6-C69	Flame Retardant Nylon 6.6	Natural	100	1000				

‡Cable tie cross section sizes: HLT/HLS = TAK-TY® Hook & Loop Ties.
*For proper selection of adhesives see page B2.52

D1. Terminals

Extra-Heavy Cable Tie Mounts

- Unique cradle design provides maximum stability for cable bundle
- Route and support large diameter and heavy cable bundles

D2. Power Connectors

D3. Grounding Connectors



E1. Labeling Systems

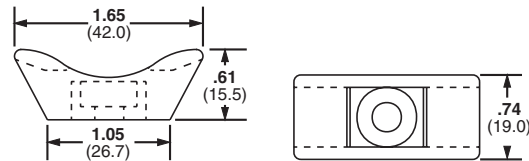

E2. Labels

E3. Pre-Printed & Write-On Markers

E4. Permanent Identification

E5. Lockout/Tagout & Safety Solutions

F. Index

Part Number	Used with Cable Ties‡	Material	Color	Environment	Mounting Method	Std. Pkg. Qty.	Std. Ctn. Qty.
TMEH-S8-Q0	M, I, S, HS, LH, H, EH, HLM	Weather Resistant Nylon 6.6	Black	Outdoors	#8 (M4) Screw	25	250
TMEH-S10-Q0					#10 (M5) Screw	25	250
TMEH-S25-Q0					1/4 (M6) Screw	25	250
TMEH-S10-C100		Weather Resistant Polypropylene	Green	Indoors	#10 (M5) Screw	100	500
TMEH-S10-C109		Polypropylene			#10 (M5) Screw	100	500

‡Cable tie cross section sizes: M = Miniature, I = Intermediate, S = Standard, HS = Heavy-Standard, LH = Light-Heavy, H = Heavy, EH = Extra-Heavy and HLM = Miniature TAK-TY® Hook & Loop Ties.

TM Tie Mounts – Applied with User Supplied Adhesives

- Solid flat bottom surface provides maximum holding area
- For indoor use only
- Material: Nylon 6.6



Part Number	Used with Cable Ties‡	Color	Mounting Method	Std. Pkg. Qty.	Std. Ctn. Qty.
TM1A-C	M	Natural	User Supplied Adhesive	100	1000
TM2A-C	M, I, S			100	500
TM3A-C	M, I, S, HS, LH			100	500

‡Cable tie cross section sizes: M = Miniature, I = Intermediate, S = Standard, HS = Heavy Standard and LH = Light-Heavy.

AM Low Profile Tie Mounts – User Supplied Adhesive Mounts

- Low profile design keeps bundle close to mounting surface
- For indoor use only
- Material: Nylon 6.6

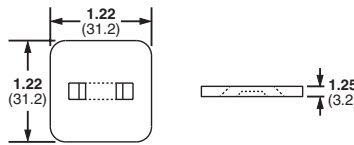

Part Number	Used with Cable Ties‡	Color	Mounting Method	Std. Pkg. Qty.	Std. Ctn. Qty.
AM2-C	M, I, S	Natural	User Supplied Adhesive	100	500

‡Cable tie cross section sizes: M = Miniature, I = Intermediate, and S = Standard.

Swivel Mounts

- The two mounts are securely fastened together with a connecting rivet that allows both mounts to rotate
- Can join bundles of cable, tubing, or hoses that may need to move or are not parallel
- Separates bundles to avoid abrasion
- Material: Weather Resistant Nylon 6.6

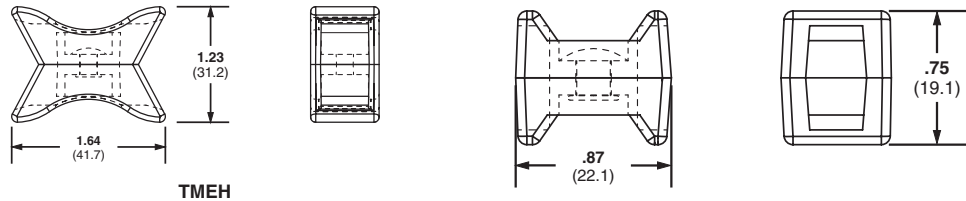

Part Number	Used with Cable Ties‡	Pull Apart Force		Color	Environment	Std. Pkg. Qty.	Std. Ctn. Qty.
		Lbs.	g				
TM3-X2-C0Y	M, I, S, HS, LH	120	54,431	Black	Indoors/Outdoors	100	1000
TMEH-X2-L0Y	M, I, S, HS, LH, H, EH, HLM	250	113,398			50	500

‡Cable tie cross section sizes: M = Miniature, I = Intermediate, S = Standard, HS = Heavy-Standard, LH = Light-Heavy, H = Heavy, EH = Extra-Heavy and HLM = Miniature *TAK-TY*® Hook & Loop Ties.

A. System Overview

B1. Cable Ties

B2. Cable Accessories

B3. Stainless Steel Ties

C1. Wiring Duct

C2. Surface Raceway

C3. Abrasion Protection

C4. Cable Management

D1. Terminals

D2. Power Connectors

D3. Grounding Connectors

E1. Labeling Systems

E2. Labels

E3. Pre-Printed & Write-On Markers

E4. Permanent Identification

E5. Lockout/Tagout & Safety Solutions

F. Index

A. System Overview

Stud Tie Mounts

B1. Cable Ties

- Easily applied to bolts or studs with a light hammer blow or turning of the mount
- Material: Impact Modified Weather Resistant Nylon 6.6
- Designed for use with cable ties to route and secure cable bundles, air, water and hydraulic lines

B2. Cable Accessories



B3. Stainless Steel Ties

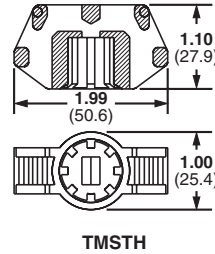
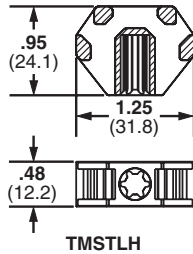

C1. Wiring Duct

C2. Surface Raceway

C3. Abrasion Protection

C4. Cable Management

Part Number	Used with Cable Ties‡	Color	Environment	Mounting Method	Std. Pkg. Qty.	Std. Ctn. Qty.
TMSTLHS6-M0	M, I, S, HS, LH	Black	Outdoors	1/4" stud dia. (6mm)	1000	5000
TMSTLHS8-M0	M, I, S, HS, LH			5/16" stud dia. (8mm)	1000	5000
TMSTHS10-D0	M, I, S, HS, LH, H			3/8" stud dia. (10mm)	500	—
TMSTHS13-D0	M, I, S, HS, LH, H			1/2" stud dia. (13mm)	500	—
TMSTHS16-D0	M, I, S, HS, LH, H			5/8" stud dia. (16mm)	500	—
TMSTHS19-D0	M, I, S, HS, LH, H			3/4" stud dia. (19mm)	500	—

‡Cable tie cross section sizes: M = Miniature, I = Intermediate, S = Standard, HS = Heavy Standard, LH = Light-Heavy and H = Heavy.

D1. Terminals

Tie Anchor Mounts – Screw Applied

- 4-way cable tie entry makes part orientation fast and easy
- Small overall size allows for use where space is limited

D2. Power Connectors

D3. Grounding Connectors

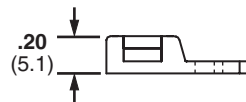
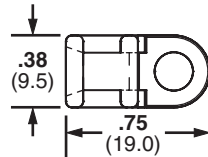

E1. Labeling Systems

E2. Labels

E3. Pre-Printed & Write-On Markers

E4. Permanent Identification

E5. Lockout/Tagout & Safety Solutions

F. Index

Part Number	Used with Cable Ties‡	Hole Diameter		Material	Color	Environment	Mounting Method	Std. Pkg. Qty.	Std. Ctn. Qty.
		In.	mm						
TA1S8-C	M, I, S	.17	4.3	Nylon 6.6	Natural	Indoors	#8 (M4) Screw	100	500
TA1S8-M0		.17	4.3	Weather Resistant Nylon 6.6	Black	Outdoors	#8 (M4) Screw	1000	5000
TA1S8-M30		.17	4.3	Heat Stabilized Nylon 6.6	Black	Indoors	#8 (M4) Screw	1000	5000
TA1S8-M69		.17	4.3	Flame Retardant Nylon 6.6	Natural	Indoors	#8 (M4) Screw	1000	5000
TA1S10-C		.17	4.3	Nylon 6.6	Natural	Indoors	#10 (M5) Screw	100	500
TA1S10-M0		.20	5.1	Weather Resistant Nylon 6.6	Black	Outdoors	#10 (M5) Screw	1000	5000
SGTA1S8-C		SGM, SGI, SGS	.17	4.3	Nylon 6.6	Natural	Indoors	#8 (M4) Screw	100

‡Cable tie cross section sizes: M = Miniature, I = Intermediate, S = Standard, SGM = SUPER-GRIP® Miniature, SGI = SUPER-GRIP® Intermediate and SGS = SUPER-GRIP® Standard.

Tie Anchor Mounts

- Install perpendicular to the wire bundle
- Elongated slot permits cable bundle adjustment in application

- Low profile design keeps bundle close to mounting surface where overhead space is limited
- Material: Nylon 6.6

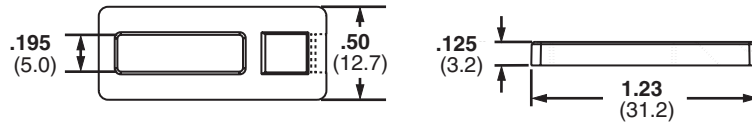
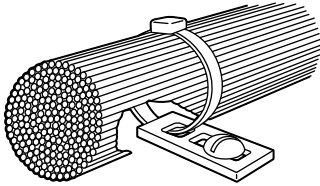

Part Number	Used with Cable Ties‡	Color	Environment	Mounting Method	Std. Pkg. Qty.	Std. Ctn. Qty.
TA2-C	M, I, S	Natural	Indoors	#10 (M5) Screw	100	1000
TA2-M					1000	5000

‡Cable tie cross section sizes: M = Miniature, I = Intermediate, and S = Standard.

Low Profile Mounts – Screw Applied

- Low profile design keeps bundle close to mounting surface
- Small overall size
- Install with a screw or rivet for a strong, secure installation

- For indoor use only
- Material: Nylon 6.6

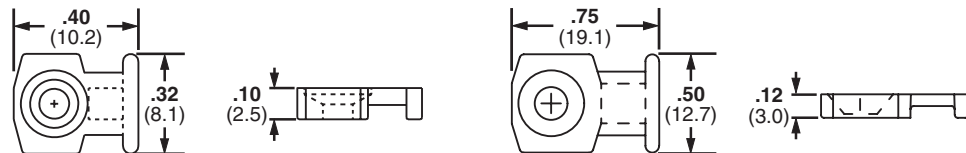

LPMM

Part Number	Used with Cable Ties‡	Color	Mounting Method	Std. Pkg. Qty.	Std. Ctn. Qty.
LPMM-S2-C	M	Natural	#2 (M2) Countersunk Screw	100	1000
LPMM-S5-C	M		#5 (M3) Countersunk Screw	100	1000
LPMS-S8-C	M, I, S		#8 (M4) Countersunk Screw	100	1000

‡Cable tie cross section sizes: M = Miniature, I = Intermediate, and S = Standard.

HYPER-V™ Cable Tie Mounts

- Tie mount has retaining tab within window to hold cable tie in position when pre-installed in the mount; low profile design keeps bundle close to mounting surface

- For use with *HYPER-V™* Cable Ties on page B1.62
- For outdoor use
- Material: Weather Resistant Nylon 6.6

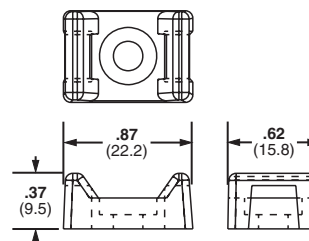

Part Number	Used with Cable Ties‡	Color	Mounting Method	Std. Pkg. Qty.	Std. Ctn. Qty.
HVTM3S10-C0	HV	Black	#10 (6mm) Screw	100	500

‡Cable tie cross section size: HV = *HYPER-V™* Cable tie.

A.
System
Overview

B1.
Cable Ties

B2.
Cable
Accessories

B3.
Stainless
Steel Ties

C1.
Wiring
Duct

C2.
Surface
Raceway

C3.
Abrasion
Protection

C4.
Cable
Management

D1.
Terminals

D2.
Power
Connectors

D3.
Grounding
Connectors

E1.
Labeling
Systems

E2.
Labels

E3.
Pre-Printed
& Write-On
Markers

E4.
Permanent
Identification

E5.
Lockout/
Tagout/
& Safety
Solutions

F.
Index

A. System Overview

SUPER-GRIP® Tie Mounts

- Unique cradle design provides maximum stability for the cable bundle
- Low profile design keeps bundle close to mounting surface

- SUPER-GRIP® Cable Ties on page B1.38
- For indoor use only

B1. Cable Ties

B2. Cable Accessories



B3. Stainless Steel Ties

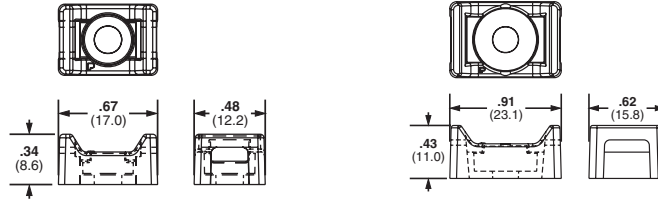

C1. Wiring Duct

C2. Surface Raceway

C3. Abrasion Protection

C4. Cable Management

Part Number	Used with Cable Ties‡	Material	Color	Mounting Method	Std. Pkg. Qty.	Std. Ctn. Qty.
SGTM1S6-C	SGM	Nylon 6.6	Natural	#6 (M3) Screw	100	500
SGTM1S6-C0	SGM	Weather Resistant Nylon 6.6	Black	#6 (M3) Screw	100	500
SGTM2S8-C	SGM, SGI, SGS	Nylon 6.6	Natural	#8 (M4) Screw	100	500
SGTM2S8-C0	SGM, SGI, SGS	Weather Resistant Nylon 6.6	Black	#8 (M4) Screw	100	500
SGTM3S10-C	SGM, SGI, SGS, SGLH	Nylon 6.6	Natural	#10 (M5) Screw	100	500
SGTM3S10-C0	SGM, SGI, SGS, SGLH	Weather Resistant Nylon 6.6	Black	#10 (M5) Screw	100	500

‡Cable tie cross section sizes: SGM = SUPER-GRIP® Miniature, SGI = SUPER-GRIP® Intermediate, SGS = SUPER-GRIP® Standard and SGLH = SUPER-GRIP® Light-Heavy.

D1. Terminals

Low Profile Mounts – Push Rivet Applied

- Eliminate screws
- Secure wires to any pre-drilled panel
- Can be installed in any panel thickness

- Low profile design keeps bundle close to mounting surface
- For indoor use only
- Material: Nylon 6.6

D2. Power Connectors

D3. Grounding Connectors



E1. Labeling Systems

E2. Labels

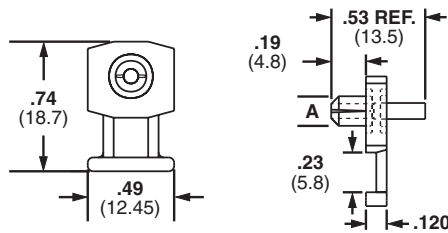

E3. Pre-Printed & Write-On Markers

E4. Permanent Identification

E5. Lockout/Tagout & Safety Solutions

F. Index

Part Number	Used with Cable Ties‡	Hole Diameter A		Color	Mounting Method	Std. Pkg. Qty.	Std. Ctn. Qty.
		In.	mm				
KIMS-H366-C2	M, I, S	.144	3.7	Red	Integral Push Rivet	100	1000
KIMS-H430-C6		.169	4.3	Blue	Integral Push Rivet	100	1000
KIMS-H500-C4		.196	5.0	Yellow	Integral Push Rivet	100	1000

‡Cable tie cross section sizes: M = Miniature, I = Intermediate, and S = Standard.

Cable Tie Plates

- Slotted mounting hole accommodates various fastener spacing
- Low profile design keeps bundle close to mounting surface
- For indoor use only
- Material: Nylon 6.6

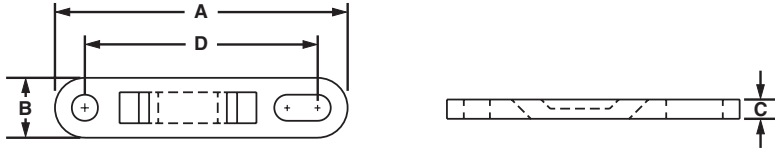
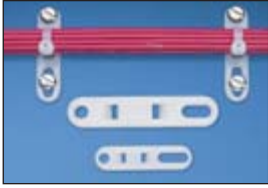

Part Number	Used with Cable Ties‡	Length A		Width B		Height C		Hole Spacing D		Color	Mounting Method	Std. Pkg. Qty.	Std. Ctn. Qty.
		In.	mm	In.	mm	In.	mm	In.	mm				
TP2-C	M, I, S	1.98	50.3	.50	12.7	.13	3.2	1.60	40.6	Natural	#10 (M5) Screw	100	1000
TP4H-C	M, I, S, HS, LH, H	3.08	78.2	.62	15.7	.20	5.2	2.50	63.5	Natural	1/4 (M6) Screw	100	1000

‡Cable tie cross section sizes: M = Miniature, I = Intermediate, S = Standard, HS = Heavy-Standard, LH = Light-Heavy and H = Heavy.

Multiple Tie Plates

- Used to secure closely spaced wire bundles
- Low profile design keeps bundle close to mounting surface
- For indoor use only
- Material: Nylon 6.6

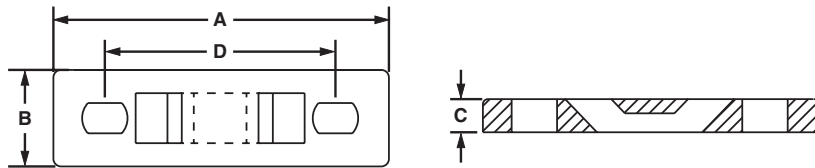

Part Number	No. of Bundles	Used with Cable Ties‡	Length A		Width B		Height C		Hole Spacing D		Mounting Method	Mil. Std. Part Number	Std. Pkg. Qty.	Std. Ctn. Qty.
			In.	mm	In.	mm	In.	mm	In.	mm				
MTP1S-E6-C	1	M, I, S	1.75	44.5	.50	12.7	.13	3.2	1.25	31.8	#6 (M3) Screw	MS3339-1-9	100	1000
MTP1S-E10-C			1.75	44.5	.50	12.7	.13	3.2	1.25	31.8	#10 (M5) Screw	—	100	1000
MTP1H-E6-C		M, I, S, HS, LH, H	2.09	53.1	.63	16.0	.20	5.2	1.50	38.1	#6 (M3) Screw	MS3339-6-9	100	1000
MTP1H-E10-C			2.09	53.1	.63	16.0	.20	5.2	1.50	38.1	#10 (M5) Screw	—	100	1000
MTP2S-E6-C	2	M, I, S	3.00	76.2	.50	12.7	.13	3.2	2.50	63.5	#6 (M3) Screw	MS3339-2-9	100	1000
MTP2S-E10-C			3.00	76.2	.50	12.7	.13	3.2	2.50	63.5	#10 (M5) Screw	—	100	1000
MTP2H-E6-C		M, I, S, HS, LH, H	3.59	91.2	.63	16.0	.20	5.2	3.00	76.2	#6 (M3) Screw	MS3339-7-9	100	1000
MTP2H-E10-C			3.59	91.2	.63	16.0	.20	5.2	3.00	76.2	#10 (M5) Screw	—	100	1000

‡Cable tie cross section sizes: M = Miniature, I = Intermediate, S = Standard, HS = Heavy-Standard, LH = Light-Heavy and H = Heavy.

Table continues on page B2.16

A. System Overview

Multiple Tie Plates (continued)

B1. Cable Ties

B2. Cable Accessories

B3. Stainless Steel Ties

C1. Wiring Duct

C2. Surface Raceway

C3. Abrasion Protection

C4. Cable Management

D1. Terminals

D2. Power Connectors

D3. Grounding Connectors

E1. Labeling Systems

E2. Labels

E3. Pre-Printed & Write-On Markers

E4. Permanent Identification

E5. Lockout/Tagout & Safety Solutions

F. Index

Part Number	No. of Bundles	Used with Cable Ties‡	Length A		Width B		Height C		Hole Spacing D		Mounting Method	Mil. Std. Part Number	Std. Pkg. Qty.	Std. Ctn. Qty.	
			In.	mm	In.	mm	In.	mm	In.	mm					
MTP3S-E6-C	3	M, I, S	4.25	108.0	.50	12.7	.13	3.2	3.75	95.3	#6 (M3) Screw	MS3339-3-9	100	1000	
MTP3S-E10-C			4.25	108.0	.50	12.7	.13	3.2	3.75	95.3	#10 (M5) Screw	—	100	1000	
MTP3H-E6-C		M, I, S, HS, LH, H	5.09	129.3	.63	16.0	.20	5.2	4.50	114.3	#6 (M3) Screw	MS3339-8-9	100	1000	
MTP3H-E10-C			5.09	129.3	.63	16.0	.20	5.2	4.50	114.3	#10 (M5) Screw	—	100	1000	
MTP4S-E6-C	4	M, I, S	5.50	139.7	.50	12.7	.13	3.2	5.00	127.0	#6 (M3) Screw	MS3339-4-9	100	1000	
MTP4S-E10-C			5.50	139.7	.50	12.7	.13	3.2	5.00	127.0	#10 (M5) Screw	—	100	1000	
MTP4H-E6-C		M, I, S, HS, LH, H	6.59	167.4	.63	15.7	.20	5.2	6.00	152.4	#6 (M3) Screw	MS3339-9-9	100	1000	
MTP4H-E10-C			6.59	167.4	.63	15.7	.20	5.2	6.00	152.4	#10 (M5) Screw	—	100	1000	
MTP5S-E6-C	5	M, I, S	6.75	171.5	.50	12.7	.13	3.2	6.25	158.8	#6 (M3) Screw	MS3339-5-9	100	1000	
MTP5S-E10-C			6.75	171.5	.50	12.7	.13	3.2	6.25	158.8	#10 (M5) Screw	—	100	1000	
MTP5H-E6-C		M, I, S, HS, LH, H	8.09	205.5	.63	16.0	.20	5.2	7.50	190.5	#6 (M3) Screw	MS3339-10-9	100	1000	
MTP5H-E10-C			8.09	205.5	.63	16.0	.20	5.2	7.50	190.5	#10 (M5) Screw	—	100	1000	
MTP6H-E6-C			6	9.59	243.6	.63	16.0	.20	5.2	9.00	228.6	#6 (M3) Screw	MS3339-11-9	100	1000
MTP6H-E10-C				9.59	243.6	.63	16.0	.20	5.2	9.00	228.6	#10 (M5) Screw	—	100	1000

Contour Multiple Tie Plates

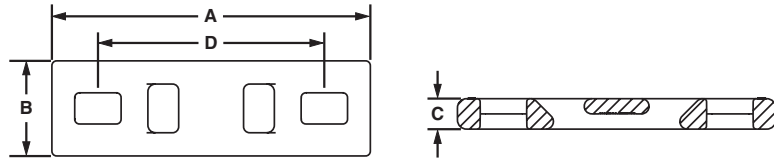

Part Number	No. of Bundles	Used with Cable Ties‡	Length A		Width B		Height C		Hole Spacing D		Mounting Method	Mil. Std. Part Number	Std. Pkg. Qty.	Std. Ctn. Qty.
			In.	mm	In.	mm	In.	mm	In.	mm				
MTPC1H-E10-C39	1	M, I, S, HS, LH, H	2.09	53.1	.63	16.0	.20	5.2	1.5	38.1	#10 (M5) Screw	—	100	1000
MTPC2H-E10-C39	2		3.59	91.2	.63	16.0	.20	5.2	3.0	6.2	#10 (M5) Screw	—	100	1000
MTPC3H-E10-C39	3		5.09	129.3	.63	16.0	.20	5.2	4.50	114.3	#10 (M5) Screw	—	100	1000
MTPC4H-E10-C39	4		6.59	167.4	.63	15.7	.20	5.2	6.00	152.4	#10 (M5) Screw	—	100	1000
MTPC5H-E10-C39	5		8.09	205.5	.63	16.0	.20	5.2	7.50	190.5	#10 (M5) Screw	—	100	1000
MTPC6H-E10-C39	6		9.59	243.6	.63	16.0	.20	5.2	9.00	228.6	#10 (M5) Screw	—	100	1000

‡Cable tie cross section sizes: M = Miniature, I = Intermediate, S = Standard, HS = Heavy-Standard, LH = Light-Heavy and H = Heavy.

Right Angle Mounts

- Hold cable bundles away from the sharp edges of bulkheads or cabinet holes
- For indoor use only
- Can also be used to mount cable bundles adjacent to any surface
- Material: Nylon 6.6

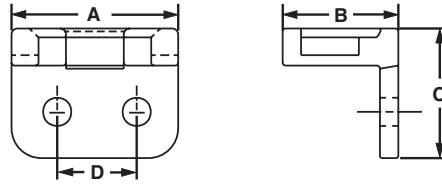

Part Number	Used with Cable Ties‡	Length A		Width B		Height C		Hole Spacing D		Color	Mil. Std. Part Number	Mounting Method	Std. Pkg. Qty.	Std. Ctn. Qty.
		In.	mm	In.	mm	In.	mm	In.	mm					
RAMS-S3-M	M, I, S	.56	14.2	.39	9.9	.44	11.0	.28	7.1	Natural	MS3341-2-9	#3 (M2.5) Screw or 3/32 (2.4) Rivet	1000	5000
RAMH-S6-D	M, I, S, HS, LH, H	1.00	25.4	.75	19.1	1.00	25.4	.28	7.1		MS3341-1-9	#6 (M3) Screw or 1/8 (3.2) Rivet	500	5000
RAMH-S10-D	M, I, S, HS, LH, H	1.00	25.4	.75	19.1	1.00	25.4	.50	12.7		—	#10 (M5) Screw or 3/16 (4.7) Rivet	500	5000

‡Cable tie cross section sizes: M = Miniature, I = Intermediate, S = Standard, HS = Heavy Standard, LH = Light-Heavy and H = Heavy.

Lightening Hole Mounts

- Secure cable bundles that run through bulkhead lightening holes
- For indoor use only
- Protect cable bundles from sharp edges
- Material: Nylon 6.6

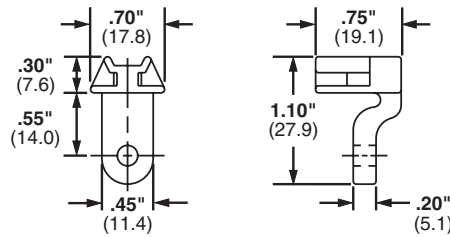

Part Number	Used with Cable Ties‡	Color	Mil. Std. Part Number	Mounting Method	Std. Pkg. Qty.	Std. Ctn. Qty.
LHMS-S5-D	M, I, S	Natural	—	#5 (M3) Screw or 1/8 (3.2) Rivet	500	2500
LHMS-S6-D			MS3340-1-9	#6 (M3) Screw or 9/64 (3.5) Rivet	500	2500
LHMS-S10-D			—	#10 (M5) Screw or 3/16 (4.7) Rivet	500	2500

‡Cable tie cross section sizes: M = Miniature, I = Intermediate, and S = Standard.

A.
System
Overview

B1.
Cable Ties

B2.
Cable
Accessories

B3.
Stainless
Steel Ties

C1.
Wiring
Duct

C2.
Surface
Raceway

C3.
Abrasion
Protection

C4.
Cable
Management

D1.
Terminals

D2.
Power
Connectors

D3.
Grounding
Connectors

E1.
Labeling
Systems

E2.
Labels

E3.
Pre-Printed
& Write-On
Markers

E4.
Permanent
Identification

E5.
Lockout/
Tagout/
& Safety
Solutions

F.
Index

A. System Overview

Metal Clip-On Mounts

- Clips on sheet metal edges for fast mounting of harness with cable ties
- Allows cable tie entry from all four sides for easy harness orientation
- For indoor use only
- Material: Zinc plated steel

B1. Cable Ties

B2. Cable Accessories

B3. Stainless Steel Ties

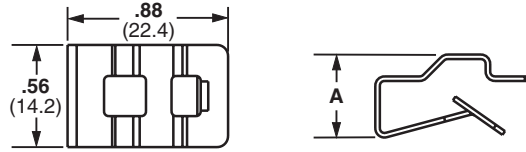

Part Number	Used with Cable Ties‡	Height A		Max. Panel Thickness		Mounting Method	Std. Pkg. Qty.	Std. Ctn. Qty.
		In.	mm	In.	mm			
MCMS12-P-C	M, I, S	.31	8.0	.13	3.2	Clip-On	100	500
MCMS25-P-C		.46	11.5	.24	6.1		100	500
MCMS30-P-C		.55	14.0	.27	6.9		100	500

‡Cable Tie Cross Section Sizes: M = Miniature, I = Intermediate, and S = Standard.

C1. Wiring Duct

C2. Surface Raceway

C3. Abrasion Protection

Metal Screw-On Mount

- Screw applied aluminum mounting base for a secure support in demanding applications

C4. Cable Management



D1. Terminals

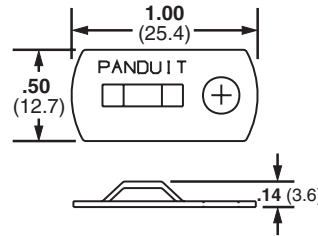

D2. Power Connectors

Part Number	Used with Cable Ties‡	Material	Environment	Mounting Method	Max. Static Load		Std. Pkg. Qty.	Std. Ctn. Qty.
					Lbs.	g		
MBMS-S10-CY	M, I, S	Aluminum	Indoors/Outdoors	#10 (M5) Screw	10.00	4540	100	1000

‡Cable Tie Cross Section Sizes: M = Miniature, I = Intermediate, and S = Standard.

D3. Grounding Connectors

E1. Labeling Systems

Push Barb Cable Tie Mounts

- Wing provides added stability
- Requires no adhesive or additional mounting hardware
- Can be used where only one side of the panel is accessible

E2. Labels



E3. Pre-Printed & Write-On Markers

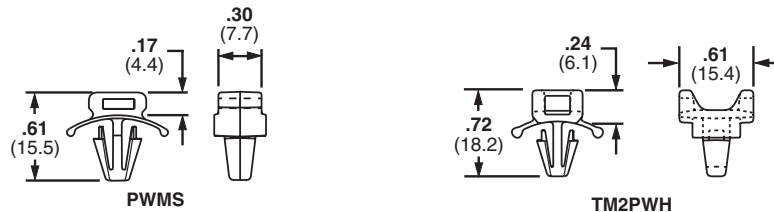

E4. Permanent Identification

Part Number	Used with Cable Ties‡	Max. Panel Thickness		Panel Hole Diameter		Material	Color	Environment	Mounting Method	Std. Pkg. Qty.	Std. Ctn. Qty.
		In.	mm	In.	mm						
PWMS-H25-C	M, I, S	.11	2.7	.25	6.5	Nylon 6.6	Natural	Indoors	Push Barb	100	1000
PWMS-H25-M0		.11	2.7	.25	6.5	Weather Resistant Nylon 6.6	Black	Outdoors	Push Barb	1000	5000
TM2PWH25-C		.10	2.3	.25	6.5	Nylon 6.6	Natural	Indoors	Push Barb	100	500

‡Cable tie cross section Sizes: M = Miniature, I = Intermediate, and S = Standard.

F. Index

Push Mounts

- Require no adhesive or additional mounting hardware
- Can be used where only one side of the panel is accessible

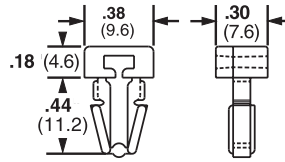

Part Number	Used with Cable Ties‡	Max. Panel Thickness		Panel Hole Diameter		Material	Color	Environment	Mounting Method	Std. Pkg. Qty.	Std. Ctn. Qty.
		In.	mm	In.	mm						
PM2H25-C	M, I, S	.125	3.2	.250	6.4	Nylon 6.6	Natural	Indoors	Push Barb	100	500
PM2H25-M0		.125	3.2	.250	6.4	Weather Resistant Nylon 6.6	Black	Outdoors		1000	5000
PM2H25-M30		.125	3.2	.250	6.4	Heat Stabilized Nylon 6.6	Black	Indoors		1000	5000

‡Cable tie cross section sizes: M = Miniature, I = Intermediate, and S = Standard.

Push Button Mount

- Require no adhesive or additional mounting hardware
- Designed for use where both sides of the panel are accessible

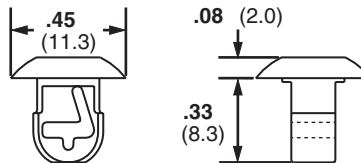

Part Number	Used with Cable Ties‡	Max. Panel Thickness		Panel Hole Diameter		Material	Color	Environment	Mounting Method	Std. Pkg. Qty.	Std. Ctn. Qty.
		In.	mm	In.	mm						
PBMS-H25-C	M, I, S	.13	3.2	.25	6.4	Nylon 6.6	Natural	Indoors	Push Barb	100	1000
PBMS-H25-C14		.13	3.2	.25	6.4	Nylon 6.6	Gray	Indoors		100	1000
PBMS-H25-M0		.13	3.2	.25	6.4	Weather Resistant Nylon 6.6	Black	Outdoors		1000	5000
PBMS-H25-M30		.13	3.2	.25	6.4	Heat Stabilized Nylon 6.6	Black	Indoors		1000	5000
PBMSL-H25-C30		.29	7.2	.25	6.4	Heat Stabilized Nylon 6.6	Black	Indoors		100	1000
PBMSL-H25-M30		.29	7.2	.25	6.4	Heat Stabilized Nylon 6.6	Black	Indoors		1000	5000

‡Cable tie cross section sizes: M = Miniature, I = Intermediate, and S = Standard.

A. System Overview

B1. Cable Ties

B2. Cable Accessories

B3. Stainless Steel Ties

C1. Wiring Duct

C2. Surface Raceway

C3. Abrasion Protection

C4. Cable Management

D1. Terminals

D2. Power Connectors

D3. Grounding Connectors

E1. Labeling Systems

E2. Labels

E3. Pre-Printed & Write-On Markers

E4. Permanent Identification

E5. Lockout/Tagout & Safety Solutions

F. Index

A. System Overview

Masonry Push Mounts

- Used to secure wire, cable, or tubing to masonry surfaces
- Installed quickly into pre-drilled holes; design holds bundle securely
- Material: Impact Modified Weather Resistant Nylon 6.6

B1. Cable Ties

B2. Cable Accessories

B3. Stainless Steel Ties

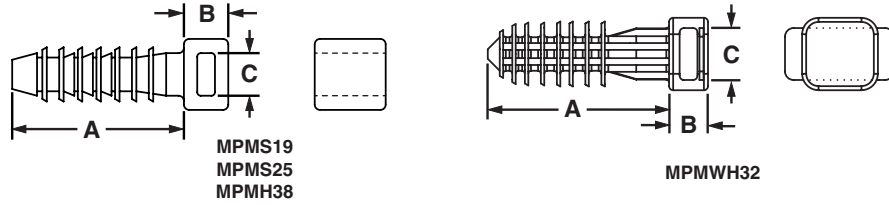

C1. Wiring Duct

C2. Surface Raceway

C3. Abrasion Protection

C4. Cable Management

Part Number	Used with Cable Ties‡	Grip Length A		Height B		Hole Diameter C		Color	Environment	Mounting Method	Std. Pkg. Qty.	Std. Ctn. Qty.
		In.	mm	In.	mm	In.	mm					
MPMS19-C0	M, I, S	.97	24.6	.25	6.4	.19	5.0	Black	Outdoors	Tree Barb	100	500
MPMS25-C0		.97	24.6	.27	6.9	.25	6.4					
MPMH38-L0		M, I, S, HS, LH, H, HLM	1.25	31.8	.30	7.5	.38					
MPMWH32-L0	M, I, S, HS, LH, H, HLM	1.41	35.8	.28	7.1	.32	8.0					

‡Cable Tie Cross Section Sizes: M = Miniature, I = Intermediate, S = Standard, HS = Heavy-Standard, LH = Light-Heavy, H = Heavy and HLM = Miniature *TAK-TY*® Hook & Loop Ties.

D1. Terminals

D2. Power Connectors

D3. Grounding Connectors

E1. Labeling Systems

E2. Labels

E3. Pre-Printed & Write-On Markers

E4. Permanent Identification

E5. Lockout/Tagout & Safety Solutions

F. Index

NEW! **SUPER-GRIP® Masonry Push Mounts**

- Used to secure wire, cable, or tubing to masonry surfaces
- Installed quickly into pre-drilled holes; design holds bundle securely
- For use with *SUPER-GRIP*® Cable Ties found on page B1.38
- Material: Impact Modified Weather Resistant Nylon 6.6

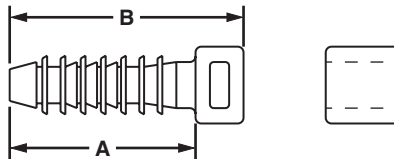

Part Number	Used with Cable Ties‡	Grip Length A		Height B		Hole Diameter		Color	Environment	Mounting Method	Std. Pkg. Qty.	Std. Ctn. Qty.
		In.	mm	In.	mm	In.	mm					
SGMPMS19-C0	SGM, SGI, SGS	.97	24.6	.25	6.4	.19	5.0	Black	Indoors/ Outdoors	Tree Barb	100	500
SGMPMS25-C0		.97	24.6	.27	6.9	.25	6.4					
SGMPMH38-L0	SGM, SGI, SGS, SGLH, SGH	1.25	31.8	.30	7.5	.38	9.5					
SGMPMWH32-L0		1.41	35.8	.28	7.1	.32	8.0					

‡Cable tie cross section sizes: SGM = *SUPER-GRIP*® Miniature, SGI = *SUPER-GRIP*® Intermediate, SGS = *SUPER-GRIP*® Standard, SGLH = *SUPER-GRIP*® Light-Heavy, SGH = *SUPER-GRIP*® Heavy.



HYPER-V™ Masonry Cable Tie Mounts

- Used to secure wire, cable, or tubing to masonry surfaces
- Material: Impact Modified Weather Resistant Nylon 6.6
- For use with *HYPER-V™* Cable Ties found on page B1.62

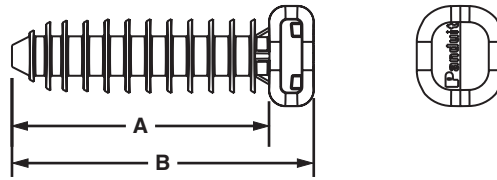

Part Number	Used with Cable Ties‡	Grip Length A		Height B		Hole Diameter		Color	Environment	Mounting Method	Std. Pkg. Qty.	Std. Ctn. Qty.
		In.	mm	In.	mm	In.	mm					
HVMPM32-C0	HV	1.41	35.8	1.63	41.4	.31	8.0	Black	Outdoors	Tree barb for .31" (7.9mm) hole diameter	100	500

‡Cable tie cross section size: HV = *HYPER-V™* Cable Ties.

Wood Push Mount

- Used to secure wire, cable, or tubing to wood surfaces
- Barbed design holds mount in place – rated for 60 lb. pullout

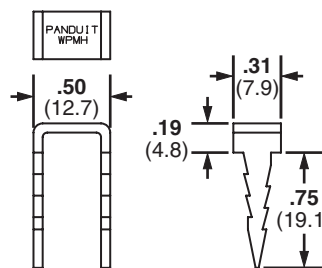

Part Number	Used with Cable Ties‡	Material	Environment	Mounting Method	Std. Pkg. Qty.
WPMH-C	M, I, S, HS, LH, H, HLM	Plated Steel	Indoors/Outdoors	Hammer into wood	100

‡Cable tie cross section sizes: M = Miniature, I = Intermediate, S = Standard, HS = Heavy Standard, LH = Light-Heavy, H = Heavy and HLM = Miniature *TAK-TY®* Hook & Loop Ties.

- A. System Overview
- B1. Cable Ties
- B2. Cable Accessories
- B3. Stainless Steel Ties
- C1. Wiring Duct
- C2. Surface Raceway
- C3. Abrasion Protection
- C4. Cable Management
- D1. Terminals
- D2. Power Connectors
- D3. Grounding Connectors
- E1. Labeling Systems
- E2. Labels
- E3. Pre-Printed & Write-On Markers
- E4. Permanent Identification
- E5. Lockout/Tagout & Safety Solutions
- F. Index

A. System Overview



Push Mounts with Umbrella

B1. Cable Ties

- Unique alternating barb design
- Lock securely into position
- Umbrella tensioning

- Exclusive contoured anvil head
- Material: Heat Stabilized Nylon 6.6

B2. Cable Accessories

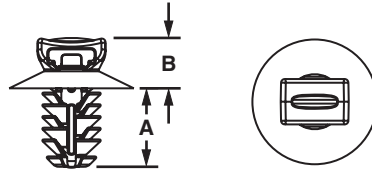

B3. Stainless Steel Ties

C1. Wiring Duct

C2. Surface Raceway

C3. Abrasion Protection

C4. Cable Management

Part Number	Used with Cable Ties‡	Head Diameter		Panel to Top of Mount		Overall Height		Panel Hole Diameter Range		Panel Thickness Range		Std. Pkg. Qty.	Std. Ctn. Qty.
		In.	mm	In.	mm	In.	mm	In.	mm	In.	mm		
PUM-049-M30	M, I, S	.67	17.0	.26	6.6	.54	13.8	.18 – .19	4.6 – 4.9	.03 – .19	0.7 – 3.0	1000	5000
PUM-071-M30	M, I, S	.67	17.0	.26	6.5	.67	16.9	.25 – .28	6.3 – 7.1	.03 – .28	0.8 – 7.0	1000	5000
PUM-100-M30	M, I, S	.64	16.0	.26	6.5	.67	16.9	.35 – .40	9.0 – 10.0	.03 – .28	0.8 – 7.0	1000	5000
PUM-925-M30	M, I, S, LH	.77	20.0	.30	7.6	1.05	26.7	.34 – .36	8.8 – 9.3	.04 – .62	1.0 – 16.0	1000	5000

‡Use with PLT2S-M30 cable tie.

D1. Terminals

D2. Power Connectors

D3. Grounding Connectors

E1. Labeling Systems

E2. Labels

E3. Pre-Printed & Write-On Markers

E4. Permanent Identification

E5. Lockout/Tagout & Safety Solutions

F. Index



Push Mount Assemblies

- Cable tie/mount assemblies significantly reduce installation time compared to loose parts
- Fewer parts throughout the manufacturing/assembly process

- Heat Stabilized Nylon 6.6 standard on cable ties and mounts
- Maximum bundle diameter: 1.88 inches (4.8mm)

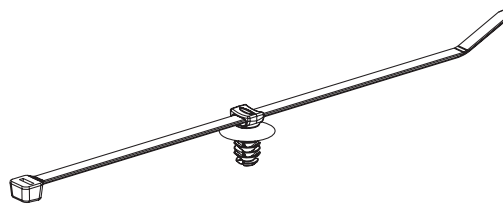

Part Number‡	Head Diameter		Panel to Top of Mount		Overall Height		Panel Hole Diameter Range		Panel Thickness Range		Std. Pkg. Qty.	Std. Ctn. Qty.
	In.	mm	In.	mm	In.	mm	In.	mm	In.	mm		
PUM-049-2S-D30	.67	17.0	.26	6.6	.54	13.8	.18 – .19	4.6 – 4.9	.03 – .19	0.7 – 3.0	500	5000
PUM-071-2S-D30	.67	17.0	.26	6.5	.67	16.9	.25 – .28	6.3 – 7.1	.03 – .28	0.8 – 7.0	500	5000
PUM-100-2S-D30	.64	16.0	.26	6.5	.67	16.9	.35 – .40	9.0 – 10.0	.03 – .28	0.8 – 7.0	500	5000
PUM-925-2S-D30	.77	20.0	.30	7.6	1.05	26.7	.34 – .36	8.8 – 9.3	.04 – .62	1.0 – 16.0	500	5000

‡Push mount with PLT2S Cable Ties – 1.88"(4.8mm) – maximum bundle diameter

Control Panel Mounts

- Installed behind control panel switch
- Ideal for high strain areas where cable is routed from panel to panel door
- Compatible with most control panel switch designs
- Indoor use only

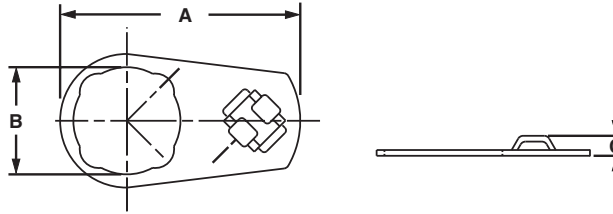

Part Number	Used with Cable Ties‡	Length A		Width B		Height C		Material	Mounting Method	Std. Pkg. Qty.	Std. Ctn. Qty.
		In.	mm	In.	mm	In.	mm				
CPM87S-C	M, I, S	2.01	51.1	.89	22.6	.17	4.3	Zinc plated steel	Control panel switch	100	1000
CPM122S-C	M, I, S	2.82	71.7	1.22	31.0	.17	4.3	Zinc plated steel	Control panel switch	100	1000

‡Cable tie cross section sizes: M = Miniature, I = Intermediate, and S = Standard.

PAN-POST™ Standoff

- Supports cable bundles above or away from surface
- For indoor use only
- Material: Nylon 6.6

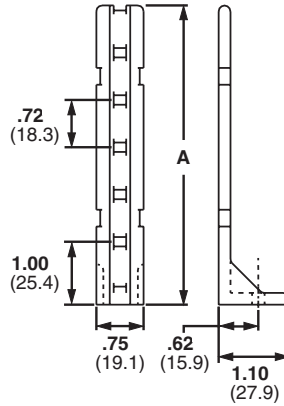

Part Number	Used with Cable Ties‡	Height A		Color	Mounting Method	Std. Pkg. Qty.	Std. Ctn. Qty.
		In.	mm				
PP1S-S10-X	M, I, S	2.00	50.8	Natural	#10 (M5) Screw	10	100
PP1S-S12-X		2.00	50.8		#12 (M5.5) Screw	10	100
PP2S-S10-X		4.60	116.8		#10 (M5) Screw	10	100
PP2S-S12-X		4.60	116.8		#12 (M5.5) Screw	10	100

‡Cable tie cross section sizes: M = Miniature, I = Intermediate, and S = Standard.

A.
System
Overview

B1.
Cable Ties

B2.
Cable
Accessories

B3.
Stainless
Steel Ties

C1.
Wiring
Duct

C2.
Surface
Raceway

C3.
Abrasion
Protection

C4.
Cable
Management

D1.
Terminals

D2.
Power
Connectors

D3.
Grounding
Connectors

E1.
Labeling
Systems

E2.
Labels

E3.
Pre-Printed
& Write-On
Markers

E4.
Permanent
Identification

E5.
Lockout/
Tagout
& Safety
Solutions

F.
Index

A. System Overview

Flat PAN-POST™ Standoffs

- Standard EIA hole spacing allows product to be mounted with user supplied screws up to 1/4" diameter
- Organize cables in standard cabinets and racks
- Mounting method: 1/4" (M6) screw
- Use where space is limited
- For indoor use only

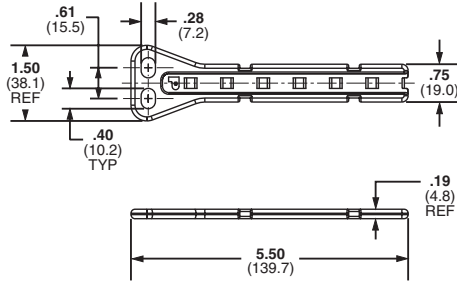

PPF2S

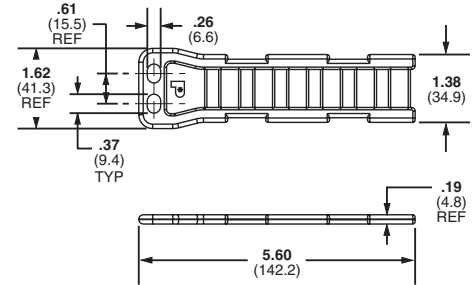

PPF2SV

B1. Cable Ties

B2. Cable Accessories

B3. Stainless Steel Ties

C1. Wiring Duct

C2. Surface Raceway

C3. Abrasion Protection

C4. Cable Management

Part Number	Used with Cable Ties‡	Material	Color	Mounting Method	Std. Pkg. Qty.	Std. Ctn. Qty.
PPF2S-S25-V	M, I, S	Nylon 6.6	Natural	Two 1/4" (M6) screws	5	100
PPF2S-S25-V69		Flame Retardant Nylon 6.6				
PPF2SV-S25-V	M, I, S, HS, LH, H, HLM, HLS	Nylon 6.6				
PPF2SV-S25-V69		Flame Retardant Nylon 6.6				

‡Cable Tie Cross Section Sizes: M = Miniature, I = Intermediate, S = Standard, HS = Heavy-Standard, LH = Light-Heavy, H = Heavy, HLM = Miniature T_{AK-TY}® Hook & Loop Ties and HLS = Standard T_{AK-TY}® Hook & Loop Ties .

D1. Terminals

Right Angle Bases

- Support cable above the mounting surface

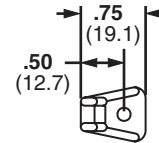
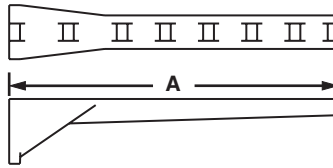

D2. Power Connectors

D3. Grounding Connectors

E1. Labeling Systems

Part Number	Used with Cable Ties‡	Max. Flat Cable Width		Length A		Material	Color	Environment	Mounting Method	Std. Pkg. Qty.	Std. Ctn. Qty.
		In.	mm	In.	mm						
RAFCBI1-S6-C20	I	1.00	25.4	1.75	44.4	Nylon 6.6	Black	Indoors	#6 (M3) Screw	100	1000
RAFCBI2-S6-C20	I	2.00	50.8	2.78	70.6						
RAFCBI3-S6-C20	I	3.00	76.2	3.81	96.8						

‡Cable tie cross section sizes: I = Intermediate.

E2. Labels

E3. Pre-Printed & Write-On Markers

E4. Permanent Identification

E5. Lockout/Tagout & Safety Solutions

F. Index

Flat Cable Mounting System – FCB Base and FCPI Plate

- Secures stacked cables, folds, and breakouts, as well as laminated and molded bus bars
- Use one base, one corresponding size plate (FCPI), and one intermediate cross section cable tie
- For indoor use only
- Material: Nylon 6.6

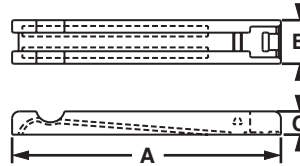

FCPI

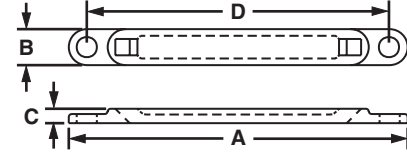

Part Number	Max. Flat Cable Width		Length A		Width B		Height C		Hole Spacing D		Color	Mounting Method	Std. Pkg. Qty.	Std. Ctn. Qty.
	In.	mm	In.	mm	In.	mm	In.	mm	In.	mm				
FCBI1-A-C20	1.04	26.4	2.50	63.5	.38	9.5	.15	3.8	—	—	Black	User Supplied Adhesive	100	1000
FCBI2-A-C20	2.04	51.8	3.50	88.9	.38	9.5	.15	3.8	—	—		User Supplied Adhesive	100	1000
FCBI3-A-C20	3.32	7.72	4.52	114.8	.38	9.5	.15	3.8	—	—		User Supplied Adhesive	100	1000
FCBI1-S10-C20	1.04	26.4	2.50	63.5	.38	9.5	.15	3.8	2.08	52.8		#10 (M5) Screw	100	1000
FCBI2-S10-C20	2.04	51.8	3.50	88.9	.38	9.5	.15	3.8	3.10	78.7		#10 (M5) Screw	100	1000
FCBI3-S10-C20	3.32	77.2	4.52	114.8	.38	9.5	.15	3.8	4.12	104.6		#10 (M5) Screw	100	1000
FCPI1-C20*	1.04	26.4	1.29	32.8	.38	9.5	.20	5.1	—	—		Cable Ties	100	1000
FCPI2-C20*	2.04	51.8	2.31	58.7	.38	9.5	.20	5.1	—	—		Cable Ties	100	1000
FCPI3-C20*	3.32	77.2	3.32	84.3	.38	9.5	.20	5.1	—	—		Cable Ties	100	1000

*Recommend use with PLT21 cable ties.

A. System Overview

B1. Cable Ties

B2. Cable Accessories

B3. Stainless Steel Ties

C1. Wiring Duct

C2. Surface Raceway

C3. Abrasion Protection

C4. Cable Management

D1. Terminals

D2. Power Connectors

D3. Grounding Connectors

E1. Labeling Systems

E2. Labels

E3. Pre-Printed & Write-On Markers

E4. Permanent Identification

E5. Lockout/Tagout & Safety Solutions

F. Index

A. System Overview

Closed Connector Rings

- Connect multiple cable bundles

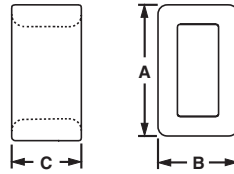

B1. Cable Ties

B2. Cable Accessories

B3. Stainless Steel Ties

C1. Wiring Duct

C2. Surface Raceway

Part Number	Used with Cable Ties‡	Length A		Width B		Height C		Material	Color	Environment	Mounting Method	Std. Pkg. Qty.	Std. Ctn. Qty.
		In.	mm	In.	mm	In.	mm						
CR2-M	M, I, S	.33	8.4	.20	5.1	.20	5.0	Nylon 6.6	Natural	Indoors	Cable Ties	1000	10000
CR4H-M	M, I, S, HS, LH	.57	14.5	.30	7.6	.36	9.1			Indoors			
CR4H-M0	M, I, S, HS, LH	.57	14.5	.30	7.6	.36	9.1	Weather Resistant Nylon 6.6	Black	Indoors/Outdoors			

‡Cable tie cross section sizes: M = Miniature, I = Intermediate, S = Standard, HS = Heavy-Standard and LH = Light-Heavy.

C3. Abrasion Protection

Open Connector Ring

- Designed to add on cable bundles without removing cable ties

C4. Cable Management

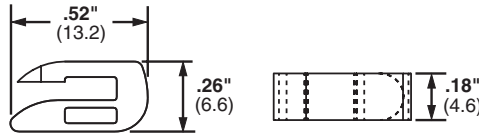

D1. Terminals

D2. Power Connectors

D3. Grounding Connectors

Part Number	Used with Cable Ties‡	Material	Color	Environment	Mounting Method	Std. Pkg. Qty.	Std. Ctn. Qty.
CROS-M	M, I, S	Nylon 6.6	Natural	Indoors	Cable Ties	1000	5000

‡Cable tie cross section sizes: M = Miniature, I = Intermediate, and S = Standard.

E1. Labeling Systems

Cable Spacers

- Used to separate and/or hang cords, cables, and tubing

E2. Labels

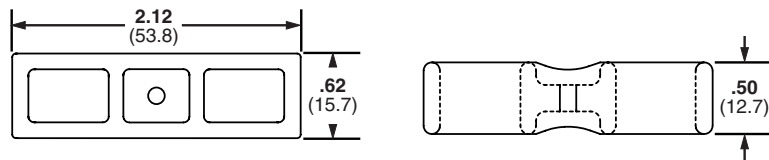

E3. Pre-Printed & Write-On Markers

E4. Permanent Identification

Part Number	Used with Cable Ties‡	Material	Color	Environment	Mounting Method	Std. Pkg. Qty.	Std. Ctn. Qty.
CSH-D20	M, I, S, HS, LH, H	Nylon 6.6	Black	Indoors	Cable Ties	500	2500
CSH-D0	M, I, S, HS, LH, H	Weather Resistant Nylon 6.6	Black	Indoors/Outdoors	Cable Ties	500	2500

‡Cable tie cross section sizes: M = Miniature, I = Intermediate, S = Standard, HS = Heavy-Standard, LH = Light-Heavy and H = Heavy.

E5. Lockout/Tagout & Safety Solutions

F. Index

Cable Spacer Cross

- Connects two bundles at 90°
- Separates bundles to prevent abrasion

- Dual cradle design stabilizes cable bundle

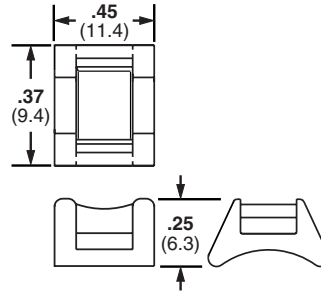

Part Number	Used with Cable Ties‡	Material	Color	Environment	Mounting Method	Std. Pkg. Qty.	Std. Ctn. Qty.
CSCS-M	M, I, S	Nylon 6.6	Natural	Indoors	Cable Ties	1000	10000

‡Cable tie cross section sizes: M = Miniature, I = Intermediate, and S = Standard.

Stackable Aerial Cable Spacer

- Greater resistance to damage caused by ultraviolet light – indoor or outdoor use
- Each spacer snaps into another to increase spacer heights by 1/2" increments

- Designed for use in parallel or perpendicular applications
- For use with *DURA-TY™* Cable Ties shown on page B1.53 or *PAN-STEEL®* Metal Locking Ties on page B3.7.

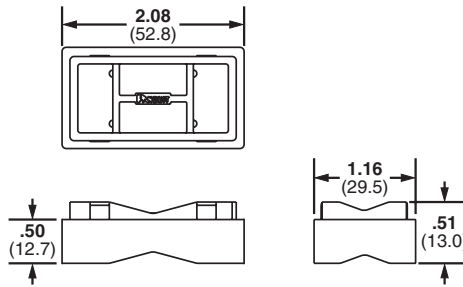

Part Number	Used with Cable Ties‡	Material	Color	Environment	Mounting Method	Std. Pkg. Qty.	Std. Ctn. Qty.
SACS50-T100	LH, H, EH	Weather Resistant Polypropylene	Black	Outdoors	Cable Ties	200	2000

‡Cable tie cross sizes: LH = Light-Heavy, H = Heavy, and EH = Extra-Heavy.

A.
System
Overview

B1.
Cable Ties

B2.
Cable
Accessories

B3.
Stainless
Steel Ties

C1.
Wiring
Duct

C2.
Surface
Raceway

C3.
Abrasion
Protection

C4.
Cable
Management

D1.
Terminals

D2.
Power
Connectors

D3.
Grounding
Connectors

E1.
Labeling
Systems

E2.
Labels

E3.
Pre-Printed
& Write-On
Markers

E4.
Permanent
Identification

E5.
Lockout/
Tagout/
& Safety
Solutions

F.
Index

A. System Overview

Aerial Support Ties – Weather Resistant Polypropylene

B1. Cable Ties

- Designed to attach coax or telephone cable to the 1/4" (6.4mm) or 5/16" (7.9mm) support strand to form the expansion loop and keep equipment and cables clear of pole hardware
- One-piece construction with integral 1/2" (12.7mm) spacer reduces inventory costs of separate spacer and bands, and installs faster to lower installed cost
- Releasable and re-usable
- Hand install only

B2. Cable Accessories

B3. Stainless Steel Ties

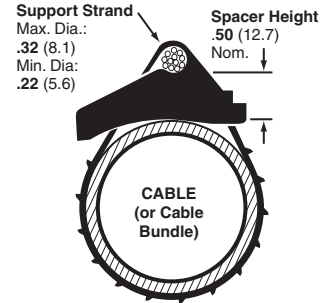
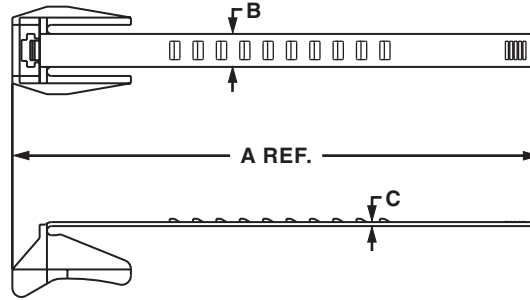

Assembled View

C1. Wiring Duct

C2. Surface Raceway

C3. Abrasion Protection

C4. Cable Management

Part Number	Length A		Width B		Thickness C		Max. Bundle Diameter		Min. Loop Tensile Strength		Std. Pkg. Qty.	Std. Ctn. Qty.
	In.	mm	In.	mm	In.	mm	In.	mm	Lbs.	N		
AST10-5-C100	5.6	142	.448	11.4	.055	1.4	1.00	25	75	334	100	1000
AST15-5-C100	6.9	175	.448	11.4	.055	1.4	1.50	38	75	334	100	1000
AST20-5-C100	8.4	214	.448	11.4	.055	1.4	2.00	51	75	334	100	1000
AST25-5-C100	10.0	254	.448	11.4	.055	1.4	2.50	64	75	334	100	1000

D1. Terminals

Permanent Marking Pens

D2. Power Connectors

- Fast drying, permanent ink for identification on marker ties (pages B1.34, B1.52, and B1.71), marker plates (page B2.29), or cable marker straps (page B1.80)
- May be used with any label shown in the catalog when a printer is not available

D3. Grounding Connectors



PX-0
PX-2



PFX-0
PFX-2



PX-10

E1. Labeling Systems

E2. Labels

E3. Pre-Printed & Write-On Markers

E4. Permanent Identification

E5. Lockout/Tagout & Safety Solutions

F. Index

Part Number	Color	Description	Std. Pkg. Qty.	Std. Ctn. Qty.
PX-0	Black	Permanent marking pen – regular tip.	12	144
PX-2	Red	Permanent marking pen – regular tip.	12	144
PFX-0	Black	Permanent marking pen – fine tip.	12	144
PFX-2	Red	Permanent marking pen – fine tip.	12	144
PX-10	White	Marking pen for black or other dark colored parts – regular tip.	12	300

Marker Plates – Loose Piece

- Install as flags, tags, or wrap-around identification plates to clearly identify all wire harnesses
- Use with nylon marking pens for an easy and economic alternative to identify wire harnesses
- Available in black or white to match the wire harness
- Thickness: .02 inches (0.5mm)

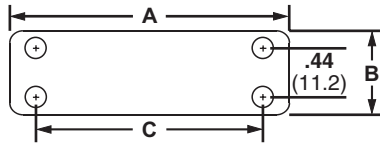

Part Number	Used with Cable Ties‡	Length A		Width B		Hole Spacing C		Material	Color	Environment	Mounting Method	Std. Pkg. Qty.	Std. Ctn. Qty.
		In.	mm	In.	mm	In.	mm						
Loose Piece													
MP150-C	M, I, S	1.50	38.1	.75	19.0	1.03	26.2	Nylon 6.6	White	Indoors	Cable Ties	100	500
MP175-C	M, I, S	1.75	44.4	.75	19.0	1.28	32.5					100	500
MP200-C	M, I, S	2.00	50.8	.75	19.0	1.53	38.9					100	500
MP250-C	M, I, S	2.50	63.5	.75	19.0	2.03	51.6					100	500
MP350-C	M, I, S	3.50	88.9	.75	19.0	3.03	77.7					100	1000
MP250W175-C	M, I, S	2.50	63.5	1.75	44.5	2.03	51.6					100	1000
MP150-C0	M, I, S	1.50	38.1	.75	19.0	1.03	26.2	Weather Resistant Nylon 6.6	Black	Indoors/Outdoors	Cable Ties	100	500
MP175-C0	M, I, S	1.75	44.4	.75	19.0	1.28	32.5					100	500
MP200-C0	M, I, S	2.00	50.8	.75	19.0	1.53	38.9					100	500
MP250-C0	M, I, S	2.50	63.5	.75	19.0	2.03	51.6					100	500
MP350-C0	M, I, S	3.50	88.9	.75	19.0	3.03	77.7					100	1000
Marker Plates on Rolls													
MP150-R	M, I, S	1.50	38.1	.75	19.0	1.03	26.2	Nylon 6.6	White	Indoors	Cable Ties	1000	5000
MP175-R	M, I, S	1.75	44.4	.75	19.0	1.28	32.5					1000	5000
MP200-R	M, I, S	2.00	50.8	.75	19.0	1.53	38.9					1000	5000
MP250-R	M, I, S	2.50	63.5	.75	19.0	2.03	51.6					1000	5000

‡Cable tie cross section sizes: M = Miniature, I = Intermediate, and S = Standard.

A. System Overview

Cable and Wire Mounting Devices (used without cable ties)

B1. Cable Ties

B2. Cable Accessories

B3. Stainless Steel Ties



Wiring accessories are an integral part of the *PANDUIT* comprehensive selection of wire management products.

These accessories are one piece solutions that help provide the lowest installed cost for controlling, mounting, and protecting wire and cable. Mounting methods include:

- Adhesive-backed
- Screw applied
- Rivet applied
- Push mounts

C1. Wiring Duct

C2. Surface Raceway

Adhesive Backed Mounting Devices

Faster Liner Removal Speeds Installation and Lowers Installed Cost

- The adhesive backed mounts are offered either as one or two mounts per liner
- The 2-up mounts are easily removed by bending the mounts away from the liner
- The individual mounts have a convenient tear tab for quick removal

C3. Abrasion Protection

C4. Cable Management

D1. Terminals

D2. Power Connectors

D3. Grounding Connectors

E1. Labeling Systems

E2. Labels

E3. Pre-Printed & Write-On Markers

E4. Permanent Identification

E5. Lockout/Tagout & Safety Solutions

F. Index

CLINCHER™ Adjustable Releasable Clamp

- Adjustable clamp designed to contain a range of cable bundle diameters
- Latch can be released to provide access to cable bundles
- For indoor use only
- Material: Polypropylene

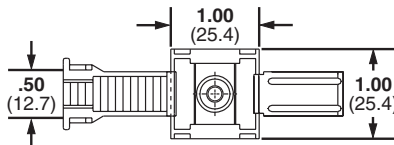

Part Number	Bundle Diameter Range		Color	Mounting Method	Max. Static Load		Std. Pkg. Qty.	Std. Ctn. Qty.
	In.	mm			Lbs.	g		
ARC.68-A-Q	.19 – .69	4.8 – 17.5	White	Rubber Adhesive	.50	227	25	250
ARC.68-A-Q14	.19 – .69	4.8 – 17.5	Gray	Rubber Adhesive	.50	227	25	250
ARC.68-S6-Q	.19 – .69	4.8 – 17.5	White	#6 (M3) Screw	—	—	25	250
ARC.68-S6-Q14	.19 – .69	4.8 – 17.5	Gray	#6 (M3) Screw	—	—	25	250

Adhesive Backed Cord Clips

- Cables are easily snapped into or out of the clips

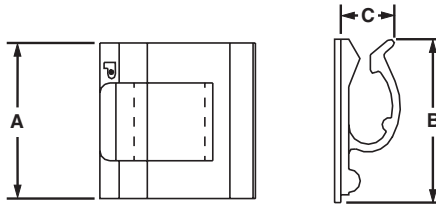

Part Number	Max. Bundle Diameter		Length A		Width B		Height C		Material	Color	Adhesive Type	Max. Static Load		Std. Pkg. Qty.	Std. Ctn. Qty.
	In.	mm	In.	mm	In.	mm	In.	mm				Lbs.	g		
ACC19-A-C	.19	4.8	.75	19.0	.62	16.0	.25	6.5	Nylon 6.6	Natural	Rubber	.20	91	100	500
ACC19-AT-C	.19	4.8	.75	19.0	.62	16.0	.26	6.6		Natural	Acrylic	.20	91	100	500
ACC19-A-C20	.19	4.8	.75	19.0	.62	16.0	.27	6.7		Black	Rubber	.20	91	100	500
ACC19-AT-C0	.19	4.8	.75	19.0	.62	16.0	.28	6.8	Weather Resistant Nylon 6.6	Black	Acrylic	.20	91	100	500
ACC38-A-C	.38	9.6	1.00	25.4	1.00	25.4	.27	6.9	Nylon 6.6	Natural	Rubber	.50	227	100	500
ACC38-AT-C	.38	9.6	1.00	25.4	1.00	25.4	.28	6.10		Natural	Acrylic	.50	227	100	500
ACC38-A-C20	.38	9.6	1.00	25.4	1.00	25.4	.29	6.9		Black	Rubber	.50	227	100	500
ACC38-AT-C0	.38	9.6	1.00	25.4	1.00	25.4	.30	6.12	Weather Resistant Nylon 6.6	Black	Acrylic	.50	227	100	500
ACC62-A-C	.62	15.7	1.24	31.4	1.12	28.5	.63	16.0	Nylon 6.6	Natural	Rubber	.70	318	100	500
ACC62-AT-C	.62	15.7	1.24	31.4	1.12	28.5	.63	.63		Natural	Acrylic	.70	318	100	500
ACC62-A-C20	.62	15.7	1.24	31.4	1.12	28.5	.63	16.0		Black	Rubber	.70	318	100	500
ACC62-AT-C0	.62	15.7	1.24	31.4	1.12	28.5	.63	16.0	Weather Resistant Nylon 6.6	Black	Acrylic	.70	318	100	500

Push Mount Cord Clip

- Cables are easily snapped into or out of clips
- Winged design holds mount in place even in applications where vibration is present
- Design of wing provides added stability

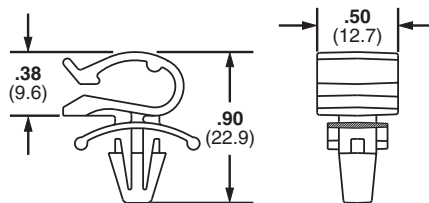
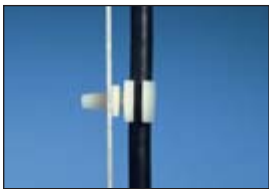

Part Number	Max. Bundle Diameter		Max. Panel Thickness		Panel Hole Diameter		Material	Color	Environment	Mounting Method	Std. Pkg. Qty.	Std. Ctn. Qty.
	In.	mm	In.	mm	In.	mm						
PMCC38H25-C	.38	9.6	.105	2.7	.250	6.4	Nylon 6.6	Natural	Indoors	Push	100	1000
PMCC38H25-M0	.38	9.6	.105	2.7	.250	6.4	Weather Resistant Nylon 6.6	Black	Outdoors	Barb	1000	5000

A. System Overview

B1. Cable Ties

B2. Cable Accessories

B3. Stainless Steel Ties

C1. Wiring Duct

C2. Surface Raceway

C3. Abrasion Protection

C4. Cable Management

D1. Terminals

D2. Power Connectors

D3. Grounding Connectors

E1. Labeling Systems

E2. Labels

E3. Pre-Printed & Write-On Markers

E4. Permanent Identification

E5. Lockout/Tagout & Safety Solutions

F. Index

A. System Overview

"J" Clips

B1. Cable Ties

- Low profile clips retain cords, cables, or tubing
- Flexible design allows for easy cord insertion, yet holds bundle tightly

- For indoor use only
- Material: PVC

B2. Cable Accessories

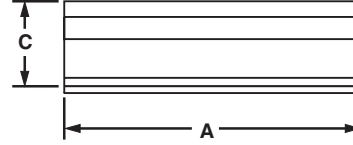
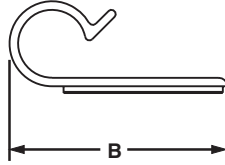
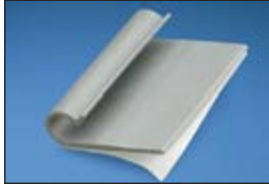

B3. Stainless Steel Ties

C1. Wiring Duct

C2. Surface Raceway

C3. Abrasion Protection

C4. Cable Management

Part Number	Max. Bundle Diameter		Length A		Width B		Height C		Diameter		Color	Adhesive Type	Max. Static Load		Std. Pkg. Qty.	Std. Ctn. Qty.
	In.	mm	In.	mm	In.	mm	In.	mm	In.	mm			Lbs.	g		
AJC12-A-C	.12	3.0	1.00	25.4	.86	21.8	.19	4.8	.13	3.3	Light Gray	Rubber	.40	182	100	1000
AJC19-A-C	.19	4.8	1.25	31.8	.87	22.1	.26	6.6	.18	4.6			.50	227	100	1000
AJC25-A-C	.25	6.4	1.50	38.1	.97	24.6	.31	7.9	.23	5.8			.60	272	100	1000
AJC31-A-C	.31	7.9	1.75	44.5	1.22	30.1	.40	10.2	.29	7.4			.90	408	100	1000
AJC38-A-C	.38	9.6	2.00	50.8	1.27	32.3	.50	12.7	.39	9.9			1.00	454	100	1000

C4. Cable Management

A1C Type Clips

D1. Terminals

- Hold cords, cables, and tubing
- Single rubber adhesive pad for confined areas

- For indoor use only
- Material: PVC

D2. Power Connectors

D3. Grounding Connectors

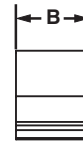
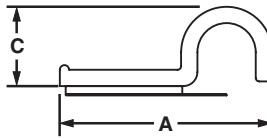
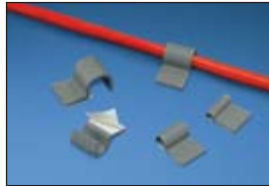

E1. Labeling Systems

E2. Labels

E3. Pre-Printed & Write-On Markers

E4. Permanent Identification

E5. Lockout/Tagout & Safety Solutions

F. Index

Part Number	Max. Bundle Diameter		Length A		Width B		Height C		Color	Adhesive Type	Max. Static Load		Std. Pkg. Qty.	Std. Ctn. Qty.
	In.	mm	In.	mm	In.	mm	In.	mm			Lbs.	g		
A1C12-A-C8	.12	3.0	.77	19.6	.63	16.0	.23	5.8	Light Gray	Rubber	.14	169	100	1000
A1C25-A-C8	.25	6.4	.91	23.1	.63	16.0	.38	9.7			.14	169	100	1000
A1C38-A-C8	.38	9.5	1.04	26.4	.63	16.0	.51	13.0			.14	169	100	1000
A1C50-A-C8	.50	12.7	1.17	29.7	.63	16.0	.64	16.3			.14	169	100	1000

A2C Type Clips

- Hold cords, cables, and tubing
- Two rubber adhesive pads for added strength

- For indoor use only
- Material: PVC

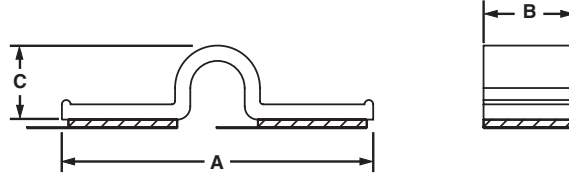

Part Number	Max. Bundle Dia.		Length A		Width B		Height C		Color	Adhesive Type	Max. Static Load		Std. Pkg. Qty.	Std. Ctn. Qty.
	In.	mm	In.	mm	In.	mm	In.	mm			Lbs.	g		
A2C12-A-C8	.12	3.0	1.30	33.0	.63	16.0	.23	5.8	Light Gray	Rubber	.14	64	100	1000
A2C25-A-C8	.25	6.4	1.43	36.3	.63	16.0	.36	9.1			.14	64	100	1000
A2C38-A-C8	.38	9.5	1.56	39.6	.63	16.0	.49	12.4			.14	64	100	1000
A2C50-A-C8	.50	12.7	1.72	43.7	.63	16.0	.61	15.5			.14	64	100	1000

Metal Adhesive Backed Cord Clips

- Can be opened and closed without damaging clip in order to remove or add cables quickly and easily

- Indoor use only

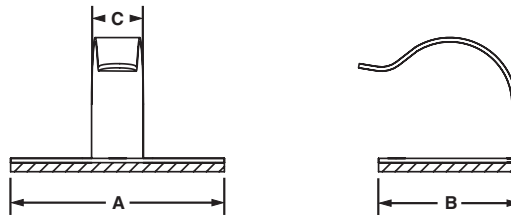

Part Number	Max. Bundle Diameter		Length A		Width B		Clip Width C		Material	Adhesive Type	Max. Static Load		Std. Pkg. Qty.	Std. Ctn. Qty.
	In.	mm	In.	mm	In.	mm	In.	mm			Lbs.	g		
MACC25-A-C	.25	6.4	.77	19.6	.54	13.7	.29	7.4	Zinc Plated Steel	Rubber	.21	95	100	1000
MACC62-A-C	.62	15.7	1.18	30.0	.78	19.7	.29	7.0			.44	200	100	1000

A. System Overview

B1. Cable Ties

B2. Cable Accessories

B3. Stainless Steel Ties

C1. Wiring Duct

C2. Surface Raceway

C3. Abrasion Protection

C4. Cable Management

D1. Terminals

D2. Power Connectors

D3. Grounding Connectors

E1. Labeling Systems

E2. Labels

E3. Pre-Printed & Write-On Markers

E4. Permanent Identification

E5. Lockout/Tagout & Safety Solutions

F. Index

A. System Overview

Latching Wire Clips

- Route and secure cords and cables
- Convenient releasable latch
- Available in six sizes with releasable latch

- Push barb parts are for use with a max panel thickness of .11 inches (2.7mm) and a hole diameter of .22 inches (5.6mm)
- For indoor use only
- Material: Nylon 6.6

B1. Cable Ties

B2. Cable Accessories

B3. Stainless Steel Ties

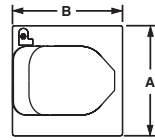
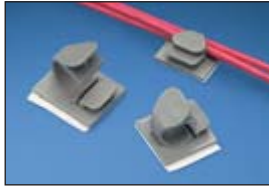

LWC**-A

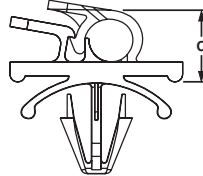
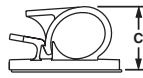

LWC**-H25

C1. Wiring Duct

C2. Surface Raceway

C3. Abrasion Protection

C4. Cable Management

D1. Terminals

D2. Power Connectors

D3. Grounding Connectors

E1. Labeling Systems

E2. Labels

E3. Pre-Printed & Write-On Markers

E4. Permanent Identification

E5. Lockout/Tagout & Safety Solutions

F. Index

Part Number	Max. Bundle Diameter		Length A		Width B		Height C		Color	Mounting Method	Max. Static Load		Std. Pkg. Qty.	Std. Ctn. Qty.
	In.	mm	In.	mm	In.	mm	In.	mm			Lbs.	g		
Adhesive Backed Products														
LWC19-A-C	.19	4.8	.85	21.6	.61	15.5	.39	9.9	Natural	Rubber Adhesive	.25	113	100	1000
LWC19-A-C14	.19	4.8	.85	21.6	.61	15.5	.39	9.9	Gray		.25	113	100	1000
LWC19-A-C20	.19	4.8	.85	21.6	.61	15.5	.39	9.9	Black		.25	113	100	1000
LWC25-A-C	.25	6.4	.88	22.2	1.00	25.4	.45	11.4	Natural		.45	204	100	1000
LWC25-A-C14	.25	6.4	.88	22.2	1.00	25.4	.45	11.4	Gray		.45	204	100	1000
LWC25-A-C20	.25	6.4	.88	22.2	1.00	25.4	.45	11.4	Black		.45	204	100	1000
LWC38-A-C	.37	9.5	1.00	25.4	1.00	25.4	.56	14.2	Natural		.50	227	100	1000
LWC38-A-C14	.37	9.5	1.00	25.4	1.00	25.4	.56	14.2	Gray		.50	227	100	1000
LWC38-A-C20	.37	9.5	1.00	25.4	1.00	25.4	.56	14.2	Black		.50	227	100	1000
LWC50-A-L	.50	12.7	1.26	32.0	1.00	25.4	.67	17.0	Natural		.63	284	50	500
LWC50-A-L14	.50	12.7	1.26	32.0	1.00	25.4	.67	17.0	Gray		.63	284	50	500
LWC50-A-L20	.50	12.7	1.26	32.0	1.00	25.4	.67	17.0	Black		.63	284	50	500
LWC75-A-L	.75	19.1	1.48	37.6	1.24	31.5	.90	22.9	Natural		.93	417	50	500
LWC75-A-L14	.75	19.1	1.48	37.6	1.24	31.5	.90	22.9	Gray		.93	417	50	500
LWC75-A-L20	.75	19.1	1.48	37.6	1.24	31.5	.90	22.9	Black		.93	417	50	500
LWC100-A-L	1.00	25.4	2.21	56.1	1.97	50.0	1.26	32.0	Natural		2.25	1020	50	500
LWC100-A-L14	1.00	25.4	2.21	56.1	1.97	50.0	1.26	32.0	Gray	2.25	1020	50	500	
LWC100-A-L20	1.00	25.4	2.21	56.1	1.97	50.0	1.26	32.0	Black	2.25	1020	50	500	

Push Mount Products														
LWC19-H25-C	.19	4.8	.85	21.6	.51	12.8	.41	10.4	Natural	Push Barb	—	—	100	1000
LWC19-H25-C14	.19	4.8	.85	21.6	.51	12.8	.41	10.4	Gray		—	—	100	1000
LWC25-H25-C	.25	6.4	.86	21.8	.58	14.7	.47	11.9	Natural		—	—	100	1000
LWC25-H25-C14	.25	6.4	.86	21.8	.58	14.7	.47	11.9	Gray		—	—	100	1000
LWC25-H25-C20	.25	6.4	.86	21.8	.58	14.7	.47	11.9	Black		—	—	100	1000
LWC38-H25-C	.37	9.5	.94	23.9	.58	14.7	.57	14.5	Natural		—	—	100	1000
LWC38-H25-C14	.37	9.5	.94	23.9	.58	14.7	.57	14.5	Gray		—	—	100	1000
LWC38-H25-C20	.37	9.5	.94	23.9	.58	14.7	.57	14.5	Black		—	—	100	1000
LWC50-H25-L	.50	12.7	1.25	31.8	.76	19.3	.78	19.8	Natural		—	—	50	500
LWC50-H25-L14	.50	12.7	1.25	31.8	.76	19.3	.78	19.8	Gray		—	—	50	500
LWC50-H25-L20	.50	12.7	1.25	31.8	.76	19.3	.78	19.8	Black		—	—	50	500
LWC75-H25-L	.75	19.1	1.45	36.8	.87	22.1	.97	24.7	Natural		—	—	50	500
LWC75-H25-L14	.75	19.1	1.45	36.8	.87	22.1	.97	24.7	Gray		—	—	50	500
LWC75-H25-L20	.75	19.1	1.45	36.8	.87	22.1	.97	24.7	Black		—	—	50	500
LWC100-H25-L	1.00	25.4	1.89	47.9	1.00	25.4	1.30	33.0	Natural		—	—	50	500
LWC100-H25-L14	1.00	25.4	1.89	47.9	1.00	25.4	1.30	33.0	Gray		—	—	50	500
LWC100-H25-L20	1.00	25.4	1.89	47.9	1.00	25.4	1.30	33.0	Black		—	—	50	500

Bevel Entry Clips

- Beveled entry allows for easy insertion of cable bundle

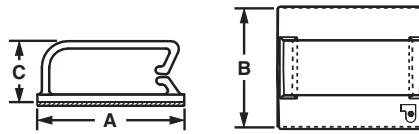

BEC

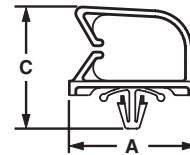

BECP

Part Number	Max. Bundle Diameter		Length A		Width B		Height C		Material	Color	Environment	Mounting Method	Max. Static Load		Std. Pkg. Qty.	Std. Ctn. Qty.
	In.	mm	In.	mm	In.	mm	In.	mm					Lbs.	g		
Adhesive Backed																
BEC38-A-L	.38	9.6	1.46	37.1	1.24	31.5	.52	13.2	Nylon 6.6	Natural	Indoors	Rubber	.91	411	50	500
BEC38-A-L20	.38	9.6	1.46	37.1	1.24	31.5	.52	13.2		Black		Rubber	.91	411	50	500
BEC38-AT-L0	.38	9.6	1.46	37.1	1.24	31.5	.52	13.2	Weather Resistant Nylon 6.6	Black	Outdoors	Acrylic	.91	411	50	500
BEC62-A-L	.62	15.7	1.46	37.1	1.24	31.5	.79	20.1	Nylon 6.6	Natural	Indoors	Rubber	.91	411	50	500
BEC62-A-L20	.62	15.7	1.46	37.1	1.24	31.5	.79	20.1		Black		Rubber	.91	411	50	500
BEC62-AT-L0	.62	15.7	1.46	37.1	1.24	31.5	.79	20.1	Weather Resistant Nylon 6.6	Black	Outdoors	Acrylic	.91	411	50	500
BEC75-A-L	.75	19.0	1.46	37.1	1.49	37.8	.89	22.6	Nylon 6.6	Natural	Indoors	Rubber	1.09	493	50	500
BEC75-A-L20	.75	19.0	1.46	37.1	1.49	37.8	.89	22.6		Black		Rubber	1.09	493	50	500
BEC75-AT-L0	.75	19.0	1.46	37.1	1.49	37.8	.89	22.6	Weather Resistant Nylon 6.6	Black	Outdoors	Acrylic Adhesive	1.09	493	50	500
Push Barb																
BECP38H25-L	.38	9.6	1.46	37.1	.73	18.5	1.00	25.4	Nylon 6.6	Natural	Indoors	Push Barb	—	—	50	500
BECP38H25-L20	.38	9.6	1.46	37.1	.73	18.5	1.00	25.4		Black			—	—	50	500
BECP75H25-L	.75	19.0	1.47	37.3	.73	18.5	1.35	34.3		Natural			—	—	50	500
BECP75H25-L20	.75	19.0	1.47	37.3	.73	18.5	1.35	34.3		Black			—	—	50	500

*For proper selection of adhesive see page B2.52.

A. System Overview

B1. Cable Ties

B2. Cable Accessories

B3. Stainless Steel Ties

C1. Wiring Duct

C2. Surface Raceway

C3. Abrasion Protection

C4. Cable Management

D1. Terminals

D2. Power Connectors

D3. Grounding Connectors

E1. Labeling Systems

E2. Labels

E3. Pre-Printed & Write-On Markers

E4. Permanent Identification

E5. Lockout/Tagout & Safety Solutions

F. Index

A. System Overview

Adhesive Backed Dual Cord Clip

- Holds two cables in high temperature applications

B1. Cable Ties

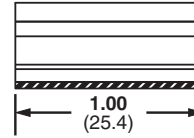
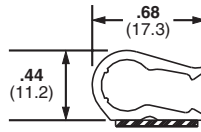
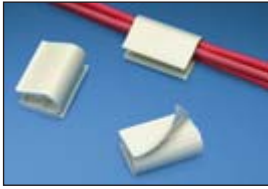

B2. Cable Accessories

B3. Stainless Steel Ties

Part Number	Max. Bundle Diameter		Material	Color	Environment	Adhesive Type	Max. Static Load		Std. Pkg. Qty.	Std. Ctn. Qty.
	In.	mm					Lbs.	g		
ADCC31-AT-C10	.33	9.0	NORYL*	White	Indoors	Acrylic	.25	113	100	500

*NORYL Thermoplastic Resin is a registered trademark of General Electric Company.

C1. Wiring Duct

C2. Surface Raceway

Adhesive Backed Mount Cord Clip

- Holds a single cable
- Funnel entry speeds cable insertion
- Vertical cable entry for ease of installation

C3. Abrasion Protection

C4. Cable Management

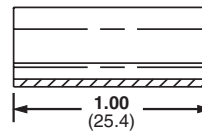
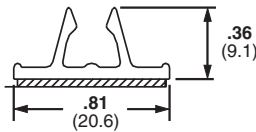

D1. Terminals

D2. Power Connectors

Part Number	Max. Bundle Diameter		Material	Color	Environment	Adhesive Type	Max. Static Load		Std. Pkg. Qty.	Std. Ctn. Qty.
	In.	mm					Lbs.	g		
AMC25-AT-C10	.22 – .28	6.0 – 7.0	PVC	White	Indoors	Acrylic	.40	182	100	1000

D3. Grounding Connectors

E1. Labeling Systems

Vertical Cord Clips

- Funnel entry design allows for easy insertion of cords and cables
- For indoor use only
- Vertical cable entry for ease of installation

E2. Labels

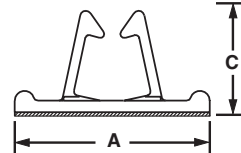
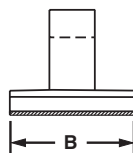
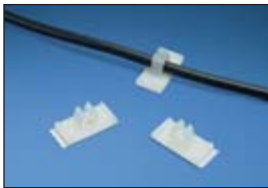

E3. Pre-Printed & Write-On Markers

E4. Permanent Identification

Part Number	Max. Bundle Diameter		Length A		Width B		Height C		Material	Color	Adhesive Type	Max. Static Load		Std. Pkg. Qty.	Std. Ctn. Qty.
	In.	mm	In.	mm	In.	mm	In.	mm				Lbs.	g		
VCC25-A-C	.25	6.4	1.00	25.4	.50	12.7	.44	11.2	Nylon 6.6	Natural	Rubber	.25	113	100	500
VCC50-A-C	.50	12.7	1.56	39.7	1.00	25.4	.81	20.6				.78	339	100	500

E5. Lockout/Tagout & Safety Solutions

F. Index

Adhesive Backed Latching Clips

- Latching cover withstands vibration

- For indoor use only

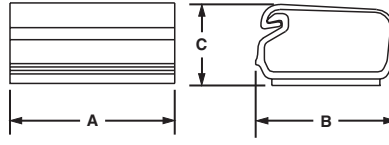

Part Number	Max. Bundle Diameter		Length A		Width B		Height C		Material	Color	Adhesive Type	Max. Static Load		Std. Pkg. Qty.	Std. Ctn. Qty.
	In.	mm	In.	mm	In.	mm	In.	mm				Lbs.	g		
LC3-A-C8	.20	5.0	.75	19.1	.75	19.0	.47	11.9	PVC	Light Gray	Rubber	.22	100	100	1000
LC5-A-C8	.36	9.1	1.01	25.7	1.01	25.7	.61	15.5				.44	200	100	1000
LC10-A-L8	.93	23.6	1.51	38.4	1.51	38.4	.84	21.3				.60	272	50	500

Cable Holder – Adhesive Backed

- Convenient releasable latch allows easy addition and removal of cables

- Low profile design provides a compact cable routing solution
- For indoor use only

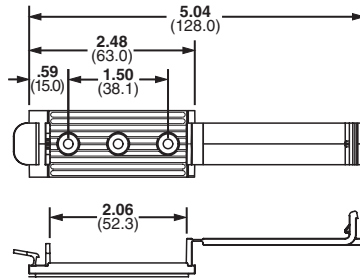

Part Number	Cable Width		Material	Color	Mounting Method	Max. Static Load		Std. Pkg. Qty.	Std. Ctn. Qty.
	In.	mm				Lbs.	g		
CH105-A-C14	2.06	52.3	Nylon 6.6	Gray	Rubber Adhesive	1.28	581	100	1000
CH105-S6-C14	2.06	52.3			#6 (M3) screw	—	—	100	1000

Low Profile Flat Cable Mounts

- Three sizes provide a cost effective flat cable containment for stack heights up to .105 inches (2.7mm)
- Features a matte, textured surface, for either hand written identification or application of computer labels

- Low profile design holds wires, cables, and tubing
- For indoor use only

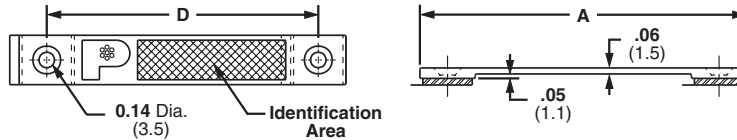
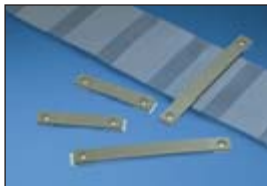

Part Number	Cable Width		Length A		Hole Spacing D		Material	Color	Adhesive Type	Std. Pkg. Qty.	Std. Ctn. Qty.
	In.	mm	In.	mm	In.	mm					
LPFCM14-A-C14	1.44	37.0	2.56	65.0	2.00	50.8	Nylon 6.6	Gray	Rubber	100	500
LPFCM22-A-C14	2.19	56.0	3.31	84.0	2.75	69.9				100	500
LPFCM34-A-C14	3.44	87.0	4.56	115.8	4.00	101.6				100	500

A. System Overview

Latching Flat Cable Mounts

B1. Cable Ties

- Available in four sizes with a stack height of .17 inches (4.3mm) to accommodate different flat cable widths
- Low profile design holds wires, cables, and tubing
- Convenient releasable latch
- Large mounting base for high bonding strength
- For indoor use only
- Material: Nylon 6.6

B2. Cable Accessories



B3. Stainless Steel Ties

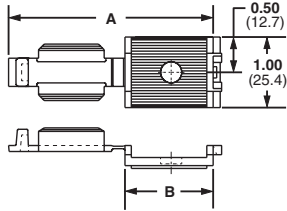

FCM1 and FCM1.2

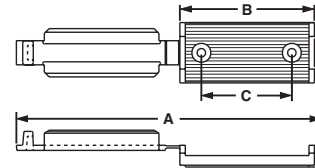

FCM2 and FCM3.25

C1. Wiring Duct

C2. Surface Raceway

C3. Abrasion Protection

C4. Cable Management

D1. Terminals

D2. Power Connectors

D3. Grounding Connectors

E1. Labeling Systems

E2. Labels

E3. Pre-Printed & Write-On Markers

E4. Permanent Identification

E5. Lockout/Tagout & Safety Solutions

F. Index

Part Number	Cable Width		Length A		Width B		Hole Spacing C		Color	Mounting Method	Std. Pkg. Qty.	Std. Ctn. Qty.
	In.	mm	In.	mm	In.	mm	In.	mm				
Adhesive Backed												
FCM1-A-C14	1.05	26.7	2.90	73.7	1.05	26.7	—	—	Gray	Rubber Adhesive	100	500
FCM1.2-A-C14	1.20	30.5	3.16	80.3	1.37	34.8	—	—			100	1000
FCM2-A-C14	2.05	52.1	5.06	128.5	2.22	56.4	1.53	38.9			100	500
FCM3.25-A-L14	3.38	85.9	7.30	185.4	3.38	85.9	1.50	38.1			50	500
Screw Mounted												
FCM1-S6-C14	1.05	26.7	2.90	73.7	1.00	25.4	—	—	Gray	#6 (M3) Screw	100	1000
FCM1.2-S6-C14	1.20	30.5	3.16	80.3	1.37	34.8	—	—			100	1000
FCM2-S6-C14	2.05	52.1	5.06	128.5	2.22	56.4	1.53	38.9			100	1000
FCM3.25-S6-L14	3.38	85.9	7.30	185.4	3.38	85.9	1.50	38.1			50	500

Latching Flat Cable Holders

- Designed for flat cable up to a cable stack height of .25 inches (6.4mm) or discrete wire
- Low profile design holds wires, cables, and tubing
- Convenient releasable latch
- Large mounting base for high bonding strength
- For indoor use only

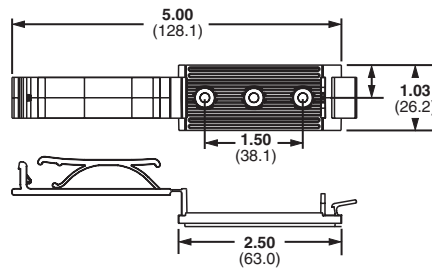

Part Number	Length		Cable Width		Color	Mounting Method	Std. Pkg. Qty.	Std. Ctn. Qty.
	In.	mm	In.	mm				
FCH2-A-C14	2.48	63.0	2.00	50.8	Gray	Rubber Adhesive	100	500
FCH2-S6-C14	2.48	63.0	2.00	50.8	Gray	#6 (M3) Screw	100	500

Flat Cable Clips

- Use with any width flat cable for a maximum stack height of .17 inches (4.3mm)
- Low profile design holds wires, cables, and tubing
- For indoor use only
- Material: PVC

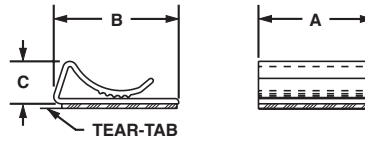
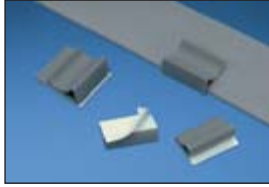

Part Number	Cable Width	Length A		Width B		Height C		Color	Mounting Method	Std. Pkg. Qty.	Std. Ctn. Qty.
		In.	mm	In.	mm	In.	mm				
FCC5-A-C8	Any width flat cable	1.00	25.4	.56	14.2	.29	7.4	Gray	Rubber	100	1000
FCC-A-C8		1.00	25.4	1.09	27.7	.38	9.7			100	1000

PAN-CLAMP™ Heavy Duty Fixed Diameter Clamps

- One-piece design significantly reduces installation time
- Integrated ribs prevent rotation of cable bundles and ensures secure grip on hoses
- Material: Impact modified Weather Resistant Nylon 6.6

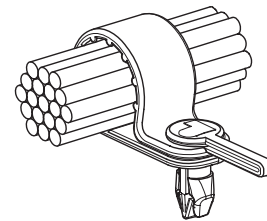
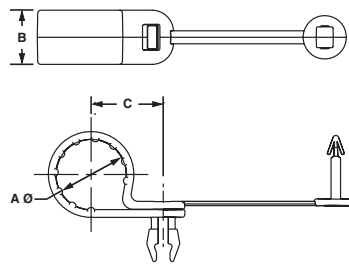

Part Number	Max. Bundle Diameter A		Width B		Bundle Offset C		Max. Panel Thickness		Panel Hole Diameter		Color	Std. Pkg. Qty.	Std. Ctn. Qty.
	In.	mm	In.	mm	In.	mm	In.	mm	In.	mm			
PC038-H25D-C0	.38	9.5	.62	15.7	.64	16.3	.13	3.2	.28	7.1	Black	100	500
PC050-H25D-C0	.50	12.7	.62	15.7	.71	17.9	.13	3.2	.28	7.1		100	500
PC062-H25D-C0	.63	15.8	.62	15.7	.77	19.5	.13	3.2	.28	7.1		100	500
PC075-H25D-C0	.75	19.1	.62	15.7	.83	21.1	.13	3.2	.28	7.1		100	1000
PC087-H25D-C0	.88	22.1	.62	15.7	.89	22.7	.13	3.2	.28	7.1		100	1000
PC100-H25D-C0	1.00	25.4	.62	15.7	.96	24.3	.13	3.2	.28	7.1		100	1000
PC112-H25D-C0	1.13	28.5	.62	15.7	1.02	25.8	.13	3.2	.28	7.1		100	1000
PC125-H25D-C0	1.25	31.8	.62	15.7	1.08	27.4	.13	3.2	.28	7.1		100	1000

A.
System
Overview

Fixed Diameter Cable Clamps

- Durable Nylon 6.6 cable clamps

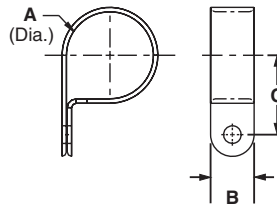

B1.
Cable Ties

B2.
Cable
Accessories

B3.
Stainless
Steel Ties

C1.
Wiring
Duct

C2.
Surface
Raceway

C3.
Abrasion
Protection

C4.
Cable
Management

D1.
Terminals

D2.
Power
Connectors

D3.
Grounding
Connectors

E1.
Labeling
Systems

E2.
Labels

E3.
Pre-Printed
& Write-On
Markers

E4.
Permanent
Identification

E5.
Lockout/
Tagout/
& Safety
Solutions

F.
Index

Part Number	Max. Bundle Diameter A		Width B		Bundle Offset C		Mounting Method	Std. Pkg. Qty.	Std. Ctn. Qty.
	In.	mm	In.	mm	In.	mm			
CCS12-S8-C	.12	3.1	.37	9.4	.33	8.4	#8 (M4) Screw	100	500
CCS19-S8-C	.19	4.8	.37	9.4	.43	10.9	#8 (M4) Screw	100	500
CCS25-S8-C	.25	6.3	.37	9.4	.41	10.4	#8 (M4) Screw	100	500
CCS25-S10-C	.25	6.3	.37	9.4	.41	10.4	#10 (M5) Screw	100	500
CCS31-S8-C	.31	7.9	.37	9.4	.49	12.4	#8 (M4) Screw	100	500
CCS38-S8-C	.38	9.5	.37	9.4	.59	15.0		100	500
CCS44-S8-C	.44	11.1	.37	9.4	.57	14.5		100	500
CCS50-S8-C	.50	12.7	.37	9.4	.60	15.2		100	500
CCH12-S10-C	.12	3.1	.50	12.7	.36	9.1	#10 (M5) Screw	100	500
CCH19-S10-C	.19	4.8	.50	12.7	.42	10.7		100	500
CCH25-S10-C	.25	6.3	.50	12.7	.46	11.7		100	500
CCH31-S10-C	.31	7.9	.50	12.7	.50	12.7		100	500
CCH38-S10-C	.38	9.5	.50	12.7	.53	13.5		100	500
CCH44-S10-C	.44	11.1	.50	12.7	.56	14.2		100	500
CCH50-S10-C	.50	12.7	.50	12.7	.59	15.0		100	500
CCH56-S10-C	.56	14.2	.50	12.7	.61	15.5		100	500
CCH62-S10-C	.62	15.7	.50	12.7	.65	16.5		100	500
CCH69-S10-C	.69	17.5	.50	12.7	.75	19.1		100	500
CCH75-S10-C	.75	19.1	.50	12.7	.78	19.8		100	500
CCH81-S10-C	.81	20.6	.50	12.7	.81	20.6		100	500
CCH87-S10-C	.87	22.1	.50	12.7	.84	21.3		100	500
CCH100-S10-C	1.00	25.4	.50	12.7	.91	23.1		100	500
CCH112-S10-C	1.12	28.4	.50	12.7	.97	24.6	100	500	
CCH119-S10-C	1.19	30.2	.50	12.7	1.00	25.4	100	500	
CCH125-S10-C	1.25	31.8	.50	12.7	1.06	26.9	100	500	
CCH138-S10-C	1.37	34.8	.50	12.7	1.12	28.4	100	500	
CCH150-S10-C	1.50	38.1	.50	12.7	1.19	30.2	100	500	

All parts listed are also available in black weather resistant material (add suffix 0). Bulk package only.

Wire Retainers

- Wires slide into the clip and are held in place by tension
- Low profile design holds wires, cables, and tubing
- Funnel entry design allows for easy insertion of cords and cables

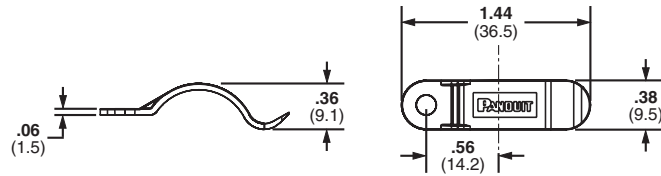

Part Number	Max. Bundle Diameter		Material	Color	Environment	Mounting Method	Std. Pkg. Qty.	Std. Ctn. Qty.
	In.	mm						
TWR-C	.38	9.5	Nylon 6.6	Natural	Indoors	#6 (M3) Screw	100	500
TWR-C0	.38	9.5	Weather Resistant Nylon 6.6	Black	Outdoors		100	500

Tack Clips

- Clips secure cords, cables, and tubing
- Suitable for outdoor use
- Hardened steel nail securely mounts to wooden surfaces
- Material: Weather Resistant Polypropylene

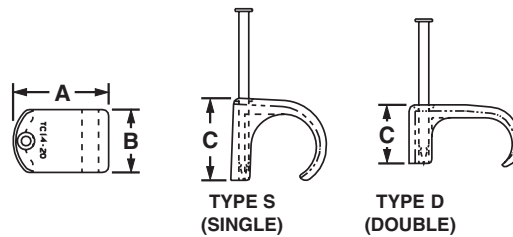

Part Number	Type	Max. Bundle Diameter		Length A		Width B		Height C		Coaxial Cross RG#	Color	Std. Pkg. Qty.	Std. Ctn. Qty.
		In.	mm	In.	mm	In.	mm	In.	mm				
TC3-5-C100	Single	.13	3.3	.29	7.4	.23	5.8	.20	5.1	187	Black	100	1000
TC5-7-C100	Single	.21	5.3	.39	9.9	.23	5.8	.31	7.9	58		100	1000
TC7-10-C100	Single	.27	6.9	.49	12.5	.35	8.9	.38	9.7	59		100	1000
TC10-14-C100	Single	.35	8.9	.59	14.9	.45	11.4	.51	13	6A		100	1000
TC14-20-C100	Single	.52	13.2	.79	20.6	.54	13.7	.67	17	8A, 9B, 11		100	1000
TC5X8-C100	Double	.20 x .31	5.0 x 7.9	.54	13.7	.27	6.8	.30	8.8	—		100	1000
TC6X10-C100	Double	.23 x .38	6.0 x 9.7	.62	15.7	.34	8.6	.34	8.6	—		100	1000
TC7X14-C100	Double	.25 x .46	6.4 x 12	.70	17.8	.43	10.9	.36	9.1	—		100	1000
TC9X18-C100	Double	.37 x .65	9.4 x 17	.89	22.6	.52	13.2	.50	12.7	—		100	1000

A. System Overview

Siding Clips

- Low profile installs without drilling or nailing
- Attach coax cable to buildings having "Pittsburgh Interlok" type aluminum or steel siding
- Will not corrode or stain siding

B1. Cable Ties

B2. Cable Accessories

B3. Stainless Steel Ties

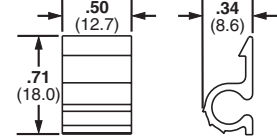
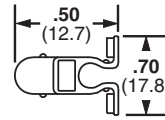
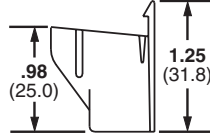
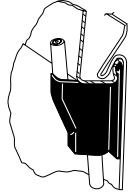
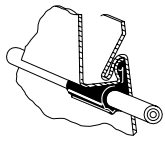

Horizontal Siding Clip

Vertical Siding Clip

VSC Vertical Clip

HSC Horizontal Clip

C1. Wiring Duct

C2. Surface Raceway

C3. Abrasion Protection

Part Number	Max. Bundle Diameter		Material	Color	Mounting Method	Std. Pkg. Qty.	Std. Ctn. Qty.
	In.	mm					
HSC.25-L	.25	6.4	Nylon 6.6	White	Clip	50	500
HSC.25-L100	.25	6.4	Weather Resistant Polypropylene	Black		50	500
VSC.25-L	.25	6.4	Nylon 6.6	White		50	500
VSC.25-L100	.25	6.4	Weather Resistant Polypropylene	Black		50	500

C4. Cable Management

Wire Standoffs

- For retaining wires, cable, components or tubing away from panel or conductive chassis
- Design of wing provides added stability
- Material: Nylon 6.6
- Finger grip flanges can be easily locked or unlocked for revisions
- Indoor use only

D1. Terminals

D2. Power Connectors

D3. Grounding Connectors

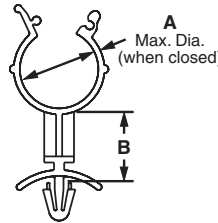

E1. Labeling Systems

E2. Labels

E3. Pre-Printed & Write-On Markers

E4. Permanent Identification

E5. Lockout/Tagout & Safety Solutions

F. Index

Part Number	Max. Bundle Diameter A		Standoff Height B		Max. Panel Thickness		Panel Hole Diameter		Color	Mounting Method	Std. Pkg. Qty.	Std. Ctn. Qty.
	In.	mm	In.	mm	In.	mm	In.	mm				
WS25-25-C	.25	6.4	.25	6.4	.08	2.0	.19	4.7	Natural	Push Barb	100	500
WS25-50-C	.25	6.4	.50	12.7	.08	2.0	.19	4.7			100	500
WS25-75-C	.25	6.4	.75	19.1	.08	2.0	.19	4.7			100	500
WS35-25-C	.35	8.9	.25	6.4	.08	2.0	.19	4.7			100	500
WS35-50-C	.35	8.9	.50	12.7	.08	2.0	.19	4.7			100	500
WS35-75-C	.35	8.9	.75	19.1	.08	2.0	.19	4.7			100	500
WS50-25-C	.47	11.9	.25	6.4	.08	2.0	.19	4.7			100	500
WS50-50-C	.47	11.9	.50	12.7	.08	2.0	.19	4.7			100	500
WS50-75-C	.47	11.9	.75	19.1	.08	2.0	.19	4.7			100	500
WS75-25-C	.78	19.8	.25	6.4	.08	2.0	.19	4.7			100	500
WS75-50-C	.78	19.8	.50	12.7	.08	2.0	.19	4.7			100	500
WS75-75-C	.78	19.8	.75	19.1	.08	2.0	.19	4.7			100	500

Snap-In Clips

- Clip around bundle to hold securely in place
- Clips are placed on the bundle then attached to the panel

- Material: Nylon 6.6
- Indoor use only

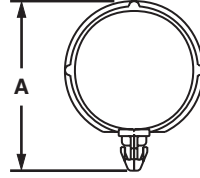

Part Number	Max. Bundle Diameter		Height A		Max. Panel Thickness		Panel Hole Diameter		Color	Mounting Method	Std. Pkg. Qty.	Std. Ctn. Qty.
	In.	mm	In.	mm	In.	mm	In.	mm				
SICH25-C	.25	6.4	.40	20.9	.10	2.5	.25	6.4	Natural	Push Barb	100	500
SICH38-C	.38	9.7	.54	24.9	.10	2.5	.25	6.4			100	500
SICH50-C	.50	12.7	.67	28.2	.10	2.5	.25	6.4			100	500
SICH75-C	.75	19.1	.96	35.6	.10	2.5	.25	6.4			100	500
SICH100-C	1.00	25.4	1.21	41.9	.10	2.5	.25	6.4			100	500
SICH150-C	1.50	38.0	1.71	54.6	.10	2.5	.25	6.4			100	500

Wire Saddles

- Funnel entry design for fast insertion of wires and cables
- Available in vertical and horizontal loading configurations
- Design of wing provides added stability

- Material: Nylon 6.6
- Indoor use only



VWS Vertical

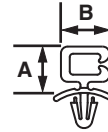

HWS Horizontal

Part Number	Max. Bundle Capacity		Height A		Width B		Max. Panel Thickness		Panel Hole Diameter		Color	Mounting Method	Std. Pkg. Qty.	Std. Ctn. Qty.
	In.	mm	In.	mm	In.	mm	In.	mm	In.	mm				
VWS4218-C	.18 x .42	5.0 x 11.0	.58	14.7	.60	15.2	.08	2.0	.19	4.7	Natural	Push Barb	100	500
VWS4238-C	.40 x .42	10.2 x 11.0	.78	19.8	.60	15.2	.08	2.0	.19	4.7			100	500
VWS4274-C	.74 x .42	19.0 x 11.0	1.14	29.0	.60	15.2	.08	2.0	.19	4.7			100	500
VWS42105-C	1.05 x .42	27.0 x 11.0	1.45	36.8	.60	15.2	.08	2.0	.19	4.7			100	1000
HWS2819-C	.19 x .28	5.0 x 11.0	.42	10.7	.44	11.2	.08	2.0	.19	4.7			100	500

A. System Overview

Optical Fiber Network Saddle

B1. Cable Ties

- Use in pre-drilled .18 inch (4.0mm) holes in panels up to .09 inches (2.0mm) thick

- Smooth rounded edges eliminate potential for snagging and stress on cable

B2. Cable Accessories



B3. Stainless Steel Ties

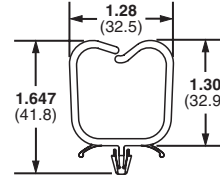
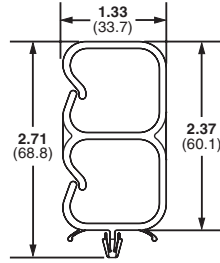

VWSDC

VWS106

Part Number	Max. Bundle Diameter		Material	Mounting Method	Color	Std. Pkg. Qty.	Std. Ctn. Qty.
	In.	mm					
VWSDC-C*	1.06	26.9	Nylon 6.6	Push Mount	Natural	100	500
VWS106-C	1.06	26.9	Nylon 6.6	Push Mount	Natural	100	500

*Accepts two bundles.

C1. Wiring Duct

C2. Surface Raceway

C3. Abrasion Protection

C4. Cable Management

D1. Terminals

Harness Clips

- Integral “spring” holds wire bundles tightly
- Available in vertical and horizontal loading configurations

- Design of wing provides added stability

D2. Power Connectors

D3. Grounding Connectors

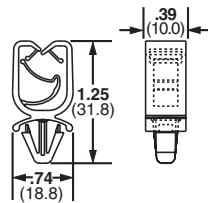

HCMP06B

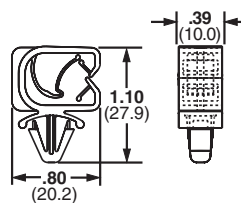

HCMP06C

E1. Labeling Systems

E2. Labels

E3. Pre-Printed & Write-On Markers

E4. Permanent Identification

E5. Lockout/Tagout & Safety Solutions

F. Index

Part Number	Max. Bundle Diameter Range		Max. Panel Thickness		Panel Hole Diameter		Material	Color	Mounting Method	Std. Pkg. Qty.	Std. Ctn. Qty.
	In.	mm	In.	mm	In.	mm					
HCMP06B12-C20	.24 – .47	5.9 – 12.5	.118	3.0	.25	6.4	Nylon 6.6	Black	Push Mount	100	500
HCMP06C12-C20	.24 – .47	5.9 – 12.5	.105	2.7	.25	6.4				100	500



Nylon Edge Clips

- Integral “spring” holds wire bundles tightly
- Available in vertical and horizontal loading configurations
- Design of wing provides added stability
- Indoor/Outdoor use

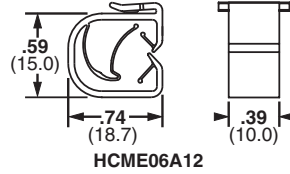

Part Number	Max. Bundle Diameter Range		Max. Panel Thickness		Material	Color	Mounting Method	Std. Pkg. Qty.	Std. Ctn. Qty.
	In.	mm	In.	mm					
HCME04Y09-C30*	.16 – .35	4.0 – 9.0	.16	4.0	Nylon 6.6 Heat Stabilized	Black	Clip-on	100	—
HCME06A12-C130	.24 – .47	5.9 – 12.5	.05	1.2	Acetal Heat Stabilized			100	500
HCME06Y12-C30*	.16 – .35	4.0 – 9.0	.16	4.0	Nylon 6.6 Heat Stabilized			100	—

*Bulk packaging size available.

Wire Bundle Strap

- Securely routes large cable bundles
- Rounded edges prevent damage to cable jackets

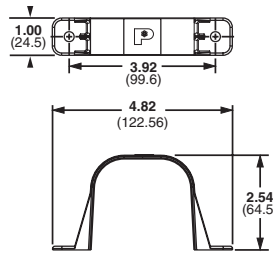

Part Number	Bundle Retaining Area In. ²	Material	Color	Mounting Method	Std. Pkg. Qty.	Std. Ctn. Qty.
WBS6-Q	6.00	ABS	White	(2) 1/4" (M6) Screws	25	125

A. System Overview

B1. Cable Ties

B2. Cable Accessories

B3. Stainless Steel Ties

C1. Wiring Duct

C2. Surface Raceway

C3. Abrasion Protection

C4. Cable Management

D1. Terminals

D2. Power Connectors

D3. Grounding Connectors

E1. Labeling Systems

E2. Labels

E3. Pre-Printed & Write-On Markers

E4. Permanent Identification

E5. Lockout/Tagout & Safety Solutions

F. Index

A.
System
Overview

Circuit Board Posts

B1.
Cable Ties

- For board-to-board or board-to-chassis mounting
- Bell flange on bottom end provides greater stability
- Releasable and reusable

- Material: Nylon 6.6
- Color: Natural

B2.
Cable
Accessories



B3.
Stainless
Steel Ties

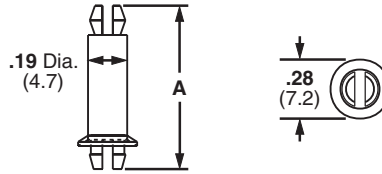

Part Number	Standoff Height		Height A		Panel Hole Diameter		Mounting Method	Std. Pkg. Qty.	Std. Ctn. Qty.
	In.	mm	In.	mm	In.	mm			
CBP12-C	.12	3.0	.40	10.2	.156	3.96	Push Barb	100	500
CBP25-C	.25	6.4	.54	13.5	.156	3.96		100	500
CBP31-C	.31	7.9	.59	15.0	.156	3.96		100	500
CBP37-C	.37	9.4	.62	15.7	.156	3.96		100	500
CBP50-C	.50	12.7	.78	19.8	.156	3.96		100	500
CBP62-C	.62	15.7	.91	23.0	.156	3.96		100	500
CBP75-C	.75	19.1	1.04	26.2	.156	3.96		100	500
CBP87-C	.87	22.1	1.15	29.2	.156	3.96		100	500
CBP100-C	1.00	25.4	1.28	32.5	.156	3.96		100	500

C1.
Wiring
Duct

C2.
Surface
Raceway

C3.
Abrasion
Protection

C4.
Cable
Management

D1.
Terminals

Circuit Board Locking Supports

- For board-to-chassis support
- Snap-in design for fast assembly
- Design of wing provides added stability

- Releasable and reusable
- Material: Nylon 6.6

D2.
Power
Connectors

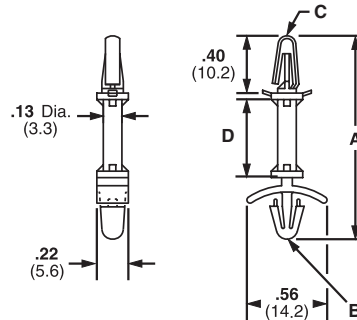

D3.
Grounding
Connectors

E1.
Labeling
Systems

E2.
Labels

E3.
Pre-Printed
& Write-On
Markers

E4.
Permanent
Identification

E5.
Lockout/
Tagout/
& Safety
Solutions

F.
Index

Part Number	Height A		Panel Hole Diameter B		Chassis Panel Hole Diameter C		Standoff Height D		Color	Mounting Method	Std. Pkg. Qty.	Std. Ctn. Qty.
	In.	mm	In.	mm	In.	mm	In.	mm				
CBLS18-C	.92	23.4	.19	4.8	.16	4.0	.19	4.7	Natural	Push Barb	100	500
CBLS25-C	.98	24.9	.19	4.8	.16	4.0	.25	6.4			100	500
CBLS37-C	1.11	28.2	.19	4.8	.16	4.0	.38	9.5			100	500
CBLS50-C	1.23	31.2	.19	4.8	.16	4.0	.50	12.7			100	500
CBLS62-C	1.35	34.3	.19	4.8	.16	4.0	.63	15.9			100	500
CBLS75-C	1.48	37.5	.19	4.8	.16	4.0	.75	19.1			100	500

Harness Board Accessories

PANDUIT harness board accessories provide fast routing and forming of wires in harness fabrication. They hold the wires off the harness board at a uniform height for easy application of cable ties. The accessories are designed for use with various PANDUIT cable tie installation tools. To maintain the harness at a uniform height of approx. 1.33 inches (33.8mm) (at the center of the harness) above the board, use RER Elastic Retainers, BR.75-E6 or BR.5-E6, CPH.75-S8, TJF and SHH1-S8 or SHH3-S8 harness board accessories. This height is suitable for use with PAT1M Automatic Cable Tie Installation Tool.



A.
System
Overview

B1.
Cable Ties

B2.
Cable
Accessories

B3.
Stainless
Steel Ties

C1.
Wiring
Duct

C2.
Surface
Raceway

C3.
Abrasion
Protection

C4.
Cable
Management

D1.
Terminals

D2.
Power
Connectors

D3.
Grounding
Connectors

E1.
Labeling
Systems

E2.
Labels

E3.
Pre-Printed
& Write-On
Markers

E4.
Permanent
Identification

E5.
Lockout/
Tagout &
Safety
Solutions

F.
Index

Elastic Retainers

- Cable bundles are formed as individual wires are inserted
- Completed bundles can be easily removed
- The elastic band is replaceable
- For indoor use only

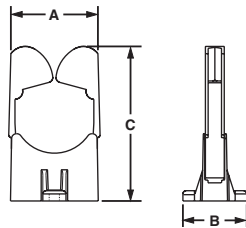

Replacement Elastic

Part Number	Pkg. Qty.
RER.5E-X	10
RER.75E-X	10
RER1.25E-X	10

For economy, the elastic band can be replaced in the RER Elastic Retainers without removing the RER base.

Part Number	Max. Bundle Diameter		Length A		Width B		Height C		Material	Color	Mounting Method	Std. Pkg. Qty.	Std. Ctn. Qty.
	In.	mm	In.	mm	In.	mm	In.	mm					
RER.5-S6-X	.50	12.7	1.18	30.0	.84	21.3	1.89	48.0	Nylon 6.6	Black Base, White Arm	Two #6 (M3) Screws	10	50
RER.75-S6-X	.75	19.0	1.18	30.0	1.12	28.4	2.21	56.1				10	50
RER1.25-S6-X	1.25	31.8	1.18	30.0	1.64	41.7	2.86	72.6				10	50

Elastic Retainers – ER Type

- Cable bundles are formed as cable bundles are inserted
- Completed bundles can be easily removed
- For indoor use only

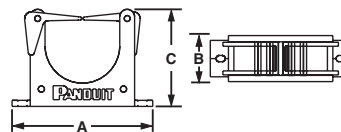

Part Number	Max. Bundle Diameter		Length A		Width B		Height C		Material	Color	Mounting Method	Std. Pkg. Qty.	Std. Ctn. Qty.
	In.	mm	In.	mm	In.	mm	In.	mm					
ER.5-E4-X	.50	12.7	1.96	49.8	.56	14.2	1.00	25.4	Nylon 6.6	Black	Two #6 (M3) Screws	10	100
ER1.25-E4-X	1.25	31.8	2.90	73.7	.95	24.1	2.00	50.8				10	100

A. System Overview

B1. Cable Ties

B2. Cable Accessories

B3. Stainless Steel Ties

C1. Wiring Duct

C2. Surface Raceway

C3. Abrasion Protection

C4. Cable Management

D1. Terminals

D2. Power Connectors

D3. Grounding Connectors

E1. Labeling Systems

E2. Labels

E3. Pre-Printed & Write-On Markers

E4. Permanent Identification

E5. Lockout/Tagout & Safety Solutions

F. Index

Bundle Retainers

- Funnel entry allows fast cable insertion
- Completed bundles can be easily removed
- For indoor use only
- Color: Black

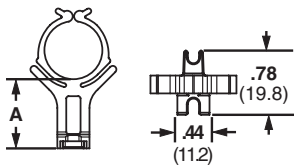

BR.5 and BR.75

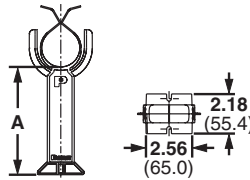

BR2

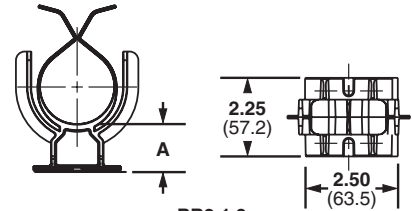

BR2-1.3

Part Number	Max. Bundle Diameter		Standoff Height A		Material	Mounting Method	Std. Pkg. Qty.	Std. Ctn. Qty.
	In.	mm	In.	mm				
BR.5-E6-C	.50	12.7	1.05	26.7	Impact Resistant Nylon 6.6	Two #6 (M3) Screws	100	500
BR.75-E6-C	.75	19.0	.94	23.9			100	500
BR2-1.3-X	2.00	50.8	1.32	33.5			10	100
BR2-1.3-A-X	2.00	50.8	1.35	34.3	Glass Filled Nylon 6.6	Rubber Adhesive	10	0
BR2-1.5-X	2.00	50.8	1.59	40.4		10	100	
BR2-4-X	2.00	50.8	4.06	103.1		10	100	
BR2-6-X	2.00	50.8	6.02	152.9		10	100	

Corner Posts

- Designed to pre-form tight bundles at harness corners and breakouts
- Top arm rotates upward for easy removal of completed harness
- For indoor use only

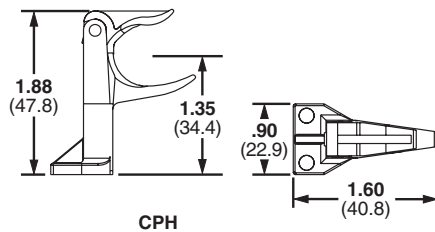

CPH

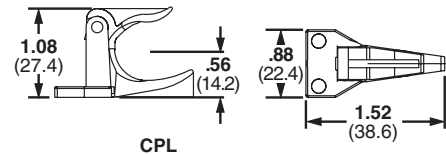

CPL

Part Number	Max. Bundle Diameter		Material	Color	Mounting Method	Std. Pkg. Qty.	Std. Ctn. Qty.
	In.	mm					
CPH.75-S8-X	.75	19.0	Nylon 6.6	Black	Two #8 (M4) Screws	10	100
CPL.75-S8-X							

T-Junction Fixture

- Forms cable junctions
- Fixture moves down for easy harness removal
- For indoor use only

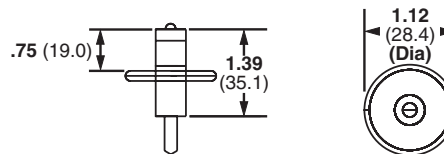

Part Number	Max. Bundle Diameter		Material	Color	Mounting Method	Std. Pkg. Qty.	Std. Ctn. Qty.
	In.	mm					
TJF-X	1.34	34.0	Nylon 6.6 and Nickel Plated Steel	Black	Nail	10	100

Wire End Holder

- Secures wire ends while harness is being fabricated
- Used with #28 thru #16 AWG wires

- For indoor use only

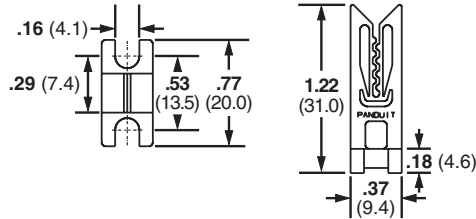

Part Number	Material	Color	Mounting Method	Std. Pkg. Qty.	Std. Ctn. Qty.
WEH-E8-C	Acetal	Black	Two #8 (M4) Screws	100	1000

Harness Board Nails

- Speed routing of wires
- Uniform driving depth is insured by a collar stop

- Smooth finish on nails prevents abrasion to wire jackets
- For indoor use only

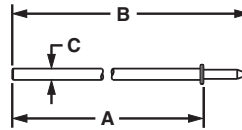

Part Number	Length A		Overall Length B		Thickness C		Material	Mounting Method	Std. Pkg. Qty.	Std. Ctn. Qty.
	In.	mm	In.	mm	In.	mm				
HBN.75-T	.75	19.1	1.37	34.8	.07	1.9	Nickel Plated Steel	Hammered into harness board	200	1000
HBN1-T	1.00	25.4	1.62	41.1	.07	1.9			200	1000
HBN1.5-T	1.50	38.1	2.12	53.8	.08	2.1			200	1000
HBN2-T	2.00	50.8	2.62	66.5	.09	2.4			200	1000
HBN2.5-T	2.50	63.5	3.12	79.2	.11	2.8			200	1000
HBN3-T	3.00	76.2	3.62	91.9	.12	3.0			200	1000
HBN4-T	4.00	101.6	4.62	117.3	.14	3.7			200	1000

A. System Overview

Fanning Strip System

- Holds wires in a specific orientation
- No sharp edges to damage wire insulation
- Will accept wires up to 18 AWG
- Fanning strip can remain as part of completed harness

B1. Cable Ties

B2. Cable Accessories

B3. Stainless Steel Ties

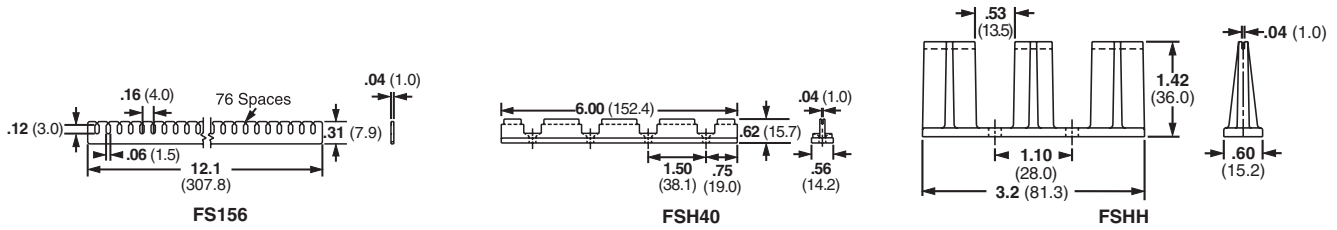

C1. Wiring Duct

C2. Surface Raceway



Part Number	Material	Color	Mounting Method	Std. Pkg. Qty.	Std. Ctn. Qty.
FS156-C	Nylon 6.6	Natural	—	100	1000
FSH40-X	ABS	Black	Four #8 (M4) Screws	10	100
FSHH-X			Two #8 (M4) Screws	10	100

C3. Abrasion Protection

C4. Cable Management

Spring Wire Breakout System

- Harness board spring and spring holder holds wire ends secure while harness is being fabricated
- Wires simply pull out from spring when harness is removed
- Each SHH Spring Holder is supplied with one rigid wire piece to hold the spring laterally and two #8 (M4), 2 inch (50.8mm) hex head wood screws

D1. Terminals

D2. Power Connectors

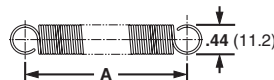

PBSC

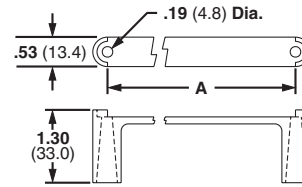

SHH

D3. Grounding Connectors

Part Number	Hole Spacing A		Material	Color	Mounting Method	Std. Pkg. Qty.	Std. Ctn. Qty.
	In.	mm					
PBSC1-X	1.00	25.4	Steel	—	SHH1 Spring Holder	10	100
PBSC3-X	3.00	76.2			—	10	100
PBSC6-X	6.00	152.4			SHH3 Spring Holder	10	100
PBSC12-X	12.00	304.8			—	10	100
SHH1-S8-X	1.85	47.0	Nylon 6.6	Natural	Two #8 (M4) Screws	10	100
SHH3-S8-X	6.80	172.7			#8 (M4) Screws	10	100

E1. Labeling Systems

E2. Labels

E3. Pre-Printed & Write-On Markers

E4. Permanent Identification

E5. Lockout/Tagout & Safety Solutions

F. Index

Harness Board Standoff Posts and Adaptor

- Used to hold a push mount accessory or cable tie at a specific location on a harness board

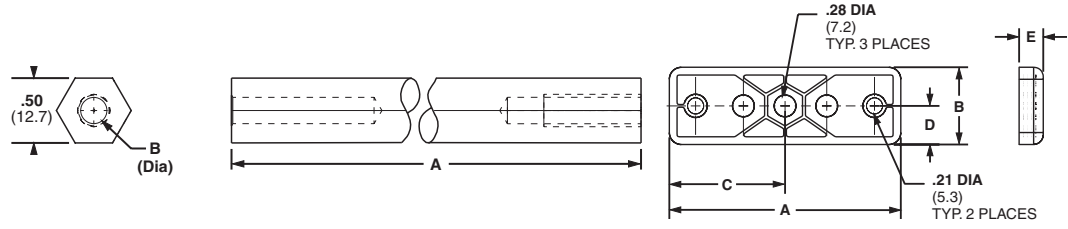

Part Number	Height A		Hole Diameter B		Length C		Width D		For Use With	Material	Mounting Method	Std. Pkg. Qty.	Std. Ctn. Qty.
	In.	mm	In.	mm	In.	m	In.	mm					
HB2SP19-X	2.00	50.8	.20	5.1	2.00	50.8	—	—	PLWP, PRWP, WS, VWS, HWS, TPM	Aluminum	1/4" Screw	10	100
HB2SP25-X	4.00	101.6	.30	7.5	4.00	101.6	—	—	PLWP, PRWP, PLP, THMS, HCMP, PMCC	Aluminum	1/4" Screw	10	100
HBUA-X	.31	7.9	.28	7.1	3.00	76.2	1.00	25.4	HB2SP19-X, HB2SP25-X	Nylon 6.6	#10 (M5) Screw	10	100

A.
System
Overview

B1.
Cable Ties

B2.
Cable
Accessories

B3.
Stainless
Steel Ties

C1.
Wiring
Duct

C2.
Surface
Raceway

C3.
Abrasion
Protection

C4.
Cable
Management

D1.
Terminals

D2.
Power
Connectors

D3.
Grounding
Connectors

E1.
Labeling
Systems

E2.
Labels

E3.
Pre-Printed
& Write-On
Markers

E4.
Permanent
Identification

E5.
Lockout/
Tagout
& Safety
Solutions

F.
Index

A. System Overview

Physical Properties and Colors of Cable Accessory Materials

Design Criteria	Nylon 6.6		Weather Resistant Nylon 6.6	Impact Modified Weather Resistant Nylon 6.6	Heat Stabilized Nylon 6.6	Flame Retardant Nylon 6.6		Glass Filled Flame Retardant Nylon 6.6
	Natural	Black	Black	Black	Black	Black	Natural	Black
Color	Natural	Black	Black	Black	Black	Black	Natural	Black
Part Number Suffix	None	20	0	0	30	60	69	None
UL Flammability – UL 94	V-2	V-2	V-2	HB	V-2	V-0	V-0	V-0
Gamma Radiation Resistance	1x10 ⁵ Rads	1x10 ⁵ Rads	1x10 ⁵ Rads	N/A	1x10 ⁵ Rads	1x10 ⁵ Rads	1x10 ⁵ Rads	N/A
Water Absorption	1.2% (24 hrs.)	1.2% (24 hrs.)	1.2% (24 hrs.)	1.2% (24 hrs.)	1.2% (24 hrs.)	1.1% (24 hrs.)	1.1% (24 hrs.)	0.7% (24 hrs.)
UV Resistance	Poor	Fair	Good	Good	Fair	Poor	Poor	Poor
Maximum Continuous Use Temperature	185°F (85°C)	185°F (85°C)	185°F (85°C)	185°F (85°C)	257°F (125°C)	230°F (110°C)	230°F (110°C)	230°F (110°C)
Minimum Continuous Use Temperature	-40°F (-40°C)	-40°F (-40°C)	-40°F (-40°C)	-40°F (-40°C)	-40°F (-40°C)	-40°F (-40°C)	-40°F (-40°C)	-40°F (-40°C)

B1. Cable Ties

B2. Cable Accessories

B3. Stainless Steel Ties

C1. Wiring Duct

C2. Surface Raceway

C3. Abrasion Protection

Physical Properties and Colors of Cable Accessory Materials (continued)

Design Criteria	Heat Stabilized Nylon 6		TEFZEL [®]	General Purpose Polypropylene	Weather Resistant Polypropylene	General Purpose ABS		Weather Resistant ABS	Flame Retardant Polycarbonate	Acetal	PVC
	Black	Natural	Aqua	Black	Black	Black	Natural	Black	Black	Black	Gray, White
Color	Black	Natural	Aqua	Black	Black	Black	Natural	Black	Black	Black	Gray, White
Part Number Suffix	630	639	76	None/109	100	None	20	0	None	None	810
UL Flammability – UL 94	HB	HB	V-0	HB	HB	HB	HB	HB	V-0	HB	V-0
Gamma Radiation Resistance	N/A	N/A	2x10 Rads	1x10 Rads	1x10 Rads	N/A	N/A	N/A	N/A	N/A	N/A
Water Absorption (24 Hours)	1.5% (24 hrs.)	1.5% (24 hrs.)	<.3% (24 hrs.)	.1% (24 hrs.)	.1% (24 hrs.)	.3% (24 hrs.)	.3% (24 hrs.)	.3% (24 hrs.)	.15% (24 hrs.)	.43% (24 hrs.)	.3% (24 hrs.)
UV Resistance	Fair	Poor	Excellent	Poor	Good	Poor	Fair	Good	Good	Fair	Poor
Maximum Continuous Use Temperature	250°F (121°C)	250°F (121°C)	302°F (150°C)	221°F (105°C)	221°F (105°C)	185°F (85°C)	185°F (85°C)	185°F (85°C)	257°F (125°C)	194°F (90°C)	122°F (50°C)
Minimum Continuous Use Temperature	-40°F (-40°C)	-40°F (-40°C)	-50°F (-46°C)	-40°F (-40°C)	-40°F (-40°C)	-40°F (-40°C)	-40°F (-40°C)	-40°F (-40°C)	-40°F (-40°C)	-40°F (-40°C)	-40°F (-40°C)

C4. Cable Management

D1. Terminals

D2. Power Connectors

D3. Grounding Connectors

E1. Labeling Systems

E2. Labels

E3. Pre-Printed & Write-On Markers

E4. Permanent Identification

E5. Lockout/Tagout & Safety Solutions

F. Index

[®]TEFZEL is a registered trademark of E.I. du Pont de Nemours and Company.

Selection and Use of Adhesive Mounts

PANDUIT adhesive mounts provide a quick, economical, and dependable method of supporting, routing, and protecting wires or cables. Some are used with PANDUIT cable ties and others can be used without cable ties. Adhesive backed mounts adhere to a variety of surfaces. This alternative to mechanical fasteners offers the advantage of lower installed cost with safe, easy to use, quality products.



Applications

- To route wires in control panels and switchboards
- To support bundles of wires away from moving mechanical devices
- Routing and harnessing cables, both indoors and out, to prevent safety hazards
- To organize flat cables in many locations with low profile construction
- Ideal for supporting wire bundles where holes cannot be made in the substrate
- To separate groups of wires for identification



Selection and Use of Adhesive Mounts (continued)

General Mount Guidelines

PANDUIT pressure sensitive adhesive (foam tape) mounts are intended to secure wire bundles or other light objects to smooth surfaces. These mounts are not designed to support excessive loads and should not be used when the maximum expected load exceeds the rated capacity of the mount.

Choosing the Right Adhesive

PANDUIT offers two standard pressure sensitive foam tapes which are available on most adhesive backed wiring accessories products. The general purpose tape is produced with a rubber based adhesive and is identified by an “-A” in the part number. This tape develops its strength extremely fast and can be used in environments with temperatures ranging from -20°F (-40°C) to +120°F (49°C). It is recommended that rubber based adhesive mounts dwell 2 hours after installation, prior to loading. Rubber based adhesive tape is the best choice for most adhesive mount applications, including powder coated surfaces.

Acrylic based adhesive tape is also available and is identified by an “-AT” in the part number. This tape is for use in environments where continuous exposure to temperatures as high as 180°F (82°C) is possible. Acrylic based adhesive develops its maximum strength over a longer period of time than rubber based adhesive. It is recommended that acrylic adhesive mounts dwell 8 hours after installation, prior to loading. Acrylic based adhesive tape is a good choice for environments with prolonged exposure to UV rays or temperatures above 120°F (49°C).

PANDUIT also offers a 2-part epoxy for use in applications where excessive loading is required, or where the surface to which the mount must be applied is porous rather than smooth. PANDUIT EMA adhesive is a 2-part epoxy cement which is packaged in convenient mixer cups containing an equal amount of resin and hardener. Peel the protective covering off and pop the center of the cup in to form a mixing bowl. Each cup is supplied with a mixer stick and contains enough epoxy to properly apply three EMS mounts. The resin and hardener should be thoroughly mixed together until the epoxy is a consistent and uniform color. The mixer stick can then be used to apply the adhesive to the mount. The epoxy should be forced into the grooves on the bottom of the mount to obtain optimum bond performance. The mount should be applied to the surface with light pressure and a back-and-forth twisting motion. Hardening of the epoxy begins five minutes after mixing at room temperature.

Application Chart

Since PANDUIT manufactures adhesive backed mounts with a variety of adhesive types, this chart should be used as a guideline for choosing the best adhesive for often-encountered conditions. Each type of adhesive is rated good, fair or poor for some specific mounting surfaces and/or chemical environments.

Surfaces	Rubber Based Foam Tape Mounts	Acrylic Based Foam Tape Mounts	Epoxy Applied Adhesive Mounts
Plastics	Good	Good	Good
Wood	Good	Good	Good
Glass	Fair	Good	Good
Painted Surfaces	Good	Good	Fair
Powder Coating	Good	Fair	Good
Metal	Good ¹	Good ¹	Good
Paper	Good	Good	Fair
Concrete, Stone, Masonry	Not Recommended	Not Recommended	Good
Chemical Resistance			
Water	Good	Good	Poor
Oil	Poor	Fair ³	Good
Gasoline	Poor	Fair ³	Fair
Dilute Acids	Poor	Fair ³	Fair
Dilute Alkalis	Good	Fair ³	Fair
Organic Solvents	Poor	Fair ³	Not Recommended
Outdoor Exposure	Not Recommended	Good	Good ²

1. Not recommended for use on copper or brass.
2. Mounts manufactured from outdoor material only. For specific applications, individual testing prior to extensive use is suggested.
3. Depends on concentration, exposure time, and chemical composition.

Mount Spacing

To determine the number of mounts to use in a given application, the following formula can be used as a guideline:

$$\frac{\text{Cable or weight (Lbs./ft.)}}{\text{Static Load rating of Mount (Lbs./mt.)}} = \text{Spacing} \frac{\text{Mounts}}{\text{Ft.}}$$

A.
System
Overview

B1.
Cable
Ties

B2.
Cable
Accessories

B3.
Stainless
Steel Ties

C1.
Wiring
Duct

C2.
Surface
Raceway

C3.
Abrasion
Protection

C4.
Cable
Management

D1.
Terminals

D2.
Power
Connectors

D3.
Grounding
Connectors

E1.
Labeling
Systems

E2.
Labels

E3.
Pre-Printed
& Write-On
Markers

E4.
Permanent
Identification

E5.
Lockout/
Tagout
& Safety
Solutions

F.
Index

A. System Overview

Selection and Use of Adhesive Mounts (continued)

B1. Cable Ties

Surface Preparation

For best results, *PANDUIT* adhesive mounts should be applied to clean, dry, grease-free surfaces. We recommend that the surface be cleaned prior to mount installation. For rubber and acrylic based foam tape adhesives, a blend of isopropyl alcohol and water 50/50 may be used to clean most surfaces.

B2. Cable Accessories

For epoxy type adhesives, especially masonry surfaces, be sure to clean all loose particles away before mount installation. Some surface abrasion is recommended to achieve maximum strength. A light rubbing with medium grit emery cloth or sandpaper is best. Wash after abrading.

B3. Stainless Steel Ties

Proper Installation Techniques For Pressure Sensitive Adhesive Mounts

For proper installation of adhesive mounts with foam tape, simply remove the release liner and place the mount in the desired location. Avoid touching the adhesive prior to positioning the mount. Apply firm pressure to the mount for 5 seconds to insure proper adhesion.

C1. Wiring Duct

C2. Surface Raceway

C3. Abrasion Protection

C4. Cable Management

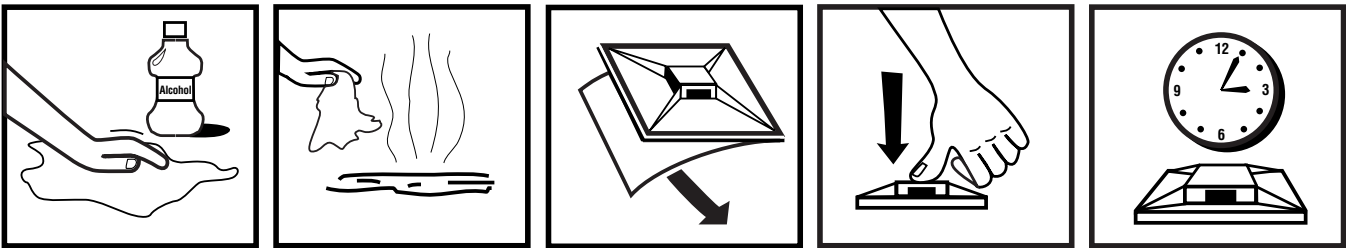

1) Clean surface with a clean cloth and isopropyl alcohol.

2) Allow surface to air dry.

3) Remove the release liner, being careful not to touch the adhesive.

4) Apply full thumb pressure for at least 5 seconds.

5) Allow mount to properly dwell.

D1. Terminals

Proper Storage Conditions

All *PANDUIT* adhesive products have an expiration date printed on the package label. Use the following storage guidelines:

D2. Power Connectors

1. For rubber and acrylic based foam tape adhesives, store in temperatures of 70°F (21°C) and 45% Relative Humidity (R.H.).

D3. Grounding Connectors

2. For epoxy type adhesives, store in temperatures of 40°F (4°C) to 75°F (25°C) and relative humidity not in excess of 45%. Storage in opened containers is not recommended. Using the guidelines above, the shelf life of foam tape is 3 years. Shelf life of epoxy is 1 year. Deviation from the recommended storage conditions may reduce the shelf life or adhesive strength. In any case, adhesive products should never be stored near heating vents or other heat sources, and storage in lower temperatures than those recommended may increase the shelf life.

E1. Labeling Systems

E2. Labels

Stock Rotation

Adhesive mount inventory should be rotated in order to insure the quality of the adhesive foam tape. Each package of *PANDUIT* adhesive backed mounts has a Quality Control Number and a best-if-used-by date on the package label. The best-if-used-by date provides the customer with an accurate way to control the rotation of inventory, and, as is the case with all *PANDUIT* products, the Quality Control Number provides complete traceability for all components that go into a specific production run of product.

E3. Pre-Printed & Write-On Markers

E4. Permanent Identification

E5. Lockout/Tagout & Safety Solutions

F. Index

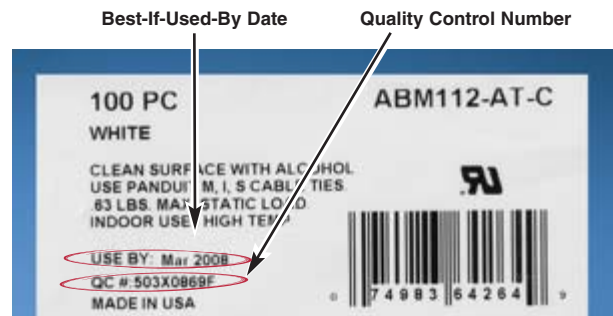

Mount Removal

There is no simple or easy method for removing *PANDUIT* adhesives. A thin wire or razor blade can be moved in between the surfaces when removing foam tape mounts; however, the adhesive residue will remain on the surface. Epoxy adhesives may be removed with a commercial paint stripping solution.

PAN-STEEL® SYSTEM

The *PAN-STEEL*® System provides a strong, durable method of bundling and mechanical fastening, for all indoor, outdoor, and underground (including direct burial) applications. The ties are designed for use in critical applications where strength, vibration, radiation, weathering, corrosion and temperature extremes are a factor.

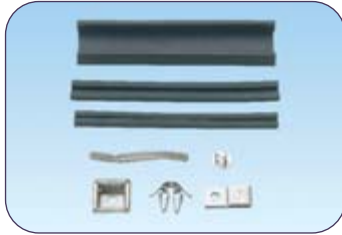
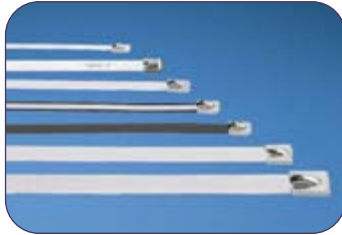

- Patented locking head design assures locking in any position, with a high rated loop tensile strength for a durable solution that delivers an extra margin of safety
- 304 or 316 grade stainless steel provides a strong, long-lasting method of bundling and mechanical fastening in harsh environments
- Accessories available to protect, speed, and simplify the mounting of wires, cable, and tubing with *PANDUIT*® *PAN-STEEL*® Stainless Steel Cable Ties
- Complete line of manual and pneumatic installation tools available with controlled tension and automatic cut-off for lower installed cost
- Large selection of stainless steel marker plates, tags, and cable ties to deliver maximum design flexibility to match your specific application requirements; for details, refer to Permanent Identification Section E4

PANDUIT continues to develop stainless steel solutions for harsh environment applications by solving customer problems with innovative products and reliable tooling to achieve lowest installed cost.

A.
System
Overview

B1.
Cable Ties

B2.
Cable
Accessories

B3.
Stainless
Steel Ties

C1.
Wiring
Duct

C2.
Surface
Raceway

C3.
Abrasion
Protection

C4.
Cable
Management

D1.
Terminals

D2.
Power
Connectors

D3.
Grounding
Connectors

E1.
Labeling
Systems

E2.
Labels

E3.
Pre-Printed
& Write-On
Markers

E4.
Permanent
Identification

E5.
Lockout/
Tagout
& Safety
Solutions

F.
Index

A.
System
Overview

PAN-STEEL® Products Overview

B1.
Cable Ties

PAN-STEEL® Cable Ties

Pages B3.4 – B3.7, B3.11, B3.13

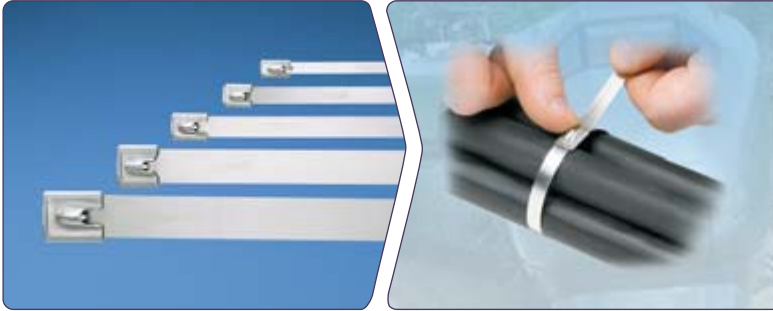

- Designed for use in indoor, outdoor, and underground applications
- Self-locking head design speeds installation
- Strong, durable method of cable bundling
- Rounded edges assure cable protection and worker safety

C1.
Wiring
Duct

C2.
Surface
Raceway

PAN-STEEL® Coated Cable Ties

Pages B3.8 – B3.9, B3.12 – B3.13

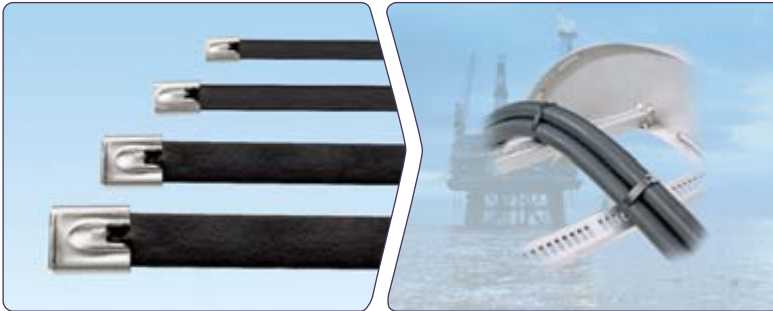

- Designed for use in indoor, outdoor, and underground applications
- Self-locking head design speeds installation
- Provides additional edge protection
- Prevents corrosion between dissimilar metals

C3.
Abrasion
Protection

C4.
Cable
Management

D1.
Terminals

D2.
Power
Connectors

PAN-ALUM™ Cable Ties

Page B3.10

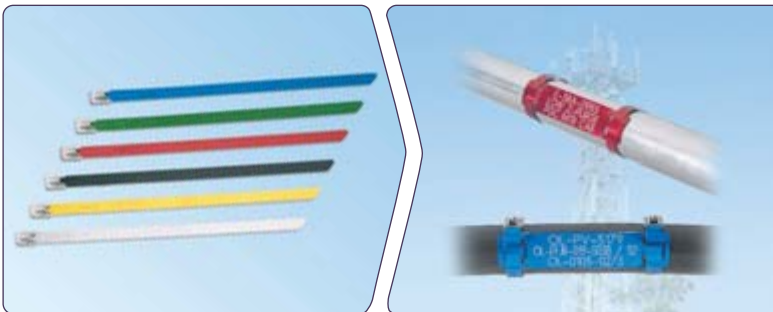

- Ideal for use in permanent identification and color-coding applications
- Five color options in addition to natural aluminum
- Lightweight construction for flexibility and ease of handling
- Used with aluminum marker plates for fast and easy installation

D3.
Grounding
Connectors

E1.
Labeling
Systems

E2.
Labels

E3.
Pre-Printed
& Write-On
Markers

PAN-STEEL® Retained Tension Ties

Pages B3.17 – B3.20



- Designed for use in Industrial, OEM, and Transportation Markets
- Provides tight bundling of armored cables, pipes, conduit and rigid materials
- Locks into place at any length along the tie body
- 360° seal design option eliminates gaps for a completely sealed installation

E4.
Permanent
Identification

E5.
Lockout/
Tagout
& Safety
Solutions

F.
Index

PAN-STEEL® Products Overview (continued)

Installation Tools

Pages B3.14 – B3.16, B3.20, B3.26



- Used in production, maintenance, and construction applications
- Full line of lightweight, ergonomic hand tools
- Highest reliability in the industry
- Flush cut-off of ties limits exposure to sharp edges

PAN-STEEL® Strapping

Pages B3.21 – B3.25



- Fold over design provides high retained tension
- Cut end is locked inside low profile buckle – no sharp edges
- Coil-in-box packaging option for job site versatility with minimum inventory
- Coated design option for additional edge protection

Accessories

Pages B3.26 – B3.29

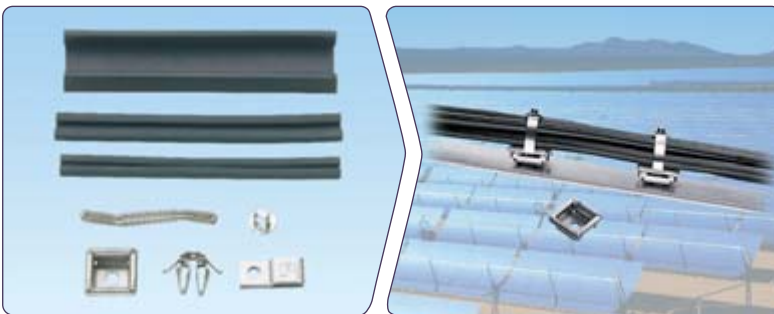

- Cushion sleeving provides full separation between ties and bundles
- Multiple mount options for range of applications and panel thicknesses
- Mounts secure ties to structure quickly and easily

Permanent Identification Products

Pages E4.1 – E4.6



- Withstand the test of time and provide legibility in harsh environments
- Factory Custom Marking Service creates custom embossed or laser etched metal plates, tags, and ties
- Portable marking tools for quick and easy on-site identification
- Large selection delivers maximum design flexibility

A.
System
Overview

B1.
Cable Ties

B2.
Cable
Accessories

B3.
Stainless
Steel Ties

C1.
Wiring
Duct

C2.
Surface
Raceway

C3.
Abrasion
Protection

C4.
Cable
Management

D1.
Terminals

D2.
Power
Connectors

D3.
Grounding
Connectors

E1.
Labeling
Systems

E2.
Labels

E3.
Pre-Printed
& Write-On
Markers

E4.
Permanent
Identification

E5.
Lockout/
Tagout/
& Safety
Solutions

F.
Index

A. System Overview

Features and Benefits – PAN-STEEL® Cable Ties

PANDUIT® PAN-STEEL® Stainless Steel Ties are engineered for safety, productivity, and durability by providing round edges and smooth surfaces, easy threading, high loop tensile strength and tight clamping.

B1. Cable Ties

B2. Cable Accessories

B3. Stainless Steel Ties

Self-Locking Head Construction*

Aggressive locking head
Quicker locking, tighter installation

Unique locking ramp
Assures locking in any position

Lead in design
Wider entrance for easier threading

Strengthening ribs
Stronger head increases lock strength

Innovative displacement lock
Assures superior locking strength

Extended retaining tab
Increases overall tie strength

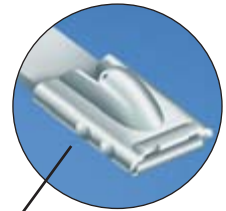
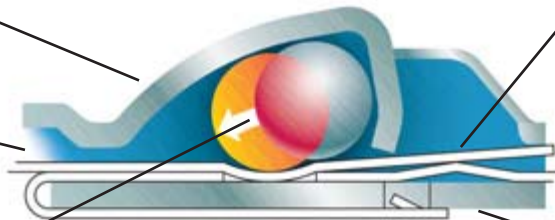

*Patents applied for

C1. Wiring Duct

C2. Surface Raceway

C3. Abrasion Protection

C4. Cable Management

Fully Rounded Edges

Self-Locking for Fast Installation

D1. Terminals



PANDUIT tie body

Other manufacturer's tie body

The PAN-STEEL® Stainless Steel Cable Tie features fully rounded edges to assure bundle protection and operator safety. PANDUIT not only removes the burr, but actually passes the material through a secondary process which removes the top and bottom corners of the material.



Self-locking design can be fastened by hand requiring no fold over or additional installation steps.

PAN-STEEL® Installation Tools for adjustable tension control and automatic cut-off for quick, consistent, and secure installation.

D2. Power Connectors

D3. Grounding Connectors

E1. Labeling Systems

E2. Labels

E3. Pre-Printed & Write-On Markers

E4. Permanent Identification

E5. Lockout/Tagout & Safety Solutions

F. Index



Large selection of installation tools, the proper tool available to meet the requirements of every application. See pages B3.14 – B3.16.

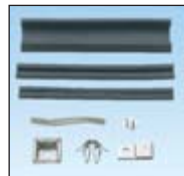

PAN-STEEL® System Accessories are used with PAN-STEEL® Stainless Steel Cable Ties to speed and simplify the mounting of wires, cables, and tubing. Installation methods include screw mounts and push mounts. See pages B3.26 – B3.29.



PAN-STEEL® Permanent Identification Solutions are designed for use with PANDUIT® PAN-STEEL® Stainless Cable Ties and PAN-ALUM™ Aluminum Cable Ties for quick and easy on-demand identification in harsh environments. See pages E4.1 – E4.6.

Part Number System for PAN-STEEL® Cable Ties

MLT	6	S	—	CP	
Type	Bundle Diameter Reference (In.)	Cross Section		Standard Package Size	Material
MLT = Metal Locking Tie		S = Standard LH = Light Heavy H = Heavy EH = Extra-Heavy EH-15 = Extra-Heavy-15 SH = Super-Heavy		Q = 25 L* = 50 LP** = 50 CP = 100 *Standard Cross Section **Heavy Cross Section	(blank) = 304 316 = 316

PAN-STEEL® Self-Locking Cable Ties – MLT Series

- Self-locking head design speeds installation and locks into place at any length along the tie body
- Provides a strong, durable method of cable bundling
- Can be used in a wide range of indoor, outdoor, and underground (including direct burial) applications
- Smooth surfaces and rounded edges assures cable protection and worker safety
- Available in AISI 304 stainless steel for general-purpose applications
- Available in AISI 316 stainless steel for the most corrosive environments



Part Number	Max. Bundle Diameter		Length*		Min. Loop Tensile Strength**		Min. Bundle Diameter		Width		Thickness		Recommended Installation Tool***	Std. Pkg. Qty.	Std. Ctn. Qty.
	In.	mm	In.	mm	Lbs.	N	In.	mm	In.	mm	In.	mm			

AISI 304 Stainless Steel – For General Purpose

Standard Cross Section

MLT1S-CP	1.0	25	5.0	127	200	890	.50	12.7	.18	4.6	.010	.25	GS4MT, HTMT, PPTMT, ST2MT	100	500
MLT2S-CP	2.0	51	7.9	201	200	890	.50	12.7	.18	4.6	.010	.25		100	500
MLT2S-L	2.0	51	7.9	201	200	890	.50	12.7	.18	4.6	.010	.25		50	500
MLT2.7S-CP	2.7	69	10.2	259	200	890	.50	12.7	.18	4.6	.010	.25		100	500
MLT4S-CP	4.0	102	14.3	362	200	890	.50	12.7	.18	4.6	.010	.25		100	500
MLT4S-L	4.0	102	14.3	362	200	890	.50	12.7	.18	4.6	.010	.25		50	500
MLT6S-CP	6.0	152	20.5	521	200	890	.50	12.7	.18	4.6	.010	.25		100	500
MLT8S-CP	8.0	203	26.8	679	200	890	.50	12.7	.18	4.6	.010	.25		100	500
MLT10S-CP	10.0	254	33.0	838	200	890	.50	12.7	.18	4.6	.010	.25		100	500
MLT12S-Q	12.0	304	39.3	998	200	890	.50	12.7	.18	4.6	.010	.25		25	125
MLT14S-Q	14.0	355	45.5	1156	200	890	.50	12.7	.18	4.6	.010	.25		25	125
MLT15S-Q	15.0	380	49.2	1250	200	890	.50	12.7	.18	4.6	.010	.25		25	125

*Other lengths available, contact PANDUIT Customer Service.

**Per SAE Standard AS23190/3 (formerly MIL). For additional details, refer to page B3.32.

***For information on installation tools, refer to pages B3.14 – B3.16.

Table continued on page B3.6

A. System Overview



PAN-STEEL® Self-Locking Cable Ties – MLT Series (continued)

B1. Cable Ties

B2. Cable Accessories

B3. Stainless Steel Ties

C1. Wiring Duct

C2. Surface Raceway

C3. Abrasion Protection

C4. Cable Management

D1. Terminals

D2. Power Connectors

D3. Grounding Connectors

E1. Labeling Systems

E2. Labels

E3. Pre-Printed & Write-On Markers

E4. Permanent Identification

E5. Lockout/Tagout & Safety Solutions

F. Index

Part Number	Max. Bundle Diameter		Length*		Min. Loop Tensile Strength**		Min. Bundle Diameter		Width		Thickness		Recommended Installation Tool***	Std. Pkg. Qty.	Std. Ctn. Qty.	
	In.	mm	In.	mm	Lbs.	N	In.	mm	In.	mm	In.	mm				
Light-Heavy Cross Section																
MLT2LH-LP	2.0	51	7.9	201	250	1112	.50	12.7	.25	6.4	.010	.25	GS4MT, HTMT, PPTMT, ST2MT	50	250	
MLT4LH-LP	4.0	102	14.3	362	250	1112	.50	12.7	.25	6.4	.010	.25		50	250	
MLT6LH-LP	6.0	152	20.5	521	250	1112	.50	12.7	.25	6.4	.010	.25		50	250	
MLT8LH-LP	8.0	203	26.8	679	250	1112	.50	12.7	.25	6.4	.010	.25		50	250	
Heavy Cross Section																
MLT2H-LP	2.0	51	7.9	201	450	2000	.50	12.7	.31	7.9	.010	.25	GS4MT, HTMT, PPTMT, ST2MT	50	250	
MLT2.7H-LP	2.7	69	10.2	259	450	2000	.50	12.7	.31	7.9	.010	.25		50	250	
MLT4H-LP	4.0	102	14.3	362	450	2000	.50	12.7	.31	7.9	.010	.25		50	250	
MLT6H-LP	6.0	152	20.5	521	450	2000	.50	12.7	.31	7.9	.010	.25		50	250	
MLT8H-LP	8.0	203	26.8	679	450	2000	.50	12.7	.31	7.9	.010	.25		50	250	
MLT10H-LP	10.0	254	33.0	838	450	2000	.50	12.7	.31	7.9	.010	.25		50	250	
MLT12H-Q	12.0	304	39.3	998	450	2000	.50	12.7	.31	7.9	.010	.25	25	125		
MLT14H-Q	14.0	355	45.5	1156	450	2000	.50	12.7	.31	7.9	.010	.25	25	125		
Extra-Heavy Cross Section																
MLT4EH-LP	4.0	102	17.1	434	600	2670	1.0	25.4	.50	12.7	.010	.25	ST2MT, RT1HT, RT1HTN	50	250	
MLT6EH-LP	6.0	152	23.4	594	600	2670	1.0	25.4	.50	12.7	.010	.25		50	250	
MLT8EH-LP	8.0	203	29.7	754	600	2670	1.0	25.4	.50	12.7	.010	.25		50	250	
MLT10EH-LP	10.0	254	35.9	912	600	2670	1.0	25.4	.50	12.7	.010	.25		50	250	
MLT12EH-Q	12.0	305	42.2	1072	600	2670	1.0	25.4	.50	12.7	.010	.25		25	125	
MLT4EH15-LP	4.0	102	17.1	434	700	3115	1.0	25.4	.50	12.7	.015	.38		50	250	
MLT6EH15-LP	6.0	152	23.4	594	700	3115	1.0	25.4	.50	12.7	.015	.38		50	250	
MLT8EH15-LP	8.0	203	29.7	754	700	3115	1.0	25.4	.50	12.7	.015	.38		50	250	
MLT10EH15-LP	10.0	254	35.9	912	700	3115	1.0	25.4	.50	12.7	.015	.38		50	250	
MLT12EH15-Q	12.0	305	42.2	1072	700	3115	1.0	25.4	.50	12.7	.015	.38		25	125	
Super-Heavy Cross Section																
MLT4SH-LP	4.0	102	17.1	434	900	4005	1.0	25.4	.63	15.9	.015	.38		RT1HT, RT1HTN	50	250
MLT6SH-LP	6.0	152	23.4	594	900	4005	1.0	25.4	.63	15.9	.015	.38	50		250	
MLT8SH-LP	8.0	203	29.7	754	900	4005	1.0	25.4	.63	15.9	.015	.38	50		250	
MLT10SH-LP	10.0	254	35.9	912	900	4005	1.0	25.4	.63	15.9	.015	.38	50		250	
MLT12SH-Q	12.0	305	42.2	1072	900	4005	1.0	25.4	.63	15.9	.015	.38	25		125	
AISI 316 Stainless Steel – For Superior Corrosion Resistance																
Standard Cross Section																
MLT1S-CP316	1.0	25	5.0	127	200	890	.50	12.7	.18	4.6	.010	.25	GS4MT, HTMT, PPTMT, ST2MT	100	500	
MLT2S-CP316	2.0	51	7.9	201	200	890	.50	12.7	.18	4.6	.010	.25		100	500	
MLT2.7S-CP316	2.7	69	10.2	259	200	890	.50	12.7	.18	4.6	.010	.25		100	500	
MLT4S-CP316	4.0	102	14.3	362	200	890	.50	12.7	.18	4.6	.010	.25		100	500	
MLT6S-CP316	6.0	152	20.5	521	200	890	.50	12.7	.18	4.6	.010	.25		100	500	
MLT8S-CP316	8.0	203	26.8	679	200	890	.50	12.7	.18	4.6	.010	.25		100	500	
MLT10S-CP316	10.0	254	33.0	838	200	890	.50	12.7	.18	4.6	.010	.25	100	500		
Light-Heavy Cross Section																
MLT2LH-LP316	2.0	51	7.9	201	250	1112	.50	12.7	.25	6.4	.010	.25	GS4MT, HTMT, PPTMT, ST2MT	50	250	
MLT4LH-LP316	4.0	102	14.3	362	250	1112	.50	12.7	.25	6.4	.010	.25		50	250	
MLT6LH-LP316	6.0	152	20.5	521	250	1112	.50	12.7	.25	6.4	.010	.25		50	250	
MLT8LH-LP316	8.0	203	26.8	679	250	1112	.50	12.7	.25	6.4	.010	.25		50	250	

*Other lengths available, contact PANDUIT Customer Service.
 **Per SAE Standard AS23190/3 (formerly MIL). For additional details, refer to page B3.32.
 ***For information on installation tools, refer to pages B3.14 – B3.16.



PAN-STEEL® Self-Locking Cable Ties – MLT Series (continued)

Part Number	Max. Bundle Diameter		Length*		Min. Loop Tensile Strength**		Min. Bundle Diameter		Width		Thickness		Recommended Installation Tool***	Std. Pkg. Qty.	Std. Ctn. Qty.
	In.	mm	In.	mm	Lbs.	N	In.	mm	In.	mm	In.	mm			
Heavy Cross Section															
MLT2H-LP316	2.0	51	7.9	201	450	2000	.50	12.7	.31	7.9	.010	.25	GS4MT, HTMT, PPTMT, ST2MT	50	250
MLT2.7H-LP316	2.7	69	10.2	259	450	2000	.50	12.7	.31	7.9	.010	.25		50	250
MLT4H-LP316	4.0	102	14.3	362	450	2000	.50	12.7	.31	7.9	.010	.25		50	250
MLT6H-LP316	6.0	152	20.5	521	450	2000	.50	12.7	.31	7.9	.010	.25		50	250
MLT8H-LP316	8.0	203	26.8	679	450	2000	.50	12.7	.31	7.9	.010	.25		50	250
MLT10H-LP316	10.0	254	33.0	838	450	2000	.50	12.7	.31	7.9	.010	.25		50	250
Extra-Heavy Cross Section															
MLT4EH-LP316	4.0	102	17.1	434	600	2670	1.0	25.4	.50	12.7	.010	.25	ST2MT, RT1HT, RT1HTN	50	250
MLT6EH-LP316	6.0	152	23.4	594	600	2670	1.0	25.4	.50	12.7	.010	.25		50	250
MLT8EH-LP316	8.0	203	29.7	754	600	2670	1.0	25.4	.50	12.7	.010	.25		50	250
MLT4EH15-LP316	4.0	102	17.1	434	700	3115	1.0	25.4	.50	12.7	.015	.38		50	250
MLT6EH15-LP316	6.0	152	23.4	594	700	3115	1.0	25.4	.50	12.7	.015	.38		50	250
MLT8EH15-LP316	8.0	203	29.7	754	700	3115	1.0	25.4	.50	12.7	.015	.38		50	250
Super-Heavy Cross Section															
MLT4SH-LP316	4.0	102	17.1	434	900	4005	1.0	25.4	.63	16.0	.015	.38	RT1HT, RT1HTN	50	250
MLT6SH-LP316	6.0	152	23.4	594	900	4005	1.0	25.4	.63	16.0	.015	.38		50	250
MLT8SH-LP316	8.0	203	29.7	754	900	4005	1.0	25.4	.63	16.0	.015	.38		50	250

*Other lengths available, contact PANDUIT Customer Service.

**Per SAE Standard AS23190/3 (formerly MIL). For additional details, refer to page B3.32.

***For information on installation tools, refer to pages B3.14 – B3.16.

A.
System
Overview

B1.
Cable Ties

B2.
Cable
Accessories

B3.
Stainless
Steel Ties

C1.
Wiring
Duct

C2.
Surface
Raceway

C3.
Abrasion
Protection

C4.
Cable
Management

D1.
Terminals

D2.
Power
Connectors

D3.
Grounding
Connectors

E1.
Labeling
Systems

E2.
Labels

E3.
Pre-Printed
& Write-On
Markers

E4.
Permanent
Identification

E5.
Lockout/
Tagout/
& Safety
Solutions

F.
Index

A. System Overview

PAN-STEEL® Polyester Fully Coated Cable Ties – MLTFC Series

B1. Cable Ties

- Self-locking head design speeds installation and locks into place at any length along the tie body
- Polyester coating provides additional edge protection and prevents corrosion between dissimilar metals
- AISI 316 stainless steel for the most corrosive environments
- Available in standard, heavy, extra-heavy and super-heavy cross sections
- UV resistant, low smoke, halogen-free material
- Temperature tolerance -40°F (-40°C) to 302°F (150°C)

B2. Cable Accessories

B3. Stainless Steel Ties



C1. Wiring Duct

C2. Surface Raceway

C3. Abrasion Protection

C4. Cable Management

D1. Terminals

D2. Power Connectors

D3. Grounding Connectors

E1. Labeling Systems

E2. Labels

E3. Pre-Printed & Write-On Markers

E4. Permanent Identification

E5. Lockout/Tagout & Safety Solutions

F. Index

Part Number	Max. Bundle Diameter		Length*		Min. Loop Tensile Strength**		Min. Bundle Diameter		Width		Thickness^		Recommended Installation Tool***	Std. Pkg. Qty.	Std. Ctn. Qty.
	In.	mm	In.	mm	Lbs.	N	In.	mm	In.	mm	In.	mm			
Standard Cross Section															
MLTFC2S-CP316	2.0	51	7.9	201	100	445	.50	12.7	.18	4.6	.010	.25	GS4MT, HTMT, PPTMT, ST2MT	100	500
MLTFC4S-CP316	4.0	102	14.3	362	100	445	.50	12.7	.18	4.6	.010	.25		100	500
MLTFC6S-CP316	6.0	152	20.5	521	100	445	.50	12.7	.18	4.6	.010	.25		100	500
MLTFC8S-CP316	8.0	203	26.8	679	100	445	.50	12.7	.18	4.6	.010	.25		100	500
Heavy Cross Section															
MLTFC2H-LP316	2.0	51	7.9	201	250	1112	.50	12.7	.31	7.9	.010	.25	GS4MT, HTMT, PPTMT, ST2MT	50	250
MLTFC4H-LP316	4.0	102	14.3	362	250	1112	.50	12.7	.31	7.9	.010	.25		50	250
MLTFC6H-LP316	6.0	152	20.5	521	250	1112	.50	12.7	.31	7.9	.010	.25		50	250
MLTFC8H-LP316	8.0	203	26.8	679	250	1112	.50	12.7	.31	7.9	.010	.25		50	250
Extra-Heavy Cross Section															
MLTFC4EH-LP316	4.0	102	17.1	434	300	1335	1.0	25.4	.50	12.7	.010	.25	ST2MT, RT1HT, RT1HTN	50	250
MLTFC6EH-LP316	6.0	152	23.4	594	300	1335	1.0	25.4	.50	12.7	.010	.25		50	250
MLTFC8EH-LP316	8.0	203	29.7	754	300	1335	1.0	25.4	.50	12.7	.010	.25		50	250
Super-Heavy Cross Section															
MLTFC4SH-LP316	4.0	102	17.1	434	450	2000	1.0	25.4	.63	15.9	.015	.38	RT1HT, RT1HTN	50	250
MLTFC6SH-LP316	6.0	152	23.4	594	450	2000	1.0	25.4	.63	15.9	.015	.38		50	250
MLTFC8SH-LP316	8.0	203	29.7	754	450	2000	1.0	25.4	.63	15.9	.015	.38		50	250

*Other lengths available, contact PANDUIT Customer Service.

**Per SAE Standard AS23190/3 (formerly MIL). For additional details, refer to page B3.32.

***For information on installation tools, refer to pages B3.14 – B3.16.

^Base material less coating.

PAN-STEEL® Nylon 11 Selectively Coated Cable Ties – MLTC Series

- Self-locking head design speeds installation and locks into place at any length along the tie body
- Nylon 11 coating provides additional edge protection and prevents corrosion between dissimilar metals
- AISI 316 stainless steel for the most corrosive environments
- Available in heavy cross section
- UV resistant, low smoke, halogen-free material
- Temperature tolerance -40°F (-40°C) to 285°F (140°C)



Part Number	Max. Bundle Diameter		Length*		Min. Loop Tensile Strength**		Min. Bundle Diameter		Width		Thickness^		Recommended Installation Tool***	Std. Pkg. Qty.	Std. Ctn. Qty.
	In.	mm	In.	mm	Lbs.	N	In.	mm	In.	mm	In.	mm			
AISI 316 Stainless Steel – For Nylon 11 Selectively Coated Cable Ties															
Heavy Cross Section															
MLTC2H-LP316	2.0	51	7.9	201	250	1112	.50	12.7	.31	7.9	.010	.25	GS4MT, HTMT, PPTMT, ST2MT	50	250
MLTC4H-LP316	4.0	102	14.3	362	250	1112	.50	12.7	.31	7.9	.010	.25		50	250
MLTC6H-LP316	6.0	152	20.5	521	250	1112	.50	12.7	.31	7.9	.010	.25		50	250
MLTC8H-LP316	8.0	203	26.8	679	250	1112	.50	12.7	.31	7.9	.010	.25		50	250
MLTC10H-LP316	10.0	254	33.0	838	250	1112	.50	12.7	.31	7.9	.010	.25		50	250

*Other lengths available, contact PANDUIT Customer Service.

**Per SAE Standard AS23190/3 (formerly MIL). For additional details, refer to page B3.32.

***For information on installation tools, refer to pages B3.14 – B3.16.

^Base material less coating.

A.
System
Overview

B1.
Cable Ties

B2.
Cable
Accessories

B3.
Stainless
Steel Ties

C1.
Wiring
Duct

C2.
Surface
Raceway

C3.
Abrasion
Protection

C4.
Cable
Management

D1.
Terminals

D2.
Power
Connectors

D3.
Grounding
Connectors

E1.
Labeling
Systems

E2.
Labels

E3.
Pre-Printed
& Write-On
Markers

E4.
Permanent
Identification

E5.
Lockout/
Tagout
& Safety
Solutions

F.
Index

A. System Overview



PAN-ALUM™ Aluminum Cable Ties – MLT Series

B1. Cable Ties

B2. Cable Accessories

B3. Stainless Steel Ties

C1. Wiring Duct

- Self-locking head design speeds installation and locks into place at any length along the tie body
- Lightweight, aluminum construction for flexibility and ease of handling
- Five color options in addition to natural aluminum finish for color-coding applications
- Smooth surfaces and rounded edges assures cable protection and worker safety
- For use with PAN-ALUM™ Marker Plates on page E4.5, for fast installation at the lowest installed cost



C2. Surface Raceway

C3. Abrasion Protection

C4. Cable Management

D1. Terminals

D2. Power Connectors

D3. Grounding Connectors

E1. Labeling Systems

E2. Labels

E3. Pre-Printed & Write-On Markers

E4. Permanent Identification

E5. Lockout/Tagout & Safety Solutions

F. Index

Part Number	Max. Bundle Diameter		Length		Color	Min. Loop Tensile Strength*		Min. Bundle Diameter		Width		Thickness		Recommended Installation Tool**	Std. Pkg. Qty.	Std. Ctn. Qty.
	In.	mm	In.	mm		Lbs.	N	In.	mm	In.	mm	In.	mm			
MLT1H-LPALBL	1.0	25	5.5	140	Black	50	222	.50	12.7	.31	7.9	.012	.03	ST2MT, HTMT	50	250
MLT2H-LPALBL	2.0	51	7.9	201	Black	50	222	.50	12.7	.31	7.9	.012	.03		50	250
MLT4H-LPALBL	4.0	102	14.3	362	Black	50	222	.50	12.7	.31	7.9	.012	.03		50	250
MLT1H-LPALRD	1.0	25	5.5	140	Red	50	222	.50	12.7	.31	7.9	.012	.03		50	250
MLT2H-LPALRD	2.0	51	7.9	201	Red	50	222	.50	12.7	.31	7.9	.012	.03		50	250
MLT4H-LPALRD	4.0	102	14.3	362	Red	50	222	.50	12.7	.31	7.9	.012	.03		50	250
MLT1H-LPALYL	1.0	25	5.5	140	Yellow	50	222	.50	12.7	.31	7.9	.012	.03		50	250
MLT2H-LPALYL	2.0	51	7.9	201	Yellow	50	222	.50	12.7	.31	7.9	.012	.03		50	250
MLT4H-LPALYL	4.0	102	14.3	362	Yellow	50	222	.50	12.7	.31	7.9	.012	.03		50	250
MLT1H-LPALGR	1.0	25	5.5	140	Green	50	222	.50	12.7	.31	7.9	.012	.03		50	250
MLT2H-LPALGR	2.0	51	7.9	201	Green	50	222	.50	12.7	.31	7.9	.012	.03		50	250
MLT4H-LPALGR	4.0	102	14.3	362	Green	50	222	.50	12.7	.31	7.9	.012	.03		50	250
MLT1H-LPALBU	1.0	25	5.5	140	Blue	50	222	.50	12.7	.31	7.9	.012	.03		50	250
MLT2H-LPALBU	2.0	51	7.9	201	Blue	50	222	.50	12.7	.31	7.9	.012	.03		50	250
MLT4H-LPALBU	4.0	102	14.3	362	Blue	50	222	.50	12.7	.31	7.9	.012	.03		50	250
MLT1H-LPAL	1.0	25	5.5	140	Aluminum	50	222	.50	12.7	.31	7.9	.012	.03		50	250
MLT2H-LPAL	2.0	51	7.9	201	Aluminum	50	222	.50	12.7	.31	7.9	.012	.03		50	250
MLT4H-LPAL	4.0	102	14.3	362	Aluminum	50	222	.50	12.7	.31	7.9	.012	.03		50	250

*Per SAE Standard AS23190/3 (formerly MIL). For additional details, refer to page B3.32.

**For information on installation tools, refer to page B3.15.

PAN-STEEL® Double Wrapped Cable Ties – MLTD Series

- Self-locking head design speeds installation and locks into place at any length along the tie body
- Cable tie body passes through the head two times for additional strength
- Available in heavy, extra-heavy, and super-heavy cross sections
- Available in AISI 304 stainless steel for general-purpose applications
- Available in AISI 316 stainless steel for the most corrosive environments
- Super-heavy double wrapped tested for short circuit applications up to 71.5 kA

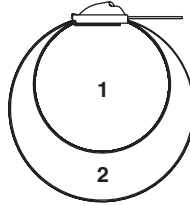
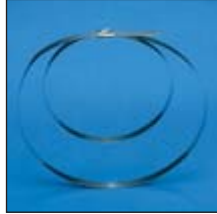

Part Number	Max. Bundle Diameter		Length*		Min. Loop Tensile Strength**		Min. Bundle Diameter		Width		Thickness		Recommended Installation Tool***	Std. Pkg. Qty.	Std. Ctn. Qty.
	In.	mm	In.	mm	Lbs.	N	In.	mm	In.	mm	In.	mm			

AISI 304 Stainless Steel – MLTD Double Wrapped Ties

Heavy Cross Section

MLT2DH-L	2.0	51	18.5	470	600	2670	1.0	25.4	.31	7.9	.010	.25	GS4MT, HTMT, PPTMT, ST2MT	50	250
MLT4DH-L	4.0	102	28.0	711	600	2670	1.0	25.4	.31	7.9	.010	.25		50	250
MLT5DH-L	5.0	127	34.0	863	600	2670	1.0	25.4	.31	7.9	.010	.25		50	250
MLT6DH-Q	6.0	152	40.0	1016	600	2670	1.0	25.4	.31	7.9	.010	.25		25	250

Extra-Heavy Cross Section

MLT4DEH-Q	4.0	102	29.5	749	800	3560	1.0	25.4	.50	12.7	.010	.25	ST2MT, RT1HT, RT1HTN	25	125
MLT6DEH-Q	6.0	152	41.5	1054	800	3560	1.0	25.4	.50	12.7	.010	.25		25	125
MLT8DEH-Q	8.0	203	53.5	1359	800	3560	1.0	25.4	.50	12.7	.010	.25		25	125
MLT4DEH15-Q	4.0	102	29.5	749	1000	4450	1.0	25.4	.50	12.7	.015	.38		25	125
MLT6DEH15-Q	6.0	152	41.5	1054	1000	4450	1.0	25.4	.50	12.7	.015	.38		25	125
MLT8DEH15-Q	8.0	203	53.5	1359	1000	4450	1.0	25.4	.50	12.7	.015	.38		25	125

Super-Heavy Cross Section

MLT4DSH-Q	4.0	102	29.5	749	1200	5340	1.0	25.4	.63	15.9	.015	.38	RT1HT, RT1HTN	25	125
MLT6DSH-Q	6.0	152	41.5	1054	1200	5340	1.0	25.4	.63	15.9	.015	.38		25	125
MLT8DSH-Q	8.0	203	53.5	1359	1200	5340	1.0	25.4	.63	15.9	.015	.38		25	125

AISI 316 Stainless Steel – For MLTD Double Wrapped Ties

Extra-Heavy Cross Section

MLT4DEH-Q316	4.0	102	29.5	749	800	3560	1.0	25.4	.50	12.7	.010	.25	ST2MT, RT1HT, RT1HTN	25	125
MLT6DEH-Q316	6.0	152	41.5	1054	800	3560	1.0	25.4	.50	12.7	.010	.25		25	125
MLT8DEH-Q316	8.0	203	53.5	1359	800	3560	1.0	25.4	.50	12.7	.010	.25		25	125
MLT4DEH15-Q316	4.0	102	29.5	749	1000	4450	1.0	25.4	.50	12.7	.015	.38		25	125
MLT6DEH15-Q316	6.0	152	41.5	1054	1000	4450	1.0	25.4	.50	12.7	.015	.38		25	125
MLT8DEH15-Q316	8.0	203	53.5	1359	1000	4450	1.0	25.4	.50	12.7	.015	.38		25	125

Super-Heavy Cross Section

MLT4DSH-Q316	4.0	102	29.5	749	1200	5340	1.0	25.4	.63	15.9	.015	.38	RT1HT, RT1HTN	25	125
MLT6DSH-Q316	6.0	152	41.5	1054	1200	5340	1.0	25.4	.63	15.9	.015	.38		25	125
MLT8DSH-Q316	8.0	203	53.5	1359	1200	5340	1.0	25.4	.63	15.9	.015	.38		25	125

*Other lengths available, contact PANDUIT Customer Service.

**Per SAE Standard AS23190/3 (formerly MIL). For additional details, refer to page B3.32.

***For information on installation tools, refer to pages B3.14 – B3.16.

A.
System
Overview

B1.
Cable Ties

B2.
Cable
Accessories

B3.
Stainless
Steel Ties

C1.
Wiring
Duct

C2.
Surface
Raceway

C3.
Abrasion
Protection

C4.
Cable
Management

D1.
Terminals

D2.
Power
Connectors

D3.
Grounding
Connectors

E1.
Labeling
Systems

E2.
Labels

E3.
Pre-Printed
& Write-On
Markers

E4.
Permanent
Identification

E5.
Lockout/
Tagout
& Safety
Solutions

F.
Index

A. System Overview

PAN-STEEL® Custom Length Banding – MBS, MBH, MBEH and MBSH Series

B1. Cable Ties

B2. Cable Accessories

B3. Stainless Steel Ties

- For applications that require various bundle diameters
- Supplied in reels of 82.50 feet (25.0m), 200.00 feet (60.9m), 250.00 feet (76.2m) or 1000.00 feet (304.8m)
- Provides job site versatility with minimum inventory
- Packaging speeds removal of steel and includes bundle diameter cut-off guide
- Available in AISI 304 stainless steel for general-purpose applications
- Available in AISI 316 stainless steel for the most corrosive environments

Polyester coating (optional):

- Polyester coating provides additional edge protection and prevents corrosion between dissimilar metals
- UV resistant, low smoke, halogen-free material
- Temperature tolerance -40°F (-40°C) to 302°F (150°C)
- AISI 316 stainless steel for the most corrosive environments

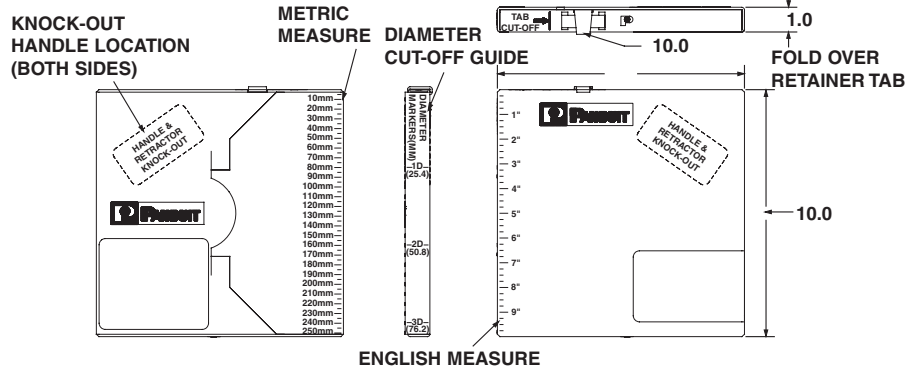

C1. Wiring Duct

C2. Surface Raceway

C3. Abrasion Protection

C4. Cable Management

Part Number	Max. Bundle Diameter		Length*		Min. Loop Tensile Strength**		Min. Bundle Diameter		Width		Thickness^		Recommended Installation Tool***	Recommended Banding Head	Std. Pkg. Qty.‡
	In.	mm	Ft.	M	Lbs.	N	In.	mm	In.	mm	In.	mm			

AISI 304 Stainless Steel — For General Purpose Banding

Standard Cross Section

MBS-TLR	Any	Any	250	76	100	445	.50	12.7	.18	4.4	.010	.25	GS4MT, HTMT, PPTMT, ST2MT	MTHS-C	1
MBS-MR	Any	Any	1000	305	100	445	.50	12.7	.18	4.4	.010	.25		MTHS-C	1

Heavy Cross Section

MBH-TLR	Any	Any	250	76	250	1112	.50	12.7	.31	7.9	.010	.25	GS4MT, HTMT, PPTMT, ST2MT	MTHH-C	1
MBH-MR	Any	Any	1000	305	250	1112	.50	12.7	.31	7.9	.010	.25		MTHH-C	1

Extra-Heavy Cross Section

MBEH-TLR	Any	Any	250	76	300	1335	1.0	25.4	.50	12.7	.010	.25	ST2MT, RT1HT, RT1HTN	MTHEH-C	1
-----------------	-----	-----	-----	----	-----	------	-----	------	-----	------	------	-----	----------------------	---------	---

Super-Heavy Cross Section

MBSH-TR	Any	Any	200	61	450	2000	1.0	25.4	.63	15.9	.015	.38	RT1HT, RT1HTN	MTHSH-C	1
----------------	-----	-----	-----	----	-----	------	-----	------	-----	------	------	-----	---------------	---------	---

D1. Terminals

D2. Power Connectors

D3. Grounding Connectors

E1. Labeling Systems

AISI 316 Stainless Steel — For Superior Corrosion Resistance

Standard Cross Section

MBS-TLR316	Any	Any	250	76	100	445	.50	12.7	.18	4.4	.010	.25	GS4MT, HTMT, PPTMT, ST2MT	MTHS-C316	1
MBS-MR316	Any	Any	1000	305	100	445	.50	12.7	.18	4.4	.010	.25		MTHS-C316	1

Heavy Cross Section

MBH-TLR316	Any	Any	250	76	250	1112	.50	12.7	.31	7.9	.010	.25	GS4MT, HTMT, PPTMT, ST2MT	MTHH-C316	1
MBH-MR316	Any	Any	1000	305	250	1112	.50	12.7	.31	7.9	.010	.25		MTHH-C316	1

Extra-Heavy Cross Section

MBEH-TLR316	Any	Any	250	76	300	1335	1.0	25.4	.50	12.7	.010	.25	ST2MT, RT1HT, RT1HTN	MTHEH-C316	1
--------------------	-----	-----	-----	----	-----	------	-----	------	-----	------	------	-----	----------------------	------------	---

Super-Heavy Cross Section

MBSH-TR316	Any	Any	200	61	450	2000	1.0	25.4	.63	15.9	.015	.38	RT1HT, RT1HTN	MTHSH-C316	1
-------------------	-----	-----	-----	----	-----	------	-----	------	-----	------	------	-----	---------------	------------	---

E2. Labels

E3. Pre-Printed & Write-On Markers

E4. Permanent Identification

E5. Lockout/Tagout & Safety Solutions

Polyester Coated AISI 316 Stainless Steel

Heavy Cross Section

MBCH-QR316	Any	Any	82	25	250	1112	.50	12.7	.31	7.9	.010	.25	GS4MT, HTMT, PPTMT, ST2MT	MTHCH-C316	1
-------------------	-----	-----	----	----	-----	------	-----	------	-----	-----	------	-----	---------------------------	------------	---

*Other lengths available, contact PANDUIT Customer Service.

**Per SAE Standard AS23190/3 (formerly MIL). For additional details, refer to page B3.32.

***For more information on installation tools, refer to pages B3.14 – B3.16.

^Base material less coating.

‡Order in number of reels required.

F. Index

PAN-STEEL® Custom Length Banding – MBS, MBH, MBEH and MBSH Series (continued)

Part Number	Max. Bundle Diameter		Length*		Min. Loop Tensile Strength**		Min. Bundle Diameter		Width		Thickness^		Recommended Installation Tool***	Recommended Banding Head	Std. Pkg. Qty.‡
	In.	mm	Ft.	M	Lbs.	N	In.	mm	In.	mm	In.	mm			
Extra-Heavy Cross Section															
MBCEH-QR316	Any	Any	82	25	300	1335	1.0	25.4	.50	12.7	.010	.25	ST2MT, RT1HT, RT1HTN	MTHCEH-C316	1
Super-Heavy Cross Section															
MBCSH-QR316	Any	Any	82	25	450	2000	1.0	25.4	.63	15.9	.015	.38	RT1HT, RT1HTN	MTHCSH-C316	1

*Other lengths available, contact PANDUIT Customer Service.

**Per SAE Standard AS23190/3 (formerly MIL). For additional details, refer to page B3.32.

***For more information on installation tools, refer to pages B3.14 – B3.16.

^Base material less coating.

‡Order in number of reels required.

To determine the proper amount of banding required, use the following formula:

Calculate S and H Cross Section Diameter inches (mm) x 3.14 + 3 inches (76mm)

Calculate EH and SH Cross Section Diameter inches (mm) x 3.14 + 4.5 inches (114mm)

PAN-STEEL® Custom Length Banding Heads – MTH Series

- Self-locking head design speeds installation and locks into place at any length along the tie body



Part Number	Part Description	Std. Pkg. Qty.	Std. Ctn. Qty.
AISI 304 Stainless Steel			
MTHS-C	Loose piece banding head for standard cross section banding.	100	1000
MTHH-C	Loose piece banding head for heavy cross section banding.	100	1000
MTHEH-C	Loose piece banding head for extra-heavy cross section banding.	100	1000
MTHSH-C	Loose piece banding head for super-heavy cross section banding.	100	1000
AISI 316 Stainless Steel			
MTHS-C316	Loose piece banding head for standard cross section banding.	100	1000
MTHH-C316	Loose piece banding head for heavy cross section banding.	100	1000
MTHEH-C316	Loose piece banding head for extra-heavy cross section banding.	100	1000
MTHSH-C316	Loose piece banding head for super-heavy cross section banding.	100	1000
AISI 316 Coated Stainless Steel			
MTHCH-C316	Loose piece coated banding head for heavy cross section banding.	100	1000
MTHCEH-C316	Loose piece coated banding head for extra-heavy cross section banding.	100	1000
MTHCSH-C316	Loose piece coated banding head for super-heavy cross section banding.	100	1000

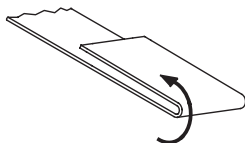

1) Take one end of the cut banding and bend back 1/2" (13mm).

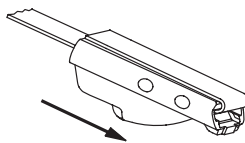

2) Take a self-locking head and slide it the entire length of the band until it reaches the bend.

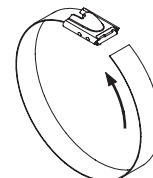

3) Bend tail flat against bottom of banding head to complete assembly.

A. System Overview

GS4MT Hand Operated Installation Tool

B1. Cable Ties

- Single handle operation for fast installation
- Cable tie side entry for immediate positioning of tie and tool
- Controlled tension, fully adjustable
- Easy removal of excess tie

- Qualified product listed per MIL Standard MS90387-3
- Automatically tensions and cuts off tie when predetermined tension is reached
- Installs standard .18 inch (4.6mm), light-heavy .25 inch (6.4mm) and heavy .31 inch (7.9mm) cross section ties

B2. Cable Accessories

B3. Stainless Steel Ties



GS4MT

Part Number	Part Description	Std. Pkg. Qty.
GS4MT	Used with standard, light-heavy, and heavy cross section <i>PAN-STEEL</i> ® type MLT ties, type MLTC/MLTFC coated ties, and type MLTDH double wrapped ties.	1
K4M-BLD	Replacement cutter blade for GS4MT.	1
K4MTG	Replacement tension gripper for GS4MT.	1
CAMT	Cut-off accessory. Use this accessory with GS4MT tool to cut MBH or MBS continuous banding. Accessory drops in place for use.	1

C1. Wiring Duct

C2. Surface Raceway

C3. Abrasion Protection

C4. Cable Management



Side Entry



CAMT

D1. Terminals

D2. Power Connectors

Tool Tension Locking Kits

- For applications requiring a locking device on either the selector knob (one cross section size and tension only) or tension level adjustment (but allow cross section size changes)

D3. Grounding Connectors

E1. Labeling Systems



E2. Labels

To lock selector knob and tension level.

E3. Pre-Printed & Write-On Markers

E4. Permanent Identification



E5. Lockout/Tagout & Safety Solutions

To lock fine adjustment.

F. Index

Part Number	Part Description	Std. Pkg. Qty.
TTLK3	Tool tension locking kit for GS4MT and PPTMT installation tools.	1

ST2MT Installation Tool

- Cable tie side entry for immediate positioning of tie and tool
- One hand operation – lightweight
- Easy removal of excess tie



- Tool tension is controlled by installer – twist action cut-off
- Rugged, lightweight, easy-to-operate pliers-type tool provides mechanical advantage

Part Number	Part Description	Std. Pkg. Qty.
ST2MT	Used with standard, light-heavy, heavy and extra-heavy cross section <i>PAN-STEEL</i> ® type MLT ties, type MLTC/MLTFC coated ties, and type MLTDH double wrapped ties.	1

RT1HT and RT1HTN Installation Tools

- Cable tie side entry for immediate positioning of tie and tool
- One or two hand tensioning with multi-position rear handle
- Adjustable tension control
- Lever actuated cut-off



RT1HT



RT1HTN

- Easy removal of excess tie
- Ratchet style tool for high tension
- Narrow nose tool design option available for applications requiring installations in tight confined spaces

Part Number	Part Description	Std. Pkg. Qty.
RT1HT	Used with extra-heavy .50" (12.7mm) and super-heavy .63" (15.9mm) cross section <i>PAN-STEEL</i> ® type MLT and MLTFC ties. Width of tool nose 2.60" (66.0mm).	1
RT1HTN	Narrow nose installation tool for use with extra-heavy .50" (12.7mm) and super-heavy .63" (15.9mm) cross section <i>PAN-STEEL</i> ® type MLT and MLTFC ties. Width of tool nose 1.06" (27.0mm).	1

HTMT Installation Tool

- Economical
- Coiled tie end remaining after tensioning assures a safe end



- Manual tension, no cut-off
- Installs ties parallel to the bundle

Part Number	Part Description	Std. Pkg. Qty.
HTMT	Used with standard, light-heavy, and heavy cross section <i>PAN-STEEL</i> ® type MLT ties, type MLTC/MLTFC coated ties, and type MLTDH double wrapped ties.	1

A.
System
Overview

B1.
Cable Ties

B2.
Cable
Accessories

B3.
Stainless
Steel Ties

C1.
Wiring
Duct

C2.
Surface
Raceway

C3.
Abrasion
Protection

C4.
Cable
Management

D1.
Terminals

D2.
Power
Connectors

D3.
Grounding
Connectors

E1.
Labeling
Systems

E2.
Labels

E3.
Pre-Printed
& Write-On
Markers

E4.
Permanent
Identification

E5.
Lockout/
Tagout
& Safety
Solutions

F.
Index

A. System Overview

PPTMT Pneumatic Installation Tool

B1. Cable Ties

- Power assisted tool for fast and effortless installation
- Cable tie side entry for immediate positioning of tie and tool
- Controlled tension, fully adjustable
- Automatic cut-off
- One hand operation – lightweight
- Easy removal of excess tie
- Operates 85 PSI (586 KPA Bar) non-lubricated air and requires no special maintenance

B2. Cable Accessories

B3. Stainless Steel Ties



PPTMT

C1. Wiring Duct

C2. Surface Raceway

C3. Abrasion Protection

C4. Cable Management



Side Entry

D1. Terminals

D2. Power Connectors

D3. Grounding Connectors

E1. Labeling Systems

E2. Labels

E3. Pre-Printed & Write-On Markers

E4. Permanent Identification

E5. Lockout/Tagout & Safety Solutions

F. Index

Part Number	Part Description	Std. Pkg. Qty.
PPTMT	Pneumatic hand tool used with <i>PAN-STEEL</i> type MLT ties, type MLTC/MLTFC coated ties, and type MLTDH double wrapped ties. Automatically tensions and cuts off tie when predetermined tension is reached, providing more reliable and consistent installations. Ideal for high production applications. Installs standard .18" (4.6mm), light-heavy .25" (6.4mm), and heavy .31" (7.9mm) cross section ties.	1
PPH10	10.0' (3m) hose assembly (regulator to tool); includes a .13" (3.3mm) NPT male connector (to regulator) and .13" (3.3mm) female quick disconnect (to tool).	1
PL289N1	Filter/regulator .5 micron element, regulated range 3 – 100 psig, features .13" (3.3mm) NPT female output port (to hose PPH10) and .25" (6.4mm) male quick disconnect to source air line.	1
KPPTMTG	Replacement gripper kit for PPTMT.	1
KPPTMTB	Replacement blade kit for PPTMT.	1

Adjustment Features for PPTMT and GS4MT Tools*

Fast and Easy Selection



The cross section of the cable tie being installed is clearly indicated on the knob. To change, simply flip knob to proper cross section indicator.

Tension Indicator



Each cross section of cable ties can be installed with a variety of tensions to meet the application. The proper tensions (listed on *PANDUIT* cable tie packages) are clearly marked with this indicator.

To Change the Tension:



Turn clockwise to increase.



Turn counterclockwise to decrease.

*For information on GS4MT installation tool, refer to page B3.14.

Features and Benefits – PAN-STEEL® Retained Tension Ties – MRT/MRS Series

PANDUIT® PAN-STEEL® Retained Tension Ties are engineered for safety, productivity, and durability by providing round edges and smooth surfaces, easy threading, high loop tensile strength and tight clamping.

PANDUIT Retained Tension Tie Technology

Features of Retained Tension Ties (MRT and MRS Series)*

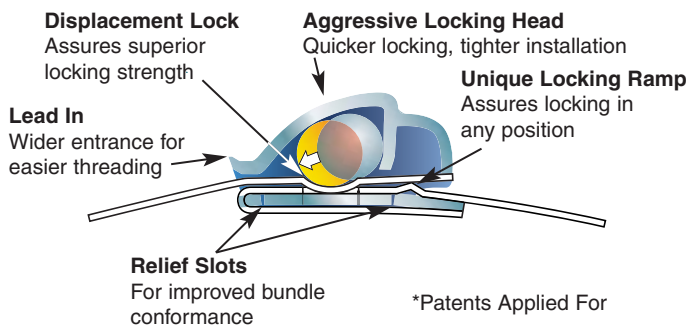

Additional Features of 360° Radial Seal Retained Tension Ties (MRS Series Only)*

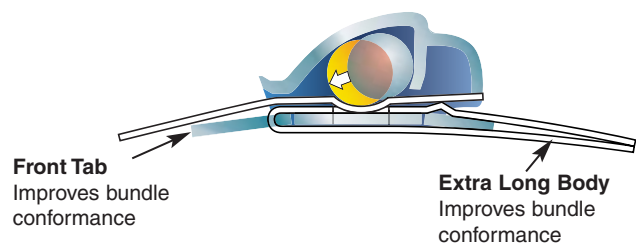

Retained Tension Performance Comparison**

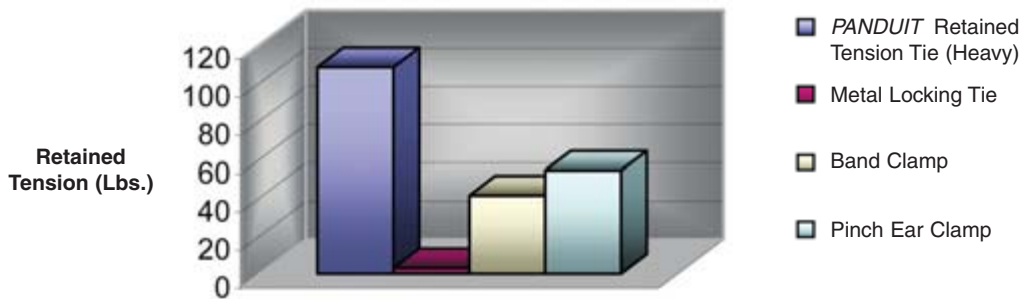

**Representative sample, actual results may vary.

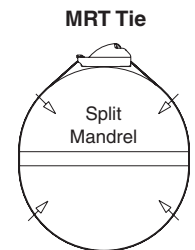

Retained Tension
Split mandrel test fixture measures retained tension of installed tie

A. System Overview

B1. Cable Ties

B2. Cable Accessories

B3. Stainless Steel Ties

C1. Wiring Duct

C2. Surface Raceway

C3. Abrasion Protection

C4. Cable Management

D1. Terminals

D2. Power Connectors

D3. Grounding Connectors

E1. Labeling Systems

E2. Labels

E3. Pre-Printed & Write-On Markers

E4. Permanent Identification

E5. Lockout/Tagout & Safety Solutions

F. Index

Part Number System for PAN-STEEL® Retained Tension Ties – MRT Series

MRT

Type

MRT = Metal Retained Tension Tie

6

Bundle Diameter Reference (In.)

S

Cross Section

S = Standard
LH = Light-Heavy
H = Heavy

—

C

Package Qty.

L = 50
C = 100

4

Material

4 = 304
6 = 316

NEW!

PAN-STEEL® Retained Tension Ties – MRT Series

- Provide tight bundling of armored cables, pipes, conduit and other rigid materials in harsh conditions for a reliable, easy to install fastening solution
- Self-locking cable tie design locks into place at any length along the tie body, unlike fixed diameter band clamps
- Smooth surfaces and rounded edges assures cable protection and worker safety
- Available in AISI 304 stainless steel for general-purpose applications
- Available in AISI 316 stainless steel for the most corrosive environments



Part Number	Max. Bundle Diameter		Length		Min. Loop Tensile Strength		Min. Bundle Diameter		Width		Thickness		Tool*	Std. Pkg. Qty.	Std. Ctn. Qty.
	In.	mm	In.	mm	Lbs.	N	In.	mm	In.	mm	In.	mm			
AISI 304 Stainless Steel – For General Purpose															
Standard Cross Section															
MRT1S-C4	1.0	25	8.1	205	180	800	.75	19.1	.18	4.4	.010	.25	MTRTLS	100	500
MRT2S-C4	2.0	51	11.3	287	180	800	.75	19.1	.18	4.4	.010	.25		100	500
MRT4S-C4	4.0	102	17.6	447	180	800	.75	19.1	.18	4.4	.010	.25		100	500
MRT6S-C4	6.0	152	23.8	604	180	800	.75	19.1	.18	4.4	.010	.25		100	500
Light-Heavy Cross Section															
MRT1.5LH-L4	1.5	38	9.7	246	225	1000	1.00	25.4	.25	6.4	.010	.25	MTRTLS	50	250
MRT2LH-L4	2.0	51	11.3	287	225	1000	1.00	25.4	.25	6.4	.010	.25		50	250
MRT4LH-L4	4.0	102	17.6	447	225	1000	1.00	25.4	.25	6.4	.010	.25		50	250
MRT6LH-L4	6.0	152	23.8	604	225	1000	1.00	25.4	.25	6.4	.010	.25		50	250
Heavy Cross Section															
MRT1.5H-L4	1.5	38	9.7	246	400	1780	1.00	25.4	.31	7.9	.010	.25	MTRTH	50	250
MRT2H-L4	2.0	51	11.3	287	400	1780	1.00	25.4	.31	7.9	.010	.25		50	250
MRT4H-L4	4.0	102	17.6	447	400	1780	1.00	25.4	.31	7.9	.010	.25		50	250
MRT6H-L4	6.0	152	23.8	604	400	1780	1.00	25.4	.31	7.9	.010	.25		50	250
AISI 316 Stainless Steel – For Superior Corrosion Resistance															
Standard Cross Section															
MRT1S-C6	1.0	25	8.1	205	180	800	.75	19.1	.18	4.4	.010	.25	MTRTLS	100	500
MRT2S-C6	2.0	51	11.3	287	180	800	.75	19.1	.18	4.4	.010	.25		100	500
MRT4S-C6	4.0	102	17.6	447	180	800	.75	19.1	.18	4.4	.010	.25		100	500
MRT6S-C6	6.0	152	23.8	604	180	800	.75	19.1	.18	4.4	.010	.25		100	500
Light-Heavy Cross Section															
MRT1.5LH-L6	1.5	38	9.7	246	225	1000	1.00	25.4	.25	6.4	.010	.25	MTRTLS	50	250
MRT2LH-L6	2.0	51	11.3	287	225	1000	1.00	25.4	.25	6.4	.010	.25		50	250
MRT4LH-L6	4.0	102	17.6	447	225	1000	1.00	25.4	.25	6.4	.010	.25		50	250
MRT6LH-L6	6.0	152	23.8	604	225	1000	1.00	25.4	.25	6.4	.010	.25		50	250
Heavy Cross Section															
MRT1.5H-L6	1.5	38	9.7	246	400	1780	1.00	25.4	.31	7.9	.010	.25	MTRTH	50	250
MRT2H-L6	2.0	51	11.3	287	400	1780	1.00	25.4	.31	7.9	.010	.25		50	250
MRT4H-L6	4.0	102	17.6	447	400	1780	1.00	25.4	.31	7.9	.010	.25		50	250
MRT6H-L6	6.0	152	23.8	604	400	1780	1.00	25.4	.31	7.9	.010	.25		50	250

*Note: MRT ties for use with MTRT tools only.

Part Number System for PAN-STEEL® 360° Radial Seal Retained Tension Ties – MRS Series

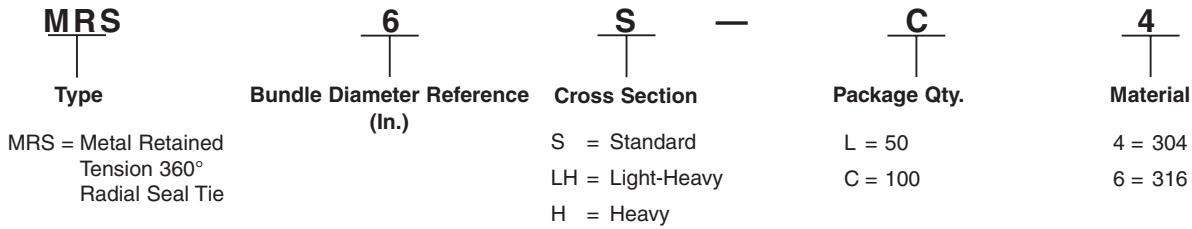

PAN-STEEL® 360° Radial Seal Retained Tension Ties – MRS Series



- 360° radial seal eliminates gaps under the head of the tie to provide a completely sealed installation
- Self-locking cable tie design locks into place at any length along the tie body, unlike fixed diameter band clamps
- Available in AISI 304 stainless steel for general-purpose applications
- Available in AISI 316 stainless steel for the most corrosive environments



Part Number	Max. Bundle Diameter		Length		Min. Loop Tensile Strength		Min. Bundle Diameter		Width		Thickness		Tool*	Std. Pkg. Qty.	Std. Ctn. Qty.
	In.	mm	In.	mm	Lbs.	N	In.	mm	In.	mm	In.	mm			
AISI 304 Stainless Steel – For General Purpose															
MRS1S-C4	1.0	25	8.1	205	180	800	.75	19.1	.18	4.4	.010	.25	MTRTLS	100	500
MRS2S-C4	2.0	51	11.3	287	180	800	.75	19.1	.18	4.4	.010	.25		100	500
MRS4S-C4	4.0	102	17.6	447	180	800	.75	19.1	.18	4.4	.010	.25		100	500
MRS6S-C4	6.0	152	23.8	604	180	800	.75	19.1	.18	4.4	.010	.25		100	500
Light-Heavy Cross Section															
MRS1.5LH-L4	1.5	38	9.7	246	225	1000	1.00	25.4	.25	6.4	.010	.25	MTRTLS	50	250
MRS2LH-L4	2.0	51	11.3	287	225	1000	1.00	25.4	.25	6.4	.010	.25		50	250
MRS4LH-L4	4.0	102	17.6	447	225	1000	1.00	25.4	.25	6.4	.010	.25		50	250
MRS6LH-L4	6.0	152	23.8	604	225	1000	1.00	25.4	.25	6.4	.010	.25		50	250
Heavy Cross Section															
MRS1.5H-L4	1.5	38	9.7	246	400	1780	1.00	25.4	.31	7.9	.010	.25	MTRTH	50	250
MRS2H-L4	2.0	51	11.3	287	400	1780	1.00	25.4	.31	7.9	.010	.25		50	250
MRS4H-L4	4.0	102	17.6	447	400	1780	1.00	25.4	.31	7.9	.010	.25		50	250
MRS6H-L4	6.0	152	23.8	604	400	1780	1.00	25.4	.31	7.9	.010	.25		50	250
AISI 316 Stainless Steel – For Superior Corrosion Resistance															
Standard Cross Section															
MRS1S-C6	1.0	25	8.1	205	180	800	.75	19.1	.18	4.4	.010	.25	MTRTLS	100	500
MRS2S-C6	2.0	51	11.3	287	180	800	.75	19.1	.18	4.4	.010	.25		100	500
MRS4S-C6	4.0	102	17.6	447	180	800	.75	19.1	.18	4.4	.010	.25		100	500
MRS6S-C6	6.0	152	23.8	604	180	800	.75	19.1	.18	4.4	.010	.25		100	500
Light-Heavy Cross Section															
MRS1.5LH-L6	1.5	38	9.7	246	225	1000	1.00	25.4	.25	6.4	.010	.25	MTRTLS	50	250
MRS2LH-L6	2.0	51	11.3	287	225	1000	1.00	25.4	.25	6.4	.010	.25		50	250
MRS4LH-L6	4.0	102	17.6	447	225	1000	1.00	25.4	.25	6.4	.010	.25		50	250
MRS6LH-L6	6.0	152	23.8	604	225	1000	1.00	25.4	.25	6.4	.010	.25		50	250
Heavy Cross Section															
MRS1.5H-L6	1.5	38	9.7	246	400	1780	1.00	25.4	.31	7.9	.010	.25	MTRTH	50	250
MRS2H-L6	2.0	51	11.3	287	400	1780	1.00	25.4	.31	7.9	.010	.25		50	250
MRS4H-L6	4.0	102	17.6	447	400	1780	1.00	25.4	.31	7.9	.010	.25		50	250
MRS6H-L6	6.0	152	23.8	604	400	1780	1.00	25.4	.31	7.9	.010	.25		50	250

*Note: MRS ties for use with MTRT tools only.

A. System Overview

B1. Cable Ties

B2. Cable Accessories

B3. Stainless Steel Ties

C1. Wiring Duct

C2. Surface Raceway

C3. Abrasion Protection

C4. Cable Management

D1. Terminals

D2. Power Connectors

D3. Grounding Connectors

E1. Labeling Systems

E2. Labels

E3. Pre-Printed & Write-On Markers

E4. Permanent Identification

E5. Lockout/Tagout & Safety Solutions

F. Index



Retained Tension Installation Tools

- Adjustable detent mechanism provides user pre-set controlled tension for repeatable installations and maximum reliability
- Smooth cable tie cut-off eliminates burrs or sharp edges after installation to deliver added bundle protection and job site safety

- Tie tensioning mechanism provides improved durability compared to conventional gripper style tools
- Change over kits available to allow for installation of all tie cross sections with one tool

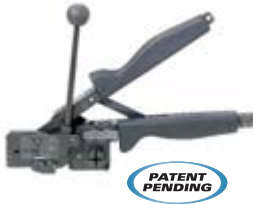

Part Number	Part Description	Std. Pkg. Qty.
MTRTH	Retained tension installation tool for use with <i>PAN-STEEL</i> ® heavy cross section MRT and MRS style ties.	1
MTRTLS	Retained tension installation tool for use with <i>PAN-STEEL</i> ® light-heavy and standard cross section MRT and MRS style ties.	1
KMTRTH	Change over kits allow for installation of heavy cross section MRT and MRS style ties in MTRTLS tools.	1
KMTRTLS	Change over kits allow for installation of light-heavy and standard cross section MRT and MRS style ties in MTRTH tools.	1

Note: For high volume applications, contact *PANDUIT* Customer Service.

MRT/MRS Installation Steps



1) Place retained tension tie around material, insert tail of tie through metal locking head. Pull tie tight by hand.



2) Insert tail of retained tension tie into nose of tool tensioning slot.



3) Squeeze tension handle until preset tension is reached.



4) Grasp tension handle lever and move forward, setting ball and cutting tie.



5) Remove tool, installation complete. Provides safe, flush cut-off.

Features and Benefits – PAN-STEEL® Strapping System

The PANDUIT® PAN-STEEL® Stainless Steel Strapping is the ultimate solution for strapping applications. The buckle design and tension controlled installation tool offer a quick and safe installation for all harsh environments. Available in three widths 3/8" (9.5mm), 1/2" (12.7mm) and 5/8" (15.9mm) in base 304 or 316 stainless steel with a temperature range of -112°F (-80°C) to 1000°F (538°C).

Unique Locking Method*

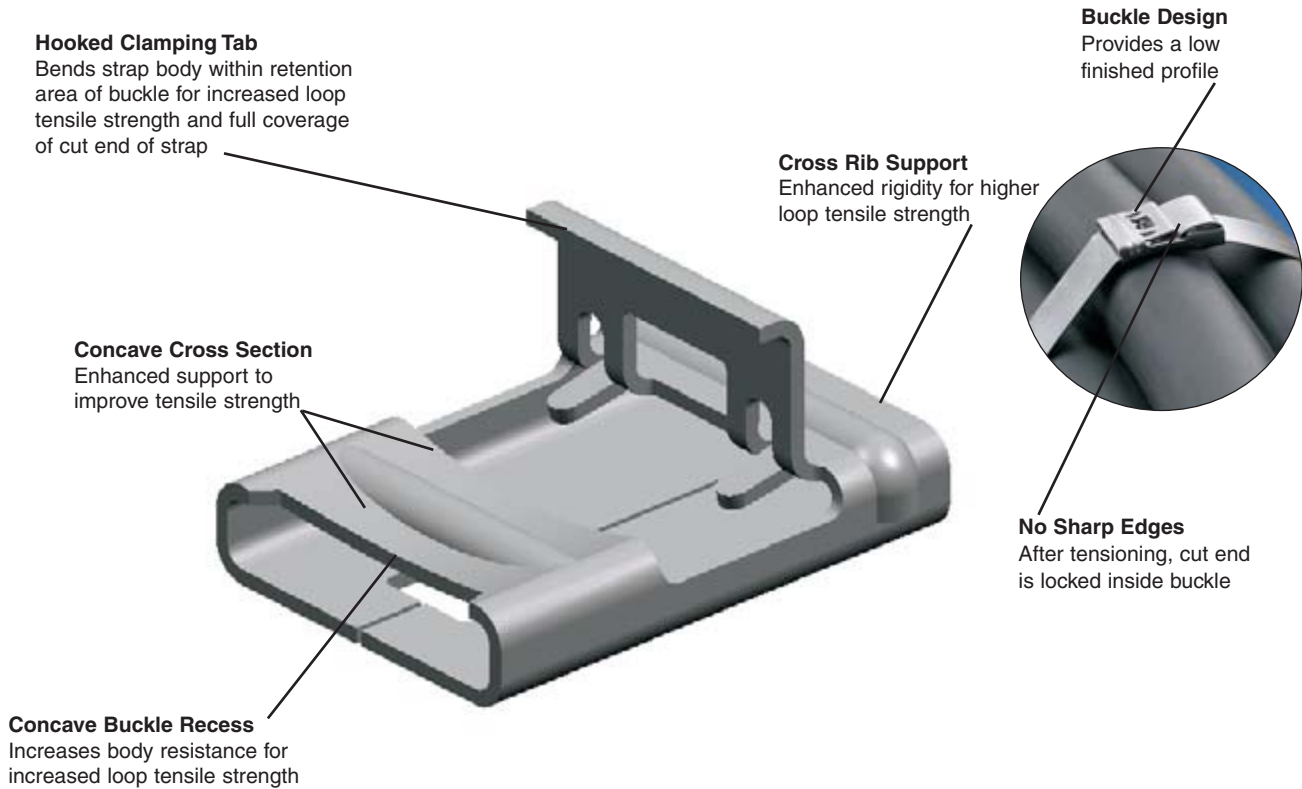

*Patents applied for



Hand operated installation tool used with all widths of PANDUIT® PAN-STEEL® Strapping. Tensions, cuts strapping, and secures the buckle tab. Easy to operate. See page B3.26.



Custom length strapping available for applications that require various bundle diameters, to provide job safety and versatility with minimum inventory. See page B3.25.

A.
System
Overview

B1.
Cable Ties

B2.
Cable
Accessories

B3.
Stainless
Steel Ties

C1.
Wiring
Duct

C2.
Surface
Raceway

C3.
Abrasion
Protection

C4.
Cable
Management

D1.
Terminals

D2.
Power
Connectors

D3.
Grounding
Connectors

E1.
Labeling
Systems

E2.
Labels

E3.
Pre-Printed
& Write-On
Markers

E4.
Permanent
Identification

E5.
Lockout/
Tagout
& Safety
Solutions

F.
Index

A. System Overview

The PANDUIT Method Reduces Installation Time

B1. Cable Ties

B2. Cable Accessories

B3. Stainless Steel Ties



1) Place strap around the material, insert tail of strap through buckle. Pull strapping tight and bend up to hold in place. Insert tail of strapping into tool nose section. Squeeze handle to tension.



2) Once proper tension is reached, maintain tension and raise tool 90° – 120° over buckle and pull down on cutter lever, cutting strap.



3) Remove tool, press cut end down and toward retaining tab.

C1. Wiring Duct

C2. Surface Raceway

C3. Abrasion Protection

C4. Cable Management



4) Using the closure lever on the handle of the tool, bend retaining tab down and over cut end. Provides finished, safe, low profile closure.

D1. Terminals

D2. Power Connectors

D3. Grounding Connectors

E1. Labeling Systems

Part Number System for Discrete Length Strapping

MS	4	W	38	T	15	L	4
Type	Bundle Diameter (In.)	Width	Inches	Thickness	15 = 0.015"	Standard Package Size	Material
MS = Metal Strap C = Coated Blank = Uncoated			38 = 3/8 50 = 1/2 63 = 5/8			L = 50 Pcs.	4 = 304 SS 6 = 316 SS

Part Number System for Coil Strapping

MS	W	50	T	15	CR	6
Type	Width	Inches	Thickness	15 = 0.015"	Standard Package Size	Material
MS = Metal Strap C = Coated Blank = Uncoated		38 = 3/8 50 = 1/2 63 = 5/8			CR = 100' QR = 825'	4 = 304 SS 6 = 316 SS

Part Number System for Strapping Buckles

MS	B	W	63	C	4
Type	B = Buckle	Width	Inches	Standard Package Size	Material
MS = Metal Strap			38 = 3/8 50 = 1/2 63 = 5/8	C = 100 Pcs.	4 = 304 SS 6 = 316 SS

PAN-STEEL® Strapping – MS Series

- Fold over design provides high-retained tension in mechanical fastening and cable bundling applications
- After tensioning, cut end is locked inside low profile buckle – no sharp edges
- Can be used in a wide range of indoor, outdoor, and underground (including direct burial) applications
- Smooth surfaces and rounded edges assures cable protection and worker safety
- Available in AISI 304 stainless steel for general-purpose applications
- Available in AISI 316 stainless steel for the most corrosive environments



Part Number	Max. Bundle Diameter		Length*		Min. Loop Tensile Strength**		Min. Bundle Diameter		Width		Thickness		Recommended Installation Tool***	Std. Pkg. Qty.	Std. Ctn. Qty.	
	In.	mm	In.	mm	Lbs.	N	In.	mm	In.	mm	In.	mm				
AISI 304 Stainless Steel																
MS2W38T15-L4	2.0	51	11.8	300	500	2225	1.0	25.4	.38	9.5	.015	.38	BT1HT	50	250	
MS4W38T15-L4	4.0	102	18.0	457	500	2225	1.0	25.4	.38	9.5	.015	.38		50	250	
MS6W38T15-L4	6.0	152	24.4	620	500	2225	1.0	25.4	.38	9.5	.015	.38		50	250	
MS8W38T15-L4	8.0	203	30.7	780	500	2225	1.0	25.4	.38	9.5	.015	.38		50	250	
MS10W38T15-L4	10.0	254	37.0	940	500	2225	1.0	25.4	.38	9.5	.015	.38		50	250	
MS4W50T15-L4	4.0	102	18.0	457	700	3115	1.0	25.4	.50	12.7	.015	.38		50	250	
MS6W50T15-L4	6.0	152	24.4	620	700	3115	1.0	25.4	.50	12.7	.015	.38		50	250	
MS8W50T15-L4	8.0	203	30.7	780	700	3115	1.0	25.4	.50	12.7	.015	.38		50	250	
MS10W50T15-L4	10.0	254	37.0	940	700	3115	1.0	25.4	.50	12.7	.015	.38		50	250	
MS4W63T15-L4	4.0	102	18.0	457	800	3560	1.0	25.4	.63	15.9	.015	.38		50	250	
MS6W63T15-L4	6.0	152	24.4	620	800	3560	1.0	25.4	.63	15.9	.015	.38		50	250	
MS8W63T15-L4	8.0	203	30.7	780	800	3560	1.0	25.4	.63	15.9	.015	.38		50	250	
MS10W63T15-L4	10.0	254	37.0	940	800	3560	1.0	25.4	.63	15.9	.015	.38		50	250	
AISI 316 Stainless Steel																
MS2W38T15-L6	2.0	51	11.8	300	500	2225	1.0	25.4	.38	9.5	.015	.38		BT1HT	50	250
MS4W38T15-L6	4.0	102	18.0	457	500	2225	1.0	25.4	.38	9.5	.015	.38	50		250	
MS6W38T15-L6	6.0	152	24.4	620	500	2225	1.0	25.4	.38	9.5	.015	.38	50		250	
MS8W38T15-L6	8.0	203	30.7	780	500	2225	1.0	25.4	.38	9.5	.015	.38	50		250	
MS10W38T15-L6	10.0	254	37.0	940	500	2225	1.0	25.4	.38	9.5	.015	.38	50		250	
MS4W50T15-L6	4.0	102	18.0	457	700	3115	1.0	25.4	.50	12.7	.015	.38	50		250	
MS6W50T15-L6	6.0	152	24.4	620	700	3115	1.0	25.4	.50	12.7	.015	.38	50		250	
MS8W50T15-L6	8.0	203	30.7	780	700	3115	1.0	25.4	.50	12.7	.015	.38	50		250	
MS10W50T15-L6	10.0	254	37.0	940	700	3115	1.0	25.4	.50	12.7	.015	.38	50		250	
MS4W63T15-L6	4.0	102	18.0	457	800	3560	1.0	25.4	.63	15.9	.015	.38	50		250	
MS6W63T15-L6	6.0	152	24.4	620	800	3560	1.0	25.4	.63	15.9	.015	.38	50		250	
MS8W63T15-L6	8.0	203	30.7	780	800	3560	1.0	25.4	.63	15.9	.015	.38	50		250	
MS10W63T15-L6	10.0	254	37.0	940	800	3560	1.0	25.4	.63	15.9	.015	.38	50		250	

*Other lengths available, contact PANDUIT Customer Service.

**Per SAE Standard AS23190/3 (formerly MIL). For additional details, refer to page B3.32.

***For information on installation tool, refer to page B3.26.

A.
System
Overview

B1.
Cable Ties

B2.
Cable
Accessories

B3.
Stainless
Steel Ties

C1.
Wiring
Duct

C2.
Surface
Raceway

C3.
Abrasion
Protection

C4.
Cable
Management

D1.
Terminals

D2.
Power
Connectors

D3.
Grounding
Connectors

E1.
Labeling
Systems

E2.
Labels

E3.
Pre-Printed
& Write-On
Markers

E4.
Permanent
Identification

E5.
Lockout/
Tagout
& Safety
Solutions

F.
Index

A.
System
Overview

PAN-STEEL® Nylon 11 Coated Strapping – MSC Series

B1.
Cable Ties

- Fold over design provides high-retained tension in mechanical fastening and cable bundling applications
- After tensioning, cut end is locked inside low profile buckle – no sharp edges
- AISI 316 stainless steel for the most corrosive environments
- Available in .38 inch (9.5mm), .50 inch (12.7mm), .63 inch (15.9mm) cross sections
- UV resistant, low smoke, halogen-free material
- Temperature tolerance -40°F (-40°C) to 285°F (140°C)

B2.
Cable
Accessories

B3.
Stainless
Steel Ties



C1.
Wiring
Duct

C2.
Surface
Raceway

C3.
Abrasion
Protection

C4.
Cable
Management

D1.
Terminals

D2.
Power
Connectors

D3.
Grounding
Connectors

E1.
Labeling
Systems

E2.
Labels

E3.
Pre-Printed
& Write-On
Markers

E4.
Permanent
Identification

E5.
Lockout/
Tagout/
& Safety
Solutions

F.
Index

Part Number	Max. Bundle Diameter		Length*		Min. Loop Tensile Strength**		Min. Bundle Diameter		Width		Thickness^		Recommended Installation Tool***	Std. Pkg. Qty.	Std. Ctn. Qty.
	In.	mm	In.	mm	Lbs.	N	In.	mm	In.	mm	In.	mm			
MSC2W38T15-L6	2.0	51	11.8	300	300	1335	1.0	25.4	.38	9.5	.015	.38	BT1HT	50	250
MSC4W38T15-L6	4.0	102	18.0	457	300	1335	1.0	25.4	.38	9.5	.015	.38		50	250
MSC6W38T15-L6	6.0	152	24.4	620	300	1335	1.0	25.4	.38	9.5	.015	.38		50	250
MSC8W38T15-L6	8.0	203	30.7	780	300	1335	1.0	25.4	.38	9.5	.015	.38		50	250
MSC10W38T15-L6	10.0	254	37.0	940	300	1335	1.0	25.4	.38	9.5	.015	.38		50	250
MSC4W50T15-L6	4.0	102	18.0	457	500	2225	1.0	25.4	.50	12.7	.015	.38		50	250
MSC6W50T15-L6	6.0	152	24.4	620	500	2225	1.0	25.4	.50	12.7	.015	.38		50	250
MSC8W50T15-L6	8.0	203	30.7	780	500	2225	1.0	25.4	.50	12.7	.015	.38		50	250
MSC10W50T15-L6	10.0	254	37.0	940	500	2225	1.0	25.4	.50	12.7	.015	.38		50	250
MSC4W63T15-L6	4.0	102	18.0	457	800	3560	1.0	25.4	.63	15.9	.015	.38		50	250
MSC6W63T15-L6	6.0	152	24.4	620	800	3560	1.0	25.4	.63	15.9	.015	.38		50	250
MSC8W63T15-L6	8.0	203	30.7	780	800	3560	1.0	25.4	.63	15.9	.015	.38		50	250
MSC10W63T15-L6	10.0	254	37.0	940	800	3560	1.0	25.4	.63	15.9	.015	.38		50	250

*Other lengths available, contact PANDUIT Customer Service.

**Per SAE Standard AS23190/3 (formerly MIL). For additional details, refer to page B3.32.

***For information on installation tools, refer to page B3.26.

^Base material less coating.

PAN-STEEL® Custom Length Strapping

- Fold over design provides high retained tension in mechanical fastening and cable bundling applications
- After tensioning, cut end is locked inside low profile buckle – no sharp edges
- For applications that require various bundle diameters
- Supplied in reels of 82.5 feet (25m) (coated) or 100 feet (30.5m) (uncoated)

- Provides job site versatility with minimum inventory
- Packaging speeds removal of steel and includes bundle diameter cut-off guide
- Available in AISI 304 stainless steel for general-purpose applications
- Available in AISI 316 stainless steel for the most corrosive environments



Nylon 11 coating (optional):

- Nylon 11 coating provides additional edge protection and prevents corrosion between dissimilar metals
- UV resistant, low smoke, halogen-free material
- Temperature tolerance -40°F (-40°C) to 285°F (140°C)
- AISI 316 stainless steel for the most corrosive environments

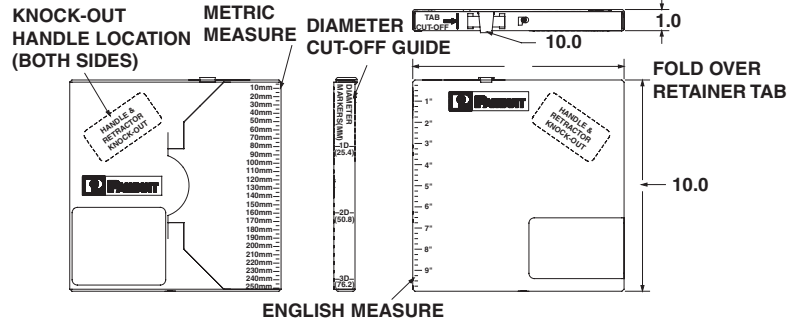

Part Number	Length*		Min. Loop Tensile Strength**		Width		Thickness^		Used with Buckle	Recommended Installation Tool***	Std. Pkg. Qty.‡
	Ft.	M	Lbs.	N	In.	mm	In.	mm			
304 Stainless Steel											
MSW38T15-CR4	100	30.5	500	2225	.38	9.5	.015	.38	MSBW38-C4	BT1HT	1
MSW50T15-CR4	100	30.5	700	3115	.50	12.7	.015	.38	MSBW50-C4		1
MSW63T15-CR4	100	30.5	800	3560	.63	15.9	.015	.38	MSBW63-C4		1
316 Stainless Steel											
MSW38T15-CR6	100	30.5	500	2225	.38	9.5	.015	.38	MSBW38-C6	BT1HT	1
MSW50T15-CR6	100	30.5	700	3115	.50	12.7	.015	.38	MSBW50-C6		1
MSW63T15-CR6	100	30.5	800	3560	.63	15.9	.015	.38	MSBW63-C6		1
Nylon Coated Custom Length Strapping											
MSCNW38T15-QR6	82.5	25	300	1335	.38	9.5	.015	.38	MSBW38-C6	BT1HT	1
MSCNW50T15-QR6	82.5	25	700	3115	.50	12.7	.015	.38	MSBW50-C6		1
MSCNW63T15-QR6	82.5	25	800	3560	.63	15.9	.015	.38	MSBW63-C6		1

*Other lengths available, contact PANDUIT Customer Service.

**Per SAE Standard AS23190/3 (formerly MIL). For additional details, refer to page B3.32.

***For information on installation tools, refer to page B3.26.

^Base metal less coating.

‡Order in number of reels required.

To determine the proper amount of strapping required, use the following formula:

Calculate Diameter inches (mm) x 3.14 + 6 inches (152.4 mm)

PAN-STEEL® Buckles for Custom Length Strapping

- Buckle design provides a low finished profile

- After tensioning cut end is locked inside buckle – no sharp edges

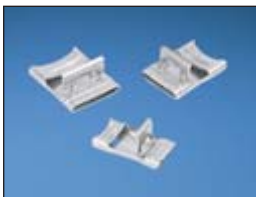

Part Number	Material	Width		Part Description	Std. Pkg. Qty.	Std. Ctn. Qty.
		In.	mm			
AISI 304 Stainless Steel						
MSBW38-C4	304	.38	9.5	Individual low profile buckles used with custom length strapping.	100	1000
MSBW50-C4	304	.50	12.7		100	1000
MSBW63-C4	304	.63	15.9		100	1000
AISI 316 Stainless Steel						
MSBW38-C6	316	.38	9.5	Individual low profile buckles used with custom length strapping.	100	1000
MSBW50-C6	316	.50	12.7		100	1000
MSBW63-C6	316	.63	15.9		100	1000

A.
System
Overview

BT1HT Hand Operated Installation Tool for Strapping

B1.
Cable Ties

- Strap side entry
- One or two hand tensioning with multi-position rear handle
- Adjustable tension control

- Lever actuated cut-off
- Easy removal of excess strap
- Installs all three sizes: .38 inch (9.5mm), .50 inch (12.7mm), and .63 inch (15.9mm)



B2.
Cable
Accessories

B3.
Stainless
Steel Ties

Part Number	Part Description	Std. Pkg. Qty.
BT1HT	Used for all widths of <i>PANDUIT® PAN-STEEL®</i> Strapping. Tensions, cuts strapping, and secures the buckle tab. Ratchet-type tool provides mechanical advantage for tensioning. Easy to operate.	1

C1.
Wiring
Duct

C2.
Surface
Raceway

C3.
Abrasion
Protection

PCS Cushion Sleeve

C4.
Cable
Management

- Black neoprene sleeving used with *PAN-STEEL®* Stainless Steel Ties, custom length banding, and MS strap
- Used on applications requiring improved gripping on non-resilient objects
- Can be used indoors or outdoors (excellent ultraviolet resistance, good resistance to petroleum, and many chemicals)

- Isolation between dissimilar metals allows the ties and straps to be used with aluminum cable tray
- Provides full separation between the ties and the bundle
- Operating temperature range -40°F (-40°C) to 200°F (93°C)

D1.
Terminals

D2.
Power
Connectors



D3.
Grounding
Connectors

Part Number	Used with <i>PAN-STEEL®</i> Ties/Strapping	Width		Length		Std. Pkg. Qty‡
		In.	mm	Ft.	m	
PCSS-B-CR	MLT/S	.33	8.4	100	30.5	1
PCSH-B-CR	MLT/LH/H	.47	11.9	100	30.5	1
PCSSH-B-CR*	MLT/EH/SH and MS Straps	.91	23.1	100	30.5	1

*Meets MIL-R-6855

‡Order in number of reels required.

Bulk Pkg. -CR = 100' (30.5m) reel.

E1.
Labeling
Systems



E2.
Labels

E3.
Pre-Printed
& Write-On
Markers

E4.
Permanent
Identification

E5.
Lockout/
Tagout
& Safety
Solutions

F.
Index

Stainless Steel Tie Mounts

- Low profile
- One hole mounting

- For use with standard, light-heavy, and heavy cross section *PAN-STEEL*® Ties as well as .38 inch (9.5mm) wide strapping
- 304 Stainless Steel

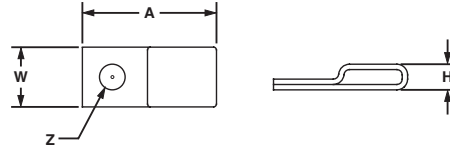
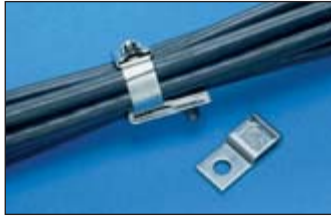

Part Number	Used with <i>PAN-STEEL</i> ® Ties/Strapping	Mounting Method*	Length A		Width W		Height H		Hole Diameter Z		Std. Pkg. Qty.	Std. Ctn. Qty.
			In.	mm	In.	mm	In.	mm	In.	mm		
MTM1H-C	MLTS/LH/H, MLTC/H, MLTFC/S/LH/H or MSW38	#8 (4mm) screw	.90	22.6	.40	10.2	.17	4.4	.17	4.4	100	1000
MTM1H10-C		#10 (5mm) screw	.90	22.6	.40	10.2	.17	4.4	.21	5.4	100	1000
MTM1H25-C		1/4" (6mm) screw	.90	22.6	.40	10.2	.17	4.4	.28	7.1	100	1000

*Stainless steel screws are recommended for fastening to avoid corrosion problems associated with dissimilar metals.

Stainless Steel Push Mount

- No tapping required
- Used where only one side of the panel is accessible
- Nothing to assemble

- For use with standard, light-heavy, and heavy cross section *PAN-STEEL*® Ties
- 304 Stainless Steel



PATENT PENDING

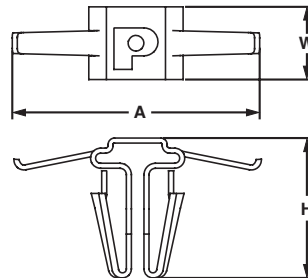

Part Number	Used with <i>PAN-STEEL</i> ® Ties/Strapping	Mounting Method	Length A		Width W		Height H		Panel Thickness		Std. Pkg. Qty.	Std. Ctn. Qty.
			In.	mm	In.	mm	In.	mm	In.	mm		
MPWM-H56-Q	MLTS/LH/H, MLTC/H or MLTFC/S/LH/H	Inserted into pre-drilled hole 5/16" (8mm)	.98	24.7	.29	7.3	.56	14.2	.03 – .09	.8 – 2.4	25	250

A. System Overview

B1. Cable Ties

B2. Cable Accessories

B3. Stainless Steel Ties

C1. Wiring Duct

C2. Surface Raceway

C3. Abrasion Protection

C4. Cable Management

D1. Terminals

D2. Power Connectors

D3. Grounding Connectors

E1. Labeling Systems

E2. Labels

E3. Pre-Printed & Write-On Markers

E4. Permanent Identification

E5. Lockout/Tagout & Safety Solutions

F. Index

A. System Overview

Stainless Steel Push Button Mount

B1. Cable Ties

- Low profile
- No tapping required
- Designed for use only where both sides of the panel are accessible

- For use with standard cross section *PAN-STEEL*® Ties
- 304 Stainless Steel

B2. Cable Accessories

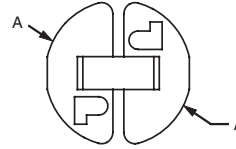
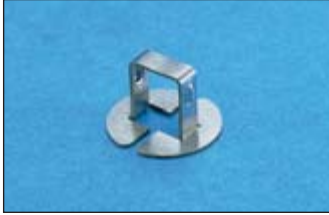

B3. Stainless Steel Ties

C1. Wiring Duct

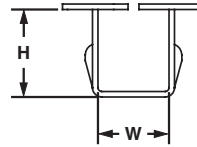

C2. Surface Raceway

C3. Abrasion Protection

Part Number	Used with <i>PAN-STEEL</i> ® Ties/Strapping	Mounting Method	Diameter A		Width W		Height H		Panel Thickness		Std. Pkg. Qty.	Std. Ctn. Qty.
			In.	mm	In.	mm	In.	mm	In.	mm		
MBM-H25-Q	MLT/S or MLTFC/S	Inserted into pre-drilled hole .25" (6.4mm)	.40	10.0	.20	5.0	.26	6.5	.03 – .12	.8 – 3.0	25	250

C4. Cable Management

D1. Terminals

Stainless Steel 2-Way Tie Mount

D2. Power Connectors

- Allows stainless steel cable ties to be inserted from either of two sides
- Low profile
- Single hole center mounting for maximum holding and stability
- Maximum screw head height .09 inches (2.3mm)

- For use with standard, light-heavy, and heavy cross section *PAN-STEEL*® Ties
- 304 Stainless Steel

D3. Grounding Connectors

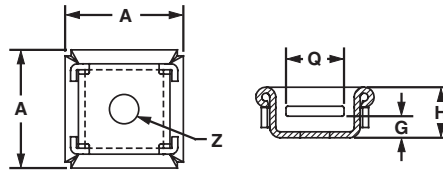

E1. Labeling Systems

E2. Labels

E3. Pre-Printed & Write-On Markers

Part Number	Used with <i>PAN-STEEL</i> ® Ties/Strapping	Mounting Method*	Length A		Height H		Screw Head Height G		Slot Width Q		Hole Diameter Z		Std. Pkg. Qty.	Std. Ctn. Qty.
			In.	mm	In.	mm	In.	mm	In.	mm	In.	mm		
MTM2H-Q	MLTS/LH/H, MLTC/H or MLTFC/S/LH/H	#8 (4mm) screw	.71	18.0	.30	8.0	.09	2.3	.35	9.0	.17	4.5	25	250

E4. Permanent Identification

E5. Lockout/Tagout & Safety Solutions

F. Index

*Stainless steel screws are recommended for fastening to avoid corrosion problems associated with dissimilar metals.

Stainless Steel Bulkhead Mount

- Zero profile
- Mounts directly to surface
- Used where only one side of the panel is accessible

- Permanent, secure application
- Used with standard, light-heavy, and heavy cross section *PAN-STEEL®* Ties
- 304 Stainless Steel

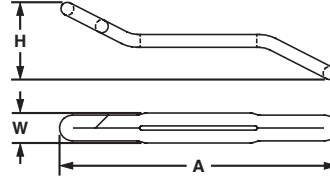

Part Number	Used with <i>PAN-STEEL®</i> Ties/Strapping	Mounting Method	Length A		Width W		Height H		Max. Panel Thickness		Std. Pkg. Qty.	Std. Ctn. Qty.
			In.	mm	In.	mm	In.	mm	In.	mm		
MTMBH-Q	MLTS/LH/H/EH/SH, MLTC/H, or MLTFC/S/LH/H/EH/SH	Pre-drill hole size standard and light-heavy cross section MLT-S/LH .38" (9.5mm) – .50" (12.7mm). Heavy cross section MLT-H .50" (12.7mm) – .63" (15.9mm).	1.92	48.5	.21	5.3	.54	13.7	.50	12.7	25	250

To Install Bulkhead Mount:

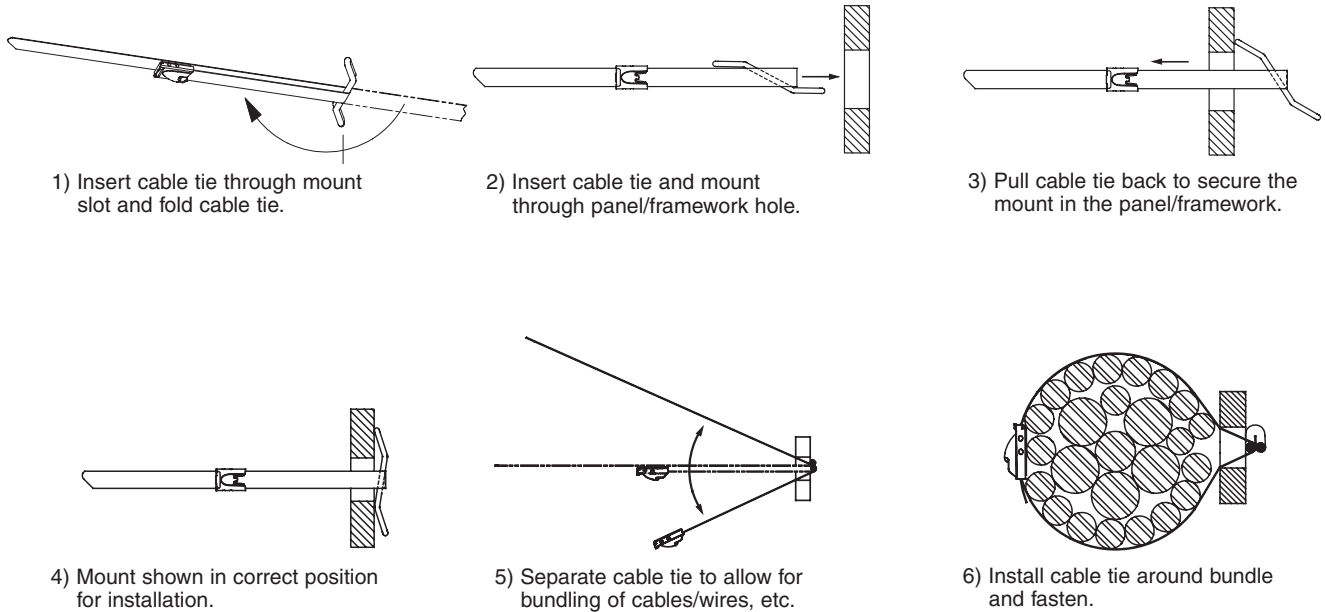

1) Insert cable tie through mount slot and fold cable tie.

2) Insert cable tie and mount through panel/framework hole.

3) Pull cable tie back to secure the mount in the panel/framework.

4) Mount shown in correct position for installation.

5) Separate cable tie to allow for bundling of cables/wires, etc.

6) Install cable tie around bundle and fasten.

A. System Overview

B1. Cable Ties

B2. Cable Accessories

B3. Stainless Steel Ties

C1. Wiring Duct

C2. Surface Raceway

C3. Abrasion Protection

C4. Cable Management

D1. Terminals

D2. Power Connectors

D3. Grounding Connectors

E1. Labeling Systems

E2. Labels

E3. Pre-Printed & Write-On Markers

E4. Permanent Identification

E5. Lockout/Tagout & Safety Solutions

F. Index

A. System Overview

Stainless Steel Technical Information

Physical Characteristics of Stainless Steel and Aluminum

B1. Cable Ties

B2. Cable Accessories

B3. Stainless Steel Ties

	PAN-STEEL® Stainless Steel Marker Plates, Tags, and Cable Ties	PAN-ALUM™ Aluminum Marker Plates and Cable Ties
Material:	304 and 316 Grade Stainless Steel	Aluminum – Natural and Anodized
Maximum temperature rating:	538°C (1000°F)	100°C (212°F)
Minimum temperature rating:	-80°C (-112°F)	-80°C (-112°F)
RoHS:	Compliant	Compliant
Flammability:	Non-flammable	Non-flammable
Ultraviolet light resistance:	Excellent	Good



C1. Wiring Duct

PANDUIT Stainless Steel Cable Tie and Strapping Approvals

C2. Surface Raceway

C3. Abrasion Protection

C4. Cable Management

D1. Terminals

D2. Power Connectors

D3. Grounding Connectors

E1. Labeling Systems

E2. Labels

E3. Pre-Printed & Write-On Markers

E4. Permanent Identification

E5. Lockout/Tagout & Safety Solutions

F. Index

Logo (Symbol)	Agency	Spec /Approval	Requirement	Applicable Products
	Underwriters Laboratories, Inc.	Listing E56854	Dimensional, tensile, temp., cycling, humidity	MLT-S, MLT-LH, MLT-H, MLTEH15, MLTSH, MLTDEH and MLTDSH in 304, and 316. MSW38T15, MSW50T15, MSW63T15, MSBW38, MSBW50, MSBW63 in both 304 and 316 material. MSCW38T15, MSCW50T15, MSCW63T15, MSCNW38T15, MLTFCS, SH, MLTCH, MSCNW50T15, and MSW63T15 in 316 material
	Conformite European	Low Voltage Directive 73/23/EEC (amended 93/68/EEC) MLT cable ties and MS straps also meet the requirements from EN50146	CE Marking is required for products sold within the European Union. CE Marking Directives specify the minimum performance of these products. Applying the CE mark signifies compliance with essential requirements of specific directives.	All MLT, MRT, MRS ties and MS straps
	Amer. Bureau of Shipping	Cert. #03-HS373867-PDA, 04-HS476898-PDA, 05-HS118592C/1-PDA, 06-HS152579-PDA, 05-HS118592A/2-PDA	Mechanical	All MLT ties and MS straps
	Bureau Veritas	Cert. #04048/D2 BV	Material specification, dimensional, visual	All uncoated MLT ties in 304 and 316 material
	Det Norske Veritas	Cert. # E-6540 E-6539	Salt mist test, tensile test, accelerated aging, vibration tests	All uncoated MLTS, MLTH, MLTE15, MLTDEH15, MLTSH, and MS strap coated and uncoated 316 material
	Germanischer Lloyd	Cert. # 32666-83HH 51796-89HH	Mechanical	All uncoated stainless steel MLT ties and all MS straps
	Lloyd's Register of Shipping	Cert. # 89/60123	Material specification, tensile test, vibration tests	All uncoated stainless steel MLT ties and all MS straps
	RINA	Cert. # ELE71502CS	Material specification	All uncoated stainless steel MLT ties and all MS straps
	SAE Int'l formerly US MIL	AS23190 formerly MS23109E	Dimensional, visual, vibration, temp. cycling, immersion	MLT-S and MLT-H ties in 304 and 306 material
	US Coast Guard	File No.16703/46	Mechanical	MLT-H series cable ties
	US Military	MIL-T-81306A/ MS90387-3	Mechanical	GS4MT installation tools

Chemical Resistance at 70°F (21°C) Temperature

Chemical	%	304 & 316 Stainless Steel*	Chemical	%	304 & 316 Stainless Steel*	Chemical	%	304 & 316 Stainless Steel*	Chemical	%	304 & 316 Stainless Steel*
Arsenic Acid	40	E	Cider		E	Methyl Alcohol	100	E	Sodium Bisulfate	10	E
Acetone	100	E	Di-chloroethane	100	E	Methyl Chloride	100	E	Sodium Borate	All	E
Aluminum Hydroxide	AQ C.S.	E	Diethyl Ether	100	E	Methyl Ethyl Ketone	100	E	Sodium Carbonate	5	E
Ammonium Carbonate	5	E	Ethyl Alcohol	100	E	Naphtha	100	E	Sodium Chlorate	25	E
Ammonium Hydroxide	10	E	Ethyl Chloride	100	E	Nitric Acid	30-70	E	Sodium Chloride	2	E
Ammonium Nitrate		E	Ethyl Glycol	100	E	Nitrous Acid	5	E	Sodium Fluoride	5	F
Ammonium Sulfate	10	S	Ferric Hydroxide	All	E	Oleic Acid	100	E	Sodium Hydroxide	10	E
Barium Carbonate	All	E	Ferric Nitrate	10	E	Oxalic Acid	10	E	Sodium Hyposulfite	AQ C.S.	E
Barium Chloride	5	E	Ferrous Sulfate	10	E	Paraffin	100	E	Sodium Nitrate	5	E
Barium Sulfate	10	E	Fuel Oil	100	E	Petroleum Ether	100	E	Sodium Nitrite	AQ C.S.	E
Barium Sulfide	10	E	Furfural	100	E	Phenol	90	E	Sodium Perchlorate	10	E
Benzene	100	E	Gallic Acid	AQ C.S.	E	Phosphoric Acid	10	E	Sodium Phosphate	5	E
Benzoic Acid	100	E	Gasoline	100	E	Picric Acid	1	S	Sodium Sulfate	5	E
Butyric Acid	50	E	Glycerine	100	E	Potassium Bromide	AQ C.S.	S	Sodium Thiosulfate	5	S
Calcium Carbonate	AQ C.S.	E	Hydrocyanic Acid	All	E	Potassium Carbonate 1%		E	Stearic Acid	100	E
Calcium Chlorate	10	E	Hydrogen Peroxide	30	E	Potassium Chlorate	AQ C.S.	E	Sulfur	100	E
Calcium Hydroxide	20	E	Hydrogen Sulfide	Dry	E	Potassium Dichromate	40	E	Sulfur Dioxide	All	E
Calcium Hydrochlorite	2	F	Idoform	100	E	Potassium Ferrocyanide	25	E	Sulfuric Acid	100	E
Calcium Sulfate	2	E	Isopropyl Alcohol	100	E	Potassium hydroxide	5	E	Sulfuric Acid	5	F
Carbon Tetrachloride			Jet Fuel	100	E	Potassium Iodide	All	E	Tannic Acid	10	E
Chlorine (Wet)		F	Lactic Acid	100	E	Potassium Nitrate	50	E	Tartaric Acid	50	E
Chlorine (Dry)		F	Lanolin	10	E	Potassium Permanganate	5	E	Tetrahydrofuran	100	E
Chloroacetic Acid	30	F	Lead Acetate	5	E	Potassium Sulfate	5	E	Toluene	100	F
Chloroform	100	E	Magnesium Carbonate	All	E	Potassium Sulfide	AQ C.S.	E	Xylene	100	E
Chromic Acid	5	E	Magnesium Chloride	10	F	Propyl Alcohol	100	E	Zinc Chloride	70	E
Citric Acid	50	E	Magnesium Nitrate	All	E	Silver Nitrate	10	E	Zinc Nitrate	AQ C.S.	E
Copper Cyanide	10	E	Malic Acid	AQ C.S.	E	Sodium Acetate	60	E	Zinc Sulfate	AQ C.S.	E
Copper Nitrate	50	E	Mercury	100	E	Sodium Bicarbonate	All	E			

* E = Excellent S = Satisfactory F = Fair AQ C.S. = Aqueous Cold Saturated All = All % Concentrations

A.
System
Overview

B1.
Cable Ties

B2.
Cable
Accessories

B3.
Stainless
Steel Ties

C1.
Wiring
Duct

C2.
Surface
Raceway

C3.
Abrasion
Protection

C4.
Cable
Management

D1.
Terminals

D2.
Power
Connectors

D3.
Grounding
Connectors

E1.
Labeling
Systems

E2.
Labels

E3.
Pre-Printed
& Write-On
Markers

E4.
Permanent
Identification

E5.
Lockout/
Tagout
& Safety
Solutions

F.
Index

A.
System
Overview

Rigorous Tests and Physical Properties of Stainless Steel

B1.
Cable Ties

STRENGTH: *PANDUIT® PAN-STEEL®* Stainless Steel Ties and Straps are tested per the SAE Standard AS23190 formerly U.S. Military Specification MIL-S-23190, minimum loop tensile test. This test consists of applying a tie to a split mandrel and then measuring the force required to separate the (two) halves until the tie fails. These minimum loop tensile strengths are given for the various products on pages B3.5 through B3.25.



B2.
Cable
Accessories

TEMPERATURE EXTREMES: *PANDUIT® PAN-STEEL®* Stainless Steel Ties and Straps are 100% stainless steel in the alloy provided (locking head, locking ball, and body all provided from the same grade of material ordered).

Various temperature tests have been successfully completed. One such test is the U.S. Military Temperature Cycling Test per Thermal Shock Method 107, Test Condition B of MIL-STD-202. This test exposes the parts from low temperature 85°F (-65°C) to high temperature 275°F (135°C) to low temperature -85°F (-65°C). After exposure, the parts must be free of cracks, distortions, breaks, release of locking device; and meet the minimum loop tensile requirements.

B3.
Stainless
Steel Ties

SHOCK AND VIBRATION: *PANDUIT® PAN-STEEL®* Standard and Heavy Cross Section ties have passed the U.S. Military random vibration Test Method 214. Test Condition II, Letter J of MIL-STD-202. This test consists of applying parts to a bundle and then vibrating them with random vibration for 8 hours in each of two mutually perpendicular directions. The parts are then subjected to further temperature testing and finally have to pass the minimum loop tensile strength test.

PANDUIT® PAN-STEEL® Extra Heavy, Super Heavy, MSW50 Strapping and MSW63 Strapping have passed the U.S. Military Shock and Vibration Testing per MIL-STD-167 and MIL-S-901D. The ties were subjected to vibrations in all three planes from 4 – 50 Hz and Shock testing in all three planes utilizing a hammer shock machine.

C1.
Wiring
Duct

C2.
Surface
Raceway

SALT SPRAY: *PANDUIT® PAN-STEEL®* Stainless Steel Ties and Straps have been subjected to salt spray tests without signs of corrosion or reduction in performance.

OUTDOOR EXPOSURE: *PANDUIT® PAN-STEEL®* Stainless Steel Ties and Straps have been exposed outdoors at New Lenox, Illinois USA since 1985. At the printing of this catalog, there has been no sign of corrosion or loss of performance.

C3.
Abrasion
Protection

C4.
Cable
Management

FLUID IMMERSION: *PANDUIT® PAN-STEEL®* Stainless Steel Ties were immersed in: 1-Hydraulic Fluid, 2-Turbine Fuel, 3-Lubricating Oil, and 4-Isopropyl Alcohol for four hours at temperatures of 122°F (50°C). Per SAE Standard AS23190, the parts were then subjected to and passed the minimum loop tensile test.

RADIATION: Installed cable ties of various materials have been exposed to different amounts of radiation to determine the maximum acceptable limit. These tests were conducted by *PANDUIT* to determine the acceptability for use in various areas of nuclear power plants (accumulated over 40 year life). Radiation resistance is 2x10⁸ rads.

D1.
Terminals

D2.
Power
Connectors

D3.
Grounding
Connectors

E1.
Labeling
Systems

E2.
Labels

E3.
Pre-Printed
& Write-On
Markers

E4.
Permanent
Identification

E5.
Lockout/
Tagout
& Safety
Solutions

F.
Index

Military Cross Reference (AS23190)

Current Military Standard Part Number	<i>PANDUIT</i> Part Number
M23190/3-1	MLT2S-CP
M23190/3-1	MLT2S-CP316
M23190/3-2	MLT4S-CP
M23190/3-2	MLT4S-CP316
M23190/3-3	MLT6S-CP
M23190/3-3	MLT6S-CP316
M23190/3-4	MLT8S-CP
M23190/3-4	MLT8S-CP316
M23190/3-5	MLT2H-LP
M23190/3-5	MLT2H-LP316
M23190/3-6	MLT4H-LP
M23190/3-6	MLT4H-LP316
M23190/3-7	MLT6H-LP
M23190/3-7	MLT6H-LP316
M23190/3-8	MLT8H-LP
M23190/3-8	MLT8H-LP316
M23190/3-9	MLT10H-LP
M23190/3-9	MLT10H-LP316

WIRING DUCT

From the smallest wall mounted panels to the largest integrated turnkey systems *PANDUIT® PANDUCT®* Wiring Duct is the premium wire management solution for routing and concealing wiring in electrical control panels. *PANDUCT®* Wiring Duct provide solutions for the original equipment manufacturing, transportation, contract manufacturing, maintenance and repair and communications markets. All *PANDUCT®* Wiring Duct are UL Recognized and CSA Certified and most carry the CE mark.

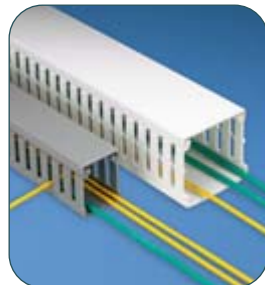
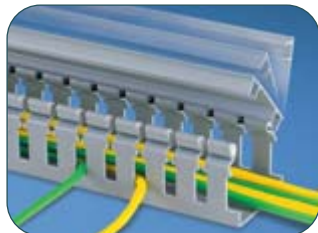

Some of the features and benefits found in *PANDUCT®* Wiring Duct include:

- Smooth corners and edges that will not abrade wiring or irritate hands
- Integrated nonskid liners and unique cover designs insure the duct cover will not slide once installed or during vibration
- Specially formulated lead-free PVC material meets the NFPA79: 2007 flame retardancy requirements and carries a UL 94V-0 flammability rating
- Scorelines for easy removal of duct fingers and sidewalls
- Accessories and tools that increase productivity and lower the installed cost

PANDUIT continues to develop new *PANDUCT®* Wiring Duct solutions to satisfy the challenges facing our customers worldwide. The new type HN hinged cover wiring duct features narrow slots for excellent high-density wire management. Plus the exclusive hinged cover provides convenient channel access resulting in up to 20% faster wiring changes for reduced labor costs. Maximize the utilization of enclosure space with *PANELMAX™* Corner Wiring Duct, which fits into the corner of enclosures and provides up to five square feet of additional subpanel space for mounting control components or up to 20% savings in enclosure footprint area.

A.
System
Overview

B1.
Cable Ties

B2.
Cable
Accessories

B3.
Stainless
Steel Ties

C1.
Wiring
Duct

C2.
Surface
Raceway

C3.
Abrasion
Protection

C4.
Cable
Management

D1.
Terminals

D2.
Power
Connectors

D3.
Grounding
Connectors

E1.
Labeling
Systems

E2.
Labels

E3.
Pre-Printed
& Write-On
Markers

E4.
Permanent
Identification

E5.
Lockout/
Tagout
& Safety
Solutions

F.
Index

A.
System
Overview

Wiring Duct for Control Panel Applications

B1.
Cable Ties

B2.
Cable
Accessories

B3.
Stainless
Steel Ties

C1.
Wiring
Duct

C2.
Surface
Raceway

C3.
Abrasion
Protection

C4.
Cable
Management

D1.
Terminals

D2.
Power
Connectors

D3.
Grounding
Connectors

E1.
Labeling
Systems

E2.
Labels

E3.
Pre-Printed
& Write-On
Markers

E4.
Permanent
Identification

E5.
Lockout/
Tagout/
& Safety
Solutions

F.
Index

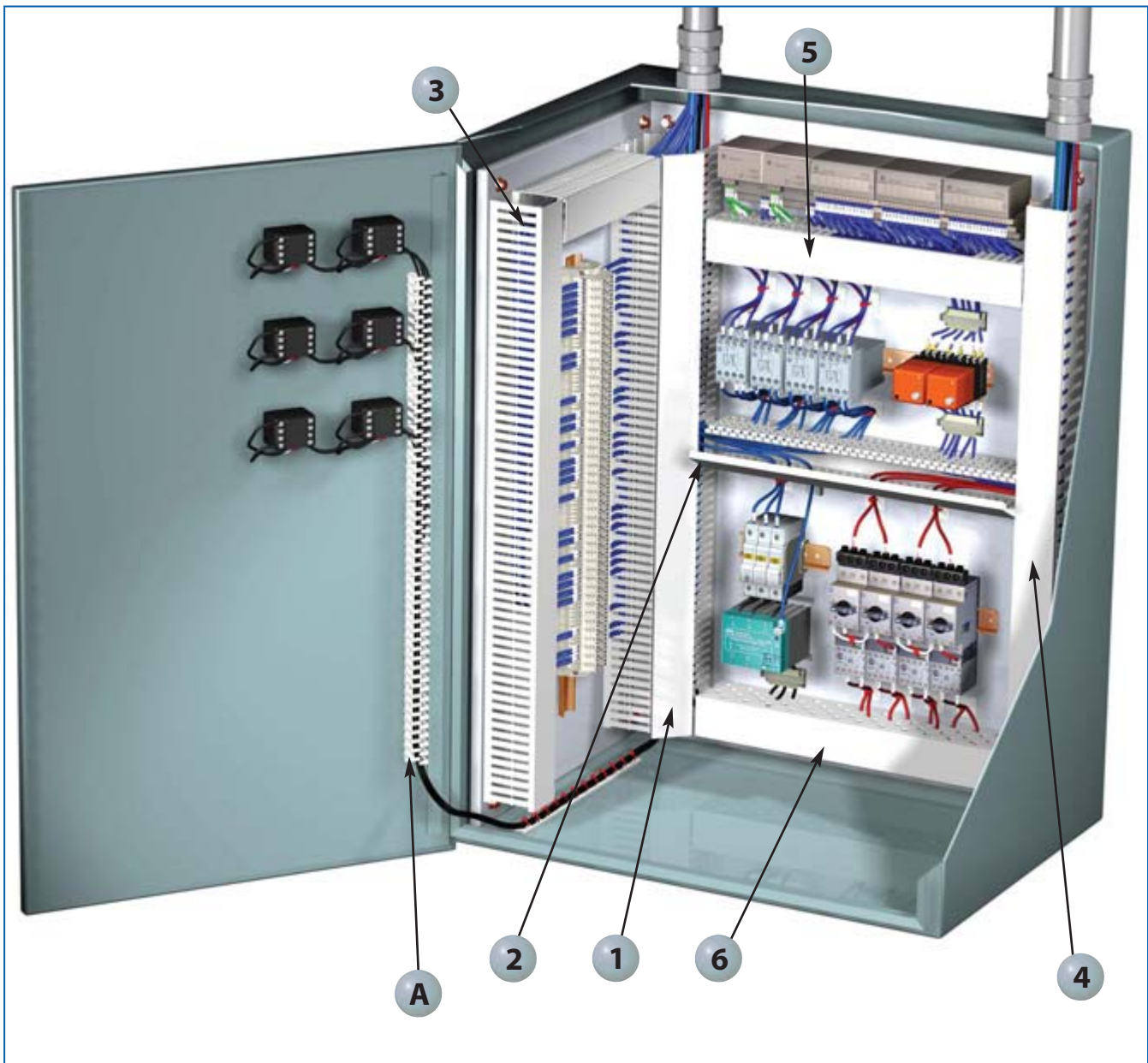

A

For information on FL Wiring Duct and other *PANDUIT®* Accessories see pages C1.25 – C1.32

1 *PANDUCT® PANELMAX™* Corner Wiring Duct
(pages C1.4 – C1.5)



2 *PANDUCT®* Type H Wide Slot and
HN Narrow Slot Hinged Cover Wiring Duct
(pages C1.6 – C1.7)

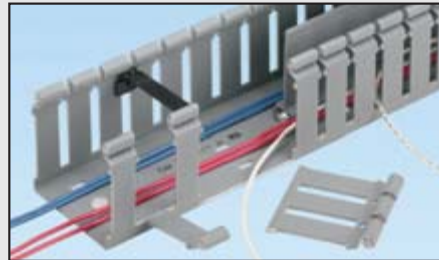

3 *PANDUCT®* Type F Narrow Slot Wiring Duct
(pages C1.10 – C1.11)

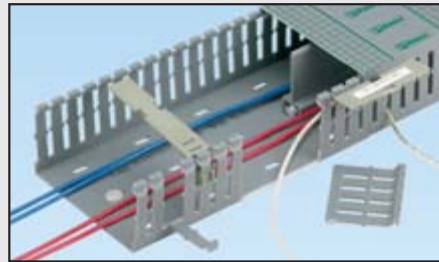

4 *PANDUCT®* Type G Wide Slot Wiring Duct
(pages C1.8 – C1.9)

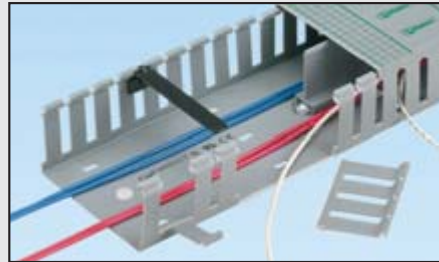

5 *PANDUCT®* Type MC Metric Wiring Duct
(pages C1.14 – C1.15)

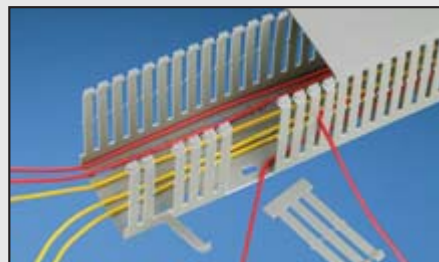

6 *PANDUCT®* Type D Flush Cover Round Hole
Wiring Duct (pages C1.12 – C1.13)

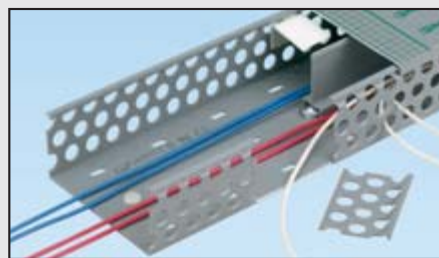

A.
System
Overview

B1.
Cable Ties

B2.
Cable
Accessories

B3.
Stainless
Steel Ties

C1.
Wiring
Duct

C2.
Surface
Raceway

C3.
Abrasion
Protection

C4.
Cable
Management

D1.
Terminals

D2.
Power
Connectors

D3.
Grounding
Connectors

E1.
Labeling
Systems

E2.
Labels

E3.
Pre-Printed
& Write-On
Markers

E4.
Permanent
Identification

E5.
Lockout/
Tagout
& Safety
Solutions

F.
Index

A. System Overview

Features and Benefits – PANDUCT® PANELMAX™ Corner Wiring Duct

B1. Cable Ties

B2. Cable Accessories

B3. Stainless Steel Ties

C1. Wiring Duct

C2. Surface Raceway

C3. Abrasion Protection

C4. Cable Management

D1. Terminals

D2. Power Connectors

D3. Grounding Connectors

E1. Labeling Systems

E2. Labels

E3. Pre-Printed & Write-On Markers

E4. Permanent Identification

E5. Lockout/Tagout & Safety Solutions

F. Index

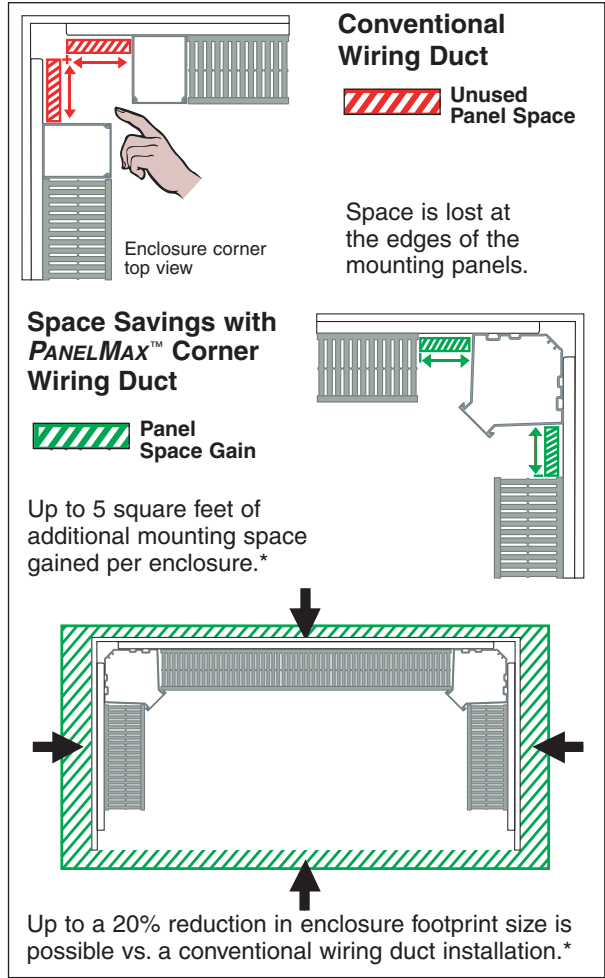
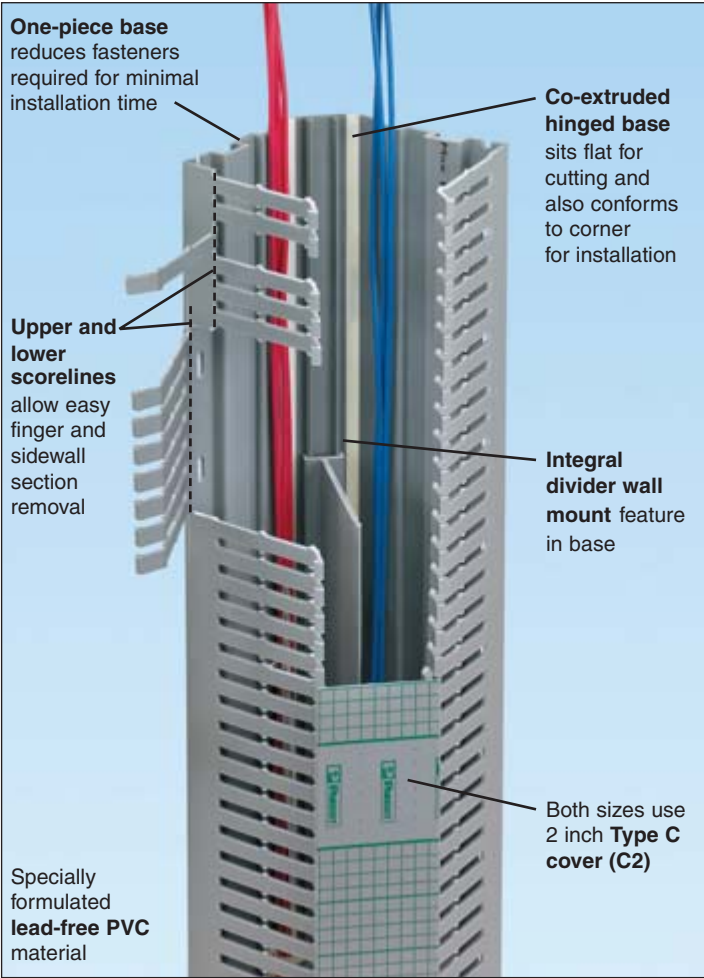

PANDUCT® Nylon Rivets
Fast, lowest cost mounting method.
See page C1.34.



PANDUCT® Installation Tools
Wide selection of hand tools for cutting and installing wiring duct.
See page C1.34.

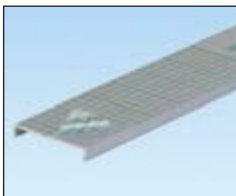

PANDUCT® Type C Cover with Protective Film
Reduces scrap and labor costs by protecting the surface during storage, handling, and installation.
See page C1.5.



PANDUCT® Divider Wall
Creates separate wiring channels within the wiring duct base. Available in solid or slotted wall styles.
See page C1.26.

*Actual subpanel space savings will vary depending on wiring duct size, component layout, and enclosure size and type. Footprint savings is based on commercially available enclosures and may not be achievable in some applications.

UL® CE PANELMAX™ Corner Wiring Duct



- Fits in the unused space in the vertical corner of enclosures, gaining subpanel space or saving enclosure footprint area
- One-piece base requires less time to install than multi-piece solutions
- Optional quick mount clips engage anywhere along the product base further reducing assembly costs

- PANDUIT divider wall snaps directly to the integrated mounting feature in the channel to create two separate channels
- Compatible with PANDUIT 3 inch and 4 inch height wiring duct; both product sizes uses standard 2 inch wiring duct cover
- Base and cover length is 6 feet



Base Part Number	Duct Size W x H (In.)	Slot Width		Cover Part Number	Std. Pkg. Qty.	Base Ctn. Qty.	Cover Ctn. Qty.
		In.	mm				
CWD3LG6	4.40 x 3.57	.20	5.0	C2LG6	6	24	120
CWD4LG6	5.33 x 4.58	.20	5.0	C2LG6	6	24	120
CWD3WH6	4.40 x 3.57	.20	5.0	C2WH6	6	24	120
CWD4WH6	5.33 x 4.58	.20	5.0	C2WH6	6	24	120

Part number shown in LG (Light Gray) color, also available in WH (White) color. Product available in 6' lengths.

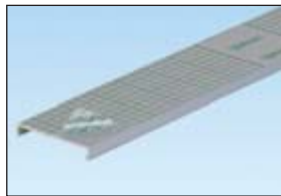
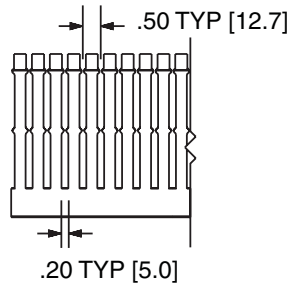
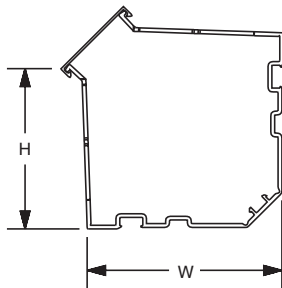

To order cover with protective film add "-F" to part number. 6" inch cover not available with protective film.



CDLB



CDCLP

Part Number	Part Description	Fastener Size	Std. Pkg. Qty.	Std. Ctn. Qty.
Quick Mount Clips				
CDLB3	L-bracket with quick mounting clip for installing CWD3 to back panel only.	#10-32 x 1/4 (user supplied)	16	—
CDLB4	L-bracket with quick mounting clip for installing CWD4 to back panel only.	#10-32 x 1/4 (user supplied)	16	—
CDCLP3	Quick mounting clip for installing CWD3 corner wiring duct.	#10-32 x 1/4 (user supplied)	16	—
CDCLP4	Quick mounting clip for installing CWD4 corner wiring duct.	#10-32 x 1/4 (user supplied)	16	—

A. System Overview

B1. Cable Ties

B2. Cable Accessories

B3. Stainless Steel Ties

C1. Wiring Duct

C2. Surface Raceway

C3. Abrasion Protection

C4. Cable Management

D1. Terminals

D2. Power Connectors

D3. Grounding Connectors

E1. Labeling Systems

E2. Labels

E3. Pre-Printed & Write-On Markers

E4. Permanent Identification

E5. Lockout/Tagout & Safety Solutions

F. Index

A. System Overview

Features and Benefits – PANDUCT® Type H and HN Hinged Cover Wiring Duct

Available in eight sizes from 1.5" x 2" up to 4" x 4" in light gray, black, and white colors.

B1. Cable Ties

B2. Cable Accessories

B3. Stainless Steel Ties

C1. Wiring Duct

C2. Surface Raceway

C3. Abrasion Protection

C4. Cable Management

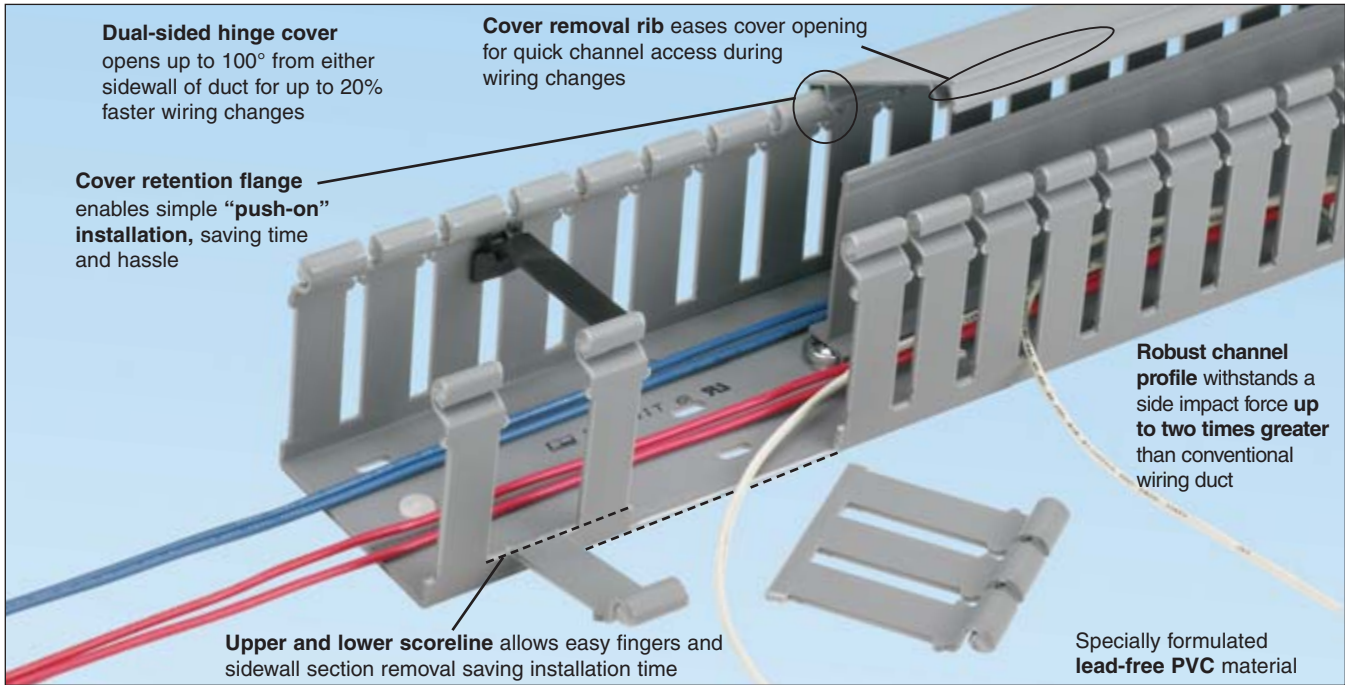

D1. Terminals

Labor Savings

- By avoiding the time and hassle in removing and replacing covers, simple wiring changes can be made up to **20% faster** compared to conventional wiring duct installations*

D2. Power Connectors

Avoid Cover Replacement Costs

- Covers represent 20% of the cost of the wiring duct purchase
- Misplaced covers are a common occurrence after years of use
- Not needing to remove covers during maintenance ensures **better aesthetics and safety** and **avoids the cost to replace lost covers**

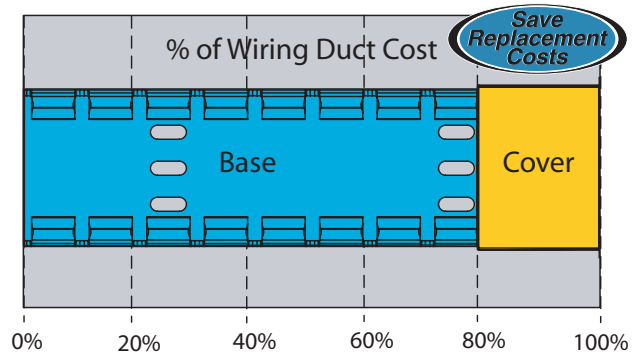

D3. Grounding Connectors

E1. Labeling Systems

E2. Labels

E3. Pre-Printed & Write-On Markers

E4. Permanent Identification

E5. Lockout/Tagout & Safety Solutions

F. Index



PANDUCT® Wire Retainers
Contain wiring when duct cover is opened. Wire retainers snap easily between duct fingers. See page C1.28.



PANDUCT® Divider Wall
Create separate wiring channels within the wiring duct base. Available in solid or slotted wall styles. See page C1.26.



PANDUCT® Installation Tools
Wide selection of hand tools for cutting and installing wiring duct. See page C1.34.



PANDUCT® Nylon Rivets
Fast, lowest cost mounting method. See page C1.34.

*Based on mock panel installations of type H hinged cover wiring duct and other commonly available wiring ducts adding a single component with four wires.



UL **PANDUCT® Type HN Hinged Cover Narrow Slot Wiring Duct**

- Narrow slot/finger design provides excellent wire management with smaller wire diameters and high-density components such as terminal blocks, input/output devices, and other hardware
- Material: Lead-free PVC
- UL Recognized continuous use temperature: 122°F (50°C)
- UL 94 flammability rating of V-0
- Conforms with NFPA 79-2007 section 13.3.1 requirement for flame retardant material
- Provided with mounting holes
- Base and cover length is 6 feet

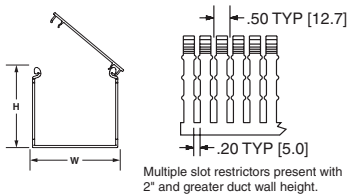
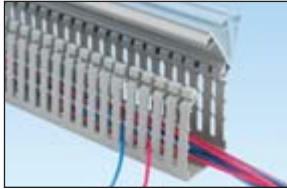

Base Part Number	Duct Size W x H*		Slot Width		Cover Part Number	Std. Pkg. Qty.	Base Ctn. Qty.	Cover Ctn. Qty.
	In.	mm	In.	mm				
HN1.5X2LG6	1.75 x 1.98	44.5 x 50.3	.20	5.0	HC1.5LG6	6	120	120
HN1.5X3LG6	1.75 x 3.06	44.5 x 77.7	.20	5.0	HC1.5LG6	6	120	120
HN2X2LG6	2.17 x 1.98	55.1 x 50.3	.20	5.0	HC2LG6	6	120	120
HN2X3LG6	2.17 x 3.06	55.1 x 77.7	.20	5.0	HC2LG6	6	60	120
HN2X4LG6	2.17 x 4.10	55.1 x 104.1	.20	5.0	HC2LG6	6	60	120
HN3X3LG6	3.25 x 3.06	82.6 x 77.7	.20	5.0	HC3LG6	6	60	120
HN3X4LG6	3.25 x 4.10	82.6 x 104.1	.20	5.0	HC3LG6	6	60	120
HN4X4LG6	4.25 x 4.10	108.0 x 104.1	.20	5.0	HC4LG6	6	60	60

Part Number shown for LG (Light Gray). Available in WH (White).
Base and cover sold separately.
**"H" dimension includes duct and cover.

UL **PANDUCT® Type H Hinged Cover Wide Slot Wiring Duct**

- Wide slot/finger design provides excellent wire management in general purpose applications and is compatible a wide range of wire sizes and component types
- Material: Lead-free PVC
- Rated for continuous use temperature: 122°F (50°C)
- UL 94 flammability rating of V-0
- Conforms with NFPA 79-2007 section 13.3.1 requirement for flame retardant material
- Provided with standard mounting holes
- Base and cover length is 6 feet

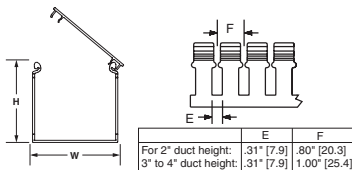

Base Part Number	Duct Size W x H*		Slot Width		Cover Part Number	Std. Pkg. Qty.	Base Ctn. Qty.	Cover Ctn. Qty.
	In.	mm	In.	mm				
H1.5X2LG6	1.75 x 1.98	44.5 x 50.3	.31	7.9	HC1.5LG6	6	120	120
H1.5X3LG6	1.75 x 3.06	44.5 x 77.7	.31	7.9	HC1.5LG6	6	120	120
H2X2LG6	2.17 x 1.98	55.1 x 50.3	.31	7.9	HC2LG6	6	120	120
H2X3LG6	2.17 x 3.06	55.1 x 77.7	.31	7.9	HC2LG6	6	60	120
H2X4LG6	2.17 x 4.10	55.1 x 104.1	.31	7.9	HC2LG6	6	60	120
H3X3LG6	3.25 x 3.06	82.6 x 77.7	.31	7.9	HC3LG6	6	60	120
H3X4LG6	3.25 x 4.10	82.6 x 104.1	.31	7.9	HC3LG6	6	60	120
H4X4LG6	4.25 x 4.10	108.0 x 104.1	.31	7.9	HC4LG6	6	60	60

Part Number shown for LG (Light Gray). Available in BL (Black) and WH (White).
Base and cover sold separately.
**"H" dimension includes duct and cover.

UL **PANDUCT® Type HS Hinged Cover Solid Wall Raceway**

- Solid wall raceway conceals and protects wiring in continuous runs such as in low-voltage cord management applications between control panel stations in conveyor systems
- Material: Lead-free PVC
- UL recognized continuous use temperature: 122°F (50°C)
- UL 94 flammability rating of V-0
- Supplied without mounting holes
- Base and cover length is 6 feet

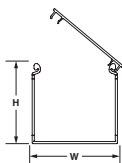

Base Part Number	Duct Size (W x H)*		Cover Part Number	Std. Pkg. Qty.	Base Ctn. Qty.	Cover Ctn. Qty.
	In.	mm				
HS1.5X2LG6NM	1.75 x 1.98	44.5 x 50.3	HC1.5LG6	6	120	120
HS1.5X3LG6NM	1.75 x 3.06	44.5 x 77.7	HC1.5LG6	6	60	120
HS2X2LG6NM	2.17 x 1.98	55.1 x 50.3	HC2LG6	6	120	120
HS2X3LG6NM	2.17 x 3.06	55.1 x 77.7	HC2LG6	6	60	120
HS2X4LG6NM	2.17 x 4.10	55.1 x 104.1	HC2LG6	6	60	120
HS3X3LG6NM	3.25 x 3.06	82.6 x 77.7	HC3LG6	6	60	120
HS3X4LG6NM	3.25 x 4.10	82.6 x 104.1	HC3LG6	6	60	120
HS4X4LG6NM	4.25 x 4.10	108.0 x 104.1	HC4LG6	6	60	60

Part Number shown for LG (Light Gray). For BL (Black) and WH (White) colors see color selection guide, page C1.48.
Base and cover sold separately.
**"H" dimension includes duct and cover.

A. System Overview

B1. Cable Ties

B2. Cable Accessories

B3. Stainless Steel Ties

C1. Wiring Duct

C2. Surface Raceway

C3. Abrasion Protection

C4. Cable Management

D1. Terminals

D2. Power Connectors

D3. Grounding Connectors

E1. Labeling Systems

E2. Labels

E3. Pre-Printed & Write-On Markers

E4. Permanent Identification

E5. Lockout/Tagout & Safety Solutions

F. Index

A. System Overview

Features and Benefits – PANDUCT® Type G Wide Slot Wiring Duct

Available in 36 sizes from .5" x .5" up to 6" x 4" in a variety of colors.

B1. Cable Ties

B2. Cable Accessories

B3. Stainless Steel Ties

C1. Wiring Duct

C2. Surface Raceway

C3. Abrasion Protection

C4. Cable Management

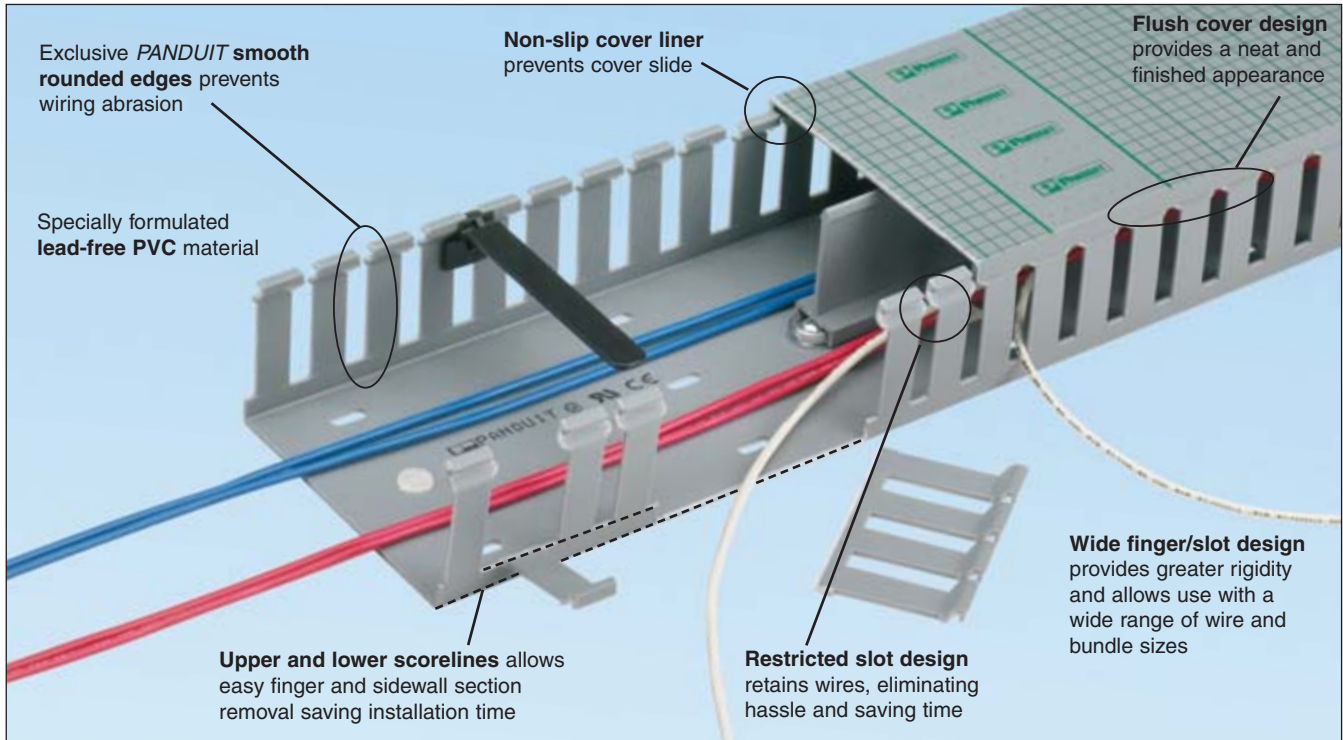

D1. Terminals

D2. Power Connectors

D3. Grounding Connectors



PANDUCT® Wire Retainers
Contain wiring when duct cover is opened. Wire retainers snap easily between duct fingers.
See page C1.28.



PANDUCT® Divider Wall
Create separate wiring channels within the wiring duct base. Available in solid or slotted wall styles.
See page C1.26.

E1. Labeling Systems

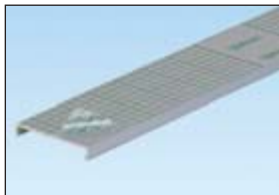

PANDUCT® Type C Cover with Protective Film
Reduces scrap and labor costs by protecting the surface during storage, handling, and installation.
See page C1.9.



PANDUCT® Nylon Rivets
Fast, lowest cost mounting method.
See page C1.34.

E4. Permanent Identification



PANDUCT® Installation Tools
Wide selection of hand tools for cutting and installing wiring duct.
See page C1.34.

E5. Lockout/Tagout & Safety Solutions

F. Index

PANDUCT® Type G Wide Slot Wiring Duct

- Wide slot/finger design provides greater sidewall rigidity and can be used with a wide range of wire bundle sizes
- Material: Lead-free PVC
- UL recognized continuous use temperature: 122°F (50°C)
- UL 94 flammability rating of V-0
- Conforms with NFPA 79-2007 section 13.3.1 requirement for flame retardant material
- Provided with mounting holes
- Base and cover length is 6 feet

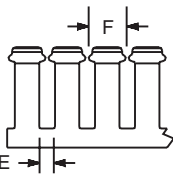
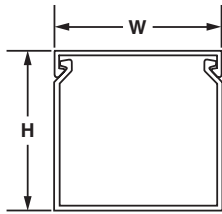
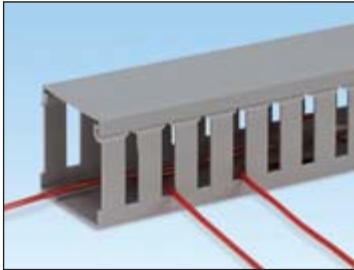

	E	F
For .5" duct height:	.37" [9.4]	.80" [20.3]
.75" to 2" duct height:	.31" [7.9]	.80" [20.3]
3" to 4" duct height:	.31" [7.9]	1.00" [25.4]
5" duct height:	.38" [9.4]	1.33" [33.8]



To order cover with protective film add "-F" to part number. 6" cover not available with film.

Base Part Number	Duct Size (W x H)*		Slot Width		Cover Part Number	Std. Pkg. Qty.	Base Ctn. Qty.	Cover Ctn. Qty.
	In.	mm	In.	mm				
G.5X.5LG6	.69 x .60	17.5 x 15.2	.38	9.7	C.5LG6	6	120	120
G.5X1LG6	.69 x 1.06	17.5 x 26.9	.31	7.9	C.5LG6	6	120	120
G.5X2LG6	.69 x 2.03	17.5 x 51.6	.31	7.9	C.5LG6	6	120	120
G.5X4LG6	.69 x 4.10	17.5 x 104.1	.31	7.9	C.5LG6	6	60	120
G.75X.75LG6	.93 x .82	23.6 x 20.8	.31	7.9	C.75LG6	6	120	120
G.75X1LG6	.93 x 1.06	23.6 x 26.9	.31	7.9	C.75LG6	6	120	120
G.75X1.5LG6	.93 x 1.57	23.6 x 39.9	.31	7.9	C.75LG6	6	120	120
G.75X2LG6	.93 x 2.03	23.6 x 51.7	.31	7.9	C.75LG6	6	120	120
G1X1LG6	1.26 x 1.12	32.0 x 28.4	.31	7.9	C1LG6	6	120	120
G1X1.5LG6	1.26 x 1.62	32.0 x 41.1	.31	7.9	C1LG6	6	120	120
G1X2LG6	1.26 x 2.12	32.0 x 53.8	.31	7.9	C1LG6	6	120	120
G1X3LG6	1.26 x 3.12	32.0 x 79.2	.31	7.9	C1LG6	6	120	120
G1X4LG6	1.26 x 4.10	32.0 x 104.1	.31	7.9	C1LG6	6	60	120
G1.5X1LG6	1.75 x 1.12	44.5 x 28.4	.31	7.9	C1.5LG6	6	120	120
G1.5X1.5LG6	1.75 x 1.62	44.5 x 41.1	.31	7.9	C1.5LG6	6	120	120
G1.5X2LG6	1.75 x 2.12	44.5 x 53.8	.31	7.9	C1.5LG6	6	120	120
G1.5X3LG6	1.75 x 3.12	44.5 x 79.2	.31	7.9	C1.5LG6	6	120	120
G1.5X4LG6	1.75 x 4.10	44.5 x 104.1	.31	7.9	C1.5LG6	6	60	120
G2X1LG6	2.25 x 1.12	57.2 x 28.4	.31	7.9	C2LG6	6	120	120
G2X1.5LG6	2.25 x 1.62	57.2 x 41.1	.31	7.9	C2LG6	6	120	120
G2X2LG6	2.25 x 2.12	57.2 x 53.8	.31	7.9	C2LG6	6	120	120
G2X3LG6	2.25 x 3.12	57.2 x 79.2	.31	7.9	C2LG6	6	60	120
G2X4LG6	2.25 x 4.10	57.2 x 104.1	.31	7.9	C2LG6	6	60	120
G2X5LG6	2.25 x 5.10	57.2 x 129.5	.38	9.7	C2LG6	6	60	120
G2.5X3LG6	2.75 x 3.12	69.9 x 79.2	.31	7.9	C2.5LG6	6	120	120
G3X1LG6	3.25 x 1.12	82.6 x 28.4	.31	7.9	C3LG6	6	120	120
G3X2LG6	3.25 x 2.12	82.6 x 53.8	.31	7.9	C3LG6	6	120	120
G3X3LG6	3.25 x 3.12	82.6 x 79.2	.31	7.9	C3LG6	6	60	120
G3X4LG6	3.25 x 4.10	82.6 x 104.1	.31	7.9	C3LG6	6	60	120
G3X5LG6	3.25 x 5.10	82.6 x 129.5	.38	9.7	C3LG6	6	60	120
G4X1.5LG6	4.25 x 1.62	108.0 x 41.1	.31	7.9	C4LG6	6	120	120
G4X2LG6	4.25 x 2.12	108.0 x 53.8	.31	7.9	C4LG6	6	60	120
G4X3LG6	4.25 x 3.12	108.0 x 79.2	.31	7.9	C4LG6	6	60	120
G4X4LG6	4.25 x 4.10	108.0 x 104.1	.31	7.9	C4LG6	6	60	120
G4X5LG6	4.25 x 5.10	108.0 x 129.5	.38	9.7	C4LG6	6	60	120
G6X4LG6	6.25 x 4.15	158.8 x 105.4	.31	7.9	C6LG6	6	60	120

Part number shown for LG (Light Gray). For other color availability see color selection guide, page C1.48.

Base and cover sold separately.

*"H" dimension includes duct and cover.

A.
System
Overview

B1.
Cable Ties

B2.
Cable
Accessories

B3.
Stainless
Steel Ties

C1.
Wiring
Duct

C2.
Surface
Raceway

C3.
Abrasion
Protection

C4.
Cable
Management

D1.
Terminals

D2.
Power
Connectors

D3.
Grounding
Connectors

E1.
Labeling
Systems

E2.
Labels

E3.
Pre-Printed
& Write-On
Markers

E4.
Permanent
Identification

E5.
Lockout/
Tagout
& Safety
Solutions

F.
Index

A. System Overview

Features and Benefits – PANDUCT® Type F Narrow Slot Wiring Duct

B1. Cable Ties

Available in 30 sizes from .5" x .5" up to 4" x 5" in a variety of colors.

B2. Cable Accessories

B3. Stainless Steel Ties

C1. Wiring Duct

C2. Surface Raceway

C3. Abrasion Protection

C4. Cable Management

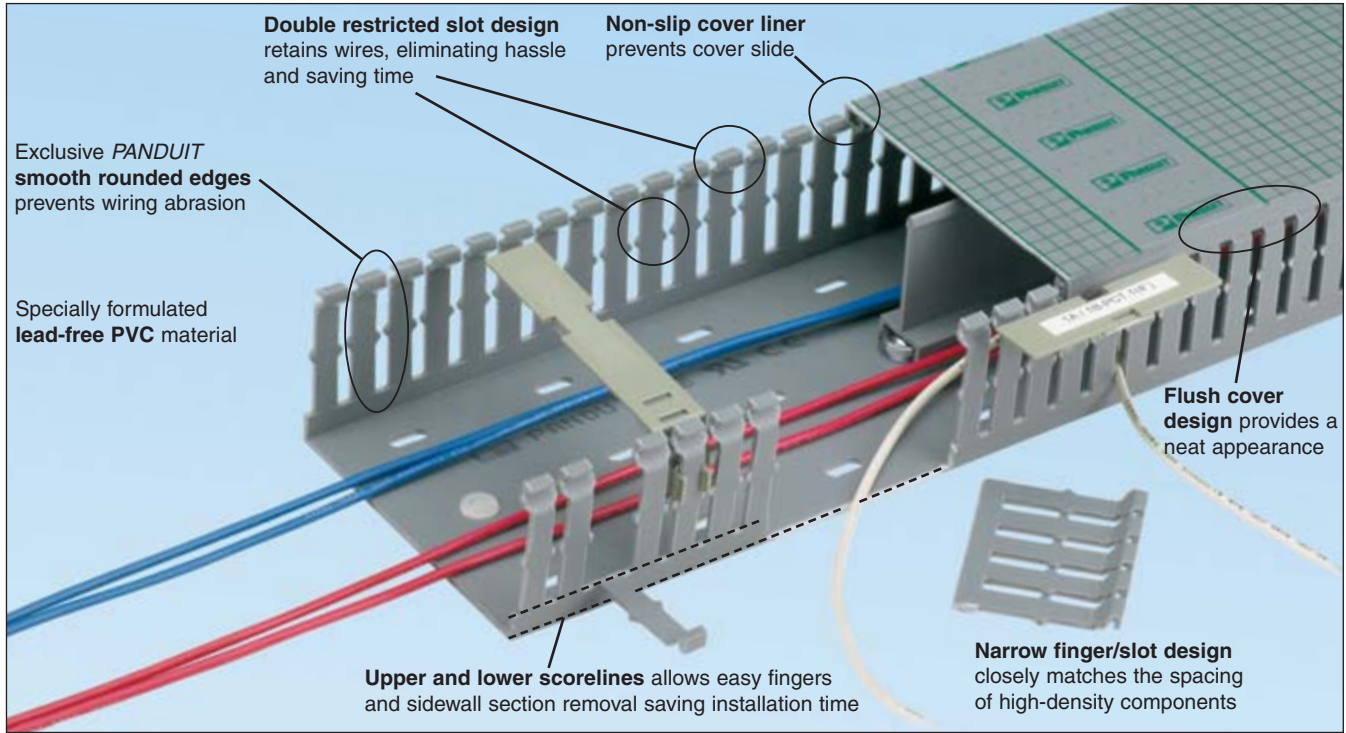

D1. Terminals

D2. Power Connectors

D3. Grounding Connectors

E1. Labeling Systems

E2. Labels

E3. Pre-Printed & Write-On Markers

E4. Permanent Identification

E5. Lockout/Tagout & Safety Solutions

F. Index



PANDUCT® Wire Retainers for Type F Wiring Duct

Contain wiring when duct cover is opened. Wire retainers snap easily between duct fingers. See page C1.28.



PANDUCT® Divider Wall

Create separate wiring channels within the wiring duct base. Available in solid or slotted wall styles. See page C1.26.

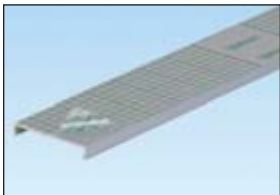

PANDUCT® Type C Cover with Protective Film

Reduces scrap and labor costs by protecting the surface during storage, handling, and installation. See page C1.11.



PANDUCT® Nylon Rivets

Fast, lowest cost mounting method. See page C1.34.



PANDUCT® Installation Tools

Wide selection of hand tools for cutting and installing wiring duct. See page C1.34.

PANDUCT® Type F Narrow Slot Wiring Duct

- Narrow slot/finger design provides more slots to fit the spacing of high-density terminal blocks and other hardware
- Material: Lead-free PVC
- UL recognized continuous use temperature: 122°F (50°C)
- UL 94 flammability rating of V-0
- Conforms with NFPA 79-2007 section 13.3.1 requirement for flame retardant material
- Provided with mounting holes
- Base and cover length is 6 feet

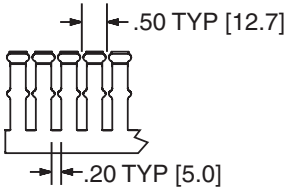
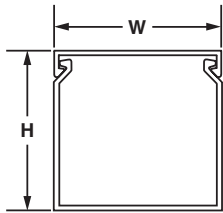
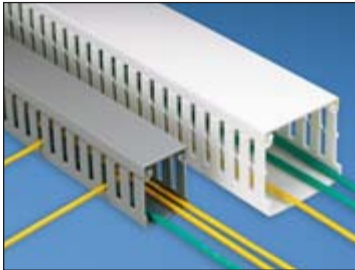

Multiple slot restrictors present with 2" and greater duct wall height.

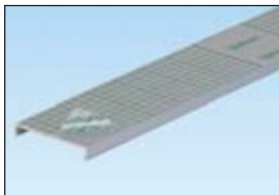

To order cover with protective film add "-F" to part number. 6" cover not available with film.

Base Part Number	Duct Size (W x H)*		Slot Width		Cover Part Number	Std. Pkg. Qty.	Base Ctn. Qty.	Cover Ctn. Qty.
	In.	mm	In.	mm				
F.5X.5LG6	.69 x .60	17.5 x 15.2	.20	5.0	C.5LG6	6	120	120
F.5X1LG6	.69 x 1.06	17.5 x 26.9	.20	5.0	C.5LG6	6	120	120
F.75X.75LG6	.93 x .82	23.6 x 20.9	.20	5.0	C.75LG6	6	120	120
F.75X1.5LG6	.93 x 1.57	23.6 x 39.9	.20	5.0	C.75LG6	6	120	120
F1X1LG6	1.26 x 1.13	32.0 x 28.7	.20	5.0	C1LG6	6	120	120
F1X1.5LG6	1.26 x 1.62	32.0 x 41.1	.20	5.0	C1LG6	6	120	120
F1X2LG6	1.26 x 2.12	32.0 x 53.8	.20	5.0	C1LG6	6	120	120
F1X3LG6	1.26 x 3.12	32.0 x 79.2	.20	5.0	C1LG6	6	120	120
F1X4LG6	1.26 x 4.10	32.0 x 104.1	.20	5.0	C1LG6	6	60	120
F1.5X1LG6	1.75 x 1.12	44.5 x 28.4	.20	5.0	C1.5LG6	6	120	120
F1.5X1.5LG6	1.75 x 1.62	44.5 x 41.1	.20	5.0	C1.5LG6	6	120	120
F1.5X2LG6	1.75 x 2.12	44.5 x 53.8	.20	5.0	C1.5LG6	6	120	120
F1.5X3LG6	1.75 x 3.12	44.5 x 79.2	.20	5.0	C1.5LG6	6	120	120
F1.5X4LG6	1.75 x 4.10	44.5 x 104.1	.20	5.0	C1.5LG6	6	60	120
F2X1LG6	2.25 x 1.12	57.2 x 28.4	.20	5.0	C2LG6	6	120	120
F2X1.5LG6	2.25 x 1.62	57.2 x 41.1	.20	5.0	C2LG6	6	120	120
F2X2LG6	2.25 x 2.12	57.2 x 53.8	.20	5.0	C2LG6	6	120	120
F2X3LG6	2.25 x 3.12	57.2 x 79.2	.20	5.0	C2LG6	6	60	120
F2X4LG6	2.25 x 4.10	57.2 x 104.1	.20	5.0	C2LG6	6	60	120
F2X5LG6	2.25 x 5.10	57.2 x 129.5	.20	5.0	C2LG6	6	60	120
F2.5X3LG6	2.75 x 3.12	69.9 x 79.2	.20	5.0	C2.5LG6	6	120	120
F3X1LG6	3.25 x 1.12	82.6 x 28.4	.20	5.0	C3LG6	6	120	120
F3X2LG6	3.25 x 2.12	82.6 x 53.8	.20	5.0	C3LG6	6	120	120
F3X3LG6	3.25 x 3.12	82.6 x 79.2	.20	5.0	C3LG6	6	60	120
F3X4LG6	3.25 x 4.10	82.6 x 104.1	.20	5.0	C3LG6	6	60	120
F3X5LG6	3.25 x 5.10	82.6 x 129.5	.20	5.0	C3LG6	6	60	120
F4X2LG6	4.25 x 2.12	108.0 x 53.8	.20	5.0	C4LG6	6	60	120
F4X3LG6	4.25 x 3.12	108.0 x 79.2	.20	5.0	C4LG6	6	60	120
F4X4LG6	4.25 x 4.10	108.0 x 104.1	.20	5.0	C4LG6	6	60	120
F4X5LG6	4.25 x 5.10	108.0 x 129.5	.20	5.0	C4LG6	6	60	120

Part number shown for LG (Light Gray). For other color availability see color selection guide, page C1.48. Base and cover sold separately.

*"H" dimension includes duct and cover.

A. System Overview

B1. Cable Ties

B2. Cable Accessories

B3. Stainless Steel Ties

C1. Wiring Duct

C2. Surface Raceway

C3. Abrasion Protection

C4. Cable Management

D1. Terminals

D2. Power Connectors

D3. Grounding Connectors

E1. Labeling Systems

E2. Labels

E3. Pre-Printed & Write-On Markers

E4. Permanent Identification

E5. Lockout/Tagout & Safety Solutions

F. Index

A. System Overview

Features and Benefits – PANDUCT® Flush Cover Type D Round Hole Wiring Duct

Available in sixteen sizes from 1" x 2" up to 4" x 4" in a variety of colors.

B1. Cable Ties

B2. Cable Accessories

B3. Stainless Steel Ties

C1. Wiring Duct

C2. Surface Raceway

C3. Abrasion Protection

C4. Cable Management

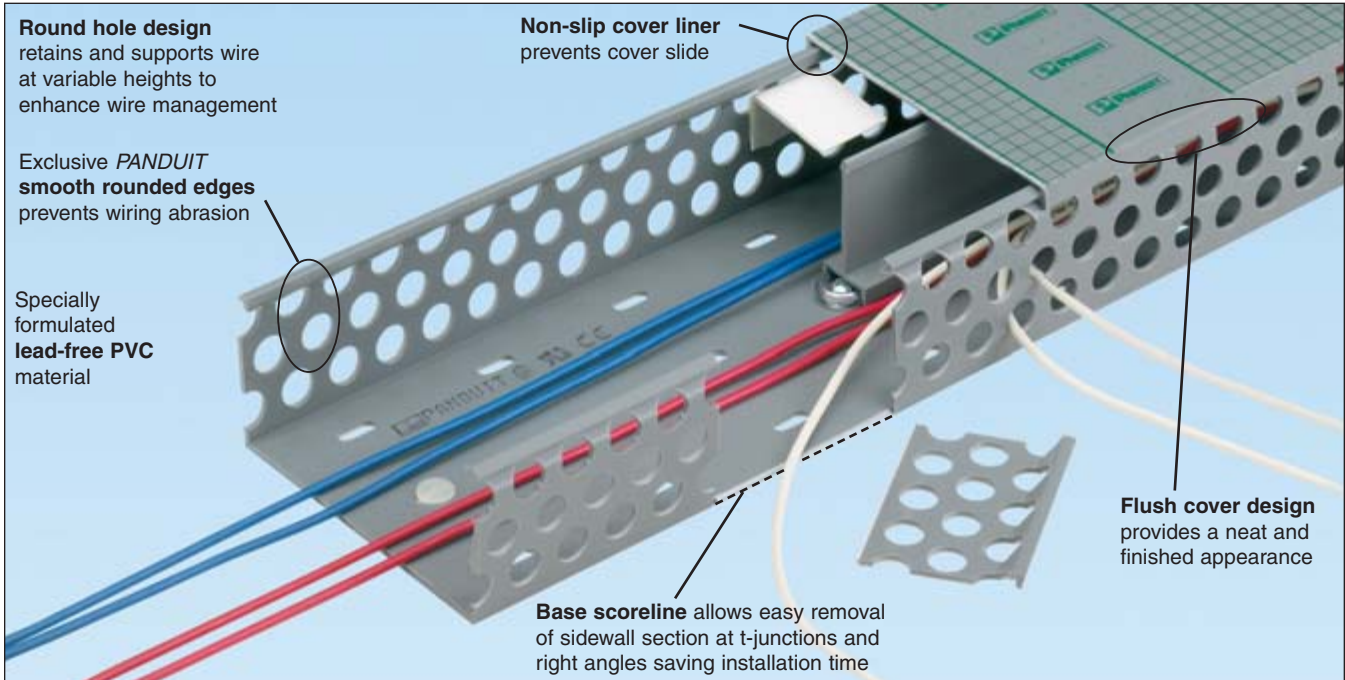

D1. Terminals

D2. Power Connectors

D3. Grounding Connectors

E1. Labeling Systems

E2. Labels

E3. Pre-Printed & Write-On Markers

E4. Permanent Identification

E5. Lockout/Tagout & Safety Solutions

F. Index

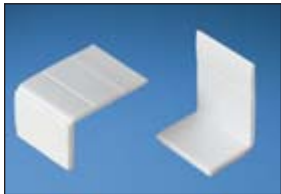

PANDUCT® Wire Retainers for Type D Wiring Duct
Contain wiring when duct cover is opened. Wire retainers mount onto walls with pressure sensitive adhesive. See page C1.28.



PANDUCT® Divider Wall
Create separate wiring channels within the wiring duct base. Available in solid or slotted wall styles. See page C1.26.

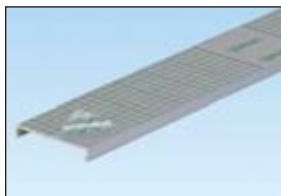

PANDUCT® Type C Cover with Protective Film
Reduces scrap and labor costs by protecting the surface during storage, handling, and installation. See page C1.13.



PANDUCT® Nylon Rivets
Fast, lowest cost mounting method. See page C1.34.



PANDUCT® Installation Tools
Wide selection of hand tools for cutting and installing wiring duct. See page C1.34.

PANDUCT® Flush Cover Type D Round Hole Wiring Duct

- Round hole design has multiple rows of holes to retain and support wire at variable heights and positions
- Material: Lead-free PVC
- UL recognized continuous use temperature: 122°F (50°C)
- UL 94 flammability rating of V-0
- Conforms with NFPA 79-2007 section 13.3.1 requirement for flame retardant material
- Provided with mounting holes
- Base and cover length is 6 feet

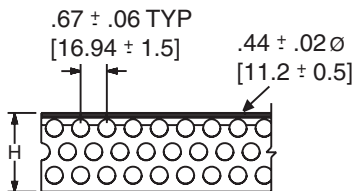
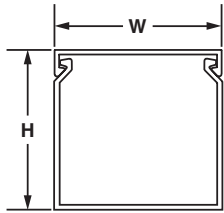
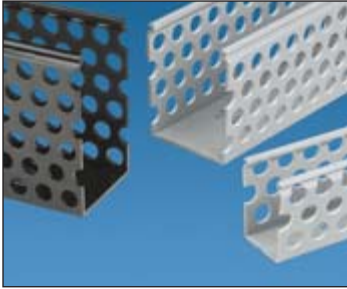

For 2" duct height = 3 rows of holes
 3" duct height = 4 rows of holes
 4" duct height = 6 rows of holes

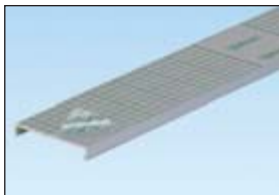

To order cover with protective film add "-F" to part number. 6" cover not available with film.

Base Part Number	Duct Size (W x H)*		Cover Part Number	Std. Pkg. Qty.	Base Ctn. Qty.	Cover Ctn. Qty.
	In.	mm				
D1X2LG6	1.26 x 2.12	32.0 x 53.8	C1LG6	6	120	120
D1X3LG6	1.26 x 3.12	32.0 x 79.2	C1LG6	6	120	120
D1X4LG6	1.26 x 4.10	32.0 x 104.1	C1LG6	6	120	120
D1.5X2LG6	1.75 x 2.12	44.5 x 53.8	C1.5LG6	6	120	120
D1.5X3LG6	1.75 x 3.12	44.5 x 79.2	C1.5LG6	6	120	120
D1.5X4LG6	1.75 x 4.10	44.5 x 104.1	C1.5LG6	6	60	120
D2X2LG6	2.25 x 2.12	57.2 x 53.8	C2LG6	6	120	120
D2X3LG6	2.25 x 3.12	57.2 x 79.2	C2LG6	6	60	120
D2X4LG6	2.25 x 4.10	57.2 x 104.1	C2LG6	6	60	120
D2.5X3LG6	2.75 x 3.12	69.9 x 79.2	C2.5LG6	6	120	120
D3X2LG6	3.25 x 2.12	82.6 x 53.8	C3LG6	6	120	120
D3X3LG6	3.25 x 3.12	82.6 x 79.2	C3LG6	6	60	120
D3X4LG6	3.25 x 4.10	82.6 x 104.1	C3LG6	6	60	120
D4X2LG6	4.25 x 2.12	108.0 x 53.8	C4LG6	6	60	120
D4X3LG6	4.25 x 3.12	108.0 x 79.2	C4LG6	6	60	120
D4X4LG6	4.25 x 4.10	108.0 x 104.1	C4LG6	6	60	120

Part number shown for LG (Light Gray). For other color availability see color selection guide, page C1.48.
 Base and cover sold separately.
 **"H" dimension includes duct and cover.

A. System Overview

B1. Cable Ties

B2. Cable Accessories

B3. Stainless Steel Ties

C1. Wiring Duct

C2. Surface Raceway

C3. Abrasion Protection

C4. Cable Management

D1. Terminals

D2. Power Connectors

D3. Grounding Connectors

E1. Labeling Systems

E2. Labels

E3. Pre-Printed & Write-On Markers

E4. Permanent Identification

E5. Lockout/Tagout & Safety Solutions

F. Index

A.
System
Overview

Features and Benefits – PANDUCT® Type MC Metric Narrow Slot Wiring Duct

B1.
Cable Ties

Available in 22 sizes from 25mm x 25mm up to 100mm x 100mm in international gray and white colors.

B2.
Cable
Accessories

B3.
Stainless
Steel Ties

C1.
Wiring
Duct

C2.
Surface
Raceway

C3.
Abrasion
Protection

C4.
Cable
Management

D1.
Terminals

D2.
Power
Connectors

D3.
Grounding
Connectors

E1.
Labeling
Systems

E2.
Labels

E3.
Pre-Printed
& Write-On
Markers

E4.
Permanent
Identification

E5.
Lockout/
Tagout/
& Safety
Solutions

F.
Index

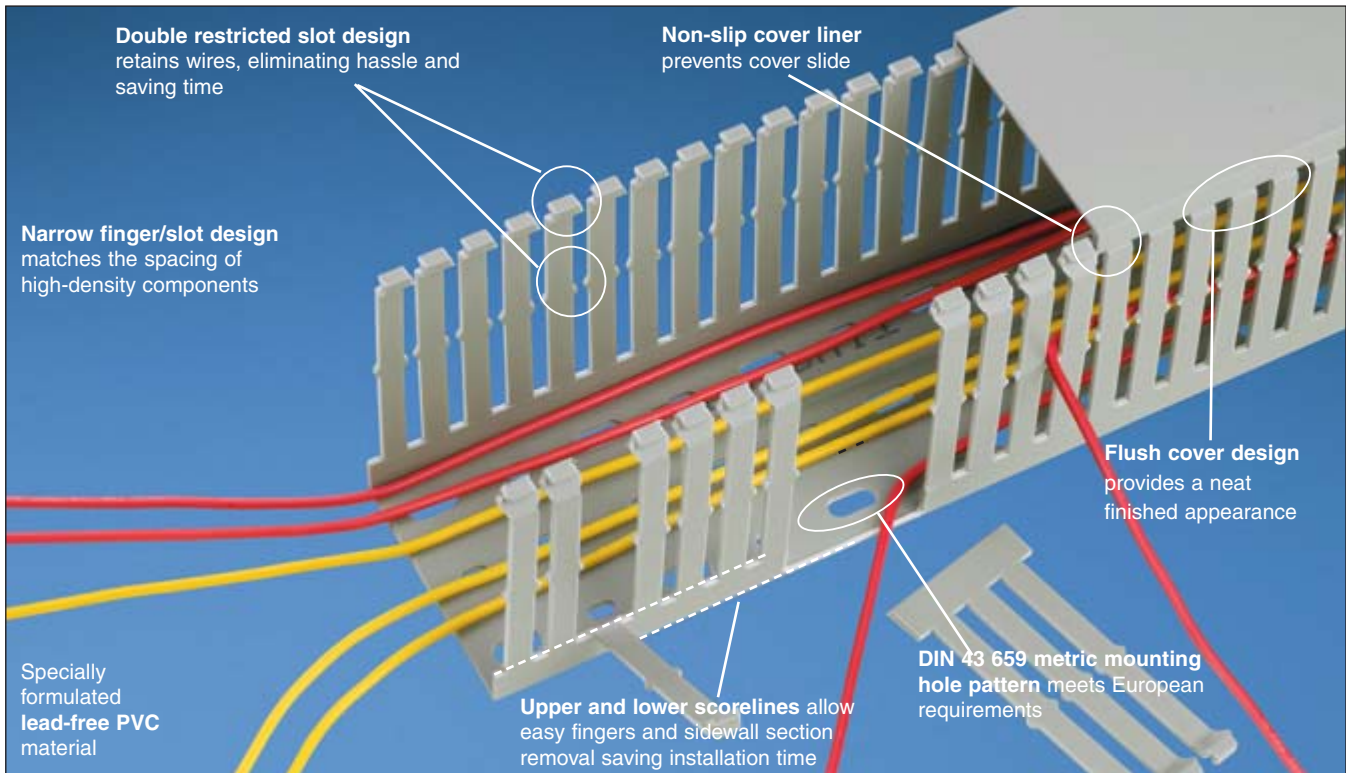

PANDUCT® Wire Retainers for Type MC Wiring Duct
Contain wiring when duct cover is opened. Wire retainers snap easily between duct fingers. See page C1.28.



PANDUCT® Divider Wall
Create separate wiring channels within the wiring duct base. Available in solid or slotted wall styles. See page C1.26.



PANDUCT® Installation Tools
Wide selection of hand tools for cutting and installing wiring duct. See page C1.34.



PANDUCT® Nylon Rivets
Fast, lowest cost mounting method. See page C1.34.

PANDUCT® Type MC Metric Narrow Slot Wiring Duct

- CE compliant and metric sizing for control panels intended for European applications
- Material: Lead-free PVC
- UL recognized continuous use temperature: 122°F (50°C)
- UL 94 flammability rating of V-0
- Conforms with NFPA 79-2007 section 13.3.1 requirement for flame retardant material
- Provided with DIN 43 659 mounting holes
- Duct and cover packaged together in 2m lengths

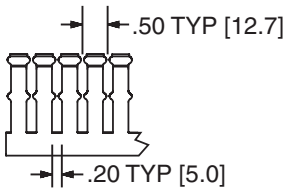
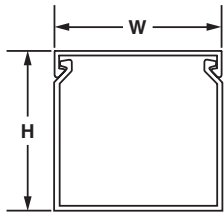
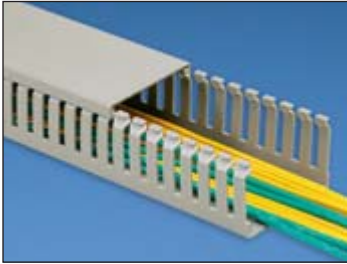

Multiple slot restrictors present with 62mm and greater duct wall height.

Base and Cover Part Number	Duct Size (W x H)*		Slot Width		Replacement Cover Part Number	Base and Cover Pkg. Qty. (m)	Replacement Cover Std. Pkg. Qty.
	mm	In.	In.	mm			
MC25X25IG2	24.6 x 23.6	.97 x .93	.20	5.0	C25IG2	20	20
MC25X37IG2	24.6 x 35.8	.97 x 1.41	.20	5.0	C25IG2	20	20
MC25X50IG2	24.6 x 47.8	.97 x 1.88	.20	5.0	C25IG2	20	20
MC25X62IG2	24.6 x 59.7	.97 x 2.35	.20	5.0	C25IG2	20	20
MC25X75IG2	24.6 x 72.4	.97 x 2.85	.20	5.0	C25IG2	20	20
MC37X37IG2	37.1 x 35.8	1.46 x 1.41	.20	5.0	C37IG2	20	20
MC37X50IG2	37.1 x 47.8	1.46 x 1.88	.20	5.0	C37IG2	20	20
MC37X62IG2	37.1 x 59.7	1.46 x 2.35	.20	5.0	C37IG2	20	20
MC37X75IG2	37.1 x 72.4	1.46 x 2.85	.20	5.0	C37IG2	20	20
MC50X50IG2	49.5 x 47.8	1.95 x 1.89	.20	5.0	C50IG2	20	20
MC50X75IG2	49.5 x 72.4	1.95 x 2.85	.20	5.0	C50IG2	10	20
MC50X100IG2	49.5 x 97.8	1.95 x 3.85	.20	5.0	C50IG2	10	20
MC62X37IG2	62.0 x 35.8	2.44 x 1.41	.20	5.0	C62IG2	20	20
MC62X62IG2	62.0 x 59.7	2.44 x 2.35	.20	5.0	C62IG2	20	20
MC75X50IG2	74.7 x 48.0	2.94 x 1.89	.20	5.0	C75IG2	20	20
MC75X62IG2	74.7 x 59.7	2.94 x 2.35	.20	5.0	C75IG2	20	20
MC75X75IG2	74.7 x 72.4	2.94 x 2.85	.20	5.0	C75IG2	10	20
MC75X100IG2	74.7 x 97.8	2.94 x 3.85	.20	5.0	C75IG2	10	20
MC100X50IG2	99.6 x 48.0	3.92 x 1.89	.20	5.0	C100IG2	10	20
MC100X62IG2	99.6 x 59.7	3.92 x 2.35	.20	5.0	C100IG2	10	20
MC100X75IG2	99.6 x 72.4	3.92 x 2.85	.20	5.0	C100IG2	10	20
MC100X100IG2	99.6 x 97.8	3.92 x 3.85	.20	5.0	C100IG2	10	20

Available in IG (International Gray) and WH (White) colors.

Base and cover sold together.

*"H" dimension includes duct and cover.

A.
System
Overview

B1.
Cable Ties

B2.
Cable
Accessories

B3.
Stainless
Steel Ties

C1.
Wiring
Duct

C2.
Surface
Raceway

C3.
Abrasion
Protection

C4.
Cable
Management

D1.
Terminals

D2.
Power
Connectors

D3.
Grounding
Connectors

E1.
Labeling
Systems

E2.
Labels

E3.
Pre-Printed
& Write-On
Markers

E4.
Permanent
Identification

E5.
Lockout/
Tagout
& Safety
Solutions

F.
Index

A. System Overview

Features and Benefits – *PANDUCT*® Type FS Solid Wall Raceway

Available in 27 sizes from .5" x .5" up to 6" x 4" in a variety of colors.

B1. Cable Ties

B2. Cable Accessories

B3. Stainless Steel Ties

C1. Wiring Duct

C2. Surface Raceway

C3. Abrasion Protection

C4. Cable Management

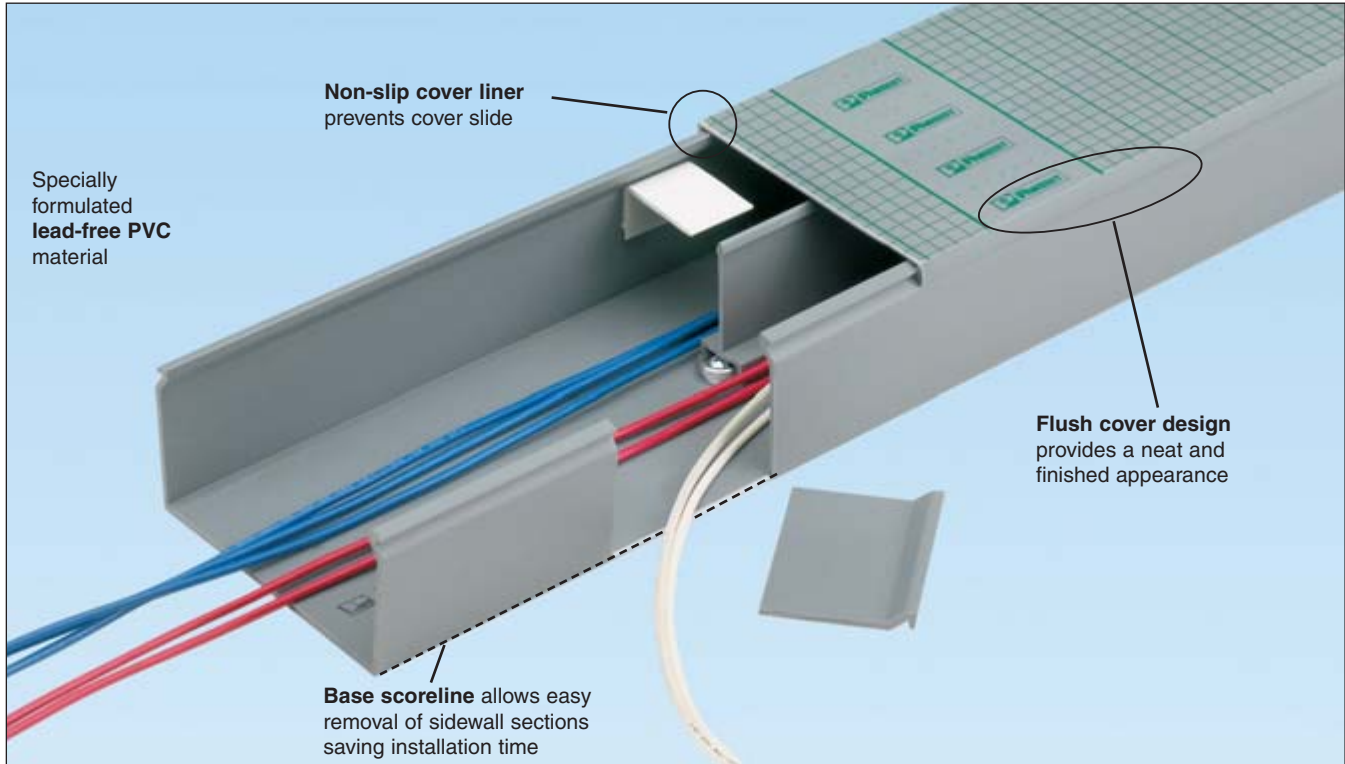

D1. Terminals

D2. Power Connectors

D3. Grounding Connectors

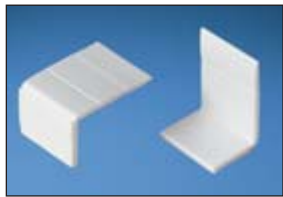

***PANDUCT*® Wire Retainers for Type FS Solid Wall Raceway**
Contain wiring when duct cover is opened. Wire retainers mounts onto walls with pressure sensitive adhesive. See page C1.28.



***PANDUCT*® Divider Wall**
Create separate wiring channels within the wiring duct base. Available in solid or slotted wall styles. See page C1.26.

E1. Labeling Systems

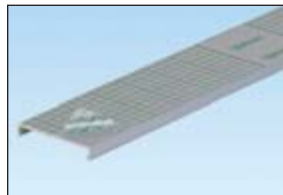

***PANDUCT*® Type C Cover with Protective Film**
Reduces scrap and labor costs by protecting the surface during storage, handling, and installation. See page C1.17.



***PANDUCT*® Nylon Rivets**
Fast, lowest cost mounting method. See page C1.34.

E3. Pre-Printed & Write-On Markers

E4. Permanent Identification



***PANDUCT*® Installation Tools**
Wide selection of hand tools for cutting and installing wiring duct. See page C1.34.

E5. Lockout/Tagout & Safety Solutions

F. Index

PANDUCT® Type FS Solid Wall Raceway

- Solid wall design fully encloses cables providing maximum protection and aesthetics
- Material: Lead-free PVC

- UL recognized continuous use temperature: 122°F (50°C)
- UL 94 flammability rating of V-0
- Base and cover length is 6 feet

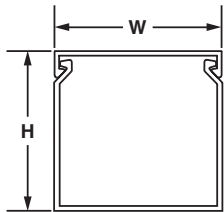

Base Part Number	Duct Size (W x H)*		Cover Part Number	Std. Pkg. Qty.	Base Ctn. Qty.	Cover Ctn. Qty.
	In.	mm				
> FS.5X.5LG6NM	.69 x .60	17.5 x 15.2	C.5LG6	6	120	120
> FS.5X1LG6NM	.69 x 1.06	17.5 x 26.9	C.5LG6	6	120	120
> FS.75X.75LG6NM	.93 x .82	23.6 x 20.8	C.75LG6	6	120	120
> FS1X1LG6NM	1.26 x 1.12	32.0 x 28.4	C1LG6	6	120	120
> FS1X1.5LG6NM	1.26 x 1.62	32.0 x 41.1	C1LG6	6	120	120
> FS1X2LG6NM	1.26 x 2.12	32.0 x 53.8	C1LG6	6	120	120
> FS1X3LG6NM	1.26 x 3.12	32.0 x 79.2	C1LG6	6	120	120
> FS1X4LG6NM	1.26 x 4.10	32.0 x 104.1	C1LG6	6	60	120
> FS1.5X1LG6NM	1.75 x 1.12	44.5 x 28.4	C1.5LG6	6	120	120
> FS1.5X1.5LG6NM	1.75 x 1.62	44.5 x 41.1	C1.5LG6	6	120	120
> FS1.5X2LG6NM	1.75 x 2.12	44.5 x 53.8	C1.5LG6	6	120	120
> FS1.5X3LG6NM	1.75 x 3.12	44.5 x 79.2	C1.5LG6	6	120	120
> FS2X1LG6NM	2.25 x 1.12	57.2 x 28.4	C2LG6	6	120	120
> FS2X1.5LG6NM	2.25 x 1.62	57.2 x 41.1	C2LG6	6	120	120
> FS2X2LG6NM	2.25 x 2.12	57.2 x 53.8	C2LG6	6	120	120
> FS2X3LG6NM	2.25 x 3.12	57.2 x 79.2	C2LG6	6	60	120
> FS2X4LG6NM	2.25 x 4.10	57.2 x 104.1	C2LG6	6	60	120
> FS3X1LG6NM	3.25 x 1.12	82.6 x 28.4	C3LG6	6	120	120
> FS3X2LG6NM	3.25 x 2.12	82.6 x 53.8	C3LG6	6	120	120
> FS3X3LG6NM	3.25 x 3.12	82.6 x 79.2	C3LG6	6	60	120
> FS3X4LG6NM	3.25 x 4.10	82.6 x 104.1	C3LG6	6	60	120
> FS3X5LG6NM	3.25 x 5.10	82.6 x 129.5	C3LG6	6	60	120
> FS4X2LG6NM	4.25 x 2.12	108.0 x 53.8	C4LG6	6	60	120
> FS4X3LG6NM	4.25 x 3.12	108.0 x 79.2	C4LG6	6	60	120
> FS4X4LG6NM	4.25 x 4.10	108.0 x 104.1	C4LG6	6	60	120
> FS4X5LG6NM	4.25 x 5.10	108.0 x 129.5	C4LG6	6	60	120
> FS6X4LG6NM	6.25 x 4.15	158.8 x 105.4	C6LG6	6	60	120

>Indicates parts available with mounting holes. Remove NM from part number.

Part Number shown for LG (Light Gray). For other color availability see Color Selection Guide, page C1.48.

Base and cover sold separately.

*"H" dimension includes duct and cover.

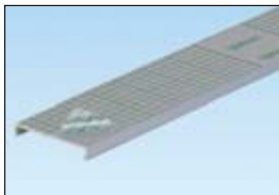

To order cover with protective film add "-F" to part number. 6" cover not available with film.

A.
System
Overview

B1.
Cable Ties

B2.
Cable
Accessories

B3.
Stainless
Steel Ties

C1.
Wiring
Duct

C2.
Surface
Raceway

C3.
Abrasion
Protection

C4.
Cable
Management

D1.
Terminals

D2.
Power
Connectors

D3.
Grounding
Connectors

E1.
Labeling
Systems

E2.
Labels

E3.
Pre-Printed
& Write-On
Markers

E4.
Permanent
Identification

E5.
Lockout/
Tagout/
& Safety
Solutions

F.
Index

A.
System
Overview

Wiring Duct for Special Environments

B1.
Cable Ties

Type NNC Halogen-Free Metric Wiring Duct

B2.
Cable
Accessories

B3.
Stainless
Steel Ties

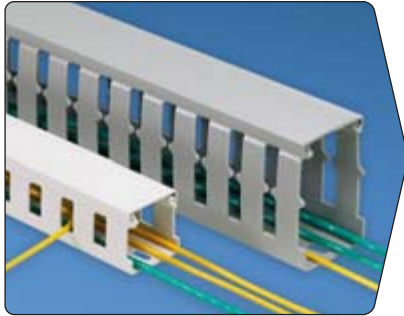

- Halogen-free material is nontoxic, lead-free, environmentally safe and will not release toxic or corrosive gases that could endanger public safety or damage sensitive electronic equipment
- UL 94V-0

C1.
Wiring
Duct

C2.
Surface
Raceway

Type NE NORYL* Halogen-Free Wiring Duct

C3.
Abrasion
Protection

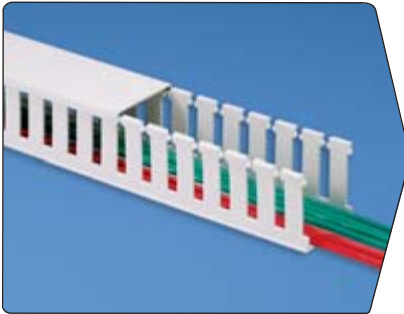

- Halogen-free material is non-toxic, lead-free, environmentally safe and will not release toxic or corrosive gases that could endanger public safety or damage sensitive electronic equipment
- UL 94V-1

C4.
Cable
Management

D1.
Terminals

D2.
Power
Connectors

Type TMC Low Smoke/Low Toxicity Wiring Duct

D3.
Grounding
Connectors

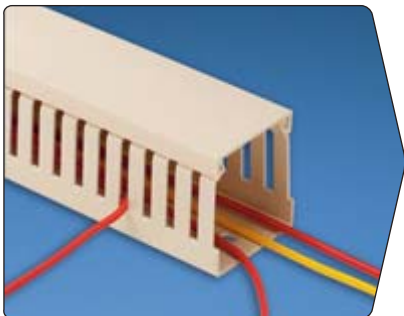

- Low smoke/low toxicity material emits a low level of toxic fumes and low smoke emissions when burned
- Performs to global mass transit rail standards:
 - U.S. Federal Rail Administration Guidelines and NFPA 130 requirements
 - French AFNOR NFF 16 101, 16 102 (I1, F1 classification at 2.1mm thickness)
 - German DIN 5510-2 (S4, SR2, ST2 classification)
 - UNIFER Italian Railway Flammability standard EN UNI11925-2
- UL 94V-0

E1.
Labeling
Systems

E2.
Labels

E3.
Pre-Printed
& Write-On
Markers

E4.
Permanent
Identification

E5.
Lockout/
Tagout/
& Safety
Solutions

F.
Index



The material is self-extinguishing and has excellent flame retardancy UL 94V-0.



The material does not release dense smoke when burned per ASTM E662 test method.



The material does not emit a high volume of toxic gases when burned per Boeing and Airbus test methods.

*NORYL is a registered trademark of General Electric Company.

Environment/Material Specifications **Typical Applications** **pages C1.20 – C1.21**



Semiconductor Manufacturing
Ship Building
Nuclear Power Plants
Oil Platforms

Environment/Material Specifications **Typical Applications** **page C1.24**



Semiconductor Manufacturing
Ship Building
Nuclear Power Plants
Oil Platforms

Environment/Material Specifications **Typical Applications** **pages C1.22 – C1.23**



Passenger Rail Cars; Rail Stations
Other Transportation Vehicles



The material contains no fluorine, bromide, or chlorine and will not emit any corrosive or toxic gases when burned per IEC 60754-2 test method.



Material is rated for a continuous use temperature above 75°C (167°F).

A.
System
Overview

B1.
Cable Ties

B2.
Cable
Accessories

B3.
Stainless
Steel Ties

C1.
Wiring
Duct

C2.
Surface
Raceway

C3.
Abrasion
Protection

C4.
Cable
Management

D1.
Terminals

D2.
Power
Connectors

D3.
Grounding
Connectors

E1.
Labeling
Systems

E2.
Labels

E3.
Pre-Printed
& Write-On
Markers

E4.
Permanent
Identification

E5.
Lockout/
Tagout
& Safety
Solutions

F.
Index

A. System Overview

Features and Benefits – PANDUCT® Type NNC Halogen-Free Metric Wiring Duct

B1. Cable Ties

Available in fourteen sizes from 25mm x 25mm up to 100mm x 100mm in light gray and white.

B2. Cable Accessories

B3. Stainless Steel Ties

C1. Wiring Duct

C2. Surface Raceway

C3. Abrasion Protection

C4. Cable Management

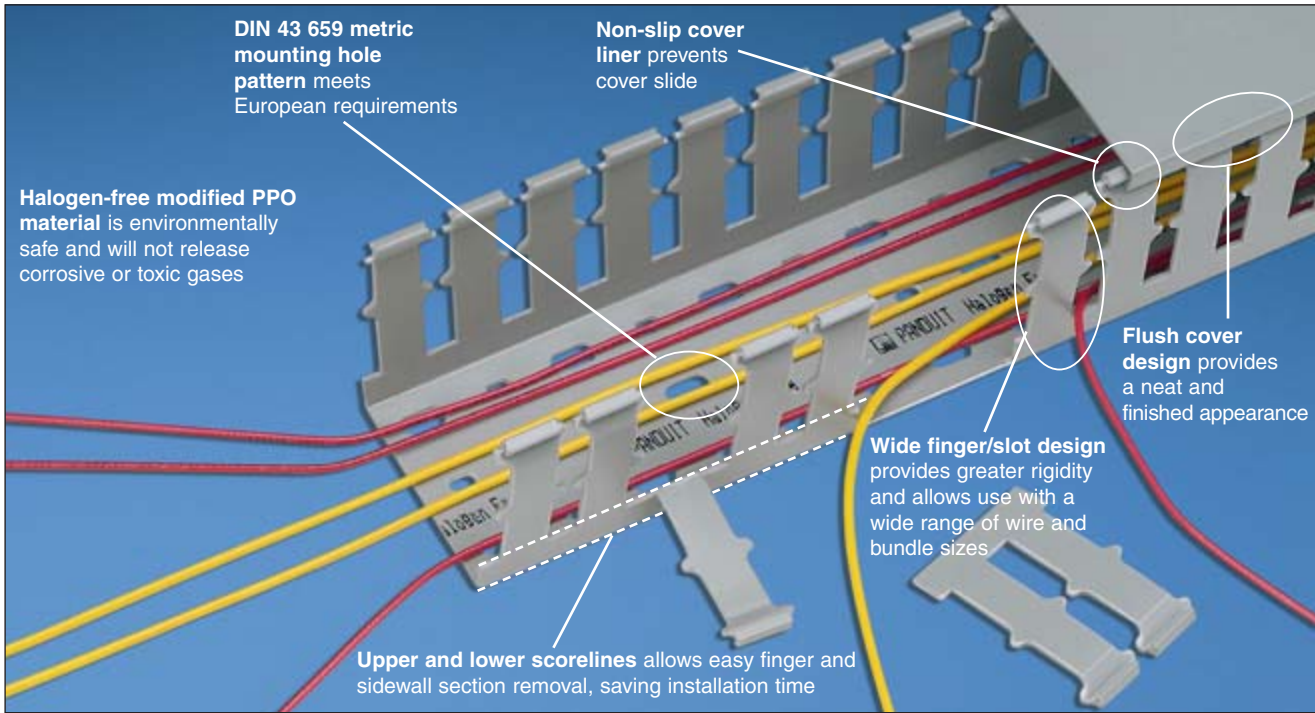

D1. Terminals

D2. Power Connectors

D3. Grounding Connectors

E1. Labeling Systems

E2. Labels

E3. Pre-Printed & Write-On Markers

E4. Permanent Identification

E5. Lockout/Tagout & Safety Solutions

F. Index



PANDUCT® Type NNC Halogen-Free Solid Divider Wall
Create separate wiring channels within the wiring duct base.
See page C1.21.



PANDUCT® Nylon Rivets
Fast, lowest cost mounting method.
See page C1.34.



PANDUCT® Installation Tools
Wide selection of hand tools for cutting and installing wiring duct.
See page C1.34.

PANDUCT® Type NNC Halogen-Free Metric Wiring Duct

- Material: Halogen-free modified PPO material as verified with IEC 60754-2 test method (test on gases evolved during combustion of electric cables)
- UL recognized continuous use temperature: 203°F (95°C)
- UL 94 flammability rating of V-0
- Conforms with NFPA 79-2007 section 13.3.1 requirement for flame retardant material
- Provided with DIN 43 659 mounting holes
- Metric sizing and finger progression
- Duct and cover packaged together in 2m lengths

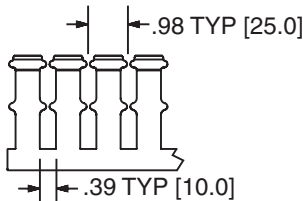
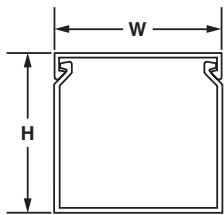
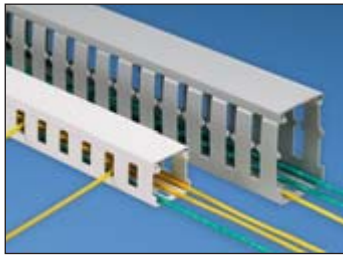

Multiple slot restrictors present with 75mm and greater duct wall height.

Base and Cover Part Number	Duct Size (W x H)*		Slot Width		Replacement Cover Part Number	Base and Cover Ctn. Qty. (m)	Replacement Cover Ctn. Qty. (m)
	mm	In.	In.	mm			
NNC25X25LG2	24.6 x 23.6	.97 x .93	.39	10.0	NC25LG2	20	20
NNC25X37LG2	24.6 x 35.8	.97 x 1.41	.39	10.0	NC25LG2	20	20
NNC25X50LG2	24.6 x 47.8	.97 x 1.88	.39	10.0	NC25LG2	20	20
NNC25X75LG2	24.6 x 72.4	.97 x 2.85	.39	10.0	NC25LG2	20	20
NNC37X37LG2	37.1 x 35.8	1.46 x 1.41	.39	10.0	NC37LG2	20	20
NNC37X50LG2	37.1 x 47.8	1.46 x 1.88	.39	10.0	NC37LG2	20	20
NNC37X75LG2	37.1 x 72.4	1.46 x 2.85	.39	10.0	NC37LG2	20	20
NNC50X50LG2	49.5 x 47.8	1.95 x 1.88	.39	10.0	NC50LG2	20	20
NNC50X75LG2	49.5 x 72.4	1.95 x 2.85	.39	10.0	NC50LG2	10	20
NNC50X100LG2	49.5 x 97.8	1.95 x 3.85	.39	10.0	NC50LG2	10	20
NNC75X75LG2	74.7 x 72.4	2.94 x 2.85	.39	10.0	NC75LG2	10	20
NNC100X50LG2	99.6 x 47.8	3.92 x 1.88	.39	10.0	NC100LG2	10	20
NNC100X75LG2	99.6 x 72.4	3.92 x 2.85	.39	10.0	NC100LG2	10	20
NNC100X100LG2	99.6 x 97.8	3.92 x 3.85	.39	10.0	NC100LG2	10	20

Available in LG (Light Gray) and WH (White).

Do not allow cutting, tapping, or cleaning fluids that contain hydrocarbons to come in contact with type NNC wiring duct as it will cause stress cracking. See page C1.47 for a list of chemicals to avoid.

*"H" dimension includes duct and cover.

PANDUCT® Type NNC Divider Wall

- NNC solid divider wall can be mounted inside NNC and NE wiring duct to create multiple channels
- Material: Halogen-free modified PPO
- Simply install the divider wall base when mounting the duct and snap the divider wall onto mounting base, DB-C



Part Number	Length (m)	For Nominal Duct Height (mm)	Std. Pkg. Qty.	Std. Ctn. Qty. (m)
NNC50DWH2	2	50	2	40
NNC75DWH2	2	75	2	40

Available in WH (White) color only.

Note: Must be used with mounting base, DB-C (see page C1.26) which is sold separately. Install mounting bases to the duct channel, locate within 2" of each divider wall end and at least 12" along the length.

A. System Overview

B1. Cable Ties

B2. Cable Accessories

B3. Stainless Steel Ties

C1. Wiring Duct

C2. Surface Raceway

C3. Abrasion Protection

C4. Cable Management

D1. Terminals

D2. Power Connectors

D3. Grounding Connectors

E1. Labeling Systems

E2. Labels

E3. Pre-Printed & Write-On Markers

E4. Permanent Identification

E5. Lockout/Tagout & Safety Solutions

F. Index

A. System Overview

Features and Benefits – PANDUCT® Type TMC Low Smoke/Low Toxicity Wiring Duct

Available in seven sizes from 25mm x 37mm up to 100mm x 75mm in Beige color.

B1. Cable Ties

B2. Cable Accessories

B3. Stainless Steel Ties

C1. Wiring Duct

C2. Surface Raceway

C3. Abrasion Protection

C4. Cable Management

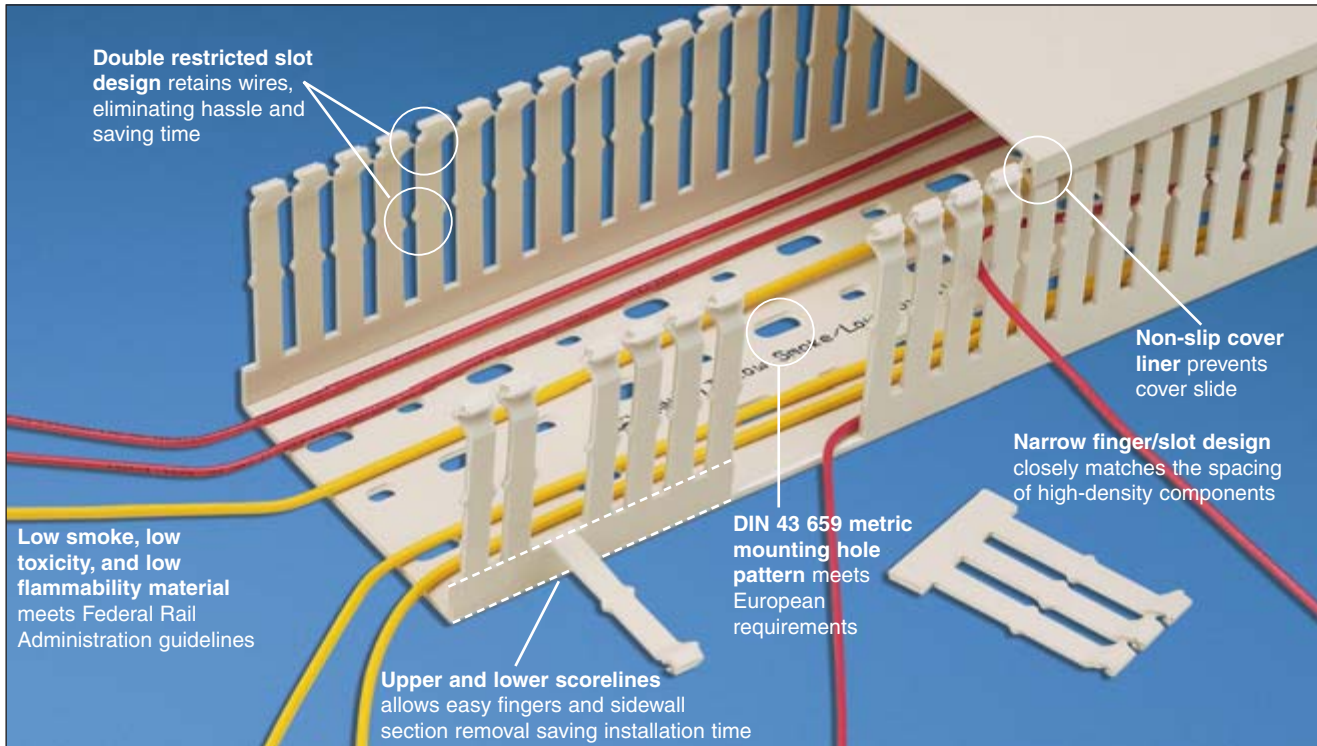

D1. Terminals

D2. Power Connectors

D3. Grounding Connectors



PANDUCT® Wire Retainers for Type TMC Wiring Duct

Contain wiring when duct cover is opened. Wire retainers snap easily between duct fingers. See page C1.28.



PANDUCT® Type TMC Low Smoke/Low Toxicity Solid Divider Wall

Create separate wiring channels within the wiring duct base. See page C1.23.

E1. Labeling Systems



PANDUCT® Installation Tools

Wide selection of hand tools for cutting and installing wiring duct. See page C1.34.



PANDUCT® Nylon Rivets

Fast, lowest cost mounting method. See page C1.34.

E2. Labels

E3. Pre-Printed & Write-On Markers

E4. Permanent Identification

E5. Lockout/Tagout & Safety Solutions

F. Index

PANDUCT® Type TMC Low Smoke/Low Toxicity Wiring Duct

- Material: low smoke, low toxicity, and low flammability thermoplastic
- UL recognized continuous use temperature: 176°F (80°C)
- UL 94 flammability rating of V-0
- Conforms with NFPA 79-2007 section 13.3.1 requirement for flame retardant material
- Provided with DIN 43 659 mounting holes
- Metric sizing and finger progression
- Duct and cover packaged together in 2m lengths

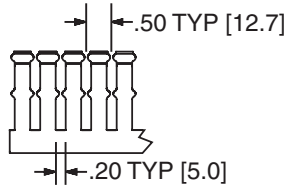
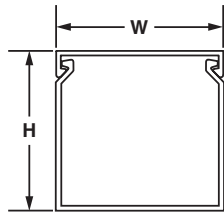
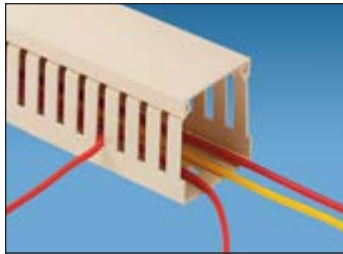

Multiple slot restrictors present with 75mm and greater duct wall height.

Base and Cover Part Number	Duct Size W x H*		Slot Width		Replacement Cover Part Number	Base and Cover Ctn. Qty. (m)	Replacement Cover Ctn. Qty. (m)
	In.	mm	In.	mm			
TMC25X37BR2	.97 x 1.41	24.6 x 35.8	.20	5.0	TC25BR2	20	20
TMC37X37BR2	1.46 x 1.41	37.1 x 35.8	.20	5.0	TC37BR2	20	20
TMC50X50BR2	1.95 x 1.89	49.5 x 48.0	.20	5.0	TC50BR2	20	20
TMC75X50BR2	2.94 x 1.89	74.7 x 48.0	.20	5.0	TC75BR2	20	20
TMC75X75BR2	2.94 x 2.88	74.7 x 73.2	.20	5.0	TC75BR2	10	20
TMC100X50BR2	3.92 x 1.89	99.6 x 48.0	.20	5.0	TC100BR2	10	20
TMC100X75BR2	3.92 x 2.88	99.6 x 73.2	.20	5.0	TC100BR2	10	20

Available in BR (Natural Beige) color only.
*“H” dimension includes duct and cover.

PANDUCT® Type TMC Low Smoke/Low Toxicity Solid Divider Wall

- Wiring duct divider wall can be mounted inside any type of PANDUIT PVC wiring duct to create multiple channels
- Simply install the divider wall base when mounting the duct and snap the divider wall onto the mounting base
- All versions snap onto DB-C mounting base
- Divider wall heights 2 inches and greater have a scoreline feature allowing sections to be removed leaving a smooth edge
- Meets UL 508/508A insulation material requirement for barrier between conductors
- UL 94 flammability rating of V-0
- Material: Lead-free PVC



Part Number	For Nominal Duct Height (mm)	Length (m)	Std. Pkg. Qty.	Std. Ctn. Qty.
TMC50DW2	50	2	2	20
TMC75DW2	75	2	2	20

Note: Must be used with mounting base, DB-C (see page C1.26) which is sold separately. Install mounting bases to the duct channel, locate within 2" of each divider wall end and at least every 12" along the length.

A. System Overview

B1. Cable Ties

B2. Cable Accessories

B3. Stainless Steel Ties

C1. Wiring Duct

C2. Surface Raceway

C3. Abrasion Protection

C4. Cable Management

D1. Terminals

D2. Power Connectors

D3. Grounding Connectors

E1. Labeling Systems

E2. Labels

E3. Pre-Printed & Write-On Markers

E4. Permanent Identification

E5. Lockout/Tagout & Safety Solutions

F. Index

A. System Overview

PANDUCT® Type NE NORYL** Halogen-Free Wiring Duct

B1. Cable Ties

- Material: Halogen-free NORYL**
- UL recognized continuous use temperature: 203°F (95°C)
- UL 94 flammability rating of V-1
- Provided with mounting holes
- Base and cover length is 6 feet

B2. Cable Accessories



B3. Stainless Steel Ties



C1. Wiring Duct

C2. Surface Raceway

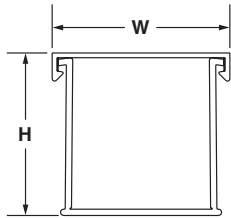

C3. Abrasion Protection

C4. Cable Management

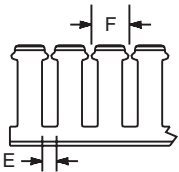

	E	F
For .5" duct height:	.37" [9.4]	.80" [20.3]
1" to 2" duct height:	.31" [7.9]	.80" [20.3]
3" to 4" duct height:	.31" [7.9]	1.00" [25.4]
5" duct height:	.38" [9.4]	1.33" [33.8]

D1. Terminals

D2. Power Connectors

D3. Grounding Connectors

E1. Labeling Systems

E2. Labels

E3. Pre-Printed & Write-On Markers

E4. Permanent Identification

E5. Lockout/Tagout & Safety Solutions

F. Index

Base Part Number	Duct Size W x H*		Slot Width		Cover Part Number	Std. Pkg. Qty.	Base Ctn. Qty.	Cover Ctn. Qty.
	In.	mm	In.	mm				
NE.5X.5WH6	.63 x .56	16.0 x 14.2	.38	9.7	NC.5WH6	6	120	120
NE.5X1WH6	.63 x 1.06	16.0 x 26.9	.31	7.9	NC.5WH6	6	120	120
NE1X1WH6	1.14 x 1.06	29.0 x 26.9	.31	7.9	NC1WH6	6	120	120
NE1X1.5WH6	1.14 x 1.62	29.0 x 41.1	.31	7.9	NC1WH6	6	120	120
NE1X2WH6	1.14 x 2.06	29.0 x 52.3	.31	7.9	NC1WH6	6	120	120
NE1X3WH6	1.14 x 3.06	29.0 x 77.7	.31	7.9	NC1WH6	6	120	120
NE1X4WH6	1.14 x 4.06	29.0 x 103.1	.31	7.9	NC1WH6	6	60	120
NE1.5X1.5WH6	1.64 x 1.62	41.7 x 41.1	.31	7.9	NC1.5WH6	6	120	120
NE1.5X2WH6	1.64 x 2.06	41.7 x 52.3	.31	7.9	NC1.5WH6	6	120	120
NE1.5X3WH6	1.64 x 3.06	41.7 x 77.7	.31	7.9	NC1.5WH6	6	120	120
NE1.5X4WH6	1.64 x 4.06	41.7 x 103.1	.31	7.9	NC1.5WH6	6	60	120
NE2X1WH6	2.14 x 1.06	54.4 x 26.9	.31	7.9	NC2WH6	6	120	120
NE2X2WH6	2.14 x 2.06	54.4 x 52.3	.31	7.9	NC2WH6	6	120	120
NE2X3WH6	2.14 x 3.06	54.4 x 77.7	.31	7.9	NC2WH6	6	60	120
NE2X4WH6	2.14 x 4.06	54.4 x 103.1	.31	7.9	NC2WH6	6	60	120
NE3X1WH6	3.14 x 1.06	79.8 x 26.9	.31	7.9	NC3WH6	6	120	120
NE3X2WH6	3.14 x 2.06	79.8 x 52.3	.31	7.9	NC3WH6	6	120	120
NE3X3WH6	3.14 x 3.06	79.8 x 77.7	.31	7.9	NC3WH6	6	60	120
NE3X4WH6	3.14 x 4.06	79.8 x 103.1	.31	7.9	NC3WH6	6	60	120
NE3X5WH6	3.14 x 5.06	79.8 x 128.5	.38	9.7	NC3WH6	6	60	120
NE4X2WH6	4.14 x 2.06	105.2 x 52.3	.31	7.9	NC4WH6	6	60	120
NE4X3WH6	4.14 x 3.06	105.2 x 77.7	.31	7.9	NC4WH6	6	60	120
NE4X4WH6	4.14 x 4.06	105.2 x 103.1	.31	7.9	NC4WH6	6	60	120
NE4X5WH6	4.14 x 5.06	105.2 x 128.5	.38	9.7	NC4WH6	6	60	120

Available in WH (White) only.

Do not allow cutting, tapping, or cleaning fluids that contain hydrocarbons to come in contact with type NE wiring duct as it will cause stress cracking. See page C1.47 for list of chemicals to avoid.

Base and cover sold separately.

**H" dimension includes duct and cover.

**NORYL is a registered trademark of General Electric Company.

WIRING DUCT TOOLS AND ACCESSORIES

PANDUIT® offers a selection of PANDUCT® Tools and Accessories to aid cutting, modifying, and installing wiring duct.



Some of the features and benefits found in PANDUCT® Tools and Accessories include:

- Wide selection of hand tools for cutting and installing wiring duct
- Snap-in wire retainers to retain cabling when the cover is removed or during cable installation
- Divider walls that mount within the duct enabling multiple channels to be created within a duct channel
- Corner strips hold corners rigid at t-junctions in control panel applications
- Joining strips to connect two sections of duct and hold the walls rigid
- Mounting clips provide an alternative method to mount the duct and allow the duct to be more easily removed

A.
System
Overview

B1.
Cable Ties

B2.
Cable
Accessories

B3.
Stainless
Steel Ties

C1.
Wiring
Duct

C2.
Surface
Raceway

C3.
Abrasion
Protection

C4.
Cable
Management

D1.
Terminals

D2.
Power
Connectors

D3.
Grounding
Connectors

E1.
Labeling
Systems

E2.
Labels

E3.
Pre-Printed
& Write-On
Markers

E4.
Permanent
Identification

E5.
Lockout/
Tagout/
& Safety
Solutions

F.
Index

A. System Overview

PANDUCT® Type FL Flexible Wiring Duct

B1. Cable Ties

- Material: Flexible Polypropylene
- UL 94 flammability rating of V-2
- UL Recognized continuous use temperature: 149°F (65°C)
- Factory applied adhesive tape provided for easy mounting

B2. Cable Accessories



B3. Stainless Steel Ties

Part Number	Duct Size (W x H)*		Length		Std. Pkg. Qty.
	In.	mm	In.	mm	
FL12X12LG-A	.49 x .49	12.5 x 12.5	19.7	500	112
FL25X25LG-A	.98 x .98	25.0 x 25.0	19.7	500	70
FL50X50LG-A	1.97 x 1.97	50.0 x 50.0	19.7	500	32

Available in LG (RAL 7040 Light Gray) color only. Unit of measure is pieces.
**"H" dimension includes duct and cover.

C1. Wiring Duct

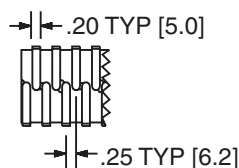
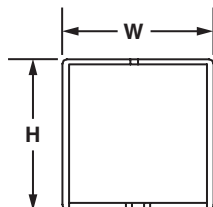

C2. Surface Raceway

PANDUCT® Divider Wall

C3. Abrasion Protection

- Wiring duct divider wall can be mounted inside any type of PANDUIT PVC wiring duct to create multiple channels
- Simply install the divider wall base when mounting the duct and snap the divider wall onto the mounting base
- All versions snap onto DB-C mounting base
- Divider wall heights 2 inches and greater have a scoreline feature allowing sections to be removed leaving a smooth edge
- Meets UL 508/508A insulation material requirement for barrier between conductors
- UL 94 flammability rating of V-0
- Material: Lead-free PVC

C4. Cable Management

D1. Terminals



DB-C

Part Number	Used with Anchors	Std. Pkg. Qty.	Std. Ctn. Qty.
PANDUCT® Divider Wall Mounting Base			
DB-C	PANDUIT NR1 or #8 or #10 screw	100	1000

D2. Power Connectors

D3. Grounding Connectors



D*H6 and D*H2

Part Number	For Nominal Duct Height		Length		Color	Std. Pkg. Qty.	Std. Ctn. Qty.
	In.	mm	Ft.	m			
PANDUCT® Solid Divider Wall							
D1H6	1.00	25	6	—	Light Gray	6	120
D1.5H6	1.50	37	6	—	Light Gray	6	120
D2H6	2.00	50	6	—	Light Gray	6	120
D3H6	3.00	75	6	—	Light Gray	6	120
D4H6	4.00	100	6	—	Light Gray	6	120
D2HWH6	2.00	50	6	—	White	6	120
D3HWH6	3.00	75	6	—	White	6	120
D4HWH6	4.00	100	6	—	White	6	120

E1. Labeling Systems

E2. Labels

E3. Pre-Printed & Write-On Markers

E4. Permanent Identification

E5. Lockout/Tagout & Safety Solutions



SD*H6

Part Number	For Nominal Duct Height	Length	Color	Std. Pkg. Qty.	Std. Ctn. Qty.
	In.	mm	Ft.	m	
PANDUCT® Metric Solid Divider Wall					
D50H2	2.00	50	—	2	International Gray
D75H2	3.00	75	—	2	International Gray
D100H2	4.00	100	—	2	International Gray

Part Number	For Nominal Duct Height	Length	Color	Std. Pkg. Qty.	Std. Ctn. Qty.
	In.	mm	Ft.	m	
PANDUCT® Slotted Divider Wall					
SD2H6	2.00	50	6	—	Light Gray
SD3H6	3.00	75	6	—	Light Gray
SD4H6	4.00	100	6	—	Light Gray
SD2HWH6	2.00	50	6	—	White
SD3HWH6	3.00	75	6	—	White
SD4HWH6	4.00	100	6	—	White

Note: Must be used with mounting base, DB-C (see page C1.26) which is sold separately. Install mounting bases to the duct channel, locate within 2" of each divider wall end and at least every 12" along the length.

PANDUCT® Type NNC Divider Wall

- NNC solid divider wall can be mounted inside NNC and NE wiring duct to create multiple channels
- Material: Halogen-free modified PPO
- Simply install the divider wall base when mounting the duct and snap the divider wall onto mounting base, DB-C



Part Number	For Nominal Duct Height		Std. Pkg. Qty.	Std. Ctn. Qty.
	In.	mm		
NNC50DWH2	2.00	50	2	40
NNC75DWH2	3.00	75	2	40

Available in WH (White) color only.

Note: Must be used with mounting base, DB-C (see page C1.26) which is sold separately. Install mounting bases to the duct channel, locate within 2" of each divider wall end and at least 12" along the length.

PANDUCT® Type TMC Low Smoke/Low Toxicity Solid Divider Wall

- Wiring duct divider wall can be mounted inside any type of PANDUIT PVC wiring duct to create multiple channels
- Simply install the divider wall base when mounting the duct and snap the divider wall onto the mounting base
- All versions snap onto DB-C mounting base
- Divider wall heights 2 inches and greater have a scoreline feature allowing sections to be removed leaving a smooth edge
- Meets UL508/508A insulation material requirement for barrier between conductors
- UL 94 flammability rating of V-0
- Material: Lead-free PVC



Part Number	For Nominal Duct Height		Std. Pkg. Qty.	Std. Ctn. Qty.
	In.	mm		
TMC50DW2	2	50	2	20
TMC75DW2	3	75	2	20

Note: Must be used with mounting base, DB-C (see page C1.26) which is sold separately. Install mounting bases to the duct channel, locate within 2" of each divider wall end and at least every 12" along the length.

A.
System
Overview

B1.
Cable Ties

B2.
Cable
Accessories

B3.
Stainless
Steel Ties

C1.
Wiring
Duct

C2.
Surface
Raceway

C3.
Abrasion
Protection

C4.
Cable
Management

D1.
Terminals

D2.
Power
Connectors

D3.
Grounding
Connectors

E1.
Labeling
Systems

E2.
Labels

E3.
Pre-Printed
& Write-On
Markers

E4.
Permanent
Identification

E5.
Lockout/
Tagout/
& Safety
Solutions

F.
Index

A. System Overview

PANDUCT® Type G and H Wiring Duct Wire Retainers

B1. Cable Ties

- Insert between fingers of type G and H to contain wiring when cover is removed
- Adjustable height
- Material: ABS

B2. Cable Accessories



B3. Stainless Steel Ties

Part Number	For Duct Width In. (mm)	For Duct Height In. (mm)	Std. Pkg. Qty.	Std. Ctn. Qty.
WR2-C	2.00 (50.8)	2.00 – 4.00 (50.8 – 101.6)	100	1000
WR2H-C	2.00(50.5)	2.00 – 4.00 (50.8 – 101.6)	100	1000
WR3-C	3.00 (76.2)	2.00 – 4.00 (50.8 – 101.6)	100	1000
WR4-C	4.00 (101.6)	2.00 – 4.00 (50.8 – 101.6)	100	1000
WR5-C	Use with: 3 x 5, 4 x 5 or 6 x 4		100	1000

*For 2" width type H hinged cover wiring duct use part number WR2H-C.

C1. Wiring Duct

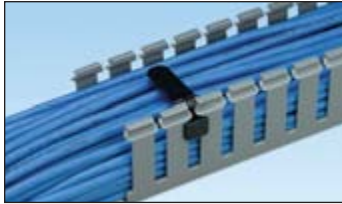

C2. Surface Raceway

C3. Abrasion Protection

PANDUCT® Solid Wall Raceway Type FS and Type D Wiring Duct Wire Retainer

C4. Cable Management

- Mounts onto walls of type FS raceway or type D duct with pressure sensitive adhesive
- Full length is used with 2 inch wide duct; for small widths, break off segments at scorelines
- One size fits three different duct widths
- Material: Lead-free PVC

D1. Terminals

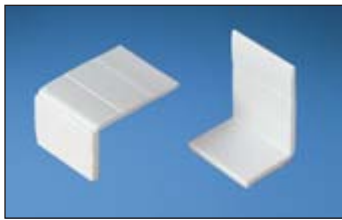

D2. Power Connectors

Part Number	For Duct Width In. (mm)	Std. Pkg. Qty.	Std. Ctn. Qty.
WRS-A-C10	1.00 (25.4) 1.50 (38.1) 2.00 (50.8)	100	1000

Full length is used with 2" wide duct. For smaller widths, break off segments at scorelines.

D3. Grounding Connectors



E1. Labeling Systems

E2. Labels

E3. Pre-Printed & Write-On Markers

E4. Permanent Identification

E5. Lockout/Tagout & Safety Solutions

F. Index

PANDUCT® Type F, HN, MC and TMC Duct Wire Retainers/Labeling Device

- Used to contain wiring when cover is removed and can also be used as a labeling device
- FWR-C works with all type F and HN duct sizes
- FMWR-C works with all type MC and TMC sizes
- Material: Lead-free PVC



Part Number	Material	For Duct Width		Std. Pkg. Qty.	Std. Ctn. Qty.
		In.	mm		
FWR-C	Rigid PVC	1.50 – 4.00	37.0 – 76.2	100	1000
FMWR-C	Rigid PVC	1.46 – 3.94	37 – 100	100	1000



Labeling Inside Duct –
Snaps onto duct fingers. Full length for use with 4" wide duct. For smaller widths, break off segments at scorelines.



Labeling Outside Duct –
Break off the last segment from wire retainer below (1.5" mark) and snap onto the back of the remaining segment. Install label and mount between fingers facing outward.

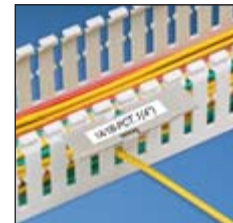

PANDUCT® Duct Corner Strips with 1 Inch Bend Radius Control

- Create a strong rigid corner at wiring duct junctions
- Provide bend radius protection for cabling as required in NFPA 79-2007 section 13.1.5.9 and TIA/EIA-568-B and 569-A
- Available in five pre-cut sizes and 6-foot lengths that can be cut-to-size to meet any size requirement
- Easy to install two-piece design
- Compatible with all styles of PANDUIT wiring duct
- UL 94 flammability rating of V-0
- Material: Lead-free PVC



Part Number	Part Description	For Duct Height		Color	Std. Pkg. Qty.	Std. Ctn. Qty.
		In.	mm			

6' Lengths for use with all Types of PVC Wiring Duct

CSC1LG6	Cut-to-size 6' corner strip with a 1" bend radius.	All sizes (Cut to duct height)	All sizes (Cut to duct height)	Light Gray	6	120
CSC1WH6				White	6	120

Pre-Cut Pieces for use with all Types of PVC Wiring Duct

CSPC1LG-Q	1" bend radius corner strip pre-cut for 1" wall height.	1.00	25.4	Light Gray	25	250
CSPC1.5LG-Q	1" bend radius corner strip pre-cut for 1.5" wall height (2.0" type H duct).	1.50	38.1	Light Gray	25	250
CSPC2LG-Q	1" bend radius corner strip pre-cut for 2" wall height.	2.00	50.8	Light Gray	25	250
CSPC3LG-Q	1" bend radius corner strip pre-cut for 3" wall height.	3.00	76.2	Light Gray	25	250
CSPC4LG-Q	1" bend radius corner strip pre-cut for 4" wall height (4.0" type H duct).	4.00	101.6	Light Gray	25	250

CSPC available in Light Gray color only.

Order number of feet required, in multiples of 6' or Standard Package Quantity for pieces offered in 6' lengths.

A.
System
Overview

B1.
Cable Ties

B2.
Cable
Accessories

B3.
Stainless
Steel Ties

C1.
Wiring
Duct

C2.
Surface
Raceway

C3.
Abrasion
Protection

C4.
Cable
Management

D1.
Terminals

D2.
Power
Connectors

D3.
Grounding
Connectors

E1.
Labeling
Systems

E2.
Labels

E3.
Pre-Printed
& Write-On
Markers

E4.
Permanent
Identification

E5.
Lockout/
Tagout/
& Safety
Solutions

F.
Index

A. System Overview

PANDUCT® Duct Corner Strips

B1. Cable Ties

- Slide onto duct at corner or t-junctions for smooth, round corners
- Available in five pre-cut sizes and 6-foot lengths that can be cut to meet any size requirement
- Easy to install one-piece design
- Compatible with all styles of *PANDUIT* wiring duct
- UL 94 flammability rating of V-0
- Material: Lead-free PVC

B2. Cable Accessories



CS1LG6

B3. Stainless Steel Ties

C1. Wiring Duct

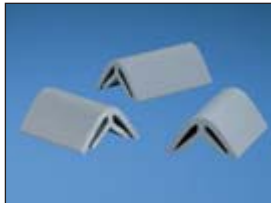

CSP*LG-Q

C2. Surface Raceway

C3. Abrasion Protection

C4. Cable Management

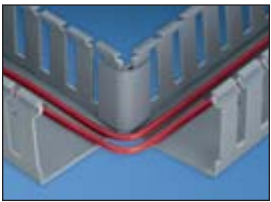

Part Number	Part Description	For Nominal Duct Height		Color	Std. Pkg. Qty.	Std. Ctn. Qty.
		In.	mm			
6' Lengths for use with all Types of PVC Wiring Duct						
CS1LG6	6' length is cut by user to fit duct height.	Cut-to-size	Cut-to-size	Light Gray	6	120
CS1WH6	6' length is cut by user to fit duct height.	Cut-to-size	Cut-to-size	White	6	120

Pre-Cut Pieces for use with all Types of PVC Wiring Duct*

Part Number	Pre-cut pieces.	In.	mm	Light Gray	Std. Pkg. Qty.	Std. Ctn. Qty.
CSP1LG-Q		1.00	25.4		25	250
CSP1.5LG-Q		1.50	38.1		25	250
CSP2LG-Q		2.00	50.8		25	250
CSP3LG-Q		3.00	76.2		25	250
CSP4LG-Q		4.00	101.6		25	250

*Available in LG (Light Gray) only.

D1. Terminals

PANDUCT® Duct Joining Strips

D2. Power Connectors

- Slide onto duct to join sections together
- Available in 6-foot lengths that can be cut to meet any size requirement
- Easy to install one-piece design
- Compatible with all styles of *PANDUIT* wiring duct
- UL 94 flammability rating of V-0
- Material: Lead-free PVC

D3. Grounding Connectors



DJS1**6

E1. Labeling Systems

E2. Labels

E3. Pre-Printed & Write-On Markers

E4. Permanent Identification

E5. Lockout/Tagout & Safety Solutions

F. Index

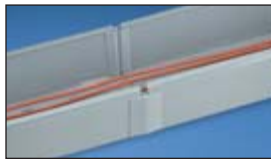

Part Number	Part Description	For Duct Height		Color	Std. Pkg. Qty.	Std. Ctn. Qty.
		In.	mm			
6' Lengths for use with all Types of PVC Wiring Duct						
DJS1LG6	6' length is cut by user to fit duct height.	Cut-to-size	Cut-to-size	Light Gray	6	120
DJS1WH6				White		

To cut product to proper length subtract 1/2" from the duct wall height (example: for G2X2LG6, cut DJS1**6 to 1 1/2" length).

PANDUCT® Snap-Clip Mounting Brackets

- Duct easily snaps into bracket
- No mounting holes required in duct
- Ensures no metal is inside the duct
- Snap-clip spacing is not critical
- Simplifies fabrication drawings and panel layout
- Material: Spring steel



Part Number	Screw Required	For Duct Width		Std. Pkg. Qty.	Std. Ctn. Qty.
		In.	mm		
Snap-Clip Mounting Brackets for use with Types G, F, FS and D Wiring Duct					
S1F-C	#8-32 x 1/4 (Provided)	1.00	25.4	100	1000
S1.5F-C	#8-32 x 1/4 (Provided)	1.50	38.1	100	1000
S2F-C	#8-32 x 1/4 (Provided)	2.00	50.8	100	1000
S3F-C	#8-32 x 1/4 (Provided)	3.00	76.2	100	1000
S4F-C	#8-32 x 1/4 (Provided)	4.00	101.6	100	1000
Snap-Clip Mounting Brackets for use with Types MC, NNC, and TMC Wiring Duct					
SNS25F-C	#8-32 x 1/4 (User Supplied)	1.00	25	100	1000
SNS37F-C	#8-32 x 1/4 (User Supplied)	1.50	37	100	1000
SNS50F-C	#8-32 x 1/4 (User Supplied)	2.00	50	100	1000
SNS62F-C	#8-32 x 1/4 (User Supplied)	2.50	62	100	1000
SNS75F-C	#8-32 x 1/4 (User Supplied)	3.00	75	100	1000

PANDUCT® Snap-Clip Mounting Bracket – Type NE Wiring Duct

- Duct easily snaps into bracket
- Ensures no metal is inside the duct
- Snap-clip spacing is not critical
- Simplifies fabrication drawings and panel layout
- Material: Spring steel



Part Number	Screw Required	For Duct Width		Std. Pkg. Qty.	Std. Ctn. Qty.
		In.	mm		
SNS.5-C	#6-32 x 1/4 (User Supplied)	.50	12.7	100	1000
SNS.75-C	#6-32 x 1/4 (User Supplied)	.75	19.1	100	1000
SNS1-C	#8-32 x 1/4 (User Supplied)	1.00	25.4	100	1000
SNS1.5-C	#8-32 x 1/4 (User Supplied)	1.50	38.1	100	1000
SNS2-C	#8-32 x 1/4 (User Supplied)	2.00	50.8	100	1000
SNS3-C	#8-32 x 1/4 (User Supplied)	3.00	76.2	100	1000

A.
System
Overview

B1.
Cable Ties

B2.
Cable
Accessories

B3.
Stainless
Steel Ties

C1.
Wiring
Duct

C2.
Surface
Raceway

C3.
Abrasion
Protection

C4.
Cable
Management

D1.
Terminals

D2.
Power
Connectors

D3.
Grounding
Connectors

E1.
Labeling
Systems

E2.
Labels

E3.
Pre-Printed
& Write-On
Markers

E4.
Permanent
Identification

E5.
Lockout/
Tagout/
& Safety
Solutions

F.
Index

A.
System
Overview

Adhesive Tape for Wiring Duct

- Recommended installation temperature is 70°F (21°C)
- Optimum recommended dwell time for acrylic adhesive is 8 hours
- UL Recognized service temperature is 32°F (0°C) to 140°F (60°C)
- Recommended tape load is 1/2 lb. per square inch of tape area

B1.
Cable Ties

B2.
Cable
Accessories



B3.
Stainless
Steel Ties

C1.
Wiring
Duct

C2.
Surface
Raceway

C3.
Abrasion
Protection

C4.
Cable
Management

D1.
Terminals

D2.
Power
Connectors

D3.
Grounding
Connectors

E1.
Labeling
Systems

E2.
Labels

E3.
Pre-Printed
& Write-On
Markers

E4.
Permanent
Identification

E5.
Lockout/
Tagout/
& Safety
Solutions

F.
Index

Duct Size W x H	Tape Part Number	Roll Length		Std. Pkg. Qty.	Std. Ctn. Qty.
		Yds.	m		
.5 x .5 thru 1.5 x 4	P32W2A2-50-7	7.0	6.4	1	100
	P32W2A2-50-72	72.0	65.5	1	9
2 x 1 thru 3 x 3	P32W2A2-50-7	7.0	6.4	1	100
	P32W2A2-50-72	72.0	65.5	1	9
3 x 4 thru 3 x 5	P32W2A2-75-7	7.0	6.4	1	60
	P32W2A2-75-72	72.0	65.5	1	7
4 x 1.5 thru 4 x 3	P32W2A2-50-7	7.0	6.4	1	100
	P32W2A2-75-72	72.0	65.5	1	9
4 x 4 thru 6 x 4	P32W2A2-75-7	7.0	6.4	1	60
	P32W2A2-75-72	72.0	65.5	1	7

Specifications for Factory Applied Tape

Duct Size (W x H)	Rows of Tape	Tape			
		Width		Thickness	
		In.	mm	In.	mm
.5x.5 through .75x2	1	.50	12.7	.03	.8
1x1 through 1.5x4	1	.75	19.1	.03	.8
2x1 through 3x3	2	.50	12.7	.03	.8
3x4 through 3x5	2	.75	19.1	.03	.8
4x1.5 through 4x3	2	.50	12.7	.03	.8
4x4 through 6x4	2	.75	19.1	.03	.8

Adhesive Tape Guide

Selection of wiring duct part numbers available with factory applied adhesive tape.



G Duct Light Gray	G Duct White	G Duct Black	F Duct Light Gray	NE Duct White
G.5X.5LG6-A	G.5X.5WH6-A	—	F.5X.5LG6-A	—
G.5X1LG6-A	G.5X1WH6-A	—	F.5X1LG6-A	—
G.75X.75LG6-A	—	—	F.75X.75LG6-A	—
G.75X1LG6-A	G.75X1WH6-A	—	—	—
G.75X1.5LG6-A	G.75X1.5WH6-A	—	F.75X1.5LG6-A	—
G.75X2LG6-A	G.75X2WH6-A	—	—	—
G1X1LG6-A	G1X1WH6-A	—	F1X1LG6-A	—
G1X1.5LG6-A	G1X1.5WH6-A	—	F1X1.5LG6-A	—
G1X2LG6-A	G1X2WH6-A	—	F1X2LG6-A	NE1X2WH6-A
G1X3LG6-A	G1X3WH6-A	G1X3BL6-A	F1X3LG6-A	—
G1X4LG6-A	G1X4WH6-A	—	F1X4LG6-A	—
G1.5X1LG6-A	G1.5X1WH6-A	—	F1.5X1LG6-A	—
G1.5X1.5LG6-A	G1.5X1.5WH-A	—	F1.5X1.5LG6-A	—
G1.5X2LG6-A	G1.5X2WH6-A	—	F1.5X2LG6-A	NE1.5X2WH6-A
G1.5X3LG6-A	G1.5X3WH6-A	—	F1.5X3LG6-A	—
G1.5X4LG6-A	G1.5X4WH6-A	—	F1.5X4LG6-A	—
G2X1LG6-A	G2X1WH6-A	—	F2X1LG6-A	—
G2X1.5LG6-A	G2X1.5WH6-A	—	F2X1.5LG6-A	—
G2X2LG6-A	G2X2WH6-A	G2X2BL6-A	F2X2LG6-A	NE2X2WH6-A
G2X3LG6-A	G2X3WH6-A	—	F2X3LG6-A	—
G2X4LG6-A	G2X4WH6-A	G2X4BL6-A	F2X4LG6-A	—
G2X5LG6-A	G2X5WH6-A	—	F2X5LG6-A	—
G2.5X3LG6-A	G2.5X3WH6-A	—	—	—
G3X1LG6-A	G3X1WH6-A	—	F3X1LG6-A	—
G3X2LG6-A	G3X2WH6-A	—	F3X2LG6-A	—
G3X3LG6-A	G3X3WH6-A	G3X3BL6-A	F3X3LG6-A	—
G3X4LG6-A	G3X4WH6-A	—	F3X4LG6-A	—
G3X5LG6-A	G3X5WH6-A	—	F3X5LG6-A	—
G4X1.5LG6-A	G4X1.5WH6-A	—	—	—
G4X2LG6-A	G4X2WH6-A	—	F4X2LG6-A	NE4X2WH6-A
G4X3LG6-A	G4X3WH6-A	—	F4X3LG6-A	NE4X3WH6-A
G4X4LG6-A	G4X4WH6-A	G4X4BL6-A	F4X4LG6-A	NE4X4WH6-A
G4X5LG6-A	G4X5WH6-A	—	F4X5LG6-A	—

All three sizes of flexible duct come provided with adhesive: FL12X12LG-A, FL25X25LG-A, FL50X50LG-A.

A.
System
Overview

B1.
Cable Ties

B2.
Cable
Accessories

B3.
Stainless
Steel Ties

C1.
Wiring
Duct

C2.
Surface
Raceway

C3.
Abrasion
Protection

C4.
Cable
Management

D1.
Terminals

D2.
Power
Connectors

D3.
Grounding
Connectors

E1.
Labeling
Systems

E2.
Labels

E3.
Pre-Printed
& Write-On
Markers

E4.
Permanent
Identification

E5.
Lockout/
Tagout/
& Safety
Solutions

F.
Index

A. System Overview

PANDUCT® Installation Tools

B1. Cable Ties

- PBDCT and DCT easily cut *PANDUCT*® Wiring Duct and Cover
- DNT-100 notches duct sidewalls to bottom scoreline for tees and corner junctions
- TNR installs or removes *PANDUIT* Nylon Rivets, NR1-C and NR1-M, quickly and easily
- DFCT easily removes duct fingers in tight places

B2. Cable Accessories



PBDCT



Part Number	Part Description	Std. Pkg. Qty
Duct Cutting Tool		
PBDCT	<i>PANDUIT</i> bench-mount duct cutting tool. Cuts slotted wiring ducts and wiring duct covers with up to 6" width and up to 5" height. Full 78.74" (2m) measuring scale. Includes safety guarding.	1
DCT	Hand-held duct cutting tool.	1

B3. Stainless Steel Ties

C1. Wiring Duct



DCT



DFCT

Replacement Blade Kit (Includes blade and nylon insert)

DCT-BLD	Replacement blade kit with blade and nylon insert.	1
---------	--	---

C2. Surface Raceway

Replacement Nylon Insert

DCT-RI	Replacement nylon insert.	5
--------	---------------------------	---

C3. Abrasion Protection



DNT-100



TNR

Duct Finger Cutting Tool (For use with all wide slotted duct types)

DFCT	Hand-held duct finger cutting tool.	1
------	-------------------------------------	---

C4. Cable Management

Duct Notching Tool (For use with all slotted duct types)

DNT-100	Hand-held sidewall notching tool.	1
---------	-----------------------------------	---

D1. Terminals



NR1

Nylon Rivet Installation Tool

TNR	Hand-held nylon rivet installation tool.	1
-----	--	---

D2. Power Connectors

Nylon Rivets

NR1-C	Nylon rivet for use with TNR rivet tool. Mean pull-off force: PVC 90 lbs., Noryl Duct (Type NE) 70 lbs. Mean shear force: PVC 139 lbs., Noryl Duct (Type NE) 126 lbs.	100
NR1-M	Nylon rivet for use with TNR rivet tool. Mean pull-off force: PVC 90 lbs., Noryl Duct (Type NE) 70 lbs. Mean shear force: PVC 139 lbs., Noryl Duct (Type NE) 126 lbs.	1000

Always use approved safety goggles when using any tools.

D3. Grounding Connectors

Total Thickness of Panel and Duct		Panel Hole Dia. Needed		ANSI Standard Drill Bit
In.	mm	In.	mm	
.158 – .187	4.0 – 4.7	.187	4.7	#15
.188 – .218	4.8 – 5.5	.193	4.9	#11
.219 – .250	5.6 – 6.4	.203	5.2	#7
.251 – .281	6.5 – 7.1	.213	5.4	#4

E1. Labeling Systems

E2. Labels

E3. Pre-Printed & Write-On Markers

E4. Permanent Identification

E5. Lockout/Tagout & Safety Solutions

F. Index

PANDUCT® PANELMAX™ Corner Wiring Duct Dimensions

Dimensions are shown for reference only. Contact PANDUIT customer service at 800-777-3300 for specific dimensional needs.

Size	Dimensions – Inches (mm)								
	A	C	D	G	H	K	T	W	Z
CWD3	4.98 (126.6)	2.25 (57.2)	2.83 (71.8)	3.10 (79.1)	3.57 (90.7)	3.95 (100.4)	.10 (2.4)	4.40 (111.8)	5.16 (131.0)
CWD4	5.94 (150.9)	2.25 (57.2)	3.84 (97.5)	4.10 (104.1)	4.58 (115.7)	4.89 (124.3)	.11 (2.7)	5.33 (135.3)	6.54 (166.0)

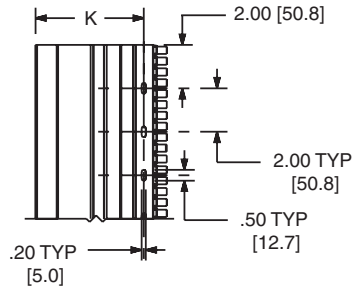
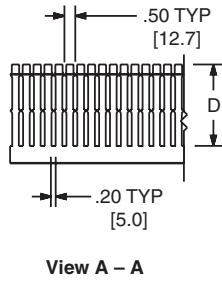
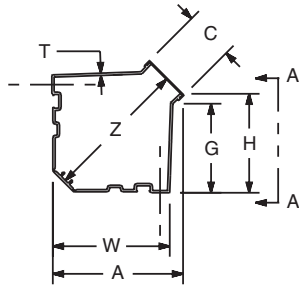

A.
System
Overview

B1.
Cable Ties

B2.
Cable
Accessories

B3.
Stainless
Steel Ties

C1.
Wiring
Duct

C2.
Surface
Raceway

C3.
Abrasion
Protection

C4.
Cable
Management

D1.
Terminals

D2.
Power
Connectors

D3.
Grounding
Connectors

E1.
Labeling
Systems

E2.
Labels

E3.
Pre-Printed
& Write-On
Markers

E4.
Permanent
Identification

E5.
Lockout/
Tagout
& Safety
Solutions

F.
Index

A. System Overview

PANDUCT® Type G and D Wiring Duct Dimensions

Dimensions are shown for reference only. Contact PANDUIT customer service at 800-777-3300 for specific dimensional needs.

B1. Cable Ties

B2. Cable Accessories

B3. Stainless Steel Ties

C1. Wiring Duct

C2. Surface Raceway

C3. Abrasion Protection

C4. Cable Management

D1. Terminals

D2. Power Connectors

D3. Grounding Connectors

E1. Labeling Systems

E2. Labels

E3. Pre-Printed & Write-On Markers

E4. Permanent Identification

E5. Lockout/Tagout & Safety Solutions

F. Index

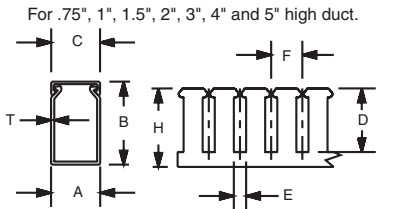
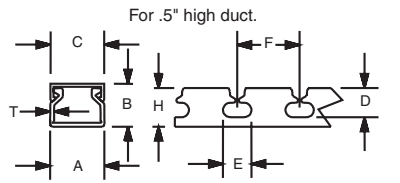

Note: 'A' dimension is measured at base.
Note: 'K' dimension shown in mounting hole dimensions below.

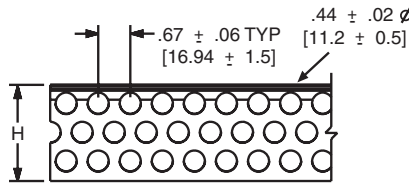

For 2" duct height = 3 rows of holes
3" duct height = 4 rows of holes
4" duct height = 6 rows of holes

Mounting Hole Dimensions
For .5", .75", 1", and 1.5" wide duct.

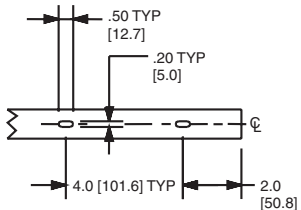

For 2.0", 2.5", 3", 4" and 6" wide duct.

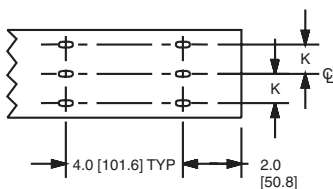

Duct Size (W x H)	Dimensions – Inches (mm)									
	A	B	C	D	E	F	H	K	T	
.5 x .5 (12.7) (12.7)	.69 (17.5)	.60 (15.2)	.69 (17.5)	.38 (9.5)	.37 (9.3)	.80 (20.3)	.50 (12.7)		.05 (1.3)	
.5 x 1 (12.7) (25.4)	.69 (17.5)	1.06 (26.9)	.69 (17.5)	.75 (19.1)	.31 (7.9)	.80 (20.3)	1.00 (25.4)		.05 (1.3)	
.5 x 2 (12.7) (50.8)	.69 (17.5)	2.03 (51.6)	.69 (17.5)	1.63 (41.3)	.31 (7.9)	.80 (20.3)	2.00 (50.8)		.08 (2.0)	
.5 x 4 (12.7) (101.6)	.69 (17.5)	4.10 (104.1)	.69 (17.5)	2.25 (57.2)	.31 (7.9)	1.00 (25.4)	4.00 (101.6)		.10 (2.4)	
.75 x .75 (19.1) (19.1)	.93 (23.6)	.82 (20.8)	.94 (23.9)	.56 (14.3)	.31 (7.9)	.80 (20.3)	0.75 (19.1)		.06 (1.4)	
.75 x 1 (19.1) (25.4)	.93 (23.6)	1.06 (26.9)	.94 (23.9)	.75 (19.1)	.31 (7.9)	.80 (20.3)	1.00 (25.4)		.06 (1.4)	
.75 x 1.5 (19.1) (38.1)	.93 (23.6)	1.57 (39.9)	.94 (23.9)	1.20 (30.5)	.31 (7.9)	.80 (20.3)	1.50 (38.1)		.07 (1.8)	
.75 x 2 (19.1) (50.8)	.93 (23.6)	2.03 (51.6)	.94 (23.9)	1.63 (41.3)	.31 (7.9)	.80 (20.3)	2.00 (50.8)		.08 (2.0)	
1 x 1 (25.4) (25.4)	1.26 (32.0)	1.12 (28.4)	1.25 (31.8)	.75 (19.1)	.31 (7.9)	.80 (20.3)	1.00 (25.4)		.06 (1.4)	
1 x 1.5 (25.4) (38.1)	1.26 (32.0)	1.62 (41.1)	1.25 (31.8)	1.20 (30.5)	.31 (7.9)	.80 (20.3)	1.50 (38.1)		.07 (1.8)	
1 x 2 (25.4) (50.8)	1.26 (32.0)	2.12 (53.8)	1.25 (31.8)	1.63 (41.3)	.31 (7.9)	.80 (20.3)	2.00 (50.8)		.08 (2.0)	
1 x 3 (25.4) (76.2)	1.26 (32.0)	3.12 (79.2)	1.25 (31.8)	2.63 (66.7)	.31 (7.9)	1.00 (25.4)	3.00 (76.2)		.10 (2.4)	
1 x 4 (25.4) (101.6)	1.26 (32.0)	4.10 (104.1)	1.25 (31.8)	3.63 (92.1)	.31 (7.9)	1.00 (25.4)	4.00 (101.6)		.11 (2.7)	
1.5 x 1 (38.1) (25.4)	1.75 (44.5)	1.12 (28.4)	1.75 (44.5)	.75 (19.1)	.31 (7.9)	.80 (20.3)	1.00 (25.4)		.06 (1.5)	
1.5 x 1.5 (38.1) (38.1)	1.75 (44.5)	1.62 (41.1)	1.75 (44.5)	1.20 (30.5)	.31 (7.9)	.80 (20.3)	1.50 (38.1)		.07 (1.8)	
1.5 x 2 (38.1) (50.8)	1.75 (44.5)	2.12 (53.8)	1.75 (44.5)	1.63 (41.3)	.31 (7.9)	.80 (20.3)	2.00 (50.8)		.08 (2.0)	
1.5 x 3 (38.1) (76.2)	1.75 (44.5)	3.12 (79.2)	1.75 (44.5)	2.63 (66.7)	.31 (7.9)	1.00 (25.4)	3.00 (76.2)		.10 (2.4)	
1.5 x 4 (38.1) (101.6)	1.75 (44.5)	4.10 (104.1)	1.75 (44.5)	3.63 (92.1)	.31 (7.9)	1.00 (25.4)	4.00 (101.6)		.11 (2.7)	
2 x 1 (50.8) (25.4)	2.25 (57.2)	1.12 (28.4)	2.25 (57.2)	.75 (19.1)	.31 (7.9)	.80 (20.3)	1.00 (25.4)	.50 (12.7)	.06 (1.5)	
2 x 1.5 (50.8) (38.1)	2.25 (57.2)	1.62 (41.1)	2.25 (57.2)	1.20 (30.5)	.31 (7.9)	.80 (20.3)	1.50 (38.1)	.50 (12.7)	.07 (1.8)	
2 x 2 (50.8) (50.8)	2.25 (57.2)	2.12 (53.8)	2.25 (57.2)	1.63 (41.3)	.31 (7.9)	.80 (20.3)	2.00 (50.8)	.50 (12.7)	.08 (2.0)	
2 x 3 (50.8) (76.2)	2.25 (57.2)	3.12 (79.2)	2.25 (57.2)	2.63 (66.7)	.31 (7.9)	1.00 (25.4)	3.00 (76.2)	.50 (12.7)	.10 (2.4)	
2 x 4 (50.8) (101.6)	2.25 (57.2)	4.10 (104.1)	2.25 (57.2)	3.63 (92.1)	.31 (7.9)	1.00 (25.4)	4.00 (101.6)	.50 (12.7)	.11 (2.7)	
2 x 5 (50.8) (127.0)	2.25 (57.2)	5.10 (129.5)	2.25 (57.2)	4.63 (117.5)	.38 (9.5)	1.33 (33.9)	5.00 (127.0)	.50 (12.7)	.12 (2.9)	
2.5 x 3 (63.5) (76.2)	2.75 (69.9)	3.12 (79.2)	2.75 (69.9)	2.63 (66.7)	.31 (7.9)	1.00 (25.4)	3.00 (76.2)	.73 (18.4)	.10 (2.5)	
3 x 1 (76.2) (25.4)	3.25 (82.6)	1.12 (28.4)	3.25 (82.6)	.75 (19.1)	.31 (7.9)	.80 (20.3)	1.00 (25.4)	1.00 (25.4)	.07 (1.8)	
3 x 2 (76.2) (50.8)	3.25 (82.6)	2.12 (53.8)	3.25 (82.6)	1.63 (41.3)	.31 (7.9)	.80 (20.3)	2.00 (50.8)	1.00 (25.4)	.08 (2.0)	
3 x 3 (76.2) (76.2)	3.25 (82.6)	3.12 (79.2)	3.25 (82.6)	2.63 (66.7)	.31 (7.9)	1.00 (25.4)	3.00 (76.2)	1.00 (25.4)	.10 (2.4)	
3 x 4 (76.2) (101.6)	3.25 (82.6)	4.10 (104.1)	3.25 (82.6)	3.63 (92.1)	.31 (7.9)	1.00 (25.4)	4.00 (101.6)	1.00 (25.4)	.11 (2.7)	
3 x 5 (76.2) (127.0)	3.25 (82.6)	5.10 (129.5)	3.25 (82.6)	4.63 (117.5)	.38 (9.5)	1.33 (33.9)	5.00 (127.0)	1.00 (25.4)	.12 (2.9)	
4 x 1.5 (101.6) (38.1)	4.25 (108.0)	1.62 (41.1)	4.25 (108.0)	1.20 (30.5)	.31 (7.9)	.80 (20.3)	1.50 (38.1)	1.50 (38.1)	.07 (1.8)	
4 x 2 (101.6) (50.8)	4.25 (108.0)	2.12 (53.8)	4.25 (108.0)	1.63 (41.3)	.31 (7.9)	0.80 (20.3)	2.00 (50.8)	1.50 (38.1)	.08 (2.0)	
4 x 3 (101.6) (76.2)	4.25 (108.0)	3.12 (79.2)	4.25 (108.0)	2.63 (66.7)	.31 (7.9)	1.00 (25.4)	3.00 (76.2)	1.50 (38.1)	.10 (2.5)	
4 x 4 (101.6) (101.6)	4.25 (108.0)	4.10 (104.1)	4.25 (108.0)	3.63 (92.1)	.31 (7.9)	1.00 (25.4)	4.00 (101.6)	1.50 (38.1)	.11 (2.7)	
4 x 5 (101.6) (127.0)	4.25 (108.0)	5.10 (129.5)	4.25 (108.0)	4.63 (117.5)	.38 (9.5)	1.33 (33.9)	5.00 (127.0)	1.50 (38.1)	.12 (2.9)	
6 x 4 (152.4) (101.6)	6.25 (158.8)	4.15 (105.4)	6.25 (158.8)	3.63 (92.1)	.31 (7.9)	1.00 (25.4)	4.00 (101.6)	2.50 (63.5)	.11 (2.8)	

ON CENTERLINE

> Available for type G wiring duct only.
See page C1.9 and C1.13 for wiring duct color and size availability.

PANDUCT® Type F Wiring Duct and FS Raceway Dimensions

Dimensions are shown for reference only. Contact PANDUIT customer service at 800-777-3300 for specific dimensional needs.

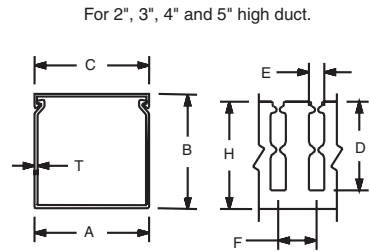
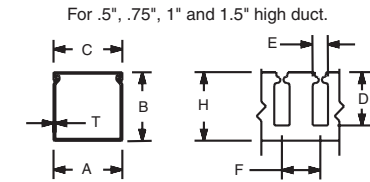

Note: 'A' dimension is measured at base.
Note: 'K' dimension shown in mounting hole dimensions below.

Mounting Hole Dimensions
For .5", .75", 1" and 1.5" wide duct.

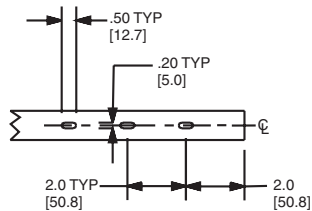

For 2.0", 2.5", 3", 4" and 6" wide duct.

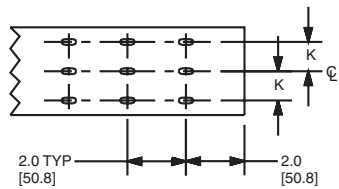

Note: For type FS raceway, no mounting holes is the standard condition; if mounting holes are required, delete NM from the part number.

Duct Size (W x H)	Dimensions – Inches (mm)								
	A	B	C	D	E	F	H	K	T
.5 x .5 (12.7) (12.7)	.69 (17.5)	.60 (15.2)	.69 (17.5)	.38 (9.5)	.20 (5.0)	.50 (12.7)	.50 (12.7)	ON CENTERLINE	.05 (1.3)
.5 x 1 (12.7) (25.4)	.69 (17.5)	1.06 (26.9)	.69 (17.5)	.75 (19.1)	.20 (5.0)	.50 (12.7)	1.00 (25.4)		.05 (1.3)
.75 x .75 (19.1) (19.1)	.93 (23.6)	.82 (20.8)	.94 (23.9)	.56 (14.3)	.20 (5.0)	.50 (12.7)	.75 (19.1)		.06 (1.4)
.75 x 1.5 (19.1) (38.1)	.93 (23.6)	1.57 (39.9)	.94 (23.9)	1.20 (30.5)	.20 (5.0)	.50 (12.7)	1.50 (38.1)		.07 (1.8)
1 x 1 (25.4) (25.4)	1.26 (32.0)	1.12 (28.4)	1.25 (31.8)	.75 (19.1)	.20 (5.0)	.50 (12.7)	1.00 (25.4)		.06 (1.4)
1 x 1.5 (25.4) (38.1)	1.26 (32.0)	1.62 (41.1)	1.25 (31.8)	1.20 (30.5)	.20 (5.0)	.50 (12.7)	1.50 (38.1)		.07 (1.8)
1 x 2 (25.4) (50.8)	1.26 (32.0)	2.12 (53.8)	1.25 (31.8)	1.63 (41.3)	.20 (5.0)	.50 (12.7)	2.00 (50.8)		.08 (2.0)
1 x 3 (25.4) (76.2)	1.26 (32.0)	3.12 (79.2)	1.25 (31.8)	2.63 (66.7)	.20 (5.0)	.50 (12.7)	3.00 (76.2)		.10 (2.4)
1 x 4 (25.4) (101.6)	1.26 (32.0)	4.10 (104.1)	1.25 (31.8)	3.63 (92.1)	.20 (5.0)	.50 (12.7)	4.00 (101.6)		.11 (2.7)
1.5 x 1 (38.1) (25.4)	1.75 (44.5)	1.12 (28.4)	1.75 (44.5)	.75 (19.1)	.20 (5.0)	.50 (12.7)	1.00 (25.4)		.06 (1.5)
1.5 x 1.5 (38.1) (38.1)	1.75 (44.5)	1.62 (41.1)	1.75 (44.5)	1.20 (30.5)	.20 (5.0)	.50 (12.7)	1.50 (38.1)		.07 (1.8)
1.5 x 2 (38.1) (50.8)	1.75 (44.5)	2.12 (53.8)	1.75 (44.5)	1.63 (41.3)	.20 (5.0)	.50 (12.7)	2.00 (50.8)		.08 (2.0)
1.5 x 3 (38.1) (76.2)	1.75 (44.5)	3.12 (79.2)	1.75 (44.5)	2.63 (66.7)	.20 (5.0)	.50 (12.7)	3.00 (76.2)		.10 (2.4)
1.5 x 4 (38.1) (101.6)	1.75 (44.5)	4.10 (104.1)	1.75 (44.5)	3.63 (92.1)	.20 (5.0)	.50 (12.7)	4.00 (101.6)		.11 (2.7)
2 x 1 (50.8) (25.4)	2.25 (57.2)	1.12 (28.4)	2.25 (57.2)	.75 (19.1)	.20 (5.0)	.50 (12.7)	1.00 (25.4)		.06 (1.5)
2 x 1.5 (50.8) (38.1)	2.25 (57.2)	1.62 (41.1)	2.25 (57.2)	1.20 (30.5)	.20 (5.0)	.50 (12.7)	1.50 (38.1)		.07 (1.8)
2 x 2 (50.8) (50.8)	2.25 (57.2)	2.12 (53.8)	2.25 (57.2)	1.63 (41.3)	.20 (5.0)	.50 (12.7)	2.00 (50.8)		.08 (2.0)
2 x 3 (50.8) (76.2)	2.25 (57.2)	3.12 (79.2)	2.25 (57.2)	2.63 (66.7)	.20 (5.0)	.50 (12.7)	3.00 (76.2)		.10 (2.4)
2 x 4 (50.8) (101.6)	2.25 (57.2)	4.10 (104.1)	2.25 (57.2)	3.63 (92.1)	.20 (5.0)	.50 (12.7)	4.00 (101.6)		.11 (2.7)
2 x 5 (50.8) (127.0)	2.25 (57.2)	5.10 (129.5)	2.25 (57.2)	4.63 (117.5)	.20 (5.0)	.50 (12.7)	5.00 (127.0)		.12 (2.9)
3 x 1 (76.2) (25.4)	3.25 (82.6)	1.12 (28.4)	3.25 (82.6)	.75 (19.1)	.20 (5.0)	.50 (12.7)	1.00 (25.4)		.07 (1.7)
3 x 2 (76.2) (50.8)	3.25 (82.6)	2.12 (53.8)	3.25 (82.6)	1.63 (41.3)	.20 (5.0)	.50 (12.7)	2.00 (50.8)		.08 (2.0)
3 x 3 (76.2) (76.2)	3.25 (82.6)	3.12 (79.2)	3.25 (82.6)	2.63 (66.7)	.20 (5.0)	.50 (12.7)	3.00 (76.2)		.10 (2.4)
3 x 4 (76.2) (101.6)	3.25 (82.6)	4.10 (104.1)	3.25 (82.6)	3.63 (92.1)	.20 (5.0)	.50 (12.7)	4.00 (101.6)		.11 (2.7)
3 x 5 (76.2) (127.0)	3.25 (82.6)	5.10 (129.5)	3.25 (82.6)	4.63 (117.5)	.20 (5.0)	.50 (12.7)	5.00 (127.0)	.12 (2.9)	
4 x 1.5 (101.6) (38.1)	4.25 (108.0)	1.62 (41.1)	4.25 (108.0)	N/A	N/A	N/A	1.50 (38.1)	.07 (1.8)	
4 x 2 (101.6) (50.8)	4.25 (108.0)	2.12 (53.8)	4.25 (108.0)	1.63 (41.3)	.20 (5.0)	.50 (12.7)	2.00 (50.8)	.08 (2.0)	
4 x 3 (101.6) (76.2)	4.25 (108.0)	3.12 (79.2)	4.25 (108.0)	2.63 (66.7)	.20 (5.0)	.50 (12.7)	3.00 (76.2)	.10 (2.4)	
4 x 4 (101.6) (101.6)	4.25 (108.0)	4.10 (104.1)	4.25 (108.0)	3.63 (92.1)	.20 (5.0)	.50 (12.7)	4.00 (101.6)	.11 (2.7)	
4 x 5 (101.6) (127.0)	4.25 (108.0)	5.10 (129.5)	4.25 (108.0)	4.63 (117.5)	.20 (5.0)	.50 (12.7)	5.00 (127.0)	.12 (2.9)	
6 x 4 (152.4) (101.6)	6.25 (158.8)	4.15 (105.4)	6.25 (158.8)	N/A	N/A	N/A	4.00 (101.6)	.11 (2.8)	

> Available for type FS raceway only.
See page C1.48 for wiring duct color and size availability.

A.
System
Overview

B1.
Cable Ties

B2.
Cable
Accessories

B3.
Stainless
Steel Ties

C1.
Wiring
Duct

C2.
Surface
Raceway

C3.
Abrasion
Protection

C4.
Cable
Management

D1.
Terminals

D2.
Power
Connectors

D3.
Grounding
Connectors

E1.
Labeling
Systems

E2.
Labels

E3.
Pre-Printed
& Write-On
Markers

E4.
Permanent
Identification

E5.
Lockout/
Tagout
& Safety
Solutions

F.
Index

A. System Overview

PANDUCT® Type MC and TMC Wiring Duct Dimensions

Dimensions are shown for reference only. Contact PANDUIT customer service at 800-777-3300 for specific dimensional needs.

B1. Cable Ties

B2. Cable Accessories

B3. Stainless Steel Ties

C1. Wiring Duct

C2. Surface Raceway

C3. Abrasion Protection

C4. Cable Management

D1. Terminals

D2. Power Connectors

D3. Grounding Connectors

E1. Labeling Systems

E2. Labels

E3. Pre-Printed & Write-On Markers

E4. Permanent Identification

E5. Lockout/Tagout & Safety Solutions

F. Index

For 25mm, 37.5mm, and 50mm high duct.

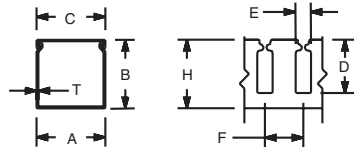

For 62.5mm, 75mm, and 100mm high duct.

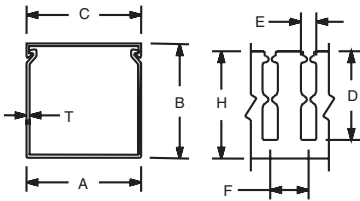

Note: 'A' dimension is measured at base.
Note: 'K' dimension shown in mounting hole dimensions below.

Mounting Hole Dimensions
For 25mm, 37.5mm, and 50mm width duct.

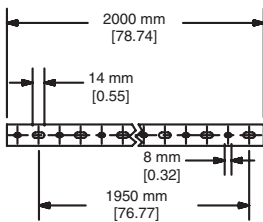

For 75mm and 100mm width duct.

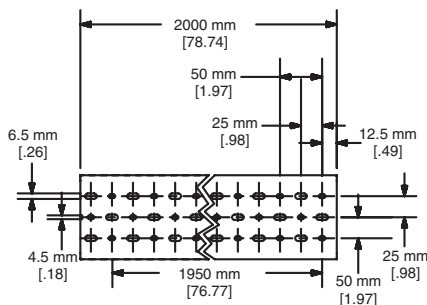

Duct Size (W x H)	Dimensions – mm (Inches)							
	A	B	C	D	E	F	H	T
25 x 25 (.98) x (.98)	24.6 (.97)	23.6 (.93)	24.6 (.97)	13.6 (.54)	5.0 (.20)	12.5 (.49)	20.5 (.81)	1.4 (.06)
25 x 37.5 (.98) x (1.48)	24.6 (.97)	35.8 (1.41)	24.6 (.97)	24.7 (.97)	5.0 (.20)	12.5 (.49)	33.0 (1.30)	1.4 (.06)
25 x 50 (.98) x (1.97)	24.6 (.97)	47.8 (1.88)	24.6 (.97)	34.8 (1.37)	5.0 (.20)	12.5 (.49)	45.5 (1.79)	1.5 (.06)
25 x 62.5 (.98) x (2.46)	24.6 (.97)	59.7 (2.35)	24.6 (.97)	45.8 (1.80)	5.0 (.20)	12.5 (.49)	58.0 (2.28)	1.5 (.06)
25 x 75 (.98) x (2.95)	24.6 (.97)	73.2 (2.88)	24.6 (.97)	57.6 (2.27)	5.0 (.20)	12.5 (.49)	70.5 (2.78)	1.7 (.07)
37.5 x 37.5 (1.48) x (1.48)	37.1 (1.46)	35.8 (1.41)	37.1 (1.46)	24.7 (.97)	5.0 (.20)	12.5 (.49)	33.0 (1.30)	1.5 (.06)
37.5 x 50 (1.48) x (1.97)	37.1 (1.46)	47.8 (1.88)	37.1 (1.46)	34.8 (1.37)	5.0 (.20)	12.5 (.49)	45.5 (1.79)	1.7 (.07)
37.5 x 62.5 (1.48) x (2.46)	37.1 (1.46)	59.7 (2.35)	37.1 (1.46)	45.8 (1.80)	5.0 (.20)	12.5 (.49)	58.0 (2.28)	1.7 (.07)
37.5 x 75 (1.48) x (2.95)	37.1 (1.46)	72.4 (2.85)	37.1 (1.46)	57.6 (2.27)	5.0 (.20)	12.5 (.49)	70.5 (2.78)	1.8 (.07)
50 x 50 (1.97) x (1.97)	49.5 (1.95)	48.0 (1.89)	49.6 (1.95)	34.8 (1.37)	5.0 (.20)	12.5 (.49)	45.5 (1.79)	1.7 (.07)
50 x 75 (1.97) x (2.95)	49.5 (1.95)	72.4 (2.85)	49.6 (1.95)	57.6 (2.27)	5.0 (.20)	12.5 (.49)	70.5 (2.78)	1.9 (.08)
50 x 100 (1.97) x (3.94)	49.5 (1.95)	97.8 (3.85)	49.6 (1.95)	81.0 (3.19)	5.0 (.20)	12.5 (.49)	95.5 (3.76)	2.2 (.09)
62.5 x 37.5 (2.46) x (1.48)	62.0 (2.44)	35.8 (1.41)	62.1 (2.44)	24.7 (.97)	5.0 (.20)	12.5 (.49)	33.0 (1.30)	1.7 (.07)
62.5 x 62.5 (2.46) x (2.46)	62.0 (2.44)	59.7 (2.35)	62.1 (2.44)	45.8 (1.80)	5.0 (.20)	12.5 (.49)	58.0 (2.28)	1.8 (.07)
75 x 50 (2.95) x (1.97)	74.7 (2.94)	48.0 (1.89)	74.6 (2.94)	34.8 (1.37)	5.0 (.20)	12.5 (.49)	45.5 (1.79)	2.0 (.08)
75 x 62.5 (2.95) x (2.46)	74.7 (2.94)	59.7 (2.35)	74.6 (2.94)	45.8 (1.80)	5.0 (.20)	12.5 (.49)	58.0 (2.28)	2.0 (.08)
75 x 75 (2.95) x (2.95)	74.7 (2.94)	73.2 (2.88)	74.6 (2.94)	57.6 (2.27)	5.0 (.20)	12.5 (.49)	70.5 (2.78)	2.2 (.09)
75 x 100 (2.95) x (3.94)	74.7 (2.94)	97.8 (3.85)	74.6 (2.94)	81.0 (3.19)	5.0 (.20)	12.5 (.49)	95.5 (3.76)	2.3 (.09)
100 x 50 (3.94) x (1.97)	99.6 (3.92)	48.0 (1.89)	99.6 (3.92)	34.8 (1.37)	5.0 (.20)	12.5 (.49)	45.5 (1.79)	2.0 (.08)
100 x 62.5 (3.94) x (2.46)	99.6 (3.92)	59.7 (2.35)	99.6 (3.92)	45.8 (1.80)	5.0 (.20)	12.5 (.49)	58.0 (2.28)	2.0 (.08)
100 x 75 (3.94) x (2.95)	99.6 (3.92)	73.2 (2.88)	99.6 (3.92)	57.6 (2.27)	5.0 (.20)	12.5 (.49)	70.5 (2.78)	2.5 (.10)
100 x 100 (3.94) x (3.94)	99.6 (3.92)	97.8 (3.85)	99.6 (3.92)	81.0 (3.19)	5.0 (.20)	12.5 (.49)	99.5 (3.76)	2.5 (.10)

> Available for type MC wiring duct only.

PANDUCT® Type NNC Wiring Duct Dimensions

Dimensions are shown for reference only. Contact PANDUIT customer service at 800-777-3300 for specific dimensional needs.

For 25mm, 37.5mm, and 50mm high duct.

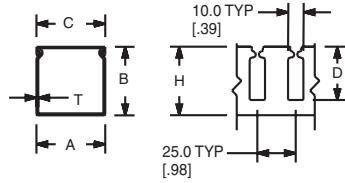

For 75mm and 100mm high duct.

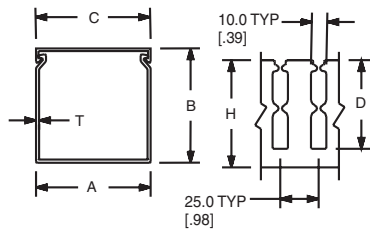

Mounting Hole Dimensions

For 25mm, 37.5mm, and 50mm width duct.

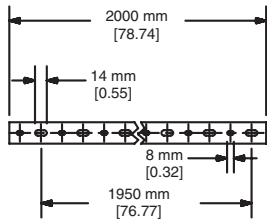

For 75mm and 100mm width duct.

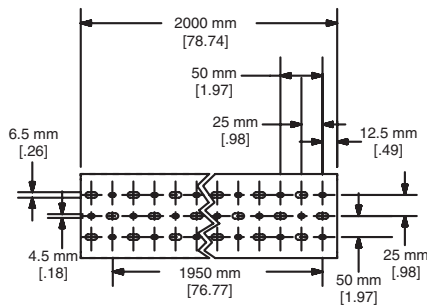

Duct Size (W x H)	Dimensions – mm (Inches)					
	A	B	C	D	H	T
25 x 25 (.98) x (.98)	24.6 (.97)	23.6 (.93)	24.6 (.97)	13.6 (.54)	20.3 (.80)	1.5 (.06)
25 x 37 (.98) x (1.48)	24.6 (.97)	35.8 (1.41)	24.6 (.97)	24.6 (.97)	33.0 (1.30)	1.8 (.07)
25 x 50 (.98) x (1.97)	24.6 (.97)	47.8 (1.88)	24.6 (.97)	34.8 (1.37)	45.5 (1.79)	2.0 (.08)
25 x 75 (.98) x (2.95)	24.6 (.97)	72.4 (2.85)	24.6 (.97)	57.6 (2.27)	70.6 (2.78)	2.0 (.08)
37.5 x 37.5 (1.48) x (1.48)	37.1 (1.46)	35.8 (1.41)	37.1 (1.46)	24.7 (.97)	33.0 (1.30)	1.8 (.07)
37.5 x 50 (1.48) x (1.97)	37.1 (1.46)	47.8 (1.88)	37.1 (1.46)	34.8 (1.37)	45.5 (1.79)	2.0 (.08)
37.5 x 75 (1.48) x (2.95)	37.1 (1.46)	72.4 (2.85)	37.1 (1.46)	57.6 (2.27)	70.6 (2.78)	2.0 (.08)
50 x 50 (1.97) x (1.97)	49.5 (1.95)	47.8 (1.88)	49.5 (1.95)	34.8 (1.37)	45.5 (1.79)	2.0 (.08)
50 x 75 (1.97) x (2.95)	49.5 (1.95)	72.4 (2.85)	49.5 (1.95)	57.6 (2.27)	70.6 (2.78)	2.0 (.08)
50 x 100 (1.97) x (3.94)	49.5 (1.95)	97.8 (3.85)	49.5 (1.95)	81.0 (3.19)	95.5 (3.76)	2.3 (.09)
75 x 75 (2.95) x (2.95)	74.7 (2.94)	72.4 (2.85)	74.7 (2.94)	57.6 (2.27)	70.6 (2.78)	2.0 (.08)
100 x 50 (3.94) x (1.97)	99.6 (3.92)	47.8 (1.88)	99.6 (3.92)	34.8 (1.37)	45.5 (1.79)	2.0 (.08)
100 x 75 (3.94) x (2.95)	99.6 (3.92)	72.4 (2.85)	99.6 (3.92)	57.6 (2.27)	70.6 (2.78)	2.0 (.08)
100 x 100 (3.92) x (3.85)	99.6 (3.92)	97.8 (3.85)	99.6 (3.92)	81.0 (3.19)	95.5 (3.76)	2.3 (.09)

A.
System
Overview

B1.
Cable Ties

B2.
Cable
Accessories

B3.
Stainless
Steel Ties

C1.
Wiring
Duct

C2.
Surface
Raceway

C3.
Abrasion
Protection

C4.
Cable
Management

D1.
Terminals

D2.
Power
Connectors

D3.
Grounding
Connectors

E1.
Labeling
Systems

E2.
Labels

E3.
Pre-Printed
& Write-On
Markers

E4.
Permanent
Identification

E5.
Lockout/
Tagout/
& Safety
Solutions

F.
Index

A. System Overview

PANDUCT® Type NE Wiring Duct Dimensions

Dimensions are shown for reference only. Contact PANDUIT customer service at 800-777-3300 for specific dimensional needs.

B1. Cable Ties

B2. Cable Accessories

B3. Stainless Steel Ties

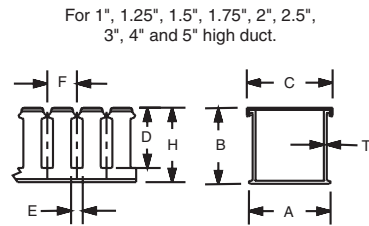
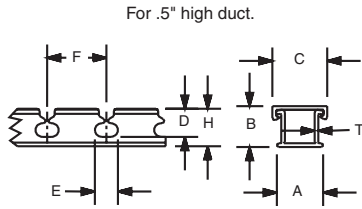

C1. Wiring Duct

C2. Surface Raceway

C3. Abrasion Protection

C4. Cable Management

Mounting Hole Dimensions
For .5", .75", 1" and 1.5" wide duct.

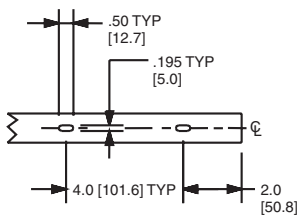

D1. Terminals

D2. Power Connectors

D3. Grounding Connectors

For 2.0", 2.5", 3" and 4" wide duct.

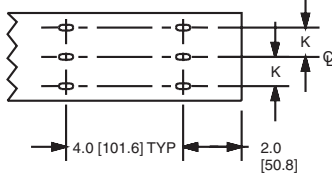

E1. Labeling Systems

E2. Labels

E3. Pre-Printed & Write-On Markers

E4. Permanent Identification

E5. Lockout/ Tagout & Safety Solutions

F. Index

Duct Size (W x H)	Dimensions – Inches (mm)								
	A	B	C	D	E	F	H	K	T
.5 x .5 (12.7) (12.7)	.63 (16.0)	.56 (14.2)	.69 (17.5)	.38 (9.7)	.37 (9.4)	.80 (20.3)	.50 (12.7)	ON CENTERLINE	.05 (1.3)
.5 x 1 (12.7) (25.4)	.63 (16.0)	1.06 (26.9)	.69 (17.5)	.75 (19.1)	.31 (7.9)	.80 (20.3)	1.00 (25.4)		.06 (1.5)
1 x 1 (25.4) (25.4)	1.14 (29.0)	1.06 (26.9)	1.25 (31.8)	.75 (19.1)	.31 (7.9)	.80 (20.3)	1.00 (25.4)		.06 (1.5)
1 x 1.5 (25.4) (38.1)	1.14 (29.0)	1.62 (41.1)	1.25 (31.8)	1.20 (30.5)	.31 (7.9)	.80 (20.3)	1.50 (38.1)		.07 (1.8)
1 x 2 (25.4) (50.8)	1.14 (29.0)	2.06 (52.3)	1.25 (31.8)	1.63 (41.4)	.31 (7.9)	.80 (20.3)	2.00 (50.8)		.07 (1.8)
1 x 3 (25.4) (76.2)	1.14 (29.0)	3.06 (77.7)	1.25 (31.8)	2.63 (66.8)	.31 (7.9)	1.00 (25.4)	3.00 (76.2)		.07 (1.8)
1 x 4 (25.4) (101.6)	1.14 (29.0)	4.06 (103.1)	1.25 (31.8)	3.63 (92.2)	.31 (7.9)	1.00 (25.4)	4.00 (101.6)		.08 (2.0)
1.5 x 1.5 (38.1) (38.1)	1.64 (41.7)	1.62 (41.1)	1.75 (44.5)	1.20 (30.5)	.31 (7.9)	.80 (20.3)	1.50 (38.1)		.07 (1.8)
1.5 x 2 (38.1) (50.8)	1.64 (41.7)	2.06 (52.3)	1.75 (44.5)	1.63 (41.4)	.31 (7.9)	.80 (20.3)	2.00 (50.8)		.07 (1.8)
1.5 x 3 (38.1) (76.2)	1.64 (41.7)	3.06 (77.7)	1.75 (44.5)	2.63 (66.8)	.31 (7.9)	1.00 (25.4)	3.00 (76.2)		.07 (1.8)
1.5 x 4 (38.1) (101.6)	1.64 (41.7)	4.06 (103.1)	1.75 (44.5)	3.63 (92.2)	.31 (7.9)	1.00 (25.4)	4.00 (101.6)		.08 (2.0)
2 x 1 (50.8) (25.4)	2.14 (54.4)	1.06 (26.9)	2.25 (57.2)	.75 (19.1)	.31 (7.9)	.80 (20.3)	1.00 (25.4)		.06 (1.5)
2 x 2 (50.8) (50.8)	2.14 (54.4)	2.06 (52.3)	2.25 (57.2)	1.63 (41.4)	.31 (7.9)	.80 (20.3)	2.00 (50.8)		.07 (1.8)
2 x 3 (50.8) (76.2)	2.14 (54.4)	3.06 (77.7)	2.25 (57.2)	2.63 (66.8)	.31 (7.9)	1.00 (25.4)	3.00 (76.2)		.07 (1.8)
2 x 4 (50.8) (101.6)	2.14 (54.4)	4.06 (103.1)	2.25 (57.2)	3.63 (92.2)	.31 (7.9)	1.00 (25.4)	4.00 (101.6)		.08 (2.0)
3 x 1 (76.2) (25.4)	3.14 (79.8)	1.06 (26.9)	3.25 (82.6)	.75 (19.1)	.31 (7.9)	.80 (20.3)	1.00 (25.4)		.06 (1.5)
3 x 2 (76.2) (50.8)	3.14 (79.8)	2.06 (52.3)	3.25 (82.6)	1.63 (41.4)	.31 (7.9)	.80 (20.3)	2.00 (50.8)		.07 (1.7)
3 x 3 (76.2) (76.2)	3.14 (79.8)	3.06 (77.7)	3.25 (82.6)	2.63 (66.8)	.31 (7.9)	1.00 (25.4)	3.00 (76.2)		.07 (1.8)
3 x 4 (76.2) (101.6)	3.14 (79.8)	4.06 (103.1)	3.25 (82.6)	3.63 (92.2)	.31 (7.9)	1.00 (25.4)	4.00 (101.6)		.08 (2.0)
3 x 5 (76.2) (127.0)	3.14 (79.8)	5.06 (128.5)	3.25 (82.6)	4.63 (117.6)	.38 (9.7)	1.33 (33.8)	5.00 (127.0)		.09 (2.3)
4 x 2 (101.6) (50.8)	4.14 (105.2)	2.06 (52.3)	4.25 (108.0)	1.63 (41.4)	.31 (7.9)	.80 (20.3)	2.00 (50.8)	.07 (1.8)	
4 x 3 (101.6) (76.2)	4.14 (105.2)	3.06 (77.7)	4.25 (108.0)	2.63 (66.8)	.31 (7.9)	1.00 (25.4)	3.00 (76.2)	.07 (1.8)	
4 x 4 (101.6) (101.6)	4.14 (105.2)	4.06 (103.1)	4.25 (108.0)	3.63 (92.2)	.31 (7.9)	1.00 (25.4)	4.00 (101.6)	.08 (2.0)	
4 x 5 (101.6) (127.0)	4.14 (105.2)	5.06 (128.5)	4.25 (108.0)	4.63 (117.6)	.38 (9.7)	1.33 (33.8)	5.00 (127.0)	.09 (2.3)	

PANDUCT® Type H and HS Wiring Duct Dimensions

Dimensions are shown for reference only. Contact PANDUIT customer service at 800-777-3300 for specific dimensional needs.

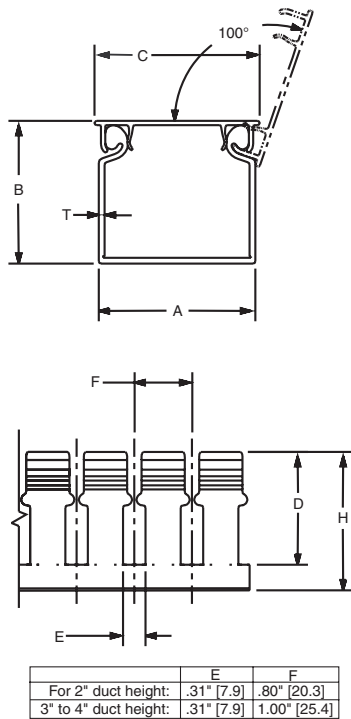

Duct Size (W x H)	Dimensions – Inches (mm)								
	A	B	C	D	E	F	H	K	T
1.5 x 2 (38.1) x (50.8)	1.75 (44.5)	1.98 (50.3)	1.88 (47.8)	1.63 (41.4)	.31 (7.9)	.80 (20.3)	1.92 (48.8)	On CL	.08 (2.0)
1.5 x 3 (38.1) x (76.2)	1.75 (44.5)	3.06 (77.7)	1.88 (47.8)	2.63 (66.8)	.31 (7.9)	1.00 (25.4)	3.00 (76.2)		.10 (2.5)
2 x 2 (50.8) x (50.8)	2.17 (55.1)	1.98 (50.3)	2.29 (58.2)	1.57 (39.9)	.31 (7.9)	.80 (20.3)	1.92 (48.8)	.50 (12.7)	.08 (2.0)
2 x 3 (50.8) x (76.2)	2.17 (55.1)	3.06 (77.7)	2.29 (58.2)	2.63 (66.8)	.31 (7.9)	1.00 (25.4)	3.00 (76.2)	.50 (12.7)	.10 (2.5)
2 x 4 (50.8) x (101.6)	2.17 (55.1)	4.1 (104.1)	4.38 (111.3)	3.63 (92.2)	.31 (7.9)	1.00 (25.4)	4.00 (101.6)	.50 (12.7)	.10 (2.7)
3 x 3 (76.2) x (76.2)	3.25 (82.6)	3.06 (77.7)	3.38 (85.9)	2.63 (66.8)	.31 (7.9)	1.00 (25.4)	3.00 (76.2)	1.00 (25.4)	.10 (2.5)
3 x 4 (76.2) x (101.6)	3.25 (82.6)	4.1 (104.1)	3.38 (85.9)	3.63 (92.2)	.31 (7.9)	1.00 (25.4)	4.00 (101.6)	1.00 (25.4)	.11 (2.8)
4 x 4 (101.6) x (101.6)	4.25 (108.0)	4.1 (104.1)	4.38 (111.3)	3.63 (92.2)	.31 (7.9)	1.00 (25.4)	4.00 (101.6)	1.50 (38.1)	.11 (2.8)

For 2", 3", and 4" wide duct.

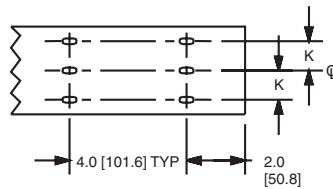

PANDUCT® Type HN Wiring Duct Dimensions

Dimensions are shown for reference only. Contact PANDUIT customer service at 800-777-3300 for specific dimensional needs.

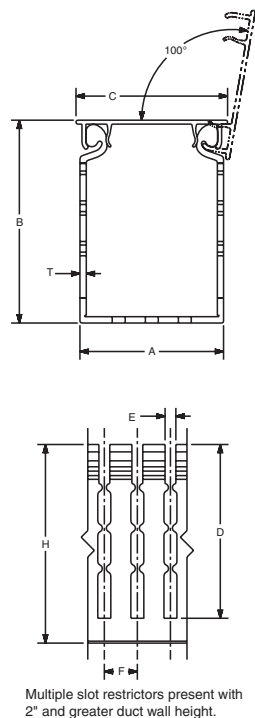

Duct Size (W x H)	Dimensions – Inches (mm)								
	A	B	C	D	E	F	H	K	T
1.5 x 2 (38.1) x (50.8)	1.75 (44.5)	1.98 (50.3)	1.88 (47.8)	1.63 (41.4)	.20 (5.0)	.50 (12.7)	1.92 (48.8)	On CL	.08 (2.0)
1.5 x 3 (38.1) x (76.2)	1.75 (44.5)	3.06 (77.7)	1.88 (47.8)	2.63 (66.8)	.20 (5.0)	.50 (12.7)	3.00 (76.2)		.10 (2.5)
2 x 2 (50.8) x (50.8)	2.17 (55.1)	1.98 (50.3)	2.29 (58.2)	1.57 (39.9)	.20 (5.0)	.50 (12.7)	1.92 (48.8)	.50 (12.7)	.08 (2.0)
2 x 3 (50.8) x (76.2)	2.17 (55.1)	3.06 (77.7)	2.29 (58.2)	2.63 (66.8)	.20 (5.0)	.50 (12.7)	3.00 (76.2)	.50 (12.7)	.10 (2.5)
2 x 4 (50.8) x (101.6)	2.17 (55.1)	4.1 (104.1)	4.38 (111.3)	3.63 (92.2)	.20 (5.0)	.50 (12.7)	4.00 (101.6)	.50 (12.7)	.10 (2.7)
3 x 3 (76.2) x (76.2)	3.25 (82.6)	3.06 (77.7)	3.38 (85.9)	2.63 (66.8)	.20 (5.0)	.50 (12.7)	3.00 (76.2)	1.00 (25.4)	.10 (2.5)
3 x 4 (76.2) x (101.6)	3.25 (82.6)	4.1 (104.1)	3.38 (85.9)	3.63 (92.2)	.20 (5.0)	.50 (12.7)	4.00 (101.6)	1.00 (25.4)	.11 (2.8)
4 x 4 (101.6) x (101.6)	4.25 (108.0)	4.1 (104.1)	4.38 (111.3)	3.63 (92.2)	.20 (5.0)	.50 (12.7)	4.00 (101.6)	1.50 (38.1)	.11 (2.8)

For 2", 3", and 4" wide duct.

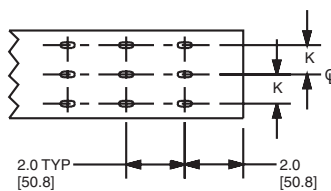

Multiple slot restrictors present with 2" and greater duct wall height.

A. System Overview

PANDUCT® Type FL Wiring Duct Dimensions

Dimensions are shown for reference only.
Dimensions are in mm (in.). Contact PANDUIT customer service at 800-777-3300 for specific dimensional needs.

B1. Cable Ties

B2. Cable Accessories

B3. Stainless Steel Ties

C1. Wiring Duct

C2. Surface Raceway

C3. Abrasion Protection

C4. Cable Management

D1. Terminals

D2. Power Connectors

D3. Grounding Connectors

E1. Labeling Systems

E2. Labels

E3. Pre-Printed & Write-On Markers

E4. Permanent Identification

E5. Lockout/Tagout & Safety Solutions

F. Index

Mounting Hole Dimensions For FL12X12LG-A

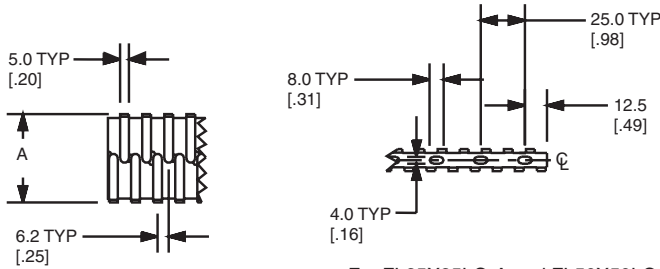

For FL25X25LG-A and FL50X50LG-A

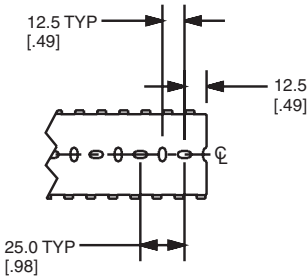

Nominal Duct Size (W x H) mm	Dimensions – mm (In.)	
	A	B
12 x 12 (.49) x (.49)	12.4 (.49)	12.4 (.49)
25 x 25 (.98) x (.98)	24.9 (.98)	24.9 (.98)
50 x 50 (1.97) x (1.97)	50 (1.97)	50 (1.97)

Note: Type FL wiring duct has factory applied adhesive. For 50 x 50 two strips of tape are used; otherwise, only one strip is centered on the part.

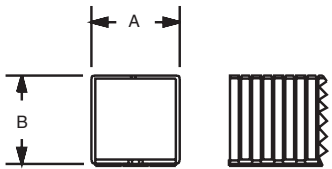

Note: 'B' dimension is without adhesive.

PANDUCT® PANELMAX™ Corner Wiring Duct – Wirefill Capacity

Nominal Duct Size (W x H) In.	Area In. ²	Electrical															Communication				
		8 AWG		10 AWG		12 AWG		14 AWG		16 AWG		18 AWG		22 AWG		23 AWG	23/24 AWG	24 AWG	Fiber Cable		
		.216	.164	.130	.141	.152	.111	.124	.133	.096	.111	.118	.084	.100	.106	.085	.330	.250	.190	.118	
CWD3	4.4 x 3.6	17.580	188	326	520	442	380	713	571	496	953	713	631	1245	879	782	1216	80	140	243	630
CWD4	5.4 x 4.6	26.920	288	500	796	677	582	1092	875	760	1460	1092	966	1907	1346	1197	1862	123	215	372	964

Table shows maximum wirefill based on 50% of duct internal cross sectional area. Formula = area/2.00 x D².

PANDUCT® Type H, HN and HS Wiring Duct – Wirefill Capacity

Nominal Duct Size (W x H) In.	Nominal Area In. ²	Electrical															Communication			
		8 AWG		10 AWG		12 AWG		14 AWG		16 AWG		18 AWG		22 AWG		23 AWG	23/24 AWG	24 AWG	Fiber Cable	
		.216	.164	.130	.141	.152	.111	.124	.133	.096	.111	.118	.084	.100	.106	.085	.330	.250	.190	.118
1.50 x 2.00	3.000	34	60	95	81	70	131	105	91	175	131	116	229	162	144	224	14	25	44	116
1.50 x 3.00	4.500	52	90	143	122	105	197	158	137	263	197	174	344	243	216	336	22	38	67	174
2.00 x 2.00	4.000	46	80	127	108	93	175	140	122	234	175	155	306	216	192	299	19	34	59	154
2.00 x 3.00	6.000	69	120	191	163	140	263	210	183	351	263	232	459	324	288	448	29	51	89	232
2.00 x 4.00	8.000	92	160	255	217	187	350	281	244	469	350	310	612	432	384	598	39	69	119	309
3.00 x 3.00	9.000	104	180	287	244	210	394	316	275	527	394	349	689	486	432	673	44	77	134	348
3.00 x 4.00	12.000	139	241	383	326	280	526	421	366	703	526	465	919	648	577	897	59	103	179	464
4.00 x 4.00	16.000	185	321	511	435	374	701	562	488	938	701	621	1225	864	769	1197	79	138	239	619

Table shows maximum wirefill based on 50% of duct internal cross sectional area. Formula = nominal area/1.85 x D². See page C1.48 for wiring duct color and size availability. AWG dimensions represent typical outer cable diameter in inches.

PANDUCT® Type D, G, F and FS Wiring Duct – Wirefill Capacity

Nominal Duct Size (W x H) In.	Nominal Area In. ²	Electrical															Communication					
		8 AWG		10 AWG		12 AWG			14 AWG			16 AWG			18 AWG			22 AWG	23 AWG	23/24 AWG	24 AWG	Fiber Cable
		.216	.164	.13	.141	.152	.111	.124	.133	.096	.111	.118	.084	.100	.106	.085	.330	.25	.190	.118		
		THHN	THHN	THHN	MTW	MTW	THHN	MTW	MTW	TFFN	MTW	MTW	TFFN	MTW	MTW	MTW	Cat. 6A	Cat. 6	Cat. 5e	3.0 mm		
0.50 x 0.50	0.250	3	5	8	7	6	11	9	8	15	11	10	20	14	12	19	1	2	3	10		
0.50 x 1.00	0.500	6	10	16	14	12	23	18	16	31	23	20	40	28	25	39	2	4	7	20		
0.50 x 2.00	1.000	12	21	33	28	24	46	37	32	62	46	41	80	57	50	79	5	9	15	40		
0.50 x 4.00	2.000	24	42	67	57	49	92	74	64	124	92	82	161	114	101	158	10	18	31	81		
0.75 x 0.75	0.563	6	11	19	16	13	26	20	18	34	26	23	45	32	28	44	2	5	8	23		
0.75 x 1.00	0.750	9	15	25	21	18	34	27	24	46	34	30	60	42	38	59	3	6	11	30		
0.75 x 1.50	1.125	13	23	38	32	27	52	41	36	69	52	46	91	64	57	88	5	10	17	46		
0.75 x 2.00	1.500	18	31	50	43	37	69	55	48	93	69	61	121	85	76	118	7	13	23	61		
1.00 x 1.00	1.000	12	21	33	28	24	46	37	32	62	46	41	80	57	50	79	5	9	15	40		
1.00 x 1.50	1.500	18	31	50	43	37	69	55	48	93	69	61	121	85	76	118	7	13	23	61		
1.00 x 2.00	2.000	24	42	67	57	49	92	74	64	124	92	82	161	114	101	158	10	18	31	81		
1.00 x 3.00	3.000	36	63	101	86	74	139	111	96	186	139	123	242	171	152	237	15	27	47	122		
1.00 x 4.00	4.000	48	84	135	114	98	185	148	129	248	185	164	323	228	203	316	20	36	63	163		
1.50 x 1.00	1.500	18	31	50	43	37	69	55	48	93	69	61	121	85	76	118	7	13	23	61		
1.50 x 1.50	2.250	27	47	76	64	55	104	83	72	139	104	92	182	128	114	177	11	20	35	92		
1.50 x 2.00	3.000	36	63	101	86	74	139	111	96	186	139	123	242	171	152	237	15	27	47	122		
1.50 x 3.00	4.500	55	95	152	129	111	208	167	145	279	208	184	364	257	228	355	23	41	71	184		
1.50 x 4.00	6.000	73	127	202	172	148	278	222	193	372	278	246	485	342	305	474	31	54	94	245		
2.00 x 1.00	2.000	24	42	67	57	49	92	74	64	124	92	82	161	114	101	158	10	18	31	81		
2.00 x 1.50	3.000	36	63	101	86	74	139	111	96	186	139	123	242	171	152	237	15	27	47	122		
2.00 x 2.00	4.000	48	84	135	114	98	185	148	129	248	185	164	323	228	203	316	20	36	63	163		
2.00 x 3.00	6.000	73	127	202	172	148	278	222	193	372	278	246	485	342	305	474	31	54	94	245		
2.00 x 4.00	8.000	97	169	270	229	197	371	297	258	496	371	328	647	457	406	632	41	73	126	327		
2.00 x 5.00	10.000	122	212	338	287	247	463	371	323	620	463	410	809	571	508	790	52	91	158	409		
2.50 x 3.00	7.500	91	159	253	215	185	347	278	242	465	347	307	607	428	381	593	39	68	118	307		
3.00 x 1.00	3.000	36	63	101	86	74	139	111	96	186	139	123	242	171	152	237	15	27	47	122		
3.00 x 2.00	6.000	73	127	202	172	148	278	222	193	372	278	246	485	342	305	474	31	54	94	245		
3.00 x 3.00	9.000	110	191	304	258	222	417	334	290	558	417	369	728	514	457	711	47	82	142	368		
3.00 x 4.00	12.000	146	254	405	344	296	556	445	387	744	556	492	971	685	610	949	62	109	189	491		
3.00 x 5.00	15.000	183	318	507	431	370	695	557	484	930	695	615	1214	857	762	1186	78	137	237	614		
4.00 x 1.50	6.000	73	127	202	172	148	278	222	193	372	278	246	485	342	305	474	31	54	94	245		
4.00 x 2.00	8.000	97	169	270	229	197	371	297	258	496	371	328	647	457	406	632	41	73	126	327		
4.00 x 3.00	12.000	146	254	405	344	296	556	445	387	744	556	492	971	685	610	949	62	109	189	491		
4.00 x 4.00	16.000	195	339	540	459	395	742	594	516	992	742	656	1295	914	813	1265	83	146	253	655		
4.00 x 5.00	20.000	244	424	676	574	494	927	743	646	1240	927	820	1619	1142	1017	1581	104	182	316	819		
6.00 x 4.00	24.000	293	509	811	689	593	1113	891	775	1488	1113	984	1943	1371	1220	1898	125	219	379	983		

Table shows maximum wirefill based on 50% of duct internal cross sectional area. Formula = nominal area/1.75 x D². See page C1.48 for wiring duct color and size availability. Not all sizes available for each duct type. AWG dimensions represent typical outer cable diameter in inches.

A. System Overview

B1. Cable Ties

B2. Cable Accessories

B3. Stainless Steel Ties

C1. Wiring Duct

C2. Surface Raceway

C3. Abrasion Protection

C4. Cable Management

D1. Terminals

D2. Power Connectors

D3. Grounding Connectors

E1. Labeling Systems

E2. Labels

E3. Pre-Printed & Write-On Markers

E4. Permanent Identification

E5. Lockout/Tagout & Safety Solutions

F. Index

A. System Overview

PANDUCT® Type MC, NNC and TMC Wiring Duct – Wirefill Capacity

Nominal Duct Size (W x H) mm	Nominal Area mm ²	Electrical															Communication						
		8 AWG		10 AWG			12 AWG			14 AWG			16 AWG			18 AWG			22 AWG	23 AWG	23/24 AWG	24 AWG	Fiber Cable
		5.5	4.2	3.3	3.6	3.9	2.8	3.1	3.4	2.4	2.8	3	2.1	2.5	2.7	2.2	8.4	6.4	4.8	3			
		THHN	THHN	THHN	MTW	MTW	THHN	MTW	MTW	TFFN	MTW	MTW	TFFN	MTW	MTW	MTW	Cat. 6A	Cat. 6	Cat. 5e	3.0 mm			
25 x 25	625	11	20	32	27	23	44	36	31	60	44	39	78	55	49	76	5	8	15	39			
25 x 37	925	17	30	48	41	35	66	53	46	88	66	58	116	81	72	113	7	13	22	58			
25 x 50	1250	23	41	65	55	47	89	72	62	120	89	79	156	110	98	153	10	17	30	79			
25 x 62	1550	29	51	81	69	59	111	89	77	148	111	98	194	137	122	190	12	21	38	98			
25 x 75	1875	35	61	98	83	71	134	108	93	180	134	119	235	166	147	229	15	26	46	119			
37 x 37	1369	25	45	71	60	52	98	78	68	131	98	87	171	121	107	167	11	19	33	86			
37 x 50	1850	35	60	96	82	70	132	106	92	177	132	117	232	163	145	226	15	26	45	117			
37 x 62	2294	43	75	120	102	87	164	132	114	220	164	145	287	203	180	281	18	32	56	145			
37 x 75	2775	52	91	145	123	106	199	159	138	266	199	176	348	245	218	340	22	39	68	176			
50 x 50	2500	47	82	131	111	95	179	144	125	240	179	159	313	221	197	306	20	35	61	158			
50 x 75	3750	71	123	196	167	143	269	216	187	360	269	238	470	332	295	459	30	53	92	238			
50 x 100	5000	94	164	262	222	191	359	288	250	480	359	318	627	442	394	612	40	70	122	317			
62 x 37	2294	43	75	120	102	87	164	132	114	220	164	145	287	203	180	281	18	32	56	145			
62 x 62	3844	72	126	201	171	147	276	221	192	369	276	244	482	340	303	471	31	54	94	244			
75 x 50	3750	71	123	196	167	143	269	216	187	360	269	238	470	332	295	459	30	53	92	238			
75 x 62	4650	88	153	243	207	178	334	267	232	446	334	295	583	411	366	570	37	65	114	295			
75 x 75	5625	106	185	294	250	215	404	324	281	540	404	357	706	498	443	689	45	79	138	357			
75 x 100	7500	142	246	393	334	287	539	432	375	720	539	477	941	664	591	919	60	106	184	476			
100 x 50	5000	94	164	262	222	191	359	288	250	480	359	318	627	442	394	612	40	70	122	317			
100 x 62	6200	117	204	324	276	237	445	357	310	595	445	394	778	549	488	760	50	87	152	393			
100 x 75	7500	142	246	393	334	287	539	432	375	720	539	477	941	664	591	919	60	106	184	476			
100 x 100	10000	189	329	524	445	383	718	576	500	961	718	636	1255	885	788	1225	81	141	245	634			

Table shows maximum wirefill based on 50% of duct internal cross sectional area. Formula = nominal area/1.75 x D². See page C1.48 for wiring duct color and size availability. Not all sizes available for each duct type. AWG dimensions represent typical outer cable diameter in millimeters.

D1. Terminals

D2. Power Connectors

D3. Grounding Connectors

E1. Labeling Systems

E2. Labels

E3. Pre-Printed & Write-On Markers

E4. Permanent Identification

E5. Lockout/Tagout & Safety Solutions

F. Index

PANDUCT® Type NE Wiring Duct – Wirefill Capacity

Nominal Duct Size (W x H) In.	Nominal Area In. ²	Electrical															Communication					
		8 AWG		10 AWG		12 AWG			14 AWG			16 AWG			18 AWG			22 AWG	23 AWG	23/24 AWG	24 AWG	Fiber Cable
		.216	.164	.130	.141	.152	.111	.124	.133	.096	.111	.118	.084	.100	.106	.085	.330	.25	.190	.118		
		THHN	THHN	THHN	MTW	MTW	THHN	MTW	MTW	TFFN	MTW	MTW	TFFN	MTW	MTW	MTW	Cat. 6A	Cat. 6	Cat. 5e	3.0 mm		
0.50 x 0.50	0.250	2	4	7	6	5	10	8	7	13	10	8	17	12	17	1	2	3	8			
0.50 x 1.00	0.500	5	9	14	12	10	20	16	14	27	20	17	35	25	22	34	2	4	6	17		
1.00 x 1.00	1.000	10	18	29	25	21	40	32	28	54	40	35	70	50	44	69	4	8	13	35		
1.00 x 1.50	1.500	16	27	44	37	32	60	48	42	81	60	53	106	75	66	103	6	12	20	53		
1.00 x 2.00	2.000	21	37	59	50	43	81	65	56	108	81	71	141	100	88	138	9	16	27	71		
1.00 x 3.00	3.000	32	55	88	75	64	121	97	84	162	121	107	212	150	133	207	13	24	41	107		
1.00 x 4.00	4.000	42	74	118	100	86	162	130	113	217	162	143	283	200	177	276	18	32	55	143		
1.50 x 1.50	2.250	24	41	66	56	48	91	73	63	122	91	80	159	112	100	155	10	18	31	80		
1.50 x 2.00	3.000	32	55	88	75	64	121	97	84	162	121	107	212	150	133	207	13	24	41	107		
1.50 x 3.00	4.500	48	83	133	113	97	182	146	127	244	182	161	318	225	200	311	20	36	62	161		
1.50 x 4.00	6.000	64	111	177	150	129	243	195	169	325	243	215	425	300	266	415	27	48	83	215		
2.00 x 1.00	2.000	21	37	59	50	43	81	65	56	108	81	71	141	100	88	138	9	16	27	71		
2.00 x 2.00	4.000	42	74	118	100	86	162	130	113	217	162	143	283	200	177	276	18	32	55	143		
2.00 x 3.00	6.000	64	111	177	150	129	243	195	169	325	243	215	425	300	266	415	27	48	83	215		
2.00 x 4.00	8.000	85	148	236	201	173	324	260	226	434	324	287	566	400	355	553	36	64	110	286		
3.00 x 1.00	3.000	32	55	88	75	64	121	97	84	162	121	107	212	150	133	205	13	24	41	107		
3.00 x 2.00	6.000	64	111	177	150	129	243	195	169	325	243	215	425	300	266	415	27	48	83	215		
3.00 x 3.00	9.000	96	167	266	226	194	365	292	254	488	365	323	637	450	400	622	41	72	124	322		
3.00 x 4.00	12.000	128	223	355	301	259	486	390	339	651	486	430	850	600	533	830	55	96	166	430		
3.00 x 5.00	15.000	160	278	443	377	324	608	487	423	813	608	538	1062	750	667	1038	68	120	207	537		
4.00 x 2.00	8.000	85	148	236	201	173	324	260	226	434	324	287	566	400	355	553	36	64	110	286		
4.00 x 3.00	12.000	128	223	355	301	259	486	390	339	651	486	430	850	600	533	830	55	96	166	430		
4.00 x 4.00	16.000	171	297	473	402	346	649	520	452	868	649	574	1133	800	711	1107	73	128	221	573		
4.00 x 5.00	20.000	214	371	591	502	432	811	650	565	1085	811	718	1417	1000	889	1384	91	160	277	716		

Table shows maximum wirefill based on 50% of duct internal cross sectional area. Formula = nominal area/2.00 x D². AWG dimensions represent typical outer cable diameter in inches.

PANDUCT® Type FL Wiring Duct – Wirefill Capacity

Nominal Duct Size (W x H) mm	Nominal Area mm ²	Electrical															Communication					
		8 AWG		10 AWG		12 AWG			14 AWG			16 AWG			18 AWG			22 AWG	23 AWG	23/24 AWG	24 AWG	Fiber Cable
		5.5	4.2	3.3	3.6	3.9	2.8	3.1	3.4	2.4	2.8	3.0	2.1	2.5	2.7	2.2	8.4	6.4	4.8	3.0		
		THHN	THHN	THHN	MTW	MTW	THHN	MTW	MTW	TFFN	MTW	MTW	TFFN	MTW	MTW	MTW	Cat. 6A	Cat. 6	Cat. 5e	3.0 mm		
12 x 12	144	1	3	5	4	3	7	5	5	9	7	6	12	8	7	12	0	1	2	6		
25 x 25	625	8	14	22	19	16	31	25	21	42	31	27	54	38	34	53	3	6	10	27		
50 x 50	2500	33	57	91	77	67	125	100	87	168	125	111	219	155	137	214	14	24	42	111		

Table shows maximum wirefill based on 50% of duct internal cross sectional area. Formula = nominal area/2.50 x D². AWG dimensions represent typical outer cable diameter in millimeters.

A. System Overview

B1. Cable Ties

B2. Cable Accessories

B3. Stainless Steel Ties

C1. Wiring Duct

C2. Surface Raceway

C3. Abrasion Protection

C4. Cable Management

D1. Terminals

D2. Power Connectors

D3. Grounding Connectors

E1. Labeling Systems

E2. Labels

E3. Pre-Printed & Write-On Markers

E4. Permanent Identification

E5. Lockout/Tagout & Safety Solutions

F. Index

A.
System
Overview

Wirefill Formula

B1.
Cable Ties

General Formula

PANDUIT Wiring Duct wirefills are calculated using the following general formula:

$$50\% \text{ Wirefill} = 50\% \text{ of } \left(\frac{\text{Usable Duct Area}}{\text{Wire Area}} \right)$$

B2.
Cable
Accessories

B3.
Stainless
Steel Ties

Why use a 50% Wirefill?

As specified in NFPA79-2007 section 13.5.2, *Percentage Fills of Raceways (Ducts)*, a 50% wirefill is given as the maximum wirefill capacity in all PANDUIT Wiring Ducts. This helps ensure general safe wiring practices are followed. In actual practice, a 50% wirefill is the maximum amount of wiring the duct can hold given the additional airspace created between cables by non-uniform cable shapes, cable interlacing, and cable packing factors.

C1.
Wiring
Duct

C2.
Surface
Raceway

What is the Usable Duct Area?

The usable area we define as the calculation of internal area that can be occupied by wires or cables.

Calculation of Internal Area

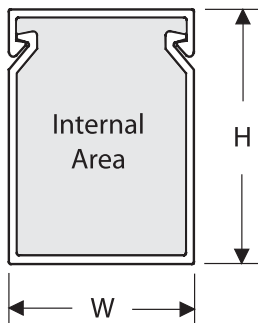

Since we use the outer channel dimensions in our calculation we make an adjustment in our formula for the thickness of material and for design elements that extend inside the channel.

Air Space Allotment

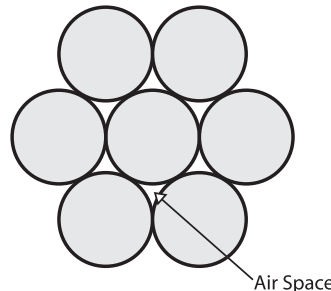

In our wirefill formula an adjustment is made to the channel internal area to account for "unused" air space that will be present between cables when placed in the channel. Our formula assumes a uniform close packed or high-density cable arrangement (see diagram) (Note 1).

D1.
Terminals

Considering these factors the usable duct area is equal to an average of 90% of the nominal area, or $(W \times H) \times .90$.

D2.
Power
Connectors

D3.
Grounding
Connectors

Wire Area

The wire area formula is converted to allow calculation using the cable diameter:

$$\begin{aligned} A_{\text{WIRE}} &= \pi r^2 \\ A_{\text{WIRE}} &= (\pi/4) \times D^2 \\ A_{\text{WIRE}} &= .785 \times D^2 \end{aligned}$$

E1.
Labeling
Systems

E2.
Labels

Formula Derivation

Inserting the elements from above into the general formula results in the following:

$$50\% \text{ Wirefill} = .50 \left(\frac{(W \times H) \times .90}{.785 \times D^2} \right)$$

Simplifying this formula results in the formula used for wirefill calculation (Note 2):

$$50\% \text{ Wirefill} = \left(\frac{W \times H}{1.75 \times D^2} \right)$$

E3.
Pre-Printed
& Write-On
Markers

E4.
Permanent
Identification

Note: When calculating wirefill capacity using the above formula, variables W, H and D must be expressed in same units (i.e. mm or inches).

E5.
Lockout/
Tagout
& Safety
Solutions

F.
Index

¹ This calculation does not account for additional airspace created between cables by non-uniform cable shapes, cable interlacing, and cable packing factors.
² The resulting formula is used for all PANDUIT flush cover ducts, this excludes type NE duct which has a different profile design that results in a divisor of $2.0 \times D^2$ (rather than $1.75 \times D^2$ as shown here) and type H and HS wiring duct with a profile design that results in a divisor of $1.85 \times D^2$ and corner wiring duct which uses calculated internal area and a divisor of $2.0 \times D^2$.

PANDUCT® Wiring Duct and Raceway – Material Specifications

Properties	Units	Test Method	Lead-Free PVC	Halogen-Free Modified PPO (NNC)	NORYL* (NE)	Polypropylene (FL)	Low Smoke/ Low Toxicity (TMC)
General							
Specific gravity	g/cc	ASTM D 792	1.45	1.09	1.08	.95	1.56
Heat deflection temperature @264 psi	°F	ASTM D 648	156	215	212	117	222
Thermal expansion	10 – 5 in./in./°F	ASTM D 696	3.7	3.8	3.8	N/A	3.8
Thermal conductivity	(BTU-in./hr-ft. ²)°F	ASTM C 177	1.3	1.3	1.1	N/A	N/A
Burning Characteristics							
Flammability class	—	UL 94	V-0	V-0	V-1	V-2	V-0
Smoke density @ 4 minutes	—	ASTM E 662	538	513	782	N/A	92
Limited oxygen index (LOI)	—	ASTM D 2863	35	30	30	25	58
Peak heat release rate	kW/m2	ASTM E 1354	N/A	N/A	N/A	N/A	49.3
Hardness							
Durometer hardness	“D”	ASTM D 2240	78	N/A	85	N/A	N/A
Rockwell hardness	“R”	ASTM D 785	111	116	115	N/A	118
Tensile							
Yield strength	psi	ASTM D 638	6,200	7,700	6,900	3,770	6,600
Modulus	psi	ASTM D 638	390,000	350,000	380,000	172,000	316,000
Flexural							
Yield strength	psi	ASTM D 790	8,700	11,500	11,400	4,350	11,900
Modulus	psi	ASTM D 790	325,000	340,000	365,000	181,250	317,000
Impact strength							
Notched Izod (.125”)		ASTM D 256					
23°C (73°F)	ft.-lb./in.		4.0	5.0	5.0	1.8	3.0
0°C (32°F)	ft.-lb./in.		1.6	2.0	N/A	N/A	N/A
Electrical Properties							
Power factor:		ASTM D 150					
60 Hz @30°C (86°F)	—		2.90	N/A	N/A	N/A	N/A
1 MHz @30°C (86°F)	—		4.00	N/A	N/A	N/A	N/A
Dielectric constant:		ASTM D 150					
60 Hz @30°C (86°F)	—		3.90	N/A	2.65	N/A	N/A
1 MHz @30°C (86°F)	—		3.30	N/A	N/A	N/A	N/A
Dielectric strength:		ASTM D 149					
Unconditioned	volts/mil		690	N/A	400	N/A	N/A
Conditioned	volts/mil		700	N/A	N/A	N/A	N/A

Note: To the best of our knowledge the above information is accurate.
 PANDUIT assumes no liability for the accuracy or completeness of this information.

Rigid Polyvinyl Chloride (PVC)

A general purpose material for use in indoor applications. PVC has a UL flammability rating of V-0 and is UL 94 Recognized for continuous use temperatures up to 122°F (50°C). PVC is an economical wiring duct material.

Halogen-Free (Modified PPO)

A special purpose material for use in halogen-free or high temperature applications. Modified PPO has a UL 94 flammability rating of V-0 and is UL Recognized for continuous use temperatures up to 203°F (95°C), and is 20% lighter than PVC.

NORYL* Halogen-Free

A special purpose material for use in halogen-free or high temperature applications. NORYL* has a UL 94 flammability rating of V-1 and is UL Recognized for continuous use temperatures up to 203°F (95°C), and is 20% lighter than PVC.

Polypropylene

A flexible material with a UL 94 flammability rating of V-2 and that is UL Recognized for continuous use temperatures up to 149°F (65°C).

Low Smoke/ Low Toxicity

A special purpose material for use where low smoke, low toxicity and low flammability characteristics are critical. Ideally suited for transportation industry regulations. Low smoke/ low toxicity has a UL 94 flammability rating of V-0 and is UL Recognized for continuous use temperatures up to 176°F (80°C).

*NORYL is a registered trademark of General Electric Company.

A. System Overview

B1. Cable Ties

B2. Cable Accessories

B3. Stainless Steel Ties

C1. Wiring Duct

C2. Surface Raceway

C3. Abrasion Protection

C4. Cable Management

D1. Terminals

D2. Power Connectors

D3. Grounding Connectors

E1. Labeling Systems

E2. Labels

E3. Pre-Printed & Write-On Markers

E4. Permanent Identification

E5. Lockout/ Tagout & Safety Solutions

F. Index

A. System Overview **PANDUCT® Wiring Duct and Raceway – Color and Size Selection**

B1. Cable Ties

B2. Cable Accessories

B3. Stainless Steel Ties

C1. Wiring Duct

C2. Surface Raceway

C3. Abrasion Protection

C4. Cable Management

D1. Terminals

D2. Power Connectors

D3. Grounding Connectors

E1. Labeling Systems

E2. Labels

E3. Pre-Printed & Write-On Markers

E4. Permanent Identification

E5. Lockout/Tagout & Safety Solutions

F. Index

Duct Size W x H	LG Light Gray								WH White								BL Black				IB Intrinsic Blue*		BR Beige		IG Int'l. Gray											
	In.	mm	G	F	FS					FL	G	F	FS		NE																					
.5 x .5	12 x 12																																			
.5 x 1																																				
.5 x 2																																				
.5 x 4																																				
.75 x .75																																				
.75 x 1																																				
.75 x 1.5																																				
.75 x 2																																				
1 x 1	25 x 25																																			
1 x 1.5	25 x 37																																			
1 x 2	25 x 50																																			
1 x 2.5	25 x 62																																			
1 x 3	25 x 75																																			
1 x 4	25 x 100																																			
1.5 x 1																																				
1.5 x 1.5	37 x 37																																			
1.5 x 2	37 x 50																																			
1.5 x 2.5	37 x 62																																			
1.5 x 3	37 x 75																																			
1.5 x 4																																				
2 x 1																																				
2 x 1.5																																				
2 x 2	50 x 50																																			
2 x 3	50 x 75																																			
2 x 4	50 x 100																																			
2 x 5																																				
2.5 x 1.5	62 x 37																																			
2.5 x 2.5	62 x 62																																			
2.5 x 3																																				
3 x 1																																				
3 x 2	75 x 50																																			
3 x 2.5	75 x 62																																			
3 x 3	75 x 75																																			
3 x 4	75 x 100																																			
3 x 5																																				
4 x 1.5																																				
4 x 2	100 x 50																																			
4 x 2.5	100 x 62																																			
4 x 3	100 x 75																																			
4 x 4	100 x 100																																			
4 x 5																																				
6 x 4																																				

*Intrinsic Blue Color – IB

Intrinsic blue wiring duct is made from the same lead-free PVC material as our standard PVC duct. Intrinsic blue is an internationally recognized standard blue color that identifies the wiring duct as “incapable of releasing sufficient electrical or thermal energy under normal or abnormal conditions to cause ignition of a specific hazardous atmospheric mixture in its most easily ignited concentrations.”

*ISA-RD12.6 (Instrument Society of America)

Installation Tips:

Application of Latex Paint on PANDUCT® Wiring Duct



The following is recommended to properly prepare the surface of the wiring duct/raceway and covers for the best adhesion of latex paint:

1. Clean surface with mild soap and water solution or mineral spirits with a clean lint free towel. Allow to dry.
2. Using a sanding pad (such as synthetic stripping pad or medium/fine steel wool), slightly roughen the surface to be painted.
3. Apply a coat of all-purpose 100% acrylic primer and allow to dry.
4. Apply the desired topcoat of latex paint and allow to dry.
5. Install the wiring duct/raceway and covers.

Cutting Wiring Duct and Cover

For small quantities, use the DCT duct cutting tool on page C1.34. For larger quantities use a miter cutting saw blade for clean burr-free cuts. Recommended blade: *Carbide 80T or 100T; .90" thickness, .125 kerf.*

Recommended Precaution when Using Type NNC and NE Wiring Duct

Cleaning solvents and cutting fluids that contain any of the following chemical agents should not come in contact with type NNC or type NE wiring duct. These chemicals are known to cause stress cracking in the halogen-free PPO material.

- Hydrocarbons
- Phenols
- Ketones
- Amines
- Ethers
- Organic, inorganic and oxidizing acids
- Petrol

Note: PANDUIT assumes no liability for the accuracy or completeness of this list.

Part Number System for Wiring Duct

G		.5	X	.5	LG	6	-A
Type		Nominal Width		Nominal Height	Color	Length	
		In. or mm		In. or mm		Ft. or m	
G = Wide Slot Flush Design					LG = Light Gray		-A = Adhesive Backed = Without Adhesive (leave blank)
F = Narrow Slot Flush Design					WH = White		NM = No Mounting Holes
FL = Flexible Duct					BL = Black		
FS = Solid Wall Flush Design					IB = Intrinsic Blue		
H = Wide Slot Hinged Design					BR = Beige		
HN = Narrow Slot Hinged Design					IG = International Gray		
HS = Solid Wall Hinged Design							
D = Round Hole Flush Design							
NNC = Halogen-Free Design							
NE = NORYL* Wide Slot Design							
MC = Metric Narrow Slot Design							
TMC = Low Smoke Metric Design							
CWD = Corner Wiring Duct							





*NORYL is a registered trademark of General Electric Company.

PANDUIT Wiring Duct Approvals and Compliances



Logo (Symbol)	Agency	Spec/Approval	Requirement	Applicable Products
	Underwriters Laboratories, Inc.	File No. E147128	UL Standard 1565 "Positioning Devices." CSA Standard C22.2 No.18.5-02 "Positioning Devices."	Wiring duct types: H, HS, and HN
	Underwriters Laboratories, Inc.	File No. E147128	UL Standard 1565 "Positioning Devices."	All types of wiring duct
	Canadian Standards Association	File No. 016446, 210335	CSA Standard C22.2 No.18.5-02 "Positioning Devices."	All types of wiring duct
	Conformite European	2006/95/EEC	ENC50085 cable trunking system and cable ducting systems for electrical installations <ul style="list-style-type: none"> • CDS (cable ducting system) for impact 2 J • Minimum storage and transport temperature -5°C • Minimum installation and application temperature -5°C • Maximum application temperature 60°C • Non-flame propagating • Without electrical continuity • Cover removable without a tool 	Wiring duct types: H, HS, G, F, D, MC, FS, NNC, TMC and NE
Logo (Symbol)	Agency	Complies with:	Requirement	Applicable Products
	DIN (Deutsches Institut für Normung), German Institute for Standardization	DIN 43 659	This European standard specifies dimensions for slotted trunkings that will be used in electrical switchgear assemblies and that conform to the corresponding requirements in DIN VDE 060 Part 506. The dimensions specified with the standard include: <ul style="list-style-type: none"> • The channel mounting hole pattern, slot dimensions, pitch and location • The distance from the first to last like size mounting hole • Minimum overall product length 	Wiring duct types: MC, TMC and NNC
	National Fire Protection Agency	NFPA 79-2007, section 13.3.1	"Nonmetallic ducts shall be permitted (inside enclosures) only when they are made with a flame retardant material." Flame-retardant material is defined in the standard by the IEC 60332-1 test method.	Wiring duct types: H, G, F, D, MC, NNC, TMC and CWD
		NFPA 79-2007, section 13.5.2	PANDUIT wiring duct publishes a maximum percentage wirefill for common wire types equal to 50% of the interior cross-sectional area of the duct.	Wiring duct types: H, G, F, FS, D, MC, NNC and TMC
		NFPA 79-2007, section 13.1.5.9	PANDUIT bend radius control accessories can be mounted at right angle and tee junctions created using wiring duct in order to maintain cable bend radius control.	Duct corner strip with 1" bend radius control
		NFPA 130, 2007 edition, section 8.4.1	Performance criteria for the Flammability and Smoke Emission Characteristics of Materials used in Fixed Guideway Vehicles and Passenger Rail Cars.	Type TMC wiring duct

PANDUIT Wiring Duct Approvals and Compliances (continued)

Logo (Symbol)	Agency	Spec/Approval	Requirement	Applicable Products
	Underwriters Laboratories, Inc.	UL 508, section 15	An insulating barrier (divider wall) shall be manufactured from an insulating material exhibiting minimum properties including High Current Arc Resistance to ignition (HAI), Hot Wire Ignition (HWI), Comparative Tracking Index (CTI), electrical Relative Thermal Index (RTI) and flame class.	PVC divider wall
	Elevated temperature	PANDUIT logo	Material is rated for a continuous use temperature above 167°F (75°C).	Wiring duct types: NE, NNC, and NNC
	Halogen-free IEC 60754-2	PANDUIT logo	Material contains no fluorine, bromide, or chlorine and will not emit any corrosive or toxic gases when burned, confirmed using IEC 60754-2 test method.	Wiring duct types: NE and NNC
	Low flammability UL 94V-0	PANDUIT logo	Per UL standard, material is self-extinguishing and has excellent fire resistance.	Wiring duct types: NNC, TMC, and all PVC wiring duct
	Low smoke ASTM E 662	PANDUIT logo	Per ASTM test method and NFPA 130 standard, material exceeds the requirements for low smoke generating material.	Wiring duct type: TMC
	Low toxicity Boeing and Airbus BSS-7239, ATS 1000.1	PANDUIT logo	Per the Boeing and Airbus test standards, material exceeds the requirements for low levels of toxic gas release.	Wiring duct types: NNC and TMC

A.
System
Overview

B1.
Cable Ties

B2.
Cable
Accessories

B3.
Stainless
Steel Ties

C1.
Wiring
Duct

C2.
Surface
Raceway

C3.
Abrasion
Protection

C4.
Cable
Management

D1.
Terminals

D2.
Power
Connectors

D3.
Grounding
Connectors

E1.
Labeling
Systems

E2.
Labels

E3.
Pre-Printed
& Write-On
Markers

E4.
Permanent
Identification

E5.
Lockout/
Tagout/
& Safety
Solutions

F.
Index

A.
System
Overview

B1.
Cable Ties

B2.
Cable
Accessories

B3.
Stainless
Steel Ties

C1.
Wiring
Duct

C2.
Surface
Raceway

C3.
Abrasion
Protection

C4.
Cable
Management

D1.
Terminals

D2.
Power
Connectors

D3.
Grounding
Connectors

E1.
Labeling
Systems

E2.
Labels

E3.
Pre-Printed
& Write-On
Markers

E4.
Permanent
Identification

E5.
Lockout/
Tagout/
& Safety
Solutions

F.
Index

NOTES

FIBER-DUCT™ ROUTING SYSTEM

PANDUIT provides leading solutions for cable routing. These routing products are compatible with our cable management solutions increasing your ability to maintain an orderly and clean work environment, implement quick and easy moves, adds, and changes and maintain the integrity of your fiber and copper cabling plant in order to maximize long-term performance.



- Two system sizes available: 2x2 and 4x4
- Minimum 2 inch (50.8mm) bend radius fittings protect against signal loss due to excessive cable bends
- Snap-on non-slip covers
- Compatible with PANDUIT® FIBERRUNNER® 12x4, 6x4, 4x4 and 2x2 Routing Systems

The 2x2 and 4x4 FIBER-DUCT™ Routing Systems are comprised of channel, fittings, and brackets designed to segregate, route, and protect fiber optic and copper cabling to and between racks within the telecommunications room.

A.
System
Overview

B1.
Cable Ties

B2.
Cable
Accessories

B3.
Stainless
Steel Ties

C1.
Wiring
Duct

C2.
Surface
Raceway

C3.
Abrasion
Protection

C4.
Cable
Management

D1.
Terminals

D2.
Power
Connectors

D3.
Grounding
Connectors

E1.
Labeling
Systems

E2.
Labels

E3.
Pre-Printed
& Write-On
Markers

E4.
Permanent
Identification

E5.
Lockout/
Tagout
& Safety
Solutions

F.
Index

A. System Overview

2x2 and 4x4 FIBER-DUCT™ Routing Systems Roadmap

B1. Cable Ties

B2. Cable Accessories

B3. Stainless Steel Ties

C1. Wiring Duct

C2. Surface Raceway

C3. Abrasion Protection

C4. Cable Management

D1. Terminals

D2. Power Connectors

D3. Grounding Connectors

E1. Labeling Systems

E2. Labels

E3. Pre-Printed & Write-On Markers

E4. Permanent Identification

E5. Lockout/Tagout & Safety Solutions

F. Index

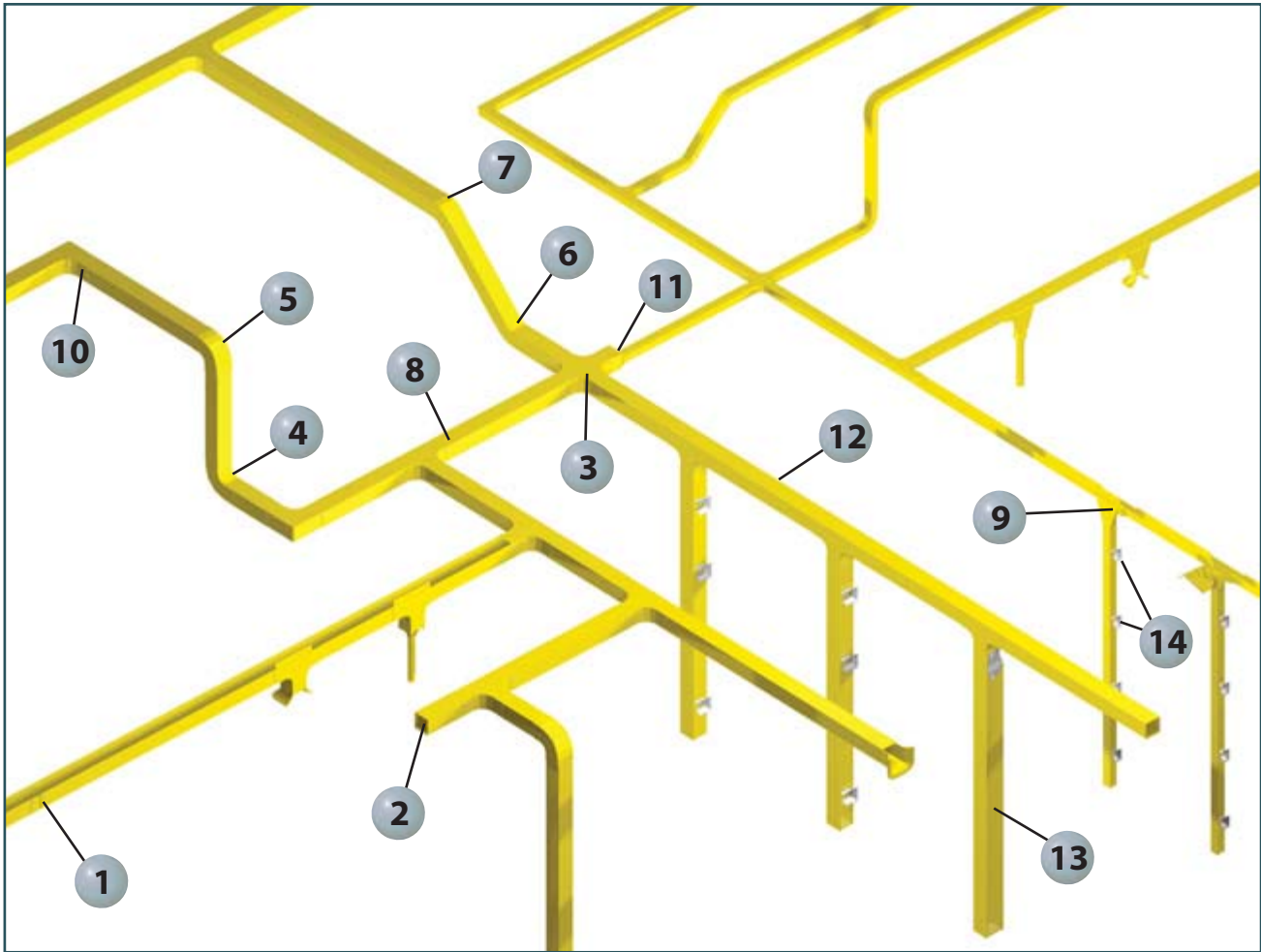

FIBER-DUCT™ Mounting Brackets

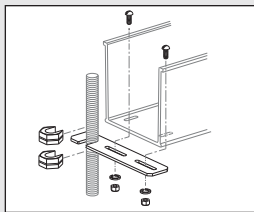

FTRBE12 – Existing Threaded Rod Bracket
(page C1.60)

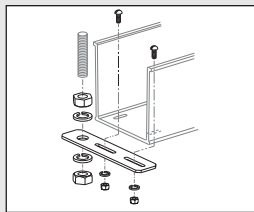

FTRBN12 – New Threaded Rod Bracket
(page C1.60)

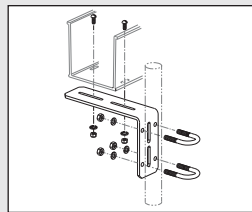

FUSB – Underfloor Pedestal Bracket
(page C1.60)

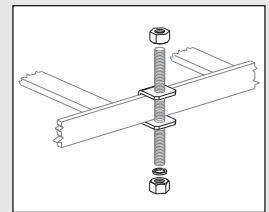

FLB12X15 – Bracket for Attaching Threaded Rod to Ladder Rack
(page C1.60)

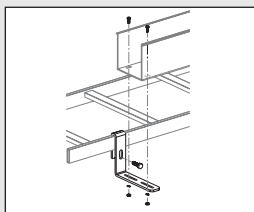

FLRB – Ladder Rack Bracket
(page C1.60)

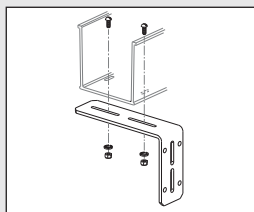

FLB – "L" Wall Mount Bracket
(page C1.60)

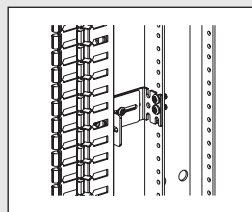

FZBA1.5X4 – Adjustable "Z" Bracket
(page C1.60)

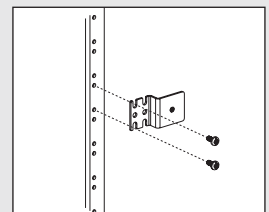

FZBLP – Low Profile "Z" Bracket
(page C1.60)

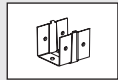

1 FCF2X2** and FCF4X4** – Coupler Fitting (see page C1.56)

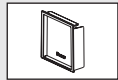

2 FEC2X2** and FEC4X4** – End Cap Fitting (see page C1.57)

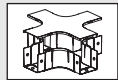

3 FFWC2X2** and FFWC4X4** – 4-Way Cross Fitting (see page C1.57)

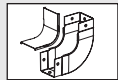

4 FIVRA2X2** and FIVRA4X4** – Inside Vertical Right Angle (see page C1.57)

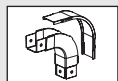

5 FOVRA2X2** and FOVRA4X4** – Outside Vertical Right Angle (see page C1.57)



6 FIV452X2** and FIV454X4** – Inside Vertical 45° Angle (see page C1.57)

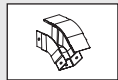

7 FOV452X2** and FOV454X4** – Outside Vertical 45° Angle (see page C1.57)

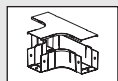

8 FT2X2** and FT4X4** – Horizontal Tee Fitting (see page C1.57)

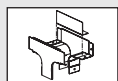

9 FVT4X4** – 4x4 Vertical Tee (see page C1.58)

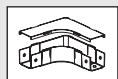

10 FRA2X2** – FRA4X4** – Right Angle Fitting (see page C1.56)

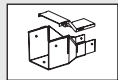

11 FRF42** – 4x4 to 2x2 FIBER-DUCT™ Reducer Fitting (see page C1.57)



12 S2X2**6NM and S4X4**6NM FIBER-DUCT™ Channel (see page C1.56)



13 E2X2**6 and E4X4**6 FIBER-DUCT™ Slotted Channel (see page C1.56)

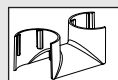

14 TRC2BL and TRC4BL – Bend Radius Control Trumpet (see page C1.59)

**Available colors include: YL (Yellow), OR (Orange), and BL (Black).

A.
System
Overview

B1.
Cable Ties

B2.
Cable
Accessories

B3.
Stainless
Steel Ties

C1.
Wiring
Duct

C2.
Surface
Raceway

C3.
Abrasion
Protection

C4.
Cable
Management

D1.
Terminals

D2.
Power
Connectors

D3.
Grounding
Connectors

E1.
Labeling
Systems

E2.
Labels

E3.
Pre-Printed
& Write-On
Markers

E4.
Permanent
Identification

E5.
Lockout/
Tagout
& Safety
Solutions

F.
Index

A. System Overview



2x2 and 4x4 FIBER-DUCT™ Routing Systems

B1. Cable Ties

- Channel, covers, fittings and other non-metallic system components made from V-0 flame class rated material
- Snap-on non-slip covers
- Compatible with PANDUIT® FIBERRUNNER® 2x2, 4x4, 6x4 and 12x4 Routing Systems

B2. Cable Accessories



S2X2
S4X4

B3. Stainless Steel Ties

C1. Wiring Duct



E2X2
E4X4

C2. Surface Raceway

C3. Abrasion Protection

C4. Cable Management



C2
C4

D1. Terminals

D2. Power Connectors

D3. Grounding Connectors

E1. Labeling Systems

E2. Labels

E3. Pre-Printed & Write-On Markers

E4. Permanent Identification

E5. Lockout/Tagout & Safety Solutions

F. Index

Part Number	Part Description	System Size	Std. Pkg. Qty.	Std. Ctn. Qty.
FIBER-DUCT™ Channel				
S2X2YL6NM	Used to carry the cables throughout the FIBER-DUCT™ Routing System. Accepts cover C2YL6. Cover sold separately.	2x2	6	120
S4X4YL6NM	Used to carry the cables throughout the FIBER-DUCT™ Routing System. Accepts cover C4YL6. Cover sold separately.	4x4	6	60

Part Number	Part Description	System Size	Std. Pkg. Qty.	Std. Ctn. Qty.
FIBER-DUCT™ Slotted Channel				
E2X2YL6	Used to carry the cables vertically to the front or the back of equipment racks throughout the system. Accepts cover C2YL6. Extra supports required when used in horizontal applications. Cover sold separately.	2x2	6	120
E4X4YL6	Used to carry the cables vertically to the front or the back of equipment racks throughout the system. Accepts cover C4YL6. Extra supports required when used in horizontal applications. Cover sold separately.	4x4	6	60

Part Number	Part Description	System Size	Std. Pkg. Qty.	Std. Ctn. Qty.
FIBER-DUCT™ Cover				
C2YL6	Cover for FIBER-DUCT™ Channel and FIBER-DUCT™ Slotted Channel. Non-slip cover design incorporates integral high friction lining to inhibit cover movement.	2x2	6	120
C4YL6	Cover for FIBER-DUCT™ Channel and FIBER-DUCT™ Slotted Channel. Non-slip cover design incorporates integral high friction lining to inhibit cover movement.	4x4	6	120

Note: Available with mounting holes. To order, delete NM from the part number. For fastest installation use NR2WH-L or NR4BL-L snap rivets. For other colors replace YL (Yellow) with OR (Orange) or BL (Black). Order number of feet required, in multiples of standard 6' length increments.

FIBER-DUCT™ System Fittings



FCF2X2
FCF4X4

FRA2X2
FRA4X4

Part Number	Part Description	System Size	Std. Pkg. Qty.	Std. Ctn. Qty.
Coupler Fitting				
FCF2X2YL	Used to join two sections of duct together. FIBER-DUCT™ Coupler is not required at each fitting connection.	2x2	1	5
FCF4X4YL		4x4	1	5
Horizontal Right Angle Fitting				
FRA2X2YL	Attaches to channel to create a 90° horizontal turn from a straight horizontal run. Cover included.	2x2	1	5
FRA4X4YL		4x4	1	5

For other colors replace suffix YL (Yellow) with OR (Orange) or BL (Black). Fittings include 5/16" assembly holes for fast mechanical fastening.

FIBER-DUCT™ System Fittings (continued)



FT2X2
FT4X4



FFWC2X2
FFWC4X4



FEC2X2
FEC4X4



FIV452X2
FIV454X4



FOV452X2
FOV454X4



FIVRA2X2
FIVRA4X4



FOVRA2X2
FOVRA4X4



FRF42

Part Number	Part Description	System Size	Std. Pkg. Qty.	Std. Ctn. Qty.
Horizontal Tee Fitting				
FT2X2YL	Attaches to channel to create a 90° horizontal branch from a straight horizontal run. Cover included.	2x2	1	5
FT4X4YL		4x4	1	5
4-Way Cross Fitting				
FFWC2X2YL	Attaches to channel to create a horizontal four way cross intersection. Cover included.	2x2	1	5
FFWC4X4YL		4x4	1	5
End Cap Fitting				
FEC2X2YL	Used for closing off open ends of the channel. No coupler required. Push-on installation.	2x2	1	5
FEC4X4YL		4x4	1	5
Inside Vertical 45° Angle Fitting				
FIV452X2YL	Attaches to channel to create a 45° upward angle from a straight horizontal run. Used with outside vertical 45° angle fitting FOV452X2YL or FOV454X4YL to change level of straight horizontal runs. Cover included.	2x2	1	5
FIV454X4YL		4x4	1	5
Outside Vertical 45° Angle Fitting				
FOV452X2YL	Attaches to channel to create a 45° downward angle from a straight horizontal run. Used with inside vertical 45° angle fitting FIV452X2YL or FIV454X4YL to change level of straight horizontal runs. Cover included.	2x2	1	5
FOV454X4YL		4x4	1	5
Inside Vertical Right Angle Fitting				
FIVRA2X2YL	Attaches to channel to create a 90° upward angle from a straight horizontal run. Used with outside vertical 90° angle fitting FOVRA2X2YL or FOVRA4X4YL to change level of straight horizontal runs. Cover included.	2x2	1	5
FIVRA4X4YL		4x4	1	5
Outside Vertical Right Angle Fitting				
FOVRA2X2YL	Attaches to channel to create a 90° downward angle from a straight horizontal run. Used with inside vertical 90° angle fitting FIVRA2X2YL or FIVRA4X4YL to change level of straight horizontal runs. Cover included.	2x2	1	5
FOVRA4X4YL		4x4	1	5
4x4 to 2x2 FIBER-DUCT™ Reducer Fitting				
FRF42YL	Joins any 4x4 FIBER-DUCT™ Fitting to the 2x2 FIBER-DUCT™ Channel, S2X2YL6 or E2X2YL6. Includes cover.	2x2 4x4	1	5

For other colors replace suffix YL (Yellow) with OR (Orange) or BL (Black).
Fittings include 5/16" assembly holes for fast mechanical fastening.

A.
System
Overview

B1.
Cable Ties

B2.
Cable
Accessories

B3.
Stainless
Steel Ties

C1.
Wiring
Duct

C2.
Surface
Raceway

C3.
Abrasion
Protection

C4.
Cable
Management

D1.
Terminals

D2.
Power
Connectors

D3.
Grounding
Connectors

E1.
Labeling
Systems

E2.
Labels

E3.
Pre-Printed
& Write-On
Markers

E4.
Permanent
Identification

E5.
Lockout/
Tagout
& Safety
Solutions

F.
Index

A. System Overview

FIBER-DUCT™ Spillouts

B1. Cable Ties



FVTHD2X2

B2. Cable Accessories



FTR2X2

B3. Stainless Steel Ties



FIDT2X2

C1. Wiring Duct

C2. Surface Raceway



FVT4X4

C3. Abrasion Protection

C4. Cable Management



FTR4X4

D1. Terminals

D2. Power Connectors



FIDT4X4BL

D3. Grounding Connectors

E1. Labeling Systems

E2. Labels

E3. Pre-Printed & Write-On Markers

E4. Permanent Identification

E5. Lockout/Tagout & Safety Solutions

F. Index

Part Number	Part Description	System Size	Std. Pkg. Qty.	Std. Ctn. Qty.
2x2 Vertical Tee				
FVTHD2X2YL	Attaches to 2x2 channel to create a 90° vertical drop from a horizontal run. Hinged door included. Accepts channel cover in conjunction with channel. Use <i>QUIKLOCK™</i> Coupler FBC2X2YL with HS2X2YL6 or H2X2YL6 channels. Use snap rivets NR2WH-L or bolts F14PN-L with S2X2YL6 or E2X2YL6 channels. Also accepts FIDT2X2YL.	2x2	1	5
3-Sided BRC Trumpet Spillout for 2x2 Exit				
FTR2X2YL	Used to limit the bend radius of the cable to 2" (50.8mm) when exiting from a <i>FIBERRUNNER®</i> Spill-Over FRSPYL or from 2x2 <i>FIBER-DUCT™</i> Channel.	2x2	1	5
1-Port Spillout to 1.5" (38mm) Inside Diameter Corrugated Tubing				
FIDT2X2YL	Used to route cable into one piece of 1.5" (38mm) diameter split corrugated tubing. Used with <i>FIBERRUNNER®</i> Spill-Over FRSPYL, 2x2 <i>FIBER-DUCT™</i> Fittings, and the 2x2 <i>FIBERRUNNER®</i> Hinged Channel. Securely holds split corrugated tubing to ensure system integrity and easy access to add or remove cables.	2x2	1	5
4x4 Vertical Tee				
FVT4X4YL	Attaches to channel to create a 90° vertical drop from a horizontal run. Accepts FIDT4X4BL, FTR4X4YL, S4X4YL6 or E4X4YL6 directly.	4x4	1	5
3-Sided Vertical Tee Trumpet Spillout				
FTR4X4YL	Used to limit the bend radius of the cable to 2" (50.8mm) when exiting from a 4x4 or 6x4 <i>FIBERRUNNER®</i> Vertical Tee and 4x4 <i>FIBER-DUCT™</i> Fittings.	4x4	1	5
2-Port Spillout to 1.5" (38mm) Inside Diameter Corrugated Tubing				
FIDT4X4BL	Used to route cable into one or two pieces of 1.5" (38mm) diameter split corrugated tubing. Used with FRVT6X4YL, FRVT4X4YL, or FVT4X4YL. Securely holds corrugated split tubing to ensure system integrity and easy access to add or remove cables. Black color only.	4x4	1	5

For other colors replace suffix YL (Yellow) with OR (Orange) or BL (Black).

FIBER-DUCT™ Bend Radius Control Trumpets

- Provide method to transition cabling into rack system
- Maintain 1 inch (25.4mm) bend radius control



TRC2BL



TRC4BL

Part Number	Part Description	System Size	Std. Pkg. Qty.	Std. Ctn. Qty.
TRC2BL	Bend radius control trumpet for exiting at the sidewall of 2" wall heights of type E FIBER-DUCT™ Channels.	2x2	1	10
TRC4BL	Bend radius control trumpet for exiting at the sidewall of 4" wall heights of type E FIBER-DUCT™ Channels.	4x4	1	10

FIBER-DUCT™ Accessories

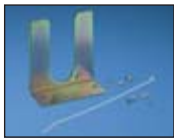

FITF4X4B



NR2WH-L
NR4BL-L



F14PWN-L



F14PN-L

Part Number	Part Description	System Size	Std. Pkg. Qty.	Std. Ctn. Qty.
Inner Duct Transition Fitting – 4x4 Size				
FITF4X4B	Provides transition from 4x4 FIBER-DUCT™ Routing System to two pieces of 1 1/4" (31.8mm) inner duct.	4x4	1	10
Snap Rivets				
NR2WH-L	Snap rivet fastens channel and fittings together for added strength and rigidity. Snap rivet mounts flush to surfaces.	2x2	50	500
NR4BL-L		4x4	50	500
Plastic Bolts and Nuts				
F14PWN-L	1/4" plastic bolts and wing nuts fastens channel and fittings together for added strength and rigidity.	2x2 4x4	50	500
Plastic Bolts and Nuts				
F14PN-L	1/4" plastic bolts and hex nuts fastens channel and fittings together for added strength and rigidity.	2x2 4x4	50	500

A.
System
Overview

B1.
Cable Ties

B2.
Cable
Accessories

B3.
Stainless
Steel Ties

C1.
Wiring
Duct

C2.
Surface
Raceway

C3.
Abrasion
Protection

C4.
Cable
Management

D1.
Terminals

D2.
Power
Connectors

D3.
Grounding
Connectors

E1.
Labeling
Systems

E2.
Labels

E3.
Pre-Printed
& Write-On
Markers

E4.
Permanent
Identification

E5.
Lockout/
Tagout
& Safety
Solutions

F.
Index

A. System Overview

FIBER-DUCT™ Mounting Brackets

B1. Cable Ties

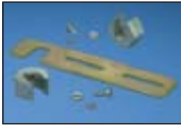

**FTRBE12, FTRBE58
FTRBE12M**

B2. Cable Accessories

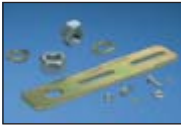

**FTRBN12, FTRBN58
FTRBN12M**

B3. Stainless Steel Ties

C1. Wiring Duct



FUSB

C2. Surface Raceway

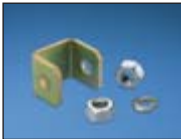

**FLB12X15
FLB58X15
FLB12X20
FLB58X20**

C3. Abrasion Protection

C4. Cable Management

D1. Terminals

D2. Power Connectors



FLRB

D3. Grounding Connectors

E1. Labeling Systems

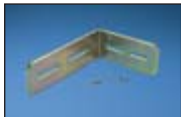

FLB

E2. Labels



FZBA1.5X4

E3. Pre-Printed & Write-On Markers

E4. Permanent Identification



FZBLP

E5. Lockout/Tagout & Safety Solutions

F. Index

Part Number	Part Description	For Threaded Rod Size	Std. Pkg. Qty.	Std. Ctn. Qty.
Existing Threaded Rod Bracket for FIBER-DUCT™ System				
FTRBE12	Used for supporting the 2x2 and 4x4 FIBER-DUCT™ Systems from existing threaded rod installations.	1/2"	1	10
FTRBE58	Bracket is secured to threaded rod with two split nuts. Contains hardware for attaching to threaded rods and hardware for mounting channel to bracket.	5/8"	1	10
FTRBE12M		12mm	1	10
New Threaded Rod Bracket for FIBER-DUCT™ System				
FTRBN12	Used for supporting the 2x2 and 4x4 FIBER-DUCT™ Systems from new threaded rod installations.	1/2"	1	10
FTRBN58	Bracket is secured to threaded rod with two nuts. Contains hardware for attaching to threaded rods and hardware for mounting channel to bracket.	5/8"	1	10
FTRBN12M		12mm	1	10
Underfloor Pedestal Bracket for FIBER-DUCT™ System				
FUSB	Used to support the 2x2 and 4x4 FIBER-DUCT™ Systems by attaching to underfloor pedestal (not included). Use on pedestals up to 1" in diameter. Bracket contains hardware to attach to pedestal and hardware for mounting channel to bracket.	—	1	10
Bracket for Attaching Threaded Rod to 1 1/2" Ladder Rack				
FLB12X15	Bracket attaches to 3/8" (9.5mm) wide x 1 1/2" (38.1mm) ladder rack rail. Bracket accepts threaded rod (not included). Contains bracket and hardware for attaching bracket to ladder rack.	1/2"	1	10
FLB58X15		5/8"	1	10
Bracket for Attaching Threaded Rod to 2" Ladder Rack				
FLB12X20	Bracket attaches to 3/8" (9.5mm) wide x 2" (50.8mm) ladder rack rail. Bracket accepts threaded rod (not included). Contains bracket and hardware for attaching bracket to ladder rack.	1/2"	1	10
FLB58X20		5/8"	1	10
Ladder Rack Bracket for FIBER-DUCT™ System				
FLRB	Used to support the 2x2 and 4x4 FIBER-DUCT™ Systems attaching directly to any 3/8" (9.5mm) x 1 1/2" (38.1mm) or 3/8" (9.5mm) x 2" (50.8mm) ladder rack rail. No threaded rod required. Contains hardware for mounting channel to bracket.	—	1	10
"L" Wall Mount Bracket for FIBER-DUCT™ System				
FLB	Used to support 2x2 and 4x4 FIBER-DUCT™ Systems by attaching to a wall or the front or back of an equipment rack. Contains hardware for mounting channel to bracket.	—	1	10
Adjustable "Z" Bracket				
FZBA1.5X4	Bracket used to offset FIBER-DUCT™ System from mounting surface, adjustable from 1.5" (38mm) to 4" (101mm). Typically used on the front of an equipment rack.	—	1	10
Low Profile "Z" Bracket				
FZBLP	Bracket used to offset 2x2 or 4x4 FIBER-DUCT™ System and hinged duct from the front face of an equipment rack. Bracket provides a secure mounting surface .67" (17mm) from the front of an equipment rack.	—	1	10

FIBER-DUCT™ Mounting Brackets (continued)



FEIAB58

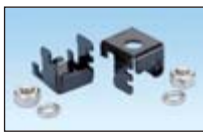

F2PCLB12
F2PCLB58



FRAFC58

Part Number	Part Description	For Threaded Rod Size	Std. Pkg. Qty.	Std. Ctn. Qty.
EIA/TIA Threaded Rod Mounting Bracket				
FEIAB58	Bracket consists of two identical components that clamp onto the crossmembers of standard EIA/TIA racks and are secured with standard hex nuts and split lockwashers (included) tightened onto a length of 5/8" diameter threaded rod (not included). The threaded rod is positioned in the center of the brackets providing a vertical threaded rod stud to mount <i>FIBERRUNNER</i> ® and <i>FIBER-DUCT</i> ™ Threaded Rod Mounting Brackets onto.	5/8"	1	10
Two-Piece Ladder Rack Bracket for Attaching Threaded Rod to 1 1/2" – 2" Ladder Rack				
F2PCLB12	Two-piece bracket attaches to 3/8" (9.5mm) wide x 1 1/2" (38.1mm) or 3/8" (9.5mm) wide x 2" (50.8mm) ladder rack rail. Bracket halves slide into position and clamp together on the ladder rack rail, which allows for a one-handed assembly of the threaded rod (not included). Contains bracket and hardware for attaching bracket to ladder rack.	1/2"	1	10
F2PCLB58		5/8"	1	10
Two-Piece Framing Clip for Attaching 5/8" Threaded Rod to 2" x 9/16" C-Channel Auxiliary Framing Bars				
FRAFC58	Two-piece framing clip attaches to auxiliary framing bars. Framing clip halves slide into position and interlock on the auxiliary framing bars, allowing easier assembly of the threaded rod to bars. Contains two-piece framing clip and hardware for attaching framing clip to auxiliary framing bars. (5/8" threaded rod not included.)	5/8"	1	10

A.
System
Overview

B1.
Cable Ties

B2.
Cable
Accessories

B3.
Stainless
Steel Ties

C1.
Wiring
Duct

C2.
Surface
Raceway

C3.
Abrasion
Protection

C4.
Cable
Management

D1.
Terminals

D2.
Power
Connectors

D3.
Grounding
Connectors

E1.
Labeling
Systems

E2.
Labels

E3.
Pre-Printed
& Write-On
Markers

E4.
Permanent
Identification

E5.
Lockout/
Tagout
& Safety
Solutions

F.
Index

A. System Overview



2x2 and 4x4 FIBER-DUCT™ Routing Systems

B1. Cable Ties

Cable Fills for 2x2 and 4x4 FIBER-DUCT™ Cable Routing Systems

The maximum amounts may vary according to the cable fill installation methods, straightness of cables, etc.

B2. Cable Accessories

B3. Stainless Steel Ties

C1. Wiring Duct

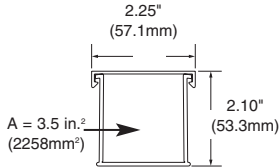

C2. Surface Raceway

C3. Abrasion Protection

C4. Cable Management

2x2 FIBER-DUCT™ Cable Routing System							
Fill/Pile Up	Internal Area in.²	Diameter 1.6mm .063"	Diameter 2.0mm .079"	Diameter 3.0mm .118"	Fiber Optic Flat Ribbon Interconnect Cable 5.20mm .205"	Category 6A 23 AWG* Diameter 8.38mm .330"	Category 6 Diameter 6.35mm .250"
40% Fill							
2" Pile Up	3.5	449	288	128	42	16	29
50% Fill							
2" Pile Up	3.5	562	359	160	53	20	36
60% Fill							
2" Pile Up	3.5	674	431	192	64	25	43

Channel cutting instructions: For optimum results, use a miter box and saw. For larger quantities use a plastic cutting saw blade for clean, burr-free cuts. Recommend: Carbide 80T and 100T; .090" thickness, .125" kerf.

*AWG dimensions represent typical outer cable diameter.

D1. Terminals

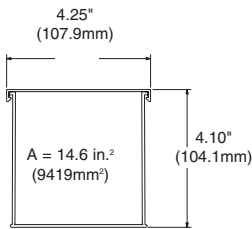

D2. Power Connectors

D3. Grounding Connectors

E1. Labeling Systems

E2. Labels

E3. Pre-Printed & Write-On Markers

E4. Permanent Identification

E5. Lockout/ Tagout & Safety Solutions

F. Index

4x4 FIBER-DUCT™ Cable Routing System							
Fill/Pile Up	Internal Area in.²	Diameter 1.6mm .063"	Diameter 2.0mm .079"	Diameter 3.0mm .118"	Fiber Optic Flat Ribbon Interconnect Cable 5.20mm .205"	Category 6A 23 AWG* Diameter 8.38mm .330"	Category 6 Diameter 6.35mm .250"
40% Fill							
2" Pile Up	7.60	976	624	277	92	36	62
3" Pile Up	11.30	1450	928	413	137	53	92
4" Pile Up	14.60	1874	1199	533	177	68	119
50% Fill							
2" Pile Up	7.60	1219	780	347	115	44	77
3" Pile Up	11.30	1813	1160	516	171	66	115
4" Pile Up	14.60	2343	1499	666	221	85	149
60% Fill							
2" Pile Up	7.60	1463	936	416	138	53	93
3" Pile Up	11.30	2176	1392	619	205	79	138
4" Pile Up	14.60	2811	1799	800	265	102	178

Channel cutting instructions: For optimum results, use a miter box and saw. For larger quantities use a plastic cutting saw blade for clean, burr-free cuts. Recommend: Carbide 80T and 100T; .090" thickness, .125" kerf.

*AWG dimensions represent typical outer cable diameter.

PAN-WAY® METAL RACEWAY

PAN-WAY® Metal Raceway is a series of single and multi-channel solutions for routing, protecting, concealing and terminating power wire and high performance copper, voice, video or fiber optic cable. PANDUIT metal raceway is designed with labor saving features to increase productivity and lower installed costs, while incorporating benefits of increased safety and cable protection. PAN-WAY® Metal Raceway is an innovative routing solution that offers superior benefits over competitive systems:

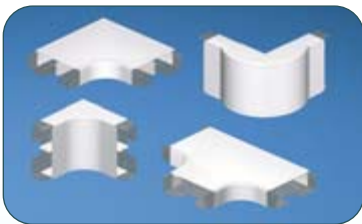

PAN-WAY® Metal Raceway systems include a complete assortment of fittings, junction boxes, faceplates and accessories. They are available in white and almond color to match any decor and most popular electrical outlets. Systems are optimized for use with PANDUIT® MINI-COM® Modules for complete connectivity possibilities.

PMR5 and PMR7 Single Channel Metal Raceway

- Raceway system features a patent pending bonding design that provides full continuity of the ground path between fittings and channel, for increased electrical safety
- System components incorporate an innovative snap-mount assembly method for fast installations, resulting in measurable contractor labor savings
- Fittings and mounts can be attached using various types and sizes of fasteners, eliminating the requirements of using only flat head style screws
- One-piece channel construction eliminates the problem of channel separation, associated with competitive two-piece designs, saving installation time

PMR40 Multi-Channel Metal Raceway

- Raceway accepts standard double gang faceplates for increased termination options and reduced number of components
- System includes optional faceplates and fittings to support high performance Category 6A copper and fiber optic cabling terminations
- Full capacity 2 inch bend radius fittings provide necessary cable protection without restricting channel capacity

A.
System
Overview

B1.
Cable Ties

B2.
Cable
Accessories

B3.
Stainless
Steel Ties

C1.
Wiring
Duct

C2.
Surface
Raceway

C3.
Abrasion
Protection

C4.
Cable
Management

D1.
Terminals

D2.
Power
Connectors

D3.
Grounding
Connectors

E1.
Labeling
Systems

E2.
Labels

E3.
Pre-Printed
& Write-On
Markers

E4.
Permanent
Identification

E5.
Lockout/
Tagout
& Safety
Solutions

F.
Index

A.
System
Overview

PMR40 Raceway Roadmap

B1.
Cable Ties

B2.
Cable
Accessories

B3.
Stainless
Steel Ties

C1.
Wiring
Duct

C2.
Surface
Raceway

C3.
Abrasion
Protection

C4.
Cable
Management

D1.
Terminals

D2.
Power
Connectors

D3.
Grounding
Connectors

E1.
Labeling
Systems

E2.
Labels

E3.
Pre-Printed
& Write-On
Markers

E4.
Permanent
Identification

E5.
Lockout/
Tagout/
& Safety
Solutions

F.
Index

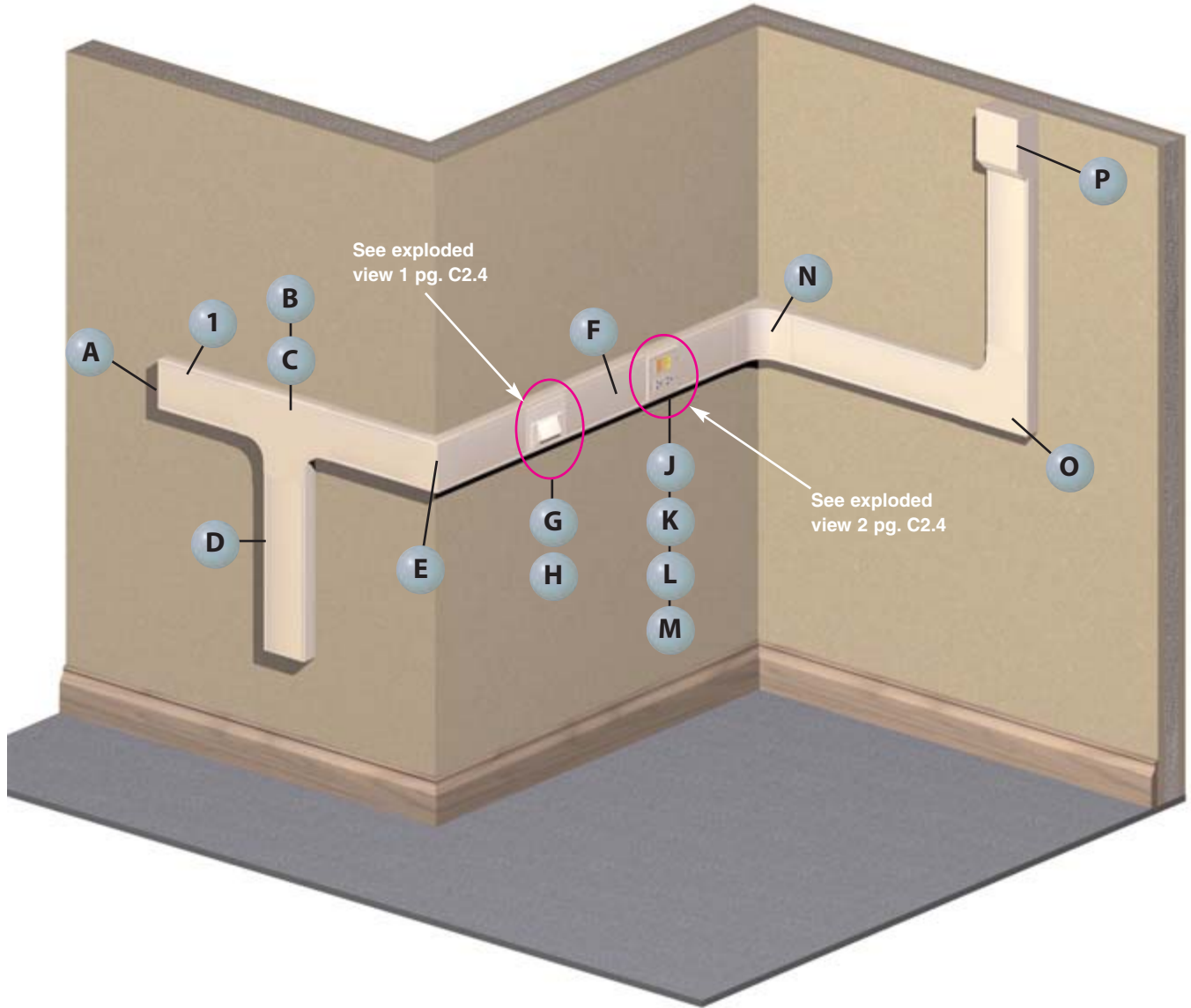

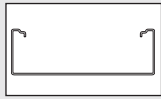

1 PMR40** – PMR40 Metal Raceway (page C2.5)

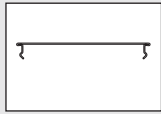

1 PMR40C** – PMR40 Cover (page C2.5)

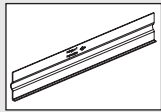

1 PMR40DW* – PMR40 Divider Wall (page C2.5)

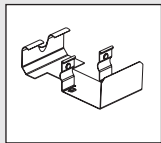

1 PMR40CD-X – PMR40 Divider Clip (page C2.5)

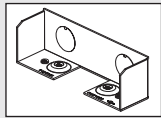

A PMR40EC** – End Cap (page C2.6)

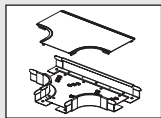

B PMR40T** – Tee Fitting (page C2.6)

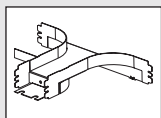

C PMR40TD50 – Tee Divider Insert (page C2.6)

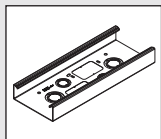

D PMR40BF** – Backfeed Fitting (page C2.6)

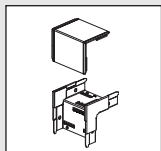

E PMR40SOC** – Outside Corner (no bend radius) (page C2.6)

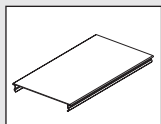

F PMR40C**7.5 – Pre-Cut Cover for mounting devices on 12" centers (page C2.5)

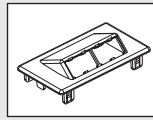

G PMR40FH4** – Horizontal Sloped Communication Faceplate (page C2.6)

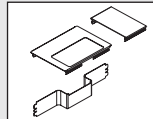

H PMR40DP50** – PMR40 50/50 Data Plate (page C2.6)

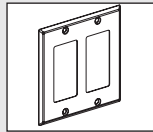

J MP2GR** – Double Gang Rectangular Faceplate (page C2.17)

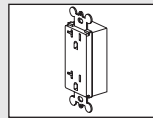

K ERU20** – 20 V Specification Grade Rectangular Outlet (page C2.60)

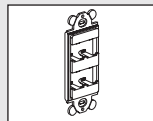

L CFG4 – MINI-COM® Frame

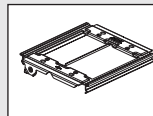

M PMR40DB50 – Device Bracket (page C2.6)

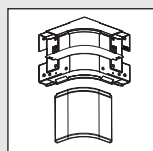

N PMR40IC** – Inside Corner (page C2.6)

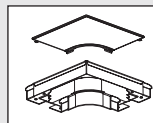

O PMR40RA** – Right Angle (page C2.5)

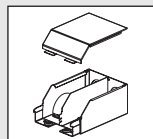

P PMR40EE** – Entrance End (page C2.6)

A. System Overview

B1. Cable Ties

B2. Cable Accessories

B3. Stainless Steel Ties

C1. Wiring Duct

C2. Surface Raceway

C3. Abrasion Protection

C4. Cable Management

D1. Terminals

D2. Power Connectors

D3. Grounding Connectors

E1. Labeling Systems

E2. Labels

E3. Pre-Printed & Write-On Markers

E4. Permanent Identification

E5. Lockout/Tagout & Safety Solutions

F. Index

A.
System
Overview

PMR40 Configurations

B1.
Cable Ties

Exploded View 1

	Components Required	See page
A.	PMR40FH4 = Horizontal sloped communication faceplate.	C2.6
B.	PMR40DP50** = PMR40 50/50 data plate and offset divider wall.	C2.6
C.	MINI-COM® Modules.	—

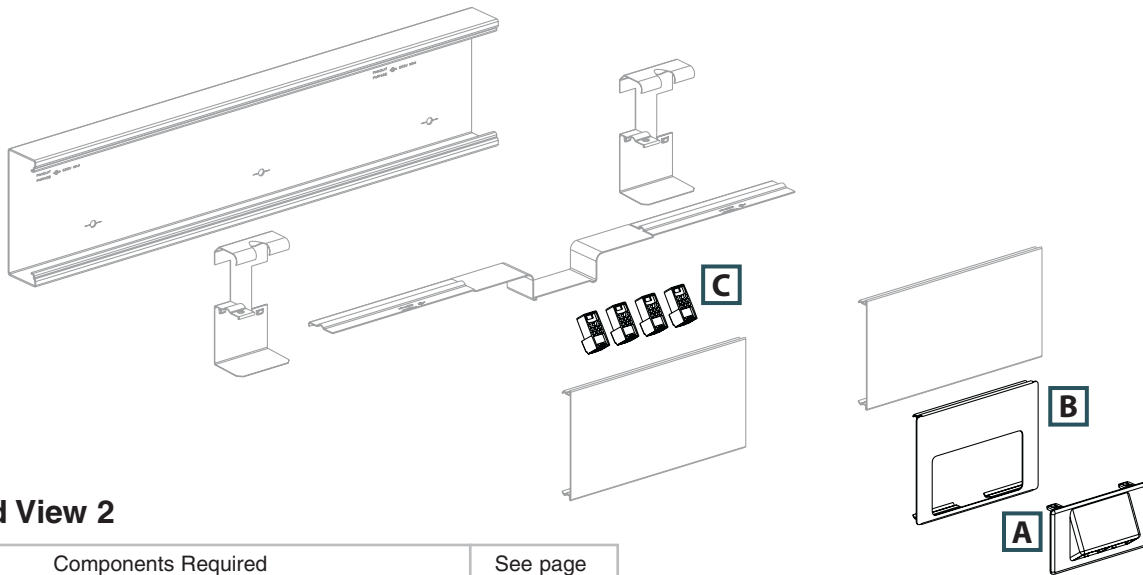

C1.
Wiring
Duct

C2.
Surface
Raceway

C3.
Abrasion
Protection

C4.
Cable
Management

D1.
Terminals

Exploded View 2

	Components Required	See page
A.	MP2GR** = Double gang rectangular faceplate.	C2.17
B.	ERU20** = 20 V specification grade rectangular outlet.	C2.60
C.	CFG4 = MINI-COM® Frame.	—
D.	MINI-COM® Modules.	—
E.	PMR40DB50-X = Device bracket.	C2.6

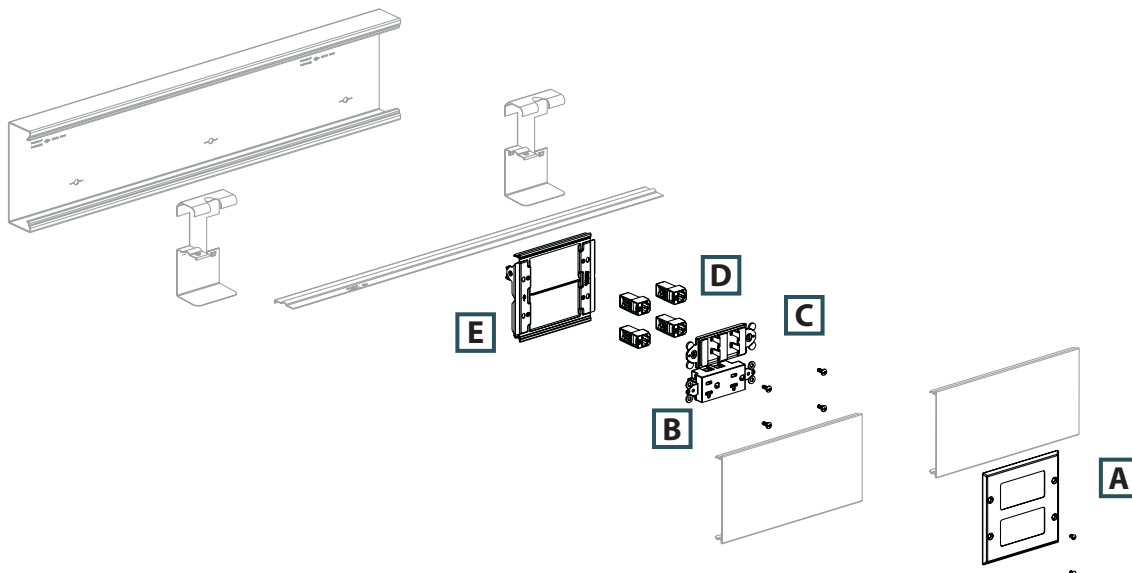

E1.
Labeling
Systems

E2.
Labels

E3.
Pre-Printed
& Write-On
Markers

E4.
Permanent
Identification

E5.
Lockout/
Tagout/
& Safety
Solutions

F.
Index

cUL^{us} PAN-WAY® PMR40 Metal Raceway System

- c-UL-us listed and rated to 600 V; meets UL 5 and CSA22.2 No. 62-93 safety standards
- Raceway accepts standard double gang faceplates for increased termination options and reduced number of components
- System includes optional faceplates and fittings to support high performance Category 6A copper and fiber optic cabling terminations

- Full capacity 2 inch bend radius fittings provide necessary cable protection without restricting channel capacity
- Supplied with pre-punched mounting holes

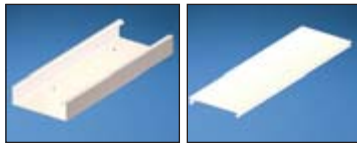
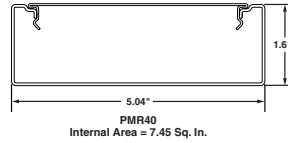

PMR40B

PMR40C

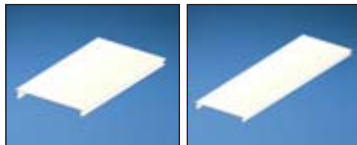

PMR40C***

PMR40C***

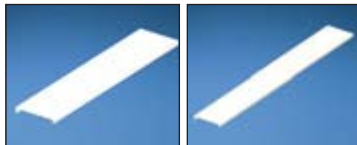

PMR40C***

PMR40C***



PMR40DW5

PMR40DC

Part Number	Part Description	Raceway Size	Color‡	Length (Ft.)	Std. Pkg. Qty.
PMR40 Metal Raceway Base					
PMR40BWH10	PMR40 raceway base available in 10' lengths. Supplied with pre-punched mounting holes.	5.04" x 1.61" (128.0mm x 40.9mm)	White	10	10
PMR40 Metal Raceway Cover					
PMR40CWH5	PMR40 raceway cover available in 5' lengths.	—	White	5	5
PMR40 Metal Raceway Pre-Cut Covers					
PMR40CWH7.75	7.75" pre-cut cover. To be used with PMR40 raceway for mounting devices on 12" centers.	—	White	—	1
PMR40CWH13.75	13.75" pre-cut cover. To be used with PMR40 raceway for mounting devices on 18" centers.	—	White	—	1
PMR40CWH19.75	19.75" pre-cut cover. To be used with PMR40 raceway for mounting devices on 24" centers.	—	White	—	1
PMR40CWH31.75	31.75" pre-cut cover. To be used with PMR40 raceway for mounting devices on 36" centers.	—	White	—	1
PMR40 Metal Raceway Divider Wall					
PMR40DW5	PMR40 divider wall snaps into PMR40DC-X to create separate channels. Must use wire retainers to ensure channel separation per UL/CSA. Available in 5' lengths.	—	Gray	5	5
Divider Wall Clip					
PMR40DC-X	Divider wall clip. Required for supporting PMR40DW. 30" spacing recommended between clips.	—	Gray	—	10

‡For other colors replace WH (White) with AL (Almond). Order number of feet required in multiples of standard carton quantity. Order raceway base and cover separately.

cUL^{us} PAN-WAY® PMR40 Metal Raceway Fittings

- PMR40 fittings are designed to exceed the TIA/EIA-568-B and 569-B required minimum bend radius for high performance copper and fiber optic cabling systems

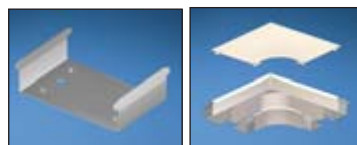

PMR40BC

PMR40RA



PMR40SIC

Part Number	Part Description	Color‡	Std. Pkg. Qty.	Std. Ctn. Qty.
PMR40BC	Base coupler. Used to join sections of PMR40 raceway base.	Gray	10	100
PMR40RAWH	Right angle fitting. Used to join sections of PMR40 raceway at right angles.	White	1	10
PMR40SIC	Inside corner fitting without bend radius control. Used to join sections of PMR40 raceway at inside corners.	White	1	10

‡For other colors replace WH (White) with AL (Almond).

Table continues on page C2.6

A. System Overview

B1. Cable Ties

B2. Cable Accessories

B3. Stainless Steel Ties

C1. Wiring Duct

C2. Surface Raceway

C3. Abrasion Protection

C4. Cable Management

D1. Terminals

D2. Power Connectors

D3. Grounding Connectors

E1. Labeling Systems

E2. Labels

E3. Pre-Printed & Write-On Markers

E4. Permanent Identification

E5. Lockout/Tagout & Safety Solutions

F. Index



PAN-WAY® PMR40 Metal Raceway Fittings (continued)

A. System Overview

B1. Cable Ties

B2. Cable Accessories

B3. Stainless Steel Ties

C1. Wiring Duct

C2. Surface Raceway

C3. Abrasion Protection

C4. Cable Management

D1. Terminals

D2. Power Connectors

D3. Grounding Connectors

E1. Labeling Systems

E2. Labels

E3. Pre-Printed & Write-On Markers

E4. Permanent Identification

E5. Lockout/Tagout & Safety Solutions

F. Index



PMR40IC

PMR40I45E

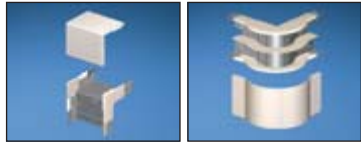

PMR40SOC

PMR40OC

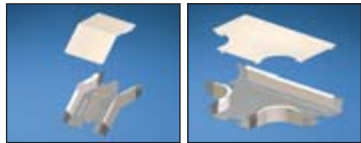

PMR40E45E

PMR40T



PMR40TD50

PMR40EC



PMR40EE

PMR40TR



PMR40BF

PMR40PC



PMR40ICC

PMR40WR

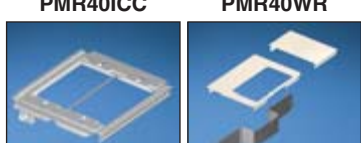

PMR40DB50

PMR40DP50



PMR40FH2

PMR40FH4



PMR40KH2

PMR40KH4

Part Number	Part Description	Color†	Std. Pkg. Qty.	Std. Ctn. Qty.
PMR40ICWH	Inside corner fitting. Used to join sections of PMR40 raceway at inside corners.	White	1	10
PMR40I45EWH	Internal 45° elbow fitting. Used to join sections of PMR40 raceway at 45° inside corners.	White	1	10
PMR40SOCWH	Outside corner fitting without bend radius control. Used to join sections of PMR40 raceway at outside corners.	White	1	10
PMR40OCWH	Outside corner fitting. Used to join sections of PMR40 raceway at outside corners.	White	1	10
PMR40E45EWH	External 45° elbow fitting. Used to join sections of PMR40 raceway at 45° outside corners.	White	1	10
PMR40TWH	Tee fitting. Used to join sections of PMR40 raceway at tee intersections.	White	1	10
PMR40TD50	Tee divider insert for a 50/50 data/power split. Maintains a 50/50 channel separation for power and data applications.	Gray	1	10
PMR40ECWH	End cap fitting. Used to terminate or allow entry into PMR40 raceway. Breakouts for 1/2" conduit.	White	1	10
PMR40EEWH	Entrance end fitting. Breakouts for 3/4", 1", and 1 1/4" conduit which allows entry from ceiling or wall.	White	1	10
PMR40TRWH	WIREMOLD* to PMR40 transition fitting. In-line transition fitting from Wiremold* 4000 series to PMR40 raceway.	White	1	10
PMR40BFWH	Backfeed fitting. Allows cable entry through the back of the PMR40 raceway. Two round breakouts for 1/2", 3/4", and 1" conduit, two round breakouts for 3/4", 1", and 1 1/4" conduit and two 1 11/16" x 2 9/16" rectangular breakouts.	White	1	10
PMR40PCWH	Panel connector. To connect PMR40 raceway with surface type panel boxes.	White	1	10
PMR40ICC	Internal corner coupling.	White	1	10
PMR40WR-X	Wire retainer. Used to hold wires in place during installation.	Gray	10	100
PMR40DB50	Device mounting bracket 50/50 split. Used to mount NEMA standard single gang electrical outlets and communication devices with either screw-on or snap-on single gang faceplates.	Gray	1	10
PMR40DP50WH	PMR40 data plate for mounting data faceplates PMR40FH2, PMR40FH4, PMR40KH2 or PMR40KH4 when a 50/50 split channel is used in the PMR40 base. Includes data plate, 2.50" pre-cut cover, and offset divider wall.	White	1	10
PMR40FH2WH	Snap-on horizontal sloped communication faceplate. Accepts two PANDUIT® MINI-COM® Modules (not included). No additional mounting hardware required.	White	1	10
PMR40FH4WH	Snap-on horizontal sloped communication faceplate. Accepts four PANDUIT® MINI-COM® Modules (not included). No additional mounting hardware required.	White	1	10
PMR40KH2WH	Snap-on horizontal sloped communication faceplate. Accepts two Keystone modules (not included). No additional mounting hardware required.	White	1	10
PMR40KH4WH	Snap-on horizontal sloped communication faceplate. Accepts four Keystone modules (not included). No additional mounting hardware required.	White	1	10

†For other colors replace WH (White) with AL (Almond).

*WIREMOLD is a registered trademark of the Wiremold Co.

Cable Fill Capacities for PMR40 Metal Raceway

This information is to be used as a guide in selecting the proper size raceway. The maximum amounts may vary according to the cable installation methods, straightness of cables, etc.



A = 7.45 in.²

Cable fill #1: Open channel without devices



A = 6.18 in.²

Cable fill #2: Undivided, wire retainer only

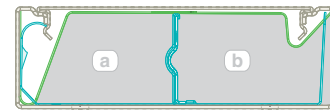

A = 2.64 in.²

B = 3.04 in.²

Cable fill #3: Divided with wire retainer

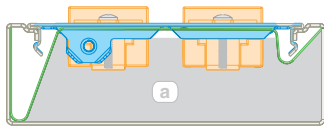

A = 4.64 in.²

Cable fill #4: Undivided with duplex receptacle on two sides

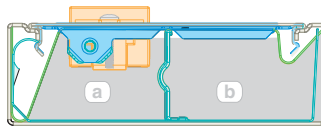

A = 1.87 in.²

B = 2.84 in.²

Cable fill #5: Divided with duplex receptacle on (A) side

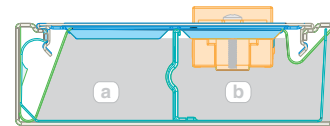

A = 2.49 in.²

B = 2.21 in.²

Cable fill #6: Divided with duplex receptacle on (B) side

SPEC = 40% cable fill – Recommended by TIA/EIA-569-B for design.

MAX for 60% cable fill – Recommended by TIA/EIA-569-B for unplanned additions.

MAX for 40% power cable fill – Based on available internal area.

Raceway Type and Configuration	Fill Area (in. ²)	Electrical Cables			Data Grade Cables		Data Grade Cables		Audio/Video	
		14 AWG	12 AWG	10 AWG	24 AWG/UTP CM		24 AWG/UTP CM		RG6	
		THHN/T90			Category 6		Category 6A		Dia. = 0.275	
		0.111	0.130	0.164	Dia. = 0.250		Dia. = 0.330		Dia. = 0.275	
		FILL			FILL		FILL		FILL	
		MAX 40%	MAX 40%	MAX 40%	SPEC 40%	MAX 60%	SPEC 40%	MAX 60%	SPEC 40%	MAX 60%
1. PMR40 – Undivided (base and cover)	7.45	307	224	140	60	91	34	52	50	75
2. PMR40 – Undivided, wire retainer only	6.18	255	186	117	50	75	28	43	41	62
3a. PMR40 – Divided, with wire retainer	2.64	109	79	50	21	32	12	18	17	26
	3b.	3.04	125	91	57	24	37	14	21	20
4. PMR40 – Undivided with duplex receptacle two sides	4.64	191	139	87	—	—	—	—	—	—
5a. PMR40 – Divided with duplex receptacle on (A) side	1.87	78	57	36	—	—	—	—	—	—
	5b.	2.84	—	—	—	23	34	13	19	19
6a. PMR40 – Divided with duplex receptacle on (B) side	2.49	—	—	—	20	30	11	17	16	25
	6b.	2.21	91	66	41	—	—	—	—	—

AWG dimensions represent typical outer cable diameter in inches.

A.
System
Overview

PMR5/7 Raceway Roadmap

B1.
Cable Ties

B2.
Cable
Accessories

B3.
Stainless
Steel Ties

C1.
Wiring
Duct

C2.
Surface
Raceway

C3.
Abrasion
Protection

C4.
Cable
Management

D1.
Terminals

D2.
Power
Connectors

D3.
Grounding
Connectors

E1.
Labeling
Systems

E2.
Labels

E3.
Pre-Printed
& Write-On
Markers

E4.
Permanent
Identification

E5.
Lockout/
Tagout/
& Safety
Solutions

F.
Index

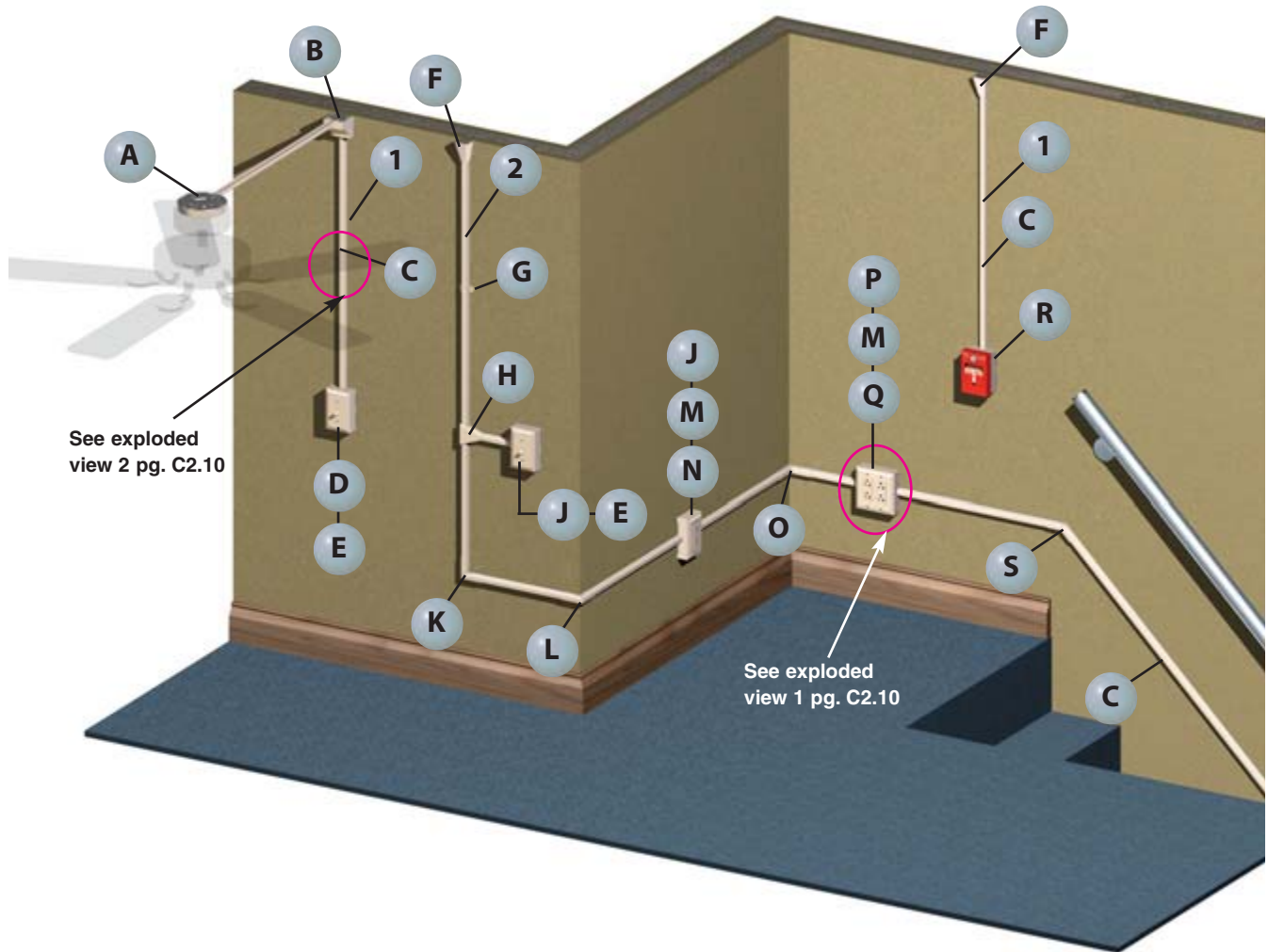

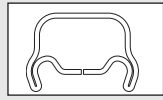

1 PMR5** – PMR5 Metal Raceway (page C2.11)

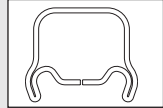

2 PMR7** – PMR7 Metal Raceway (page C2.11)



A PMR5738A** – Round Fan/Fixture Box (page C2.16)

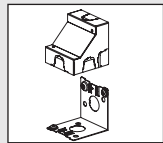

B PMR57CB** – Corner Box (page C2.12)

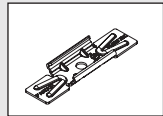

C PMR57SC-X – Supporting Clip (page C2.11)

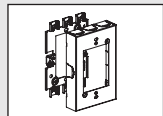

D PMR5751** – Single Gang Extension Box (page C2.15)

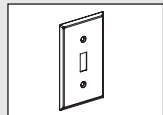

E MP1TS** – Single Gang Toggle Switch Faceplate (page C2.17)

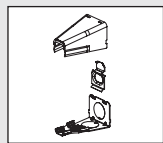

F PMR57EE – Entrance End Fitting (page C2.12)

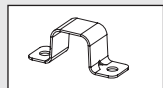

G PMR7MS** – Mounting Strap (page C2.11)

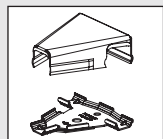

H PMR57T** – Tee Fitting (page C2.12)

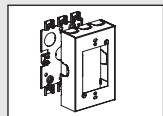

J PMR5747** – Single Gang Shallow Outlet Box (page C2.15)

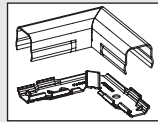

K PMR7RA** – Right Angle Fitting (page C2.12)

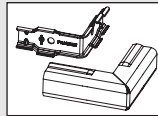

L PMR7OC** – Outside Corner Fitting (page C2.12)

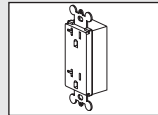

M ERU20** – 20 V Specification Grade Rectangular Outlet (page C2.60)

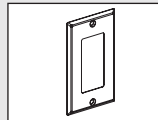

N MP1GR** – Single Gang Rectangular Faceplate (page C2.17)

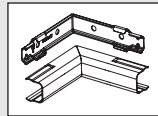

O PMR7IC** – Inside Corner Fitting (page C2.12)

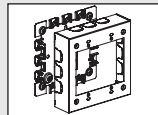

P PMR5747-2** – Double Gang Shallow Outlet Box (page C2.16)

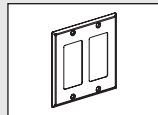

Q MP2GR** – Double Gang Rectangular Faceplate (page C2.17)

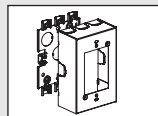

R PMR5748** – Single Gang Outlet Box (page C2.15)

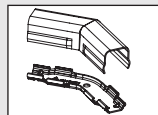

S PMR7DA** – Diagonal 45° Angle Fitting (page C2.12)

A. System Overview

B1. Cable Ties

B2. Cable Accessories

B3. Stainless Steel Ties

C1. Wiring Duct

C2. Surface Raceway

C3. Abrasion Protection

C4. Cable Management

D1. Terminals

D2. Power Connectors

D3. Grounding Connectors

E1. Labeling Systems

E2. Labels

E3. Pre-Printed & Write-On Markers

E4. Permanent Identification

E5. Lockout/Tagout & Safety Solutions

F. Index

A.
System
Overview

PMR5/PMR7 Configurations

B1.
Cable Ties

Exploded View 1

B2.
Cable
Accessories

	Components Required	See page
A.	MP2GR = Double gang rectangular faceplate.	C2.17
B.	ERU20 = 20 A Specification rectangular outlet.	C2.60
C.	PMR5747-2 = Double gang deep outlet box.	C2.16

B3.
Stainless
Steel Ties

C1.
Wiring
Duct

C2.
Surface
Raceway

C3.
Abrasion
Protection

C4.
Cable
Management

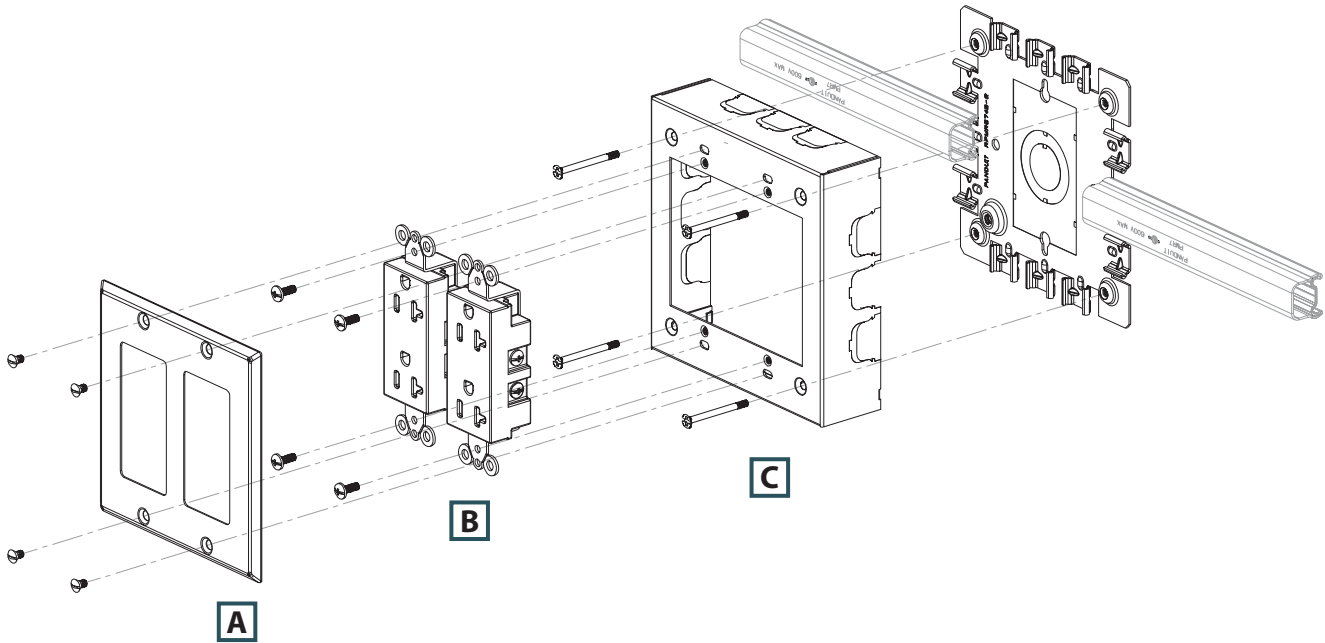

D1.
Terminals

D2.
Power
Connectors

Exploded View 2

D3.
Grounding
Connectors

	Components Required	See page
A.	PMR57SC-X = Supporting clip.	C2.11
B.	PMR7*** = PMR7 metal raceway.	C2.11

E1.
Labeling
Systems

E2.
Labels

E3.
Pre-Printed
& Write-On
Markers

E4.
Permanent
Identification

E5.
Lockout/
Tagout/
& Safety
Solutions

F.
Index

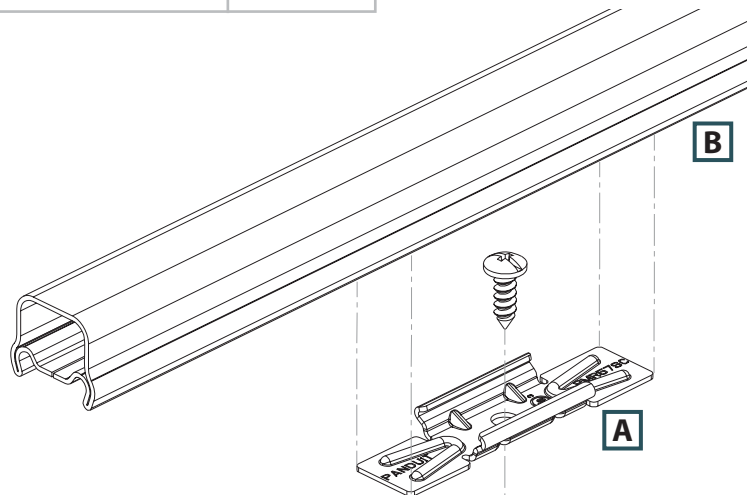

c-UL^{us} PAN-WAY® PMR5/PMR7 Metal Raceway System



- c-UL-us listed and rated to 600 V; meets UL 5 and CSA22.2 No. 62-93 safety standards
- Raceway system features a patent pending bonding design that provides full continuity of the ground path between fittings and channel, for increased electrical safety
- System components incorporate a unique snap mount assembly method for faster installation

- Fittings and mounts can be attached using various types and sizes of fasteners, eliminating the requirements of using only flat head style screws
- One-piece channel construction eliminates the problem of channel separation, associated with competitive two-piece designs, saving installation time

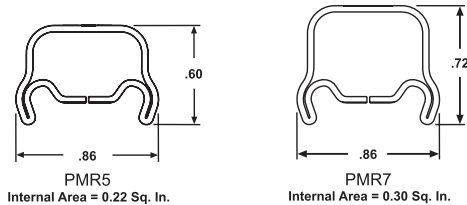

PMR5



PMR7



PMR57SC

PMR57JC

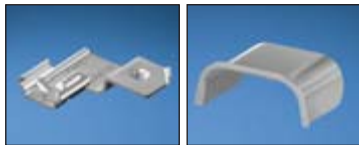

PMR57GC

PMR5WPB
PMR7WPB



PMR5MS
PMR7MS

Part Number	Part Description	Raceway Size	Color‡	Length (Ft.)	Std. Pkg. Qty.	Std. Ctn. Qty.
PMR5 Metal Raceway						
PMR5WH5	One-piece single channel metal surface raceway. Available in 5' lengths.	.86" x .60" (21.8mm x 15.2mm)	White	5	5	50
PMR5WH10	One-piece single channel metal surface raceway. Available in 10' lengths.	.86" x .60" (21.8mm x 15.2mm)	White	10	10	100
PMR7 Metal Raceway						
PMR7WH5	One-piece single channel metal surface raceway. Available in 5' lengths.	.86" x .72" (21.8mm x 18.3mm)	White	5	5	50
PMR7WH10	One-piece single channel metal surface raceway. Available in 10' lengths.	.86" x .72" (21.8mm x 18.3mm)	White	10	10	100
Supporting Clip						
PMR57SC-X	Supporting clip used to support lengths of PMR5 or PMR7 raceway at any desired point.	—	Gray	—	10	100
Joint Coupling						
PMR57JC-X	Joint coupling used to join two lengths of PMR5 or PMR7 raceway.	—	Gray	—	10	100
Ground Clip						
PMR57GC-X	Ground clip used to provide additional grounding of raceway or to ground remote installations. For use with PMR5 or PMR7 raceway.	—	Gray	—	10	100
Metal Bushing						
PMR5WPB-X	Bushing used to protect wires from abrasion. For use with PMR5 raceway.	—	Gray	—	10	100
PMR7WPB-X	Bushing used to protect wires from abrasion. For use with PMR7 raceway.	—	Gray	—	10	100
Mounting Strap						
PMR5MSWH-X	Mounting strap for use with PMR5 raceway.	—	White	—	10	100
PMR7MSWH-X	Mounting strap for use with PMR7 raceway.	—	White	—	10	100

‡For other colors replace WH (White) with AL (Almond).

A.
System
Overview

B1.
Cable Ties

B2.
Cable
Accessories

B3.
Stainless
Steel Ties

C1.
Wiring
Duct

C2.
Surface
Raceway

C3.
Abrasion
Protection

C4.
Cable
Management

D1.
Terminals

D2.
Power
Connectors

D3.
Grounding
Connectors

E1.
Labeling
Systems

E2.
Labels

E3.
Pre-Printed
& Write-On
Markers

E4.
Permanent
Identification

E5.
Lockout/
Tagout
& Safety
Solutions

F.
Index



PAN-WAY® PMR5/PMR7 Metal Raceway Fittings

A. System Overview

B1. Cable Ties

B2. Cable Accessories

B3. Stainless Steel Ties

C1. Wiring Duct

C2. Surface Raceway

C3. Abrasion Protection

C4. Cable Management

D1. Terminals

D2. Power Connectors

D3. Grounding Connectors

E1. Labeling Systems

E2. Labels

E3. Pre-Printed & Write-On Markers

E4. Permanent Identification

E5. Lockout/Tagout & Safety Solutions

F. Index

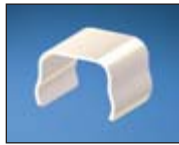

**PMR5CC
PMR7CC**

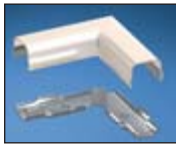

**PMR5RA
PMR7RA**



**PMR5DA
PMR7DA**



**PMR5IC
PMR7IC**

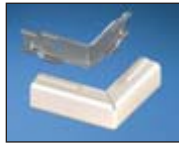

**PMR5OC
PMR7OC**

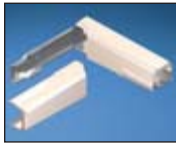

PMR57LTE



PMR57RTE

PMR57T



PMR57EE

PMR57AOC



PMR57CB

**PMR57TR
PMR7TR**



PMR57EBC

PMR57ECC



**PMR57JBC50
PMR57JBC75**



**PMR57CC50
PMR57CC75**

Part Number	Part Description	Color‡	Std. Pkg. Qty.	Std. Ctn. Qty.
PMR5CCWH-X	Coupler fitting for use with PMR5 raceway.	White	10	100
PMR7CCWH-X	Coupler fitting for use with PMR7 raceway.	White	10	100
PMR5RAWH	Right angle fitting for use with PMR5 raceway.	White	1	10
PMR7RAWH	Right angle fitting for use with PMR7 raceway.	White	1	10
PMR5DAWH	Diagonal 45° angle fitting for use with PMR5 raceway.	White	1	10
PMR7DAWH	Diagonal 45° angle fitting for use with PMR7 raceway.	White	1	10
PMR5ICWH	Inside corner fitting for use with PMR5 raceway.	White	1	10
PMR7ICWH	Inside corner fitting for use with PMR7 raceway.	White	1	10
PMR5OCWH	Outside corner fitting for use with PMR5 raceway.	White	1	10
PMR7OCWH	Outside corner fitting for use with PMR7 raceway.	White	1	10
PMR57LTEWH	Left twisted elbow for 90° twist with 90° turn. For double turn at right angles from one surface to another, such as a flat run on a sidewall to a flat run on a ceiling. For use with PMR5 and PMR7 raceway.	White	1	10
PMR57RTEWH	Right twisted elbow for 90° twist with 90° turn. For double turn at right angles from one surface to another, such as a flat run on a sidewall to a flat run on a ceiling. For use with PMR5 and PMR7 raceway.	White	1	10
PMR57TWH	Tee fitting for use with PMR5 or PMR7 raceway.	White	1	10
PMR57EEWH	Entrance end fitting. 1/2" conduit breakouts allows entry of PMR5 or PMR7 raceway from a box, the ceiling, or a wall. Spring steel bushing included for use when connecting to a box.	White	1	10
PMR57AOCWH	Adjustable offset allows PMR5 or PMR7 to be mounted flush to wall when connected to surface type panel boxes. Adjustable between 5/8" and 1 3/8" from surface to center of conduit. 1/2" chase nipple and locknut included.	White	1	10
PMR57CBWH	Corner box for connecting PMR5 or PMR7 raceway. Each leg has 1/2" conduit breakouts and room for splicing.	White	1	10
PMR57TRWH	WIREMOLD* to PMR5 transition fitting. In-line transition fitting from Wiremold* 500 series to PMR5 raceway.	White	1	10
PMR77TRWH	WIREMOLD* to PMR7 Transition fitting. In-line transition fitting from WIREMOLD* 700 series to PMR7 raceway.	White	1	10
PMR57EBCWH	Elbow box connector used to connect PMR5 or PMR7 raceway to boxes at a right angle. Breakouts for 1/2" conduit.	White	1	10
PMR57ECCWH	Elbow conduit connector used to connect PMR5 or PMR7 raceway to conduit at a right angle. Breakouts for 1/2" conduit.	White	1	10
PMR57JBC50-X	Junction box connector used to connect PMR5 or PMR7 raceway to boxes with 1/2" conduit breakout.	White	10	100
PMR57JBC75-X	Junction box connector used to connect PMR5 or PMR7 raceway to boxes with 3/4" conduit breakout.	White	10	100
PMR57CC50-X	Conduit connector used to connect PMR5 or PMR7 raceway to 1/2" conduit.	White	10	100
PMR57CC75-X	Conduit connector used to connect PMR5 or PMR7 raceway to 3/4" conduit.	White	10	100

‡For other colors replace WH (White) with AL (Almond).

*WIREMOLD is a registered trademark of the Wiremold Co.

cUL^{us} PMR5 and PMR7 Raceway Accessories



PMR57MRT

PMRTUP**

Part Number	Part Description	Color	Std. Pkg. Qty.	Std. Ctn. Qty.
PMR57MRT	Metal raceway tool. To aid in the installation and removal of PMR5 and PMR7 metal raceway base sections.	Black	1	10
PMRTUPAL	Touch-up paint pen. Used to repair areas of metal raceway where paint has been removed or damaged.	—	1	10
PMRTUPWH	Touch-up paint pen. Used to repair areas of metal raceway where paint has been removed or damaged.	—	1	10

A. System Overview

B1. Cable Ties

B2. Cable Accessories

B3. Stainless Steel Ties

C1. Wiring Duct

C2. Surface Raceway

C3. Abrasion Protection

C4. Cable Management

D1. Terminals

D2. Power Connectors

D3. Grounding Connectors

E1. Labeling Systems

E2. Labels

E3. Pre-Printed & Write-On Markers

E4. Permanent Identification

E5. Lockout/Tagout & Safety Solutions

F. Index

A.
System
Overview

Cable Fill Capacities for PMR5/PMR7 Metal Raceway

B1.
Cable Ties

This information is to be used as a guide in selecting the proper size raceway. The maximum amounts may vary according to the cable installation methods, straightness of cables, etc.

B2.
Cable
Accessories

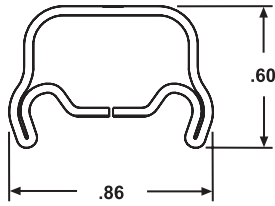

PMR5

$$A = .22 \text{ in.}^2$$

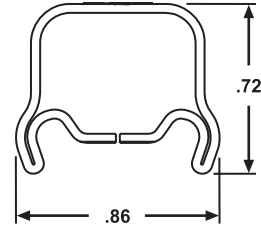

PMR7

$$A = .30 \text{ in.}^2$$

B3.
Stainless
Steel Ties

C1.
Wiring
Duct

C2.
Surface
Raceway

C3.
Abrasion
Protection

C4.
Cable
Management

SPEC = 40% cable fill – The recommended design in cable capacity, leaves room for future moves, adds, and changes.

MAX for Data = 60% cable fill – The maximum cable quantity based on cable interweaving and packing factors.

D1.
Terminals

D2.
Power
Connectors

D3.
Grounding
Connectors

Raceway Type and Configuration	Fill Area (In. ²)	Electrical Cables			Data Grade Cables		Data Grade Cables		Audio/Video		Fiber Optic Cable	
		14 AWG	12 AWG	10 AWG	24 AWG/UTP CM		24 AWG/UTP CM		RG6		2 Strand	
		THHN/T90			Category 6		Category 6A		Dia. = 0.275		Dia. = 0.175	
		0.111	0.130	0.164	Dia. = 0.250		Dia. = 0.330		FILL		FILL	
		FILL			FILL		FILL		FILL		FILL	
		MAX	MAX	MAX	SPEC	MAX	SPEC	MAX	SPEC	MAX	SPEC	MAX
PMR5	0.22	9	6	4	1	2	1	1	1	2	3	5
PMR7	0.30	12	8	5	2	3	1	2	2	3	4	7

AWG dimensions represent typical outer cable diameter in inches.

E1.
Labeling
Systems

E2.
Labels

E3.
Pre-Printed
& Write-On
Markers

E4.
Permanent
Identification

E5.
Lockout/
Tagout/
& Safety
Solutions

F.
Index

UL US **PAN-WAY® Metal Raceway Boxes**

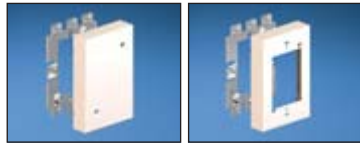

PMR5760

PMR5751

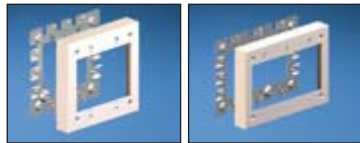

PMR5751-2

PMR5751-3

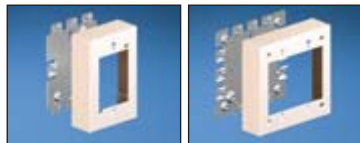

PMR5747

PMR5747-2

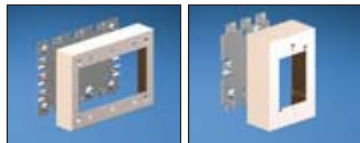

PMR5747-3

PMR5748

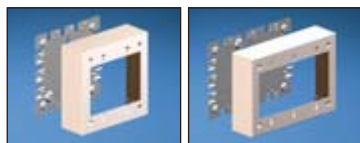

PMR5748-2

PMR5748-3

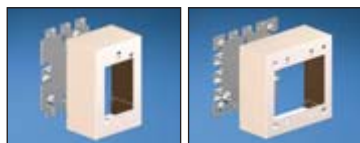

PMR5744S

PMR5744S-2

Part Number	Part Description	Color‡	Std. Pkg. Qty.	Std. Ctn. Qty.
PMR5760WH	Single gang blank extension box. For use with <i>PAN-WAY</i> ® PMR5 or PMR7 Raceway. 4.92"L x 3.17"W x .94"H (125.0mm x 80.5mm x 23.8mm)	White	1	10
PMR5751WH	Single gang extension box. Box accepts <i>PAN-WAY</i> ® Faceplates or any NEMA standard single gang faceplate. For use with <i>PAN-WAY</i> ® PMR5 or PMR7 Raceway. 4.92"L x 3.17"W x .94"H (125.0mm x 80.5mm x 23.8mm)	White	1	10
PMR5751-2WH	Double gang extension box. Box accepts <i>PAN-WAY</i> ® Faceplates or any standard double gang faceplate. For use with <i>PAN-WAY</i> ® PMR5 or PMR7 Raceway. 4.92"L x 4.92"W x .94"H (125.0mm x 125.0mm x 23.8mm)	White	1	10
PMR5751-3WH	Three gang extension box. Box accepts <i>PAN-WAY</i> ® Faceplates or any standard three gang faceplate. For use with <i>PAN-WAY</i> ® PMR5 or PMR7 Raceway. 4.92"L x 6.72"W x .94"H (125.0mm x 170.7mm x 23.8mm)	White	1	10
PMR5747WH	Single gang shallow outlet box. Box accepts <i>PAN-WAY</i> ® Faceplates or any NEMA standard single gang faceplate. For use with <i>PAN-WAY</i> ® PMR5 or PMR7 Raceway. Breakouts for 1/2" conduit. 4.92"L x 3.17"W x 1.38"H (125.0mm x 80.5mm x 34.9mm)	White	1	10
PMR5747-2WH	Double gang shallow outlet box. Box accepts <i>PAN-WAY</i> ® Faceplates or any standard double gang faceplate. For use with <i>PAN-WAY</i> ® PMR5 or PMR7 Raceway. Breakouts for 1/2" and 1" conduit. 4.92"L x 4.92"W x 1.38"H (125.0mm x 125.0mm x 34.9mm)	White	1	10
PMR5747-3WH	Three gang shallow outlet box. Box accepts <i>PAN-WAY</i> ® Faceplates or any standard three gang faceplate. For use with <i>PAN-WAY</i> ® PMR5 or PMR7 Raceway. Breakouts for 1/2" conduit. 4.92"L x 6.72"W x 1.38"H (125.0mm x 170.7mm x 34.9mm)	White	1	10
PMR5748WH	Single gang outlet box. Box accepts <i>PAN-WAY</i> ® Faceplates or any NEMA standard single gang faceplate. For use with <i>PAN-WAY</i> ® PMR5 or PMR7 Raceway. Breakouts for 1/2" conduit. 4.92"L x 3.17"W x 1.75"H (125.0mm x 80.5mm x 44.5mm)	White	1	10
PMR5748-2WH	Double gang outlet box. Box accepts <i>PAN-WAY</i> ® Faceplates or any standard double gang faceplate. For use with <i>PAN-WAY</i> ® PMR5 or PMR7 Raceway. Breakouts for 1/2" and 1" conduit. 4.92"L x 4.92"W x 1.75"H (125.0mm x 125.0mm x 44.5mm)	White	1	10
PMR5748-3WH	Three gang outlet box. Box accepts <i>PAN-WAY</i> ® Faceplates or any standard three gang faceplate. For use with <i>PAN-WAY</i> ® PMR5 or PMR7 Raceway. Breakouts for 1/2" conduit. 4.92"L x 6.72"W x 1.75"H (125.0mm x 170.7mm x 44.5mm)	White	1	10
PMR5744SWH	Single gang intermediate outlet box. Box accepts <i>PAN-WAY</i> ® Faceplates or any NEMA standard single gang faceplate. For use with <i>PAN-WAY</i> ® PMR5 or PMR7 Raceway. Breakouts for 1/2" conduit. 4.92"L x 3.17"W x 2.25"H (125.0mm x 80.5mm x 57.2mm)	White	1	10
PMR5744S-2WH	Double gang intermediate outlet box. Box accepts <i>PAN-WAY</i> ® Faceplates or any standard double gang faceplate. For use with <i>PAN-WAY</i> ® PMR5 or PMR7 Raceway. Breakouts for 1/2" and 1" conduit. 4.92"L x 4.92"W x 2.25"H (125.0mm x 125.0mm x 57.2mm)	White	1	10

‡For other colors replace WH (White) with AL (Almond).

A. System Overview

B1. Cable Ties

B2. Cable Accessories

B3. Stainless Steel Ties

C1. Wiring Duct

C2. Surface Raceway

C3. Abrasion Protection

C4. Cable Management

D1. Terminals

D2. Power Connectors

D3. Grounding Connectors

E1. Labeling Systems

E2. Labels

E3. Pre-Printed & Write-On Markers

E4. Permanent Identification

E5. Lockout/Tagout & Safety Solutions

F. Index

Table continues on page C2.16



PAN-WAY® Metal Raceway Boxes (continued)

- A. System Overview
- B1. Cable Ties
- B2. Cable Accessories
- B3. Stainless Steel Ties
- C1. Wiring Duct
- C2. Surface Raceway
- C3. Abrasion Protection
- C4. Cable Management
- D1. Terminals
- D2. Power Connectors
- D3. Grounding Connectors
- E1. Labeling Systems
- E2. Labels
- E3. Pre-Printed & Write-On Markers
- E4. Permanent Identification
- E5. Lockout/Tagout & Safety Solutions
- F. Index

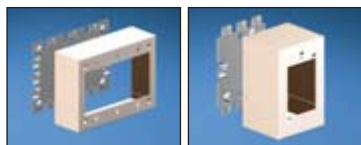

PMR5744S-3

PMR5744

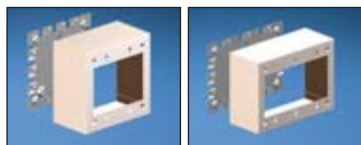

PMR5744-2

PMR5744-3



PMR5738

PMR5738A



PMR5739

PMR5737



PMR5737A

PMR5739A

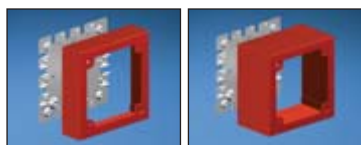

PMR5752

PMR5753

Part Number	Part Description	Color‡	Std. Pkg. Qty.	Std. Ctn. Qty.
PMR5744S-3WH	Three gang intermediate outlet box. Box accepts <i>PAN-WAY</i> ® Faceplates or any standard three gang faceplate. For use with <i>PAN-WAY</i> ® PMR5 or PMR7 Raceway. Breakouts for 1/2" conduit. 4.92"L x 6.72"W x 2.25"H (125.0mm x 170.7mm x 57.2mm)	White	1	10
PMR5744WH	Single gang deep outlet box. Box accepts <i>PAN-WAY</i> ® Faceplates or any NEMA standard single gang faceplate. For use with <i>PAN-WAY</i> ® PMR5 or PMR7 Raceway. Breakouts for 1/2" conduit. 4.92"L x 3.17"W x 2.75"H (125.0mm x 80.5mm x 69.9mm)	White	1	10
PMR5744-2WH	Double gang deep outlet box. Box accepts <i>PAN-WAY</i> ® Faceplates or any standard double gang faceplate. For use with <i>PAN-WAY</i> ® PMR5 or PMR7 Raceway. Breakouts for 1/2" and 1" conduit. 4.92"L x 4.92"W x 2.75"H (125.0mm x 80.5mm x 69.9mm)	White	1	10
PMR5744-3WH	Three gang deep outlet box. Box accepts <i>PAN-WAY</i> ® Faceplates or any standard three gang faceplate. For use with <i>PAN-WAY</i> ® PMR5 or PMR7 Raceway. Breakouts for 1/2" conduit. 4.92"L x 6.72"W x 2.75"H (125.0mm x 170.7mm x 69.9mm)	White	1	10
PMR5738WH	Round fixture box with solid base is c-UL-us rated to accept devices up to 50 lbs. For use with <i>PAN-WAY</i> ® PMR5 or PMR7 Raceway. Base has four 1/2" conduit breakouts. Dia. = 4.77"D x 1.00"H (121.2mm x 25.4mm)	White	1	10
PMR5738AWH	Round fan or fixture box with solid base is c-UL-us rated to accept devices up to 50 lbs. For use with <i>PAN-WAY</i> ® PMR5 or PMR7 Raceway. Base has four 1/2" conduit breakouts. Dia. = 5.53"D x 1.00"H (140.5mm x 25.4mm)	White	1	10
PMR5739WH	Round fixture box with solid base is c-UL-us rated to accept devices up to 50 lbs. For use with <i>PAN-WAY</i> ® PMR5 or PMR7 Raceway. Base has four 1/2" conduit breakouts. Dia. = 6.37"D x 1.00"H (161.8mm x 25.4mm)	White	1	10
PMR5737WH	Round extension box with open base is c-UL-us rated to accept devices up to 50 lbs. For use with <i>PAN-WAY</i> ® PMR5 or PMR7 Raceway. Dia. = 4.76"D x 1.00"H (121.0mm x 25.4mm)	White	1	10
PMR5737AWH	Round extension box with open base is c-UL-us rated to accept devices up to 50 lbs. For use with <i>PAN-WAY</i> ® PMR5 or PMR7 Raceway. Dia. = 5.53"D x 1.00"H (140.5mm x 25.4mm)	White	1	10
PMR5739AWH	Round extension box with open base is c-UL-us rated to accept devices up to 50 lbs. For use with <i>PAN-WAY</i> ® PMR5 or PMR7 Raceway. Dia. = 6.37"D x 1.00"H (161.8mm x 25.4mm)	White	1	10
PMR5752RD	Alarm device box. Box accepts alarm devices and safety signals designed to fit 4" square back boxes. For use with <i>PAN-WAY</i> ® PMR5 or PMR7 Raceway. Breakouts for 1/2" and 1" conduit. 4.92"L x 4.92"W x 1.42"H (125.0mm x 125.0mm x 36.1mm) Available in red only.	Red	1	10
PMR5753RD	Deep alarm device box. Box accepts alarm devices and safety signals designed to fit 4" square back boxes. For use with <i>PAN-WAY</i> ® PMR5 or PMR7 Raceway. Breakouts for 1/2" and 1" conduit. 4.92"L x 4.92"W x 2.80"H (125.0mm x 125.0mm x 71.0mm) Available in red only.	Red	1	10

‡For other colors replace WH (White) with AL (Almond).



PAN-WAY® Metal Raceway Faceplates



MP1GB

MP1G106

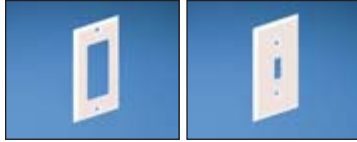

MP1GR

MP1TS



MP2GB

MP2G106



MP2GR

MP2TS



MP2G106B

MP2G106TS



MP2GRB

MP2GRTS



MP2G106R

MP3G106



MP3GR

MP3TS



MP3G1062TS

Part Number	Part Description	Color‡	Std. Pkg. Qty.	Std. Ctn. Qty.
MP1GBWH	Metal single gang blank faceplate.	White	1	10
MP1G106WH	Metal single gang 106 duplex faceplate. Covers one NEMA standard 106 duplex electrical outlet or one standard 106 communication module frame.	White	1	10
MP1GRWH	Metal single gang rectangular faceplate. Covers one NEMA standard rectangular electrical outlet or one standard rectangular communication module frame	White	1	10
MP1TSWH	Metal single gang toggle switch faceplate. Covers one NEMA standard toggle switch.	White	1	10
MP2GBWH	Metal double gang blank faceplate.	White	1	10
MP2G106WH	Metal double gang 106 duplex faceplate. Covers two NEMA standard 106 duplex electrical outlets or two standard 106 communication module frames.	White	1	10
MP2GRWH	Metal double gang rectangular faceplate. Covers two NEMA standard rectangular electrical outlets or two standard rectangular communication module frames.	White	1	10
MP2TSWH	Metal double gang toggle switch faceplate. Covers two NEMA standard toggle switch.	White	1	10
MP2G106BWH	Metal double gang 106 duplex/blank faceplate. Covers one NEMA standard 106 duplex electrical outlet or standard 106 communication module frame with opposite side blank.	White	1	10
MP2G106TSWH	Metal double gang 106 duplex/toggle switch faceplate. Covers one NEMA standard 106 duplex outlet or standard 106 communication module frame and one NEMA standard toggle switch.	White	1	10
MP2GRBWH	Metal double gang rectangular/blank faceplate. Covers one NEMA standard rectangular electrical outlet or standard rectangular communication module frame with opposite side blank.	White	1	10
MP2GRTSWH	Metal double gang rectangular/toggle switch faceplate. Covers one NEMA standard rectangular electrical outlet or standard rectangular communication module frame and one NEMA standard toggle switch.	White	1	10
MP2G106RWH	Metal double gang 106 duplex/rectangular faceplate. Covers one NEMA standard 106 duplex outlet or standard 106 communication module frame and one NEMA standard rectangular outlet or standard rectangular communication module frame.	White	1	10
MP3G106WH	Metal three gang 106 duplex faceplate. Covers three NEMA standard 106 duplex electrical outlets or three standard 106 communication module frames.	White	1	10
MP3GRWH	Metal three gang rectangular faceplate. Covers three NEMA standard rectangular electrical outlets or three standard rectangular communication module frames.	White	1	10
MP3TSWH	Metal three gang toggle switch faceplate. Covers three NEMA standard toggle switches.	White	1	10
MP3G1062TSWH	Metal three gang 106 duplex/two toggle switch faceplate. Covers one NEMA standard 106 duplex electrical outlet or one standard 106 communication module frame and two NEMA standard toggle switches.	White	1	10

‡For other colors replace WH (White) with AL (Almond).

A. System Overview

B1. Cable Ties

B2. Cable Accessories

B3. Stainless Steel Ties

C1. Wiring Duct

C2. Surface Raceway

C3. Abrasion Protection

C4. Cable Management

D1. Terminals

D2. Power Connectors

D3. Grounding Connectors

E1. Labeling Systems

E2. Labels

E3. Pre-Printed & Write-On Markers

E4. Permanent Identification

E5. Lockout/Tagout & Safety Solutions

F. Index

- A. System Overview
- B1. Cable Ties
- B2. Cable Accessories
- B3. Stainless Steel Ties
- C1. Wiring Duct
- C2. Surface Raceway
- C3. Abrasion Protection
- C4. Cable Management
- D1. Terminals
- D2. Power Connectors
- D3. Grounding Connectors
- E1. Labeling Systems
- E2. Labels
- E3. Pre-Printed & Write-On Markers
- E4. Permanent Identification
- E5. Lockout/Tagout & Safety Solutions
- F. Index

PAN-WAY® Non-Metallic Surface Raceway

PAN-WAY® Non-Metallic Surface Raceways provide maximum flexibility for routing, protecting, concealing and terminating high performance copper, voice, video, fiber optic and power cabling. PANDUIT surface raceways are designed with attention to function and aesthetics to blend with any décor. PANDUIT surface raceway systems include transition fittings that facilitate seamless integration of one PANDUIT surface raceway system to another. PANDUIT Surface Raceway Systems work with all PANDUIT® MINI-COM® Modules for complete connectivity possibilities.



- Aesthetically pleasing
- Lightweight
- Tamper resistant
- Bend radius control
- Resists dents and conceals scratches and chips
- Ease of modifications and additions
- Lowest installed cost

PANDUIT surface raceway provides a variety of choices when selecting data and electrical terminations. All PANDUIT surface raceways include a full complement of fittings that are designed to maintain the proper bend radius control required for high performance copper and fiber optic cabling systems. All of the raceways accept either NEMA 70mm standard screw-on faceplates or superior PAN-WAY® Snap-On Faceplates. PANDUIT surface raceway systems work with all PANDUIT® MINI-COM® Modules, for complete connectivity possibilities.

PAN-WAY® TG-70 Non-Metallic Surface Raceway

PAN-WAY® TG-70 Non-Metallic Surface Raceway is a multi-channel raceway, which provides a solution for routing copper, fiber optic, and/or power cabling when maximum cable capacity is required.



- Large raceway channel provides maximum capacity
- Fittings maintain 40mm (1.6 inch) bend radius control
- Multi-channel two-piece design
- Aesthetically pleasing
- Lightweight
- Tamper resistant



The TG-70 raceway system consists of raceway base and cover, fittings, termination hardware and accessories. PAN-WAY® TG-70 Raceway can mount NEMA standard screw-on faceplates or superior PAN-WAY® Snap-On Faceplates directly to the channel. Fittings for TG-70 are available to transition to PAN-WAY® T-45 and LD raceway.

A.
System
Overview

B1.
Cable Ties

B2.
Cable
Accessories

B3.
Stainless
Steel Ties

C1.
Wiring
Duct

C2.
Surface
Raceway

C3.
Abrasion
Protection

C4.
Cable
Management

D1.
Terminals

D2.
Power
Connectors

D3.
Grounding
Connectors

E1.
Labeling
Systems

E2.
Labels

E3.
Pre-Printed
& Write-On
Markers

E4.
Permanent
Identification

E5.
Lockout/
Tagout
& Safety
Solutions

F.
Index

A.
System
Overview

TG-70 Raceway Roadmap

B1.
Cable Ties

B2.
Cable
Accessories

B3.
Stainless
Steel Ties

C1.
Wiring
Duct

C2.
Surface
Raceway

C3.
Abrasion
Protection

C4.
Cable
Management

D1.
Terminals

D2.
Power
Connectors

D3.
Grounding
Connectors

E1.
Labeling
Systems

E2.
Labels

E3.
Pre-Printed
& Write-On
Markers

E4.
Permanent
Identification

E5.
Lockout/
Tagout/
& Safety
Solutions

F.
Index

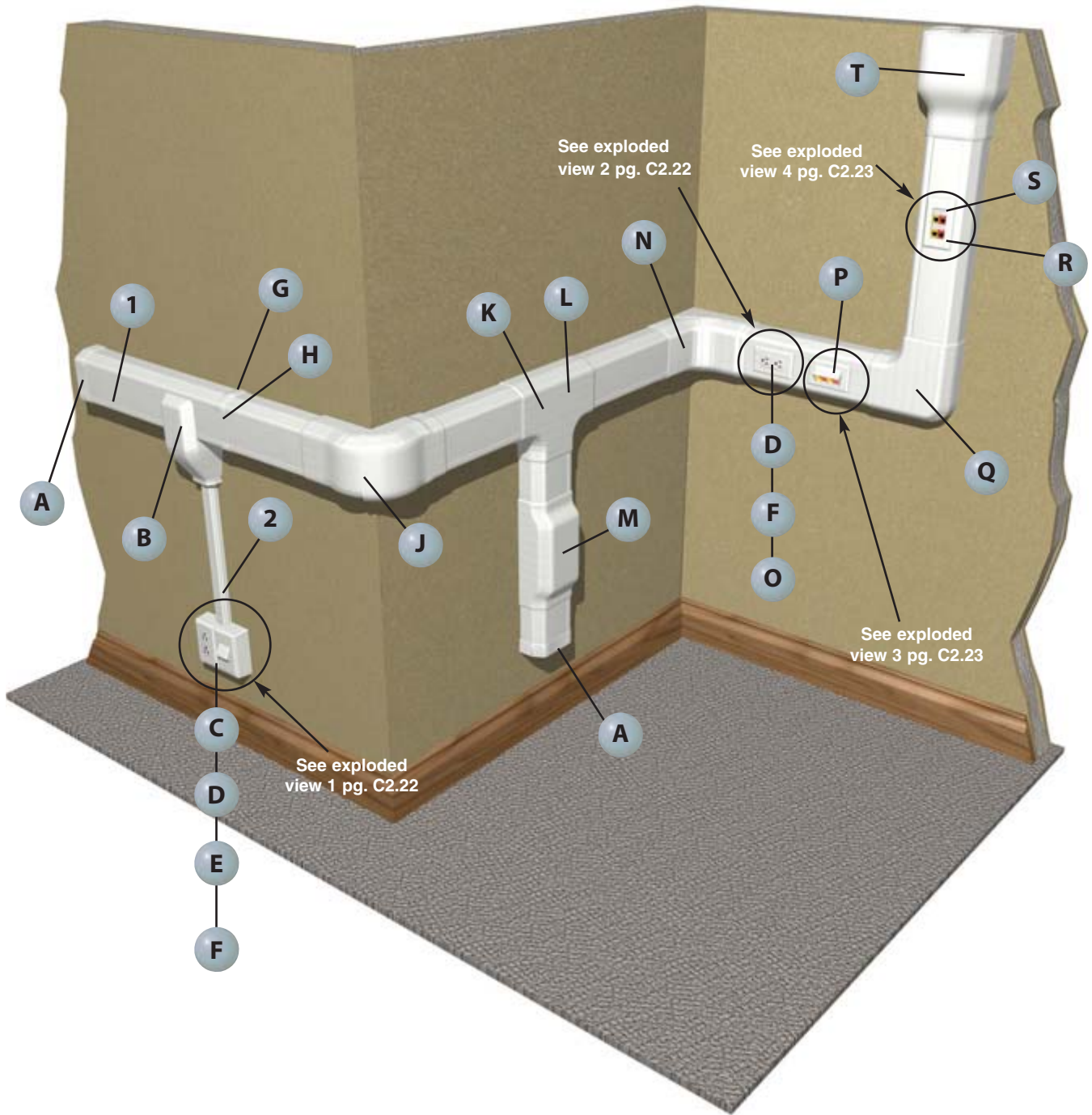

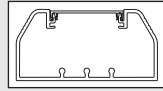

1 TG-70** – TG-70 Raceway Base and Cover (page C2.24)

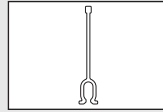

1 TGDW – TG-70 Raceway Divider Wall (page C2.24)



2 LD2P10** – Raceway (page C2.75)

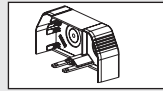

A TGEC** – TG-70 End Cap (page C2.25)

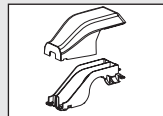

B TGTR** – TG-70 Transition Fitting (page C2.25)

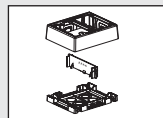

C JBP2FS** – *FAST-SNAP*™ Double Gang Power Rated Surface Mount Box (page C2.52)

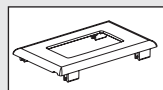

D T70PG** – Single Gang Rectangular Electrical/Communication Snap-On Faceplate (page C2.53)



E T70FV2** – Vertical Sloped Communication Snap-On Faceplate (page C2.52)

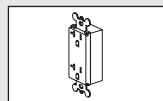

F ERU20** – 20 A Rectangular Electrical Outlet (page C2.60)

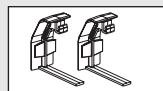

G TG70BC** – TG-70 Base Couplers (page C2.25)

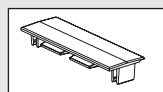

H T70CC** – T-70 Cover Couplers (page C2.25)

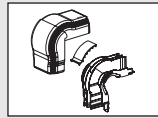

J TGOC** — TG-70 Outside Corner Fitting (page C2.25)

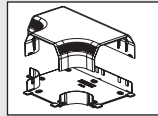

K TGT** — TG-70 Tee Fitting (page C2.25)

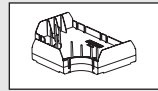

L TGTD — TG Tee Divider (page C2.25)

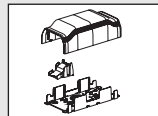

M TGBF** — TG-70 Backfeed Fitting (page C2.25)

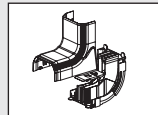

N TGIC** — TG-70 Inside Corner Fitting (page C2.25)

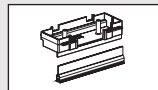

O TG70HB3-X – TG-70 Hanging Box with Divider Wall (page C2.26)

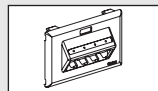

P UIT70FH4** – *ULTIMATE ID*® Sloped Horizontal Snap-On Faceplate

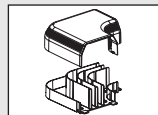

Q TGRA** – TG-70 Right Angle Fitting (page C2.25)

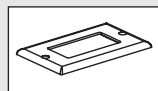

R CPG** – Single Gang Rectangular Power and Communication Faceplate (page C2.59)

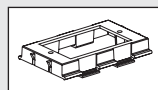

S T70DB-X – T-70 Device Bracket (page C2.26)

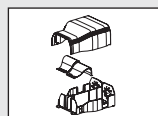

T TGEE** – TG-70 Entrance End Fitting (page C2.25)

A. System Overview

B1. Cable Ties

B2. Cable Accessories

B3. Stainless Steel Ties

C1. Wiring Duct

C2. Surface Raceway

C3. Abrasion Protection

C4. Cable Management

D1. Terminals

D2. Power Connectors

D3. Grounding Connectors

E1. Labeling Systems

E2. Labels

E3. Pre-Printed & Write-On Markers

E4. Permanent Identification

E5. Lockout/Tagout & Safety Solutions

F. Index

A.
System
Overview

TG-70 Configurations

B1.
Cable Ties

Exploded View 1

	Components Required	See page
A.	T70FV2 = Vertical sloped communication snap-on faceplate.	C2.52
B.	PANDUIT® MINI-COM® Modules.	—
C.	T70PG = Single gang rectangular electrical/communication snap-on faceplate.	C2.53
D.	ERU20 = 20 A rectangular electrical outlet (screws included).	C2.60
E.	JBP2FS = FAST-SNAP™ Double Gang Power Rated Surface Mount Outlet Box.	C2.52

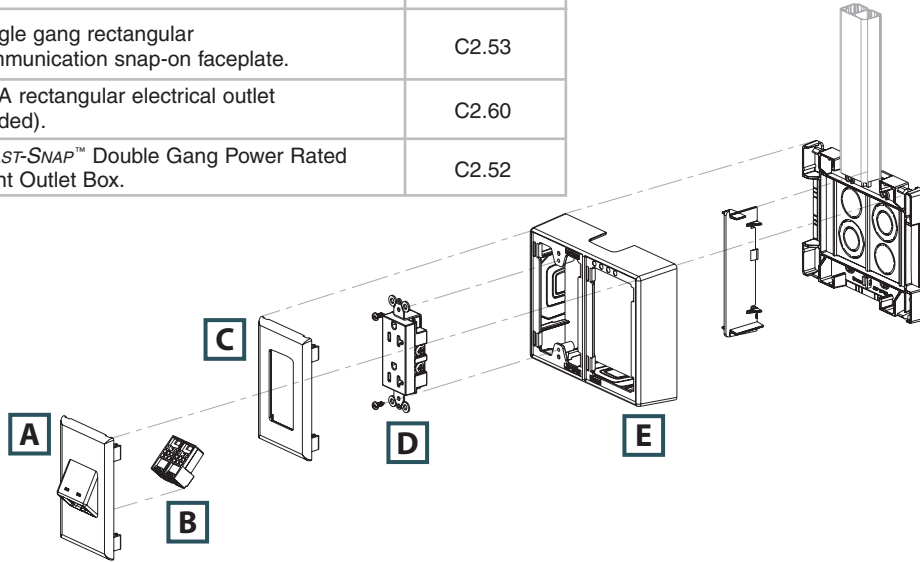

D1.
Terminals

Exploded View 2

	Components Required	See page
A.	T70PG = Single gang rectangular electrical/communication snap-on faceplate.	C2.53
B.	ERU20 = 20 A rectangular electrical outlet (screws included).	C2.60
C.	TG70HB3 = TG-70 3-sided hanging box.	C2.26

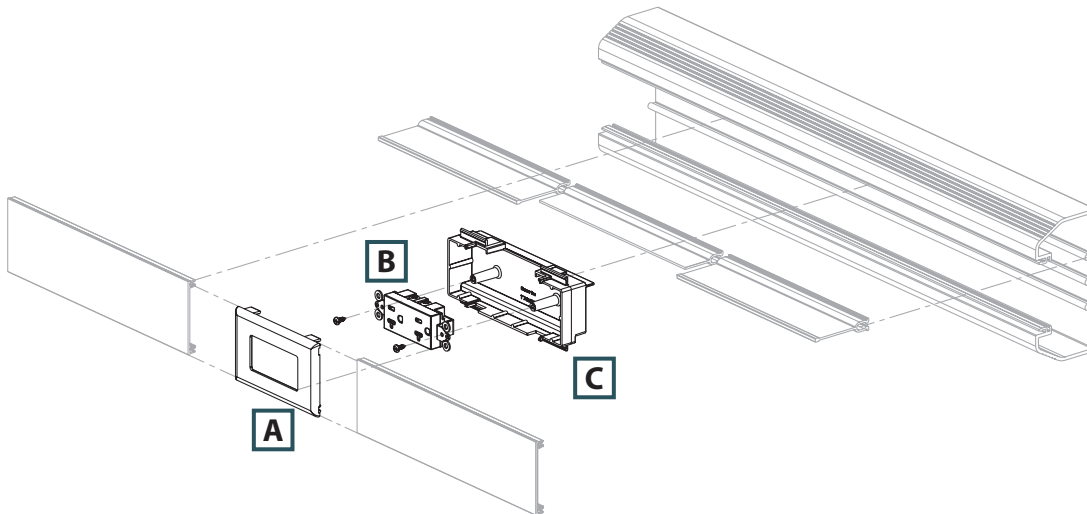

E1.
Labeling
Systems

E2.
Labels

E3.
Pre-Printed
& Write-On
Markers

E4.
Permanent
Identification

E5.
Lockout/
Tagout/
& Safety
Solutions

F.
Index

TG-70 Configurations (continued)

Exploded View 3

	Components Required	See page
A.	UIT70FH4 = <i>ULTIMATE ID</i> ® Sloped Horizontal Snap-On Faceplate – 4-port.	—
B.	<i>MINI-COM</i> ® Modules.	—

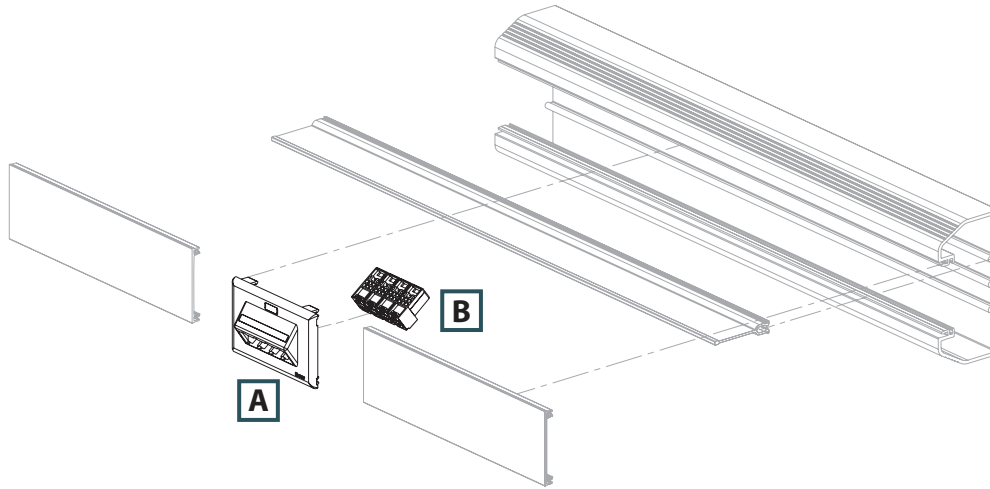

Exploded View 4

	Components Required	See page
A.	CPG = Single gang rectangular screw-on faceplate (screws included).	C2.59
B.	CFG4 = <i>MINI-COM</i> ® Module Frame – 4-port.	—
C.	<i>MINI-COM</i> ® Modules.	—
D.	T70DB-X = T70 device bracket.	C2.26

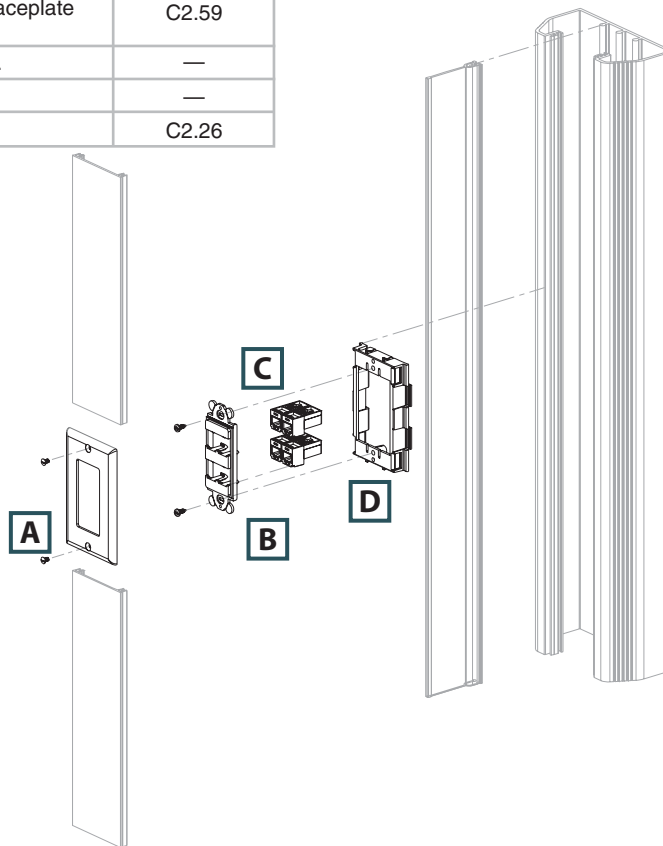

A.
System
Overview

B1.
Cable Ties

B2.
Cable
Accessories

B3.
Stainless
Steel Ties

C1.
Wiring
Duct

C2.
Surface
Raceway

C3.
Abrasion
Protection

C4.
Cable
Management

D1.
Terminals

D2.
Power
Connectors

D3.
Grounding
Connectors

E1.
Labeling
Systems

E2.
Labels

E3.
Pre-Printed
& Write-On
Markers

E4.
Permanent
Identification

E5.
Lockout/
Tagout
& Safety
Solutions

F.
Index

A.
System
Overview

UL **SF** **PAN-WAY® TG-70 Surface Raceway System**
SA LISTED

B1.
Cable Ties

- UL and CSA rated 600 V; meets UL 5A and CSA C22.2 No. 62.1-03 standards; FT4 rated
- Large cable capacity with aesthetically pleasing design
- Tamper resistant

- Compatible with NEMA standard faceplates or *PAN-WAY®* Classic Series Snap-On Faceplates
- Transitions to *PANDUIT* T-45 and LD profile raceway
- Supplied with pre-punched mounting holes

B2.
Cable
Accessories

B3.
Stainless
Steel Ties

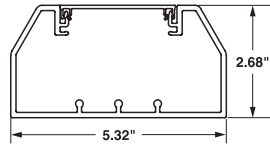

TG-70
Internal Area = 10.85 Sq. In.

C1.
Wiring
Duct



TG70

Part Number	Part Description	Raceway Size	Color‡	Length (Ft.)	Std. Ctn. Qty.
TG-70 Raceway Base and Cover — PACKAGED TOGETHER					
TG70IW8	TG-70 raceway base in 8' and 10' lengths. Supplied with pre-punched mounting holes.	5.32" x 2.68" (135.0mm x 68.0mm)	Off White	8	32
TG70IW10				10	40

C2.
Surface
Raceway

C3.
Abrasion
Protection



T70C

T-70/TG-70/Twin-70 Raceway Cover					
T70CIW8	T-70, TG-70, or Twin-70 raceway cover in 8' and 10' lengths.	—	Off White	8	96
T70CIW10				10	120

C4.
Cable
Management



TGDW

TG Raceway Divider Wall					
TGDW8	TG raceway divider wall. Snaps onto rails in TG raceway base to create separate channels. Must use wire retainers to ensure channel separation per UL/CSA. Available in 8' and 10' lengths.	—	Gray	8	64
TGDW10				10	80

‡For other colors replace IW (Off White) with EI (Electric Ivory).
Order number of feet required in multiples of standard carton quantity.

D1.
Terminals

D2.
Power
Connectors

D3.
Grounding
Connectors

E1.
Labeling
Systems

E2.
Labels

E3.
Pre-Printed
& Write-On
Markers

E4.
Permanent
Identification

E5.
Lockout/
Tagout
& Safety
Solutions

F.
Index

UL **SP** **PAN-WAY® TG-70 Raceway Fittings**

• TG-70 fittings are designed to exceed the TIA/EIA-568-B and 569-B required minimum bend radius for high performance copper and fiber optic cabling systems



Part Number	Part Description	Color‡	Std. Pkg. Qty.	Std. Ctn. Qty.
T70CCIW-X	Cover coupler fitting. Used to join sections of cover together.	Off White	10	100
TG70BCIW-X	Base coupler fitting. Each piece includes two base coupler halves for joining sections of TG-70 base together.	Off White	10	—
TGRAIW	Right angle fitting. Used to join sections of TG raceway at 90° flat junctions.	Off White	1	10
TGICIW	Inside corner fitting. Used to join sections of TG raceway at inside corners. Fittings adjust from 85° to 135° to adapt to non-square corners.	Off White	1	—
TGSICIW	Inside corner fitting – non-adjustable. Used to join sections of TG raceway at inside corners.	Off White	1	10
TGOCIW	Outside corner fitting. Used to join sections of TG raceway at outside corners. Fittings adjust from 85° to 135° to adapt to non-square corners.	Off White	1	—
TGSOCIW	Outside corner fitting – non-adjustable. Used to join sections of TG raceway at inside corners.	Off White	1	10
TGTIW	Tee fitting. Used to join sections of TG raceway at tee intersections.	Off White	1	5
TGTD	Tee divider insert. Mounts inside TGT tee fitting to maintain channel separation in TG raceway at tee intersections.	Gray	1	5
TGECIW	End cap. Used to terminate or allow entry to TG raceway. Two knockouts each for .50" (12.7mm) and 1" (25.4mm) conduit.	Off White	1	10
TGEEIW	Entrance end fitting. Accepts large conduit, (up to 2") in line <i>or</i> at a right angle. Maintains a 40mm bend radius with a removable insert and channel separation.	Off White	1	10
TGTRIW	Transition fitting from TG to T-45. Provides a tee transition from TG raceway to T-45 and LD series size 5 and 10. Use with RF5X3 reducer fitting to transition to LD series size 3.	Off White	1	10
TGBFIW	Backfeed fitting. Features breakouts to enter through the bottom of the fitting and maintains bend radius control with a removable, bend radius insert and channel separation.	Off White	1	10
TGBFI	Backfeed fitting insert. Removable and maintains bend radius control.	Off White	1	10

‡For other colors replace IW (Off White) with EI (Electric Ivory).

A. System Overview

B1. Cable Ties

B2. Cable Accessories

B3. Stainless Steel Ties

C1. Wiring Duct

C2. Surface Raceway

C3. Abrasion Protection

C4. Cable Management

D1. Terminals

D2. Power Connectors

D3. Grounding Connectors

E1. Labeling Systems

E2. Labels

E3. Pre-Printed & Write-On Markers

E4. Permanent Identification

E5. Lockout/Tagout & Safety Solutions

F. Index

A. System Overview



PAN-WAY® TG-70 Raceway Accessories

B1. Cable Ties

- TG-70 accessories consist of device mounting brackets, standard faceplate brackets for data, wire retainers and fiber spool brackets; the three-sided hanging box is used to mount NEMA standard single gang outlet and communications devices

B2. Cable Accessories

B3. Stainless Steel Ties

C1. Wiring Duct

C2. Surface Raceway

C3. Abrasion Protection

C4. Cable Management

D1. Terminals

D2. Power Connectors

D3. Grounding Connectors

E1. Labeling Systems

E2. Labels

E3. Pre-Printed & Write-On Markers

E4. Permanent Identification

E5. Lockout/Tagout & Safety Solutions

F. Index

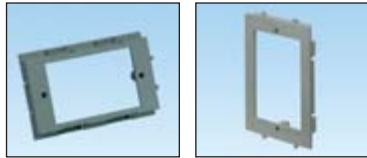

T70DB-X

T70SDB-X

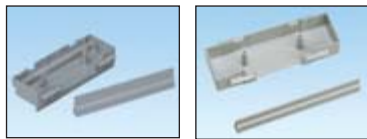

TG70HB3-X

TG70HB3GFCI-X



TG70WR-X

TGFSB

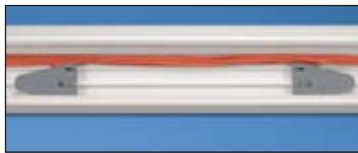

TGFSB installed in TG-70 raceway

Part Number	Part Description	Color	Std. Pkg. Qty.	Std. Ctn. Qty.
T70DB-X	Device mounting bracket. Used to mount NEMA standard single gang electrical outlets and communication devices with either screw-on or snap-on single gang faceplates. Can be used with T-70, Twin-70, and TG-70 raceway.	Gray	10	—
T70SDB-X	Standard faceplate bracket. Used to mount NEMA standard 70mm single gang screw-on faceplates. Can be used with T-70, Twin-70, TG-70 raceway and PAN-POLE™ Communication Pole.	Gray	10	—
TG70HB3-X	3-sided hanging box. Mounts standard electrical outlets or communication devices with either NEMA standard single gang screw-on or PANDUIT snap-on faceplates. When used with TGDW divider wall, box separates and fully encloses device to provide cabling separation.	Gray	10	—
TG70HB3GFCI-X	GFCI 3-sided hanging box. Accepts single gang U.S. GFCI (ground fault circuit interrupter) standard electrical devices. Provides increased internal area for connections and excess wire.	Gray	10	—
TG70WR-X	Wire retainer. Holds wires in place during installation.	Gray	10	100
TGFSB	Fiber spool bracket. Each piece consists of two halves that snap into base of TG raceway. Provides method to contain one meter or more of fiber slack and acts as a strain relief while maintaining a minimum 32mm bend radius. Bracket separation can be adjusted to fit the length of slack required.	Gray	1	10

Cable Fill Capacities for TG-70 Raceway

This information is to be used as a guide in selecting the proper size raceway. The maximum amounts may vary according to the cable installation methods, straightness of cables, etc.

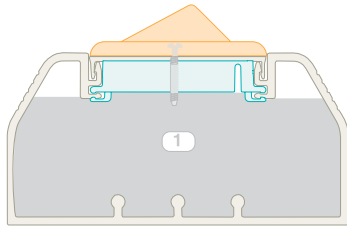

A = 10.09 in.²

Cable fill #1: With data only using screw-on faceplates and devices.

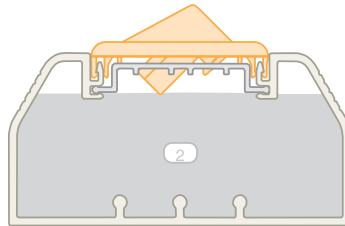

A = 10.68 in.²

Cable fill #2: With data only using snap-on faceplates and wire retainer.

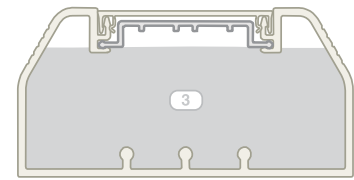

A = 10.85 in.²

Cable fill #3: With wire retainer.

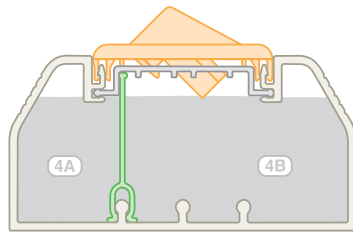

A = 3.16 in.²

A = 7.20 in.²

Cable fill #4: Divided (see 5A and 5B for power and data applications).

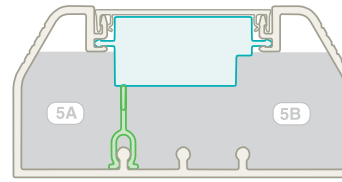

A = 3.08 in.²

A = 5.58 in.²

Cable fill #5: With Power and data using snap-on faceplates and 3-sided power box.

Raceway Type and Configuration	Fill Area (In. ²)	Electrical Cables			Data Grade Cables		Data Grade Cables		Audio/Video		Fiber Optic Cable	
		14 AWG	12 AWG	10 AWG	24 AWG/UTP CM		24 AWG/UTP CM		RG6		2 Strand	
		THHN/T90			Cat. 6		Cat. 6A					
		0.111	0.130	0.164	DIA. = 0.250		DIA. = 0.330		DIA. = 0.275		DIA. = 0.175	
		FILL			FILL		FILL		FILL		FILL	
		MAX	MAX	MAX	SPEC	MAX	SPEC	MAX	SPEC	MAX	SPEC	MAX
(UL Temp Rise Test)			(40%)	(60%)	(40%)	(60%)	(40%)	(60%)	(40%)	(60%)	(40%)	(60%)
1. TG70: Data only using screw-on faceplates and devices.	10.09	—	—	—	82	123	47	70	67	101	167	251
2. TG70: Data only using snap-on faceplates and wire retainer.	10.68	—	—	—	87	130	49	74	71	107	177	266
3. TG70: Wire retainer without devices.	10.85	40	40	38	88	132	50	76	73	109	180	270
4A. TG70: Divided power and data (A).	3.16	28	28	26	—	—	—	—	—	—	—	—
4B. TG70: Divided power and data (B).	7.2	—	—	—	58	88	33	50	48	72	119	179
5A. TG70: Power and data using snap-on faceplates and 3-sided power box (A).	3.08	28	28	26	—	—	—	—	—	—	—	—
5B. TG70: Power and data using snap-on faceplates and 3-sided power box (B).	5.58	—	—	—	45	68	26	39	37	56	92	139

AWG dimensions represent typical outer cable diameter in inches.

A.
System
Overview

B1.
Cable Ties

B2.
Cable
Accessories

B3.
Stainless
Steel Ties

C1.
Wiring
Duct

C2.
Surface
Raceway

C3.
Abrasion
Protection

C4.
Cable
Management

D1.
Terminals

D2.
Power
Connectors

D3.
Grounding
Connectors

E1.
Labeling
Systems

E2.
Labels

E3.
Pre-Printed
& Write-On
Markers

E4.
Permanent
Identification

E5.
Lockout/
Tagout/
& Safety
Solutions

F.
Index

NOTES

PAN-WAY® T-70 AND TWIN-70 NON-METALLIC SURFACE RACEWAY

PAN-WAY® T-70 and Twin-70 Non-Metallic Surface Raceways are multi-channel raceways which provide solutions for routing copper, fiber optic, and/or power cabling along fixed perimeter walls. T-70 features the *WORKSTATION OUTLET CENTER™* Offset Box which provides an offset solution to maximize channel capacity and outlet density. Twin-70 offers two totally independent channels maintained throughout the system for independent access to power, copper, and fiber optic cabling.



- Aesthetically pleasing
- Lightweight
- Tamper resistant
- Fittings maintain 1 inch bend radius control
- T-70 utilizes a single channel with snap-in divider wall to provide multi-channel capability
- Twin-70 utilizes two independent channels and covers to provide multi-channel capability

The T-70 and Twin-70 raceway systems consist of raceway base and cover, fittings, termination hardware and accessories. PAN-WAY® T-70 and Twin-70 Raceway can mount NEMA standard screw-on faceplates or superior PAN-WAY® Snap-On Faceplates directly to the channel. Fittings for T-70 and Twin-70 are available to transition to T-70, Twin-70, T-45 and LD raceways.

A.
System
Overview

B1.
Cable Ties

B2.
Cable
Accessories

B3.
Stainless
Steel Ties

C1.
Wiring
Duct

C2.
Surface
Raceway

C3.
Abrasion
Protection

C4.
Cable
Management

D1.
Terminals

D2.
Power
Connectors

D3.
Grounding
Connectors

E1.
Labeling
Systems

E2.
Labels

E3.
Pre-Printed
& Write-On
Markers

E4.
Permanent
Identification

E5.
Lockout/
Tagout
& Safety
Solutions

F.
Index

A.
System
Overview

T-70 Raceway Roadmap

B1.
Cable Ties

B2.
Cable
Accessories

B3.
Stainless
Steel Ties

C1.
Wiring
Duct

C2.
Surface
Raceway

C3.
Abrasion
Protection

C4.
Cable
Management

D1.
Terminals

D2.
Power
Connectors

D3.
Grounding
Connectors

E1.
Labeling
Systems

E2.
Labels

E3.
Pre-Printed
& Write-On
Markers

E4.
Permanent
Identification

E5.
Lockout/
Tagout/
& Safety
Solutions

F.
Index

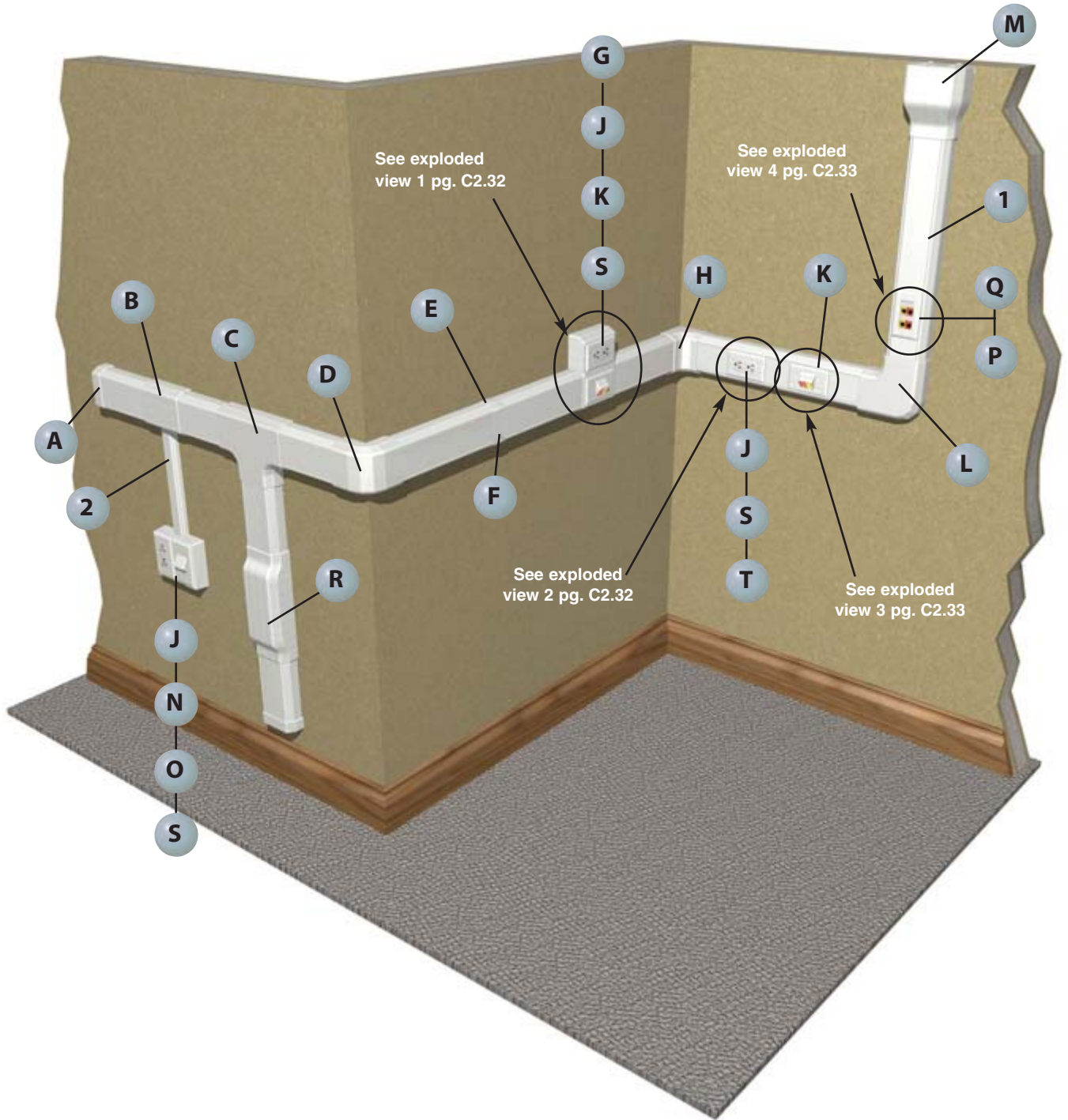

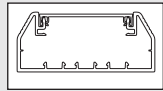

1 T70B** , T70C** – T-70 Base and Cover (page C2.36)

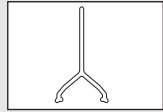

1 T70DW – T-70 Divider Wall (page C2.36)

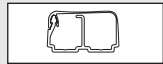

2 LD2P10** – LD2P10 Raceway (page C2.75)

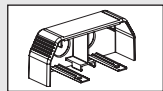

A T70EC** – T-70 End Cap Fitting (page C2.37)

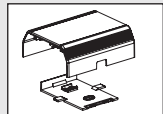

B T70TR** – T-70 Transition Fitting (page C2.37)

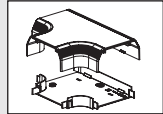

C T70T** – T-70 Tee Fitting
T70TD – T-70 Tee Divider (page C2.37)

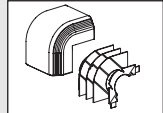
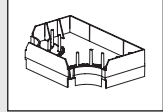

D T70OC** – T-70 Outside Corner Fitting (page C2.37)

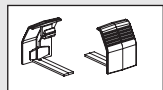

E T70BC** – T-70 Base Coupler Fitting (page C2.36)

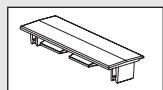

F T70CC** – T-70 Cover Coupler Fitting (page C2.36)

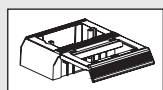

G T70WC2** – T-70 WORKSTATION OUTLET CENTER™ Offset Box for Snap-On Faceplates (page C2.37)

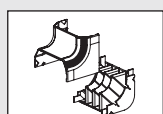

H T70IC** – T-70 Inside Corner Fitting (page C2.37)

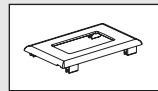

J T70PG** – Single Gang Rectangular Electrical/Communication Snap-On Faceplate (page C2.53)

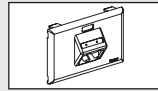

K UIT70FH2** – ULTIMATE ID® Sloped Horizontal Snap-On Faceplate

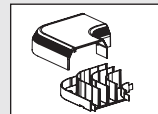

L T70RA** – T-70 Right Angle Fitting (page C2.36)

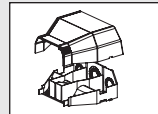

M T70EE** – T-70 Entrance End Fitting (page C2.37)

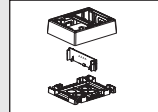

N JBP2FS** – FAST-SNAP™ Double Gang Power Rated Surface Mount Outlet Box (page C2.52)



O T70FV2** – Vertical Sloped Communication Snap-On Faceplate (page C2.52)

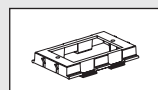

P T70DB-X – T-70 Device Bracket (page C2.40)

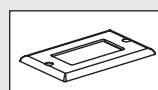

Q CPG** – Single Gang Rectangular Screw-On Faceplate (page C2.59)

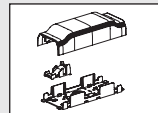

R T70BF** – T-70 Backfeed Fitting (page C2.37)

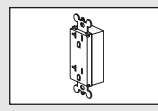

S ERU20** – 20 A Rectangular Electrical Outlet (page C2.60)

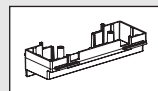

T T70HB3-X – 3-Sided Hanging Box (page C2.40)

A. System Overview

B1. Cable Ties

B2. Cable Accessories

B3. Stainless Steel Ties

C1. Wiring Duct

C2. Surface Raceway

C3. Abrasion Protection

C4. Cable Management

D1. Terminals

D2. Power Connectors

D3. Grounding Connectors

E1. Labeling Systems

E2. Labels

E3. Pre-Printed & Write-On Markers

E4. Permanent Identification

E5. Lockout/Tagout & Safety Solutions

F. Index

A.
System
Overview

T-70 Configurations

B1.
Cable Ties

Exploded View 1

B2.
Cable
Accessories

B3.
Stainless
Steel Ties

C1.
Wiring
Duct

C2.
Surface
Raceway

C3.
Abrasion
Protection

C4.
Cable
Management

D1.
Terminals

D2.
Power
Connectors

D3.
Grounding
Connectors

E1.
Labeling
Systems

E2.
Labels

E3.
Pre-Printed
& Write-On
Markers

E4.
Permanent
Identification

E5.
Lockout/
Tagout/
& Safety
Solutions

F.
Index

	Components Required	See page
A.	T70WC2 = T-70 <i>WORKSTATION OUTLET CENTER™</i> Offset Box for snap-on faceplates.	C2.37
B.	ERU20 = 20 A rectangular electrical outlet (screws included).	C2.60
C.	MINI-COM® Modules.	—
D.	T70PG = Single gang rectangular electrical/communication snap-on faceplate.	C2.53
E.	UIT70FH2 = <i>ULTIMATE ID®</i> Sloped Horizontal Snap-On Faceplate – 2-port.	—

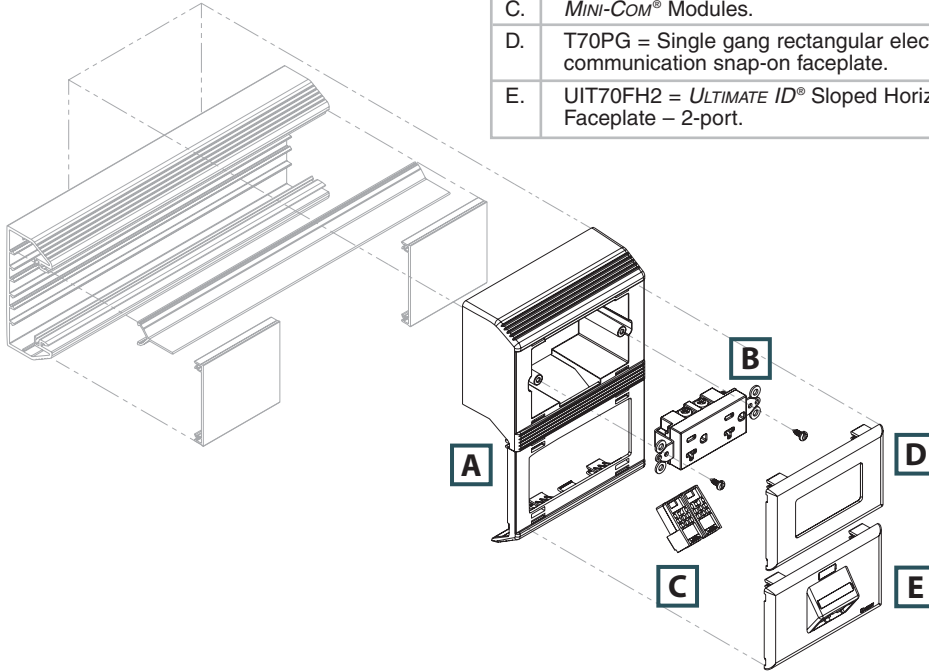

Exploded View 2

	Components Required	See page
A.	T70PG = Single gang rectangular electrical/communication snap-on faceplate.	C2.53
B.	ERU20 = 20 A rectangular electrical outlet (screws included).	C2.60
C.	T70HB3-X = 3-Sided hanging box.	C2.40

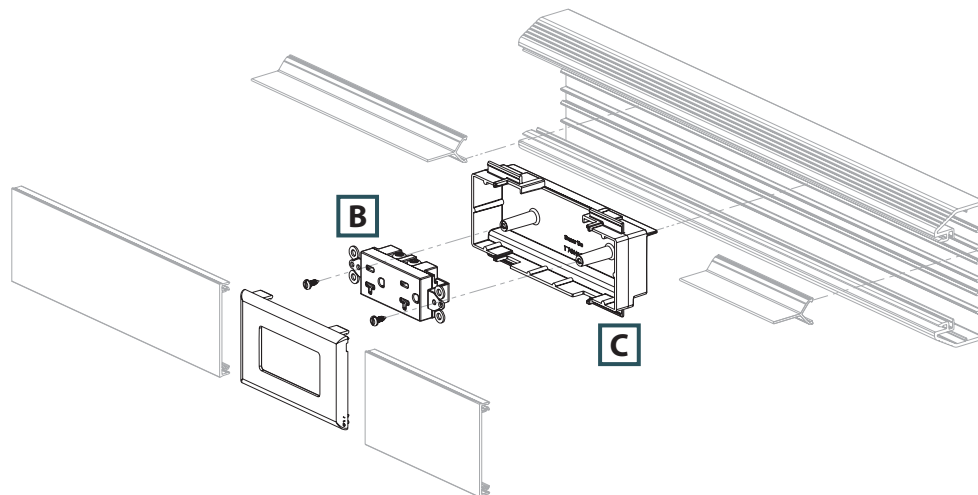

T-70 Configurations (continued)

Exploded View 3

	Components Required	See page
A.	UIT70FH2 = <i>ULTIMATE ID</i> ® Sloped Horizontal Snap-On Faceplate – 2-port.	—
B.	<i>MINI-COM</i> ® Modules.	—

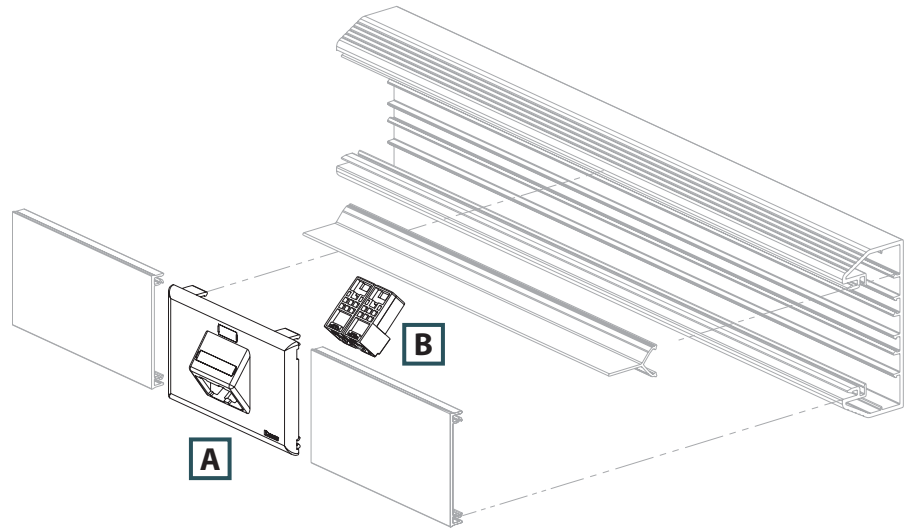

Exploded View 4

	Components Required	See page
A.	CPG = Single gang rectangular screw-on faceplates (screws included).	C2.59
B.	CFP4 = <i>MINI-COM</i> ® Module Frame – 4-port.	—
C.	<i>MINI-COM</i> ® Modules.	—
D.	T70DB-X = T-70 device bracket.	C2.40

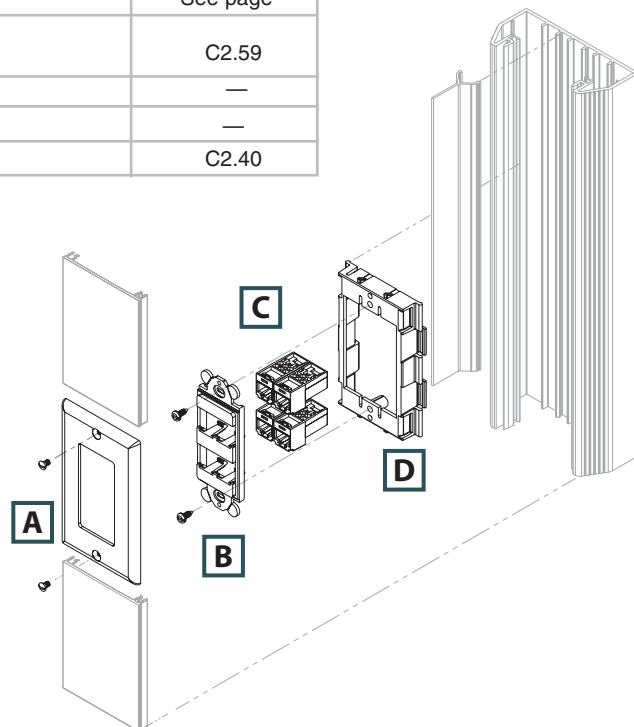

A.
System
Overview

B1.
Cable Ties

B2.
Cable
Accessories

B3.
Stainless
Steel Ties

C1.
Wiring
Duct

C2.
Surface
Raceway

C3.
Abrasion
Protection

C4.
Cable
Management

D1.
Terminals

D2.
Power
Connectors

D3.
Grounding
Connectors

E1.
Labeling
Systems

E2.
Labels

E3.
Pre-Printed
& Write-On
Markers

E4.
Permanent
Identification

E5.
Lockout/
Tagout/
& Safety
Solutions

F.
Index

A.
System
Overview

Twin-70 Raceway Roadmap

B1.
Cable Ties

B2.
Cable
Accessories

B3.
Stainless
Steel Ties

C1.
Wiring
Duct

C2.
Surface
Raceway

C3.
Abrasion
Protection

C4.
Cable
Management

D1.
Terminals

D2.
Power
Connectors

D3.
Grounding
Connectors

E1.
Labeling
Systems

E2.
Labels

E3.
Pre-Printed
& Write-On
Markers

E4.
Permanent
Identification

E5.
Lockout/
Tagout/
& Safety
Solutions

F.
Index

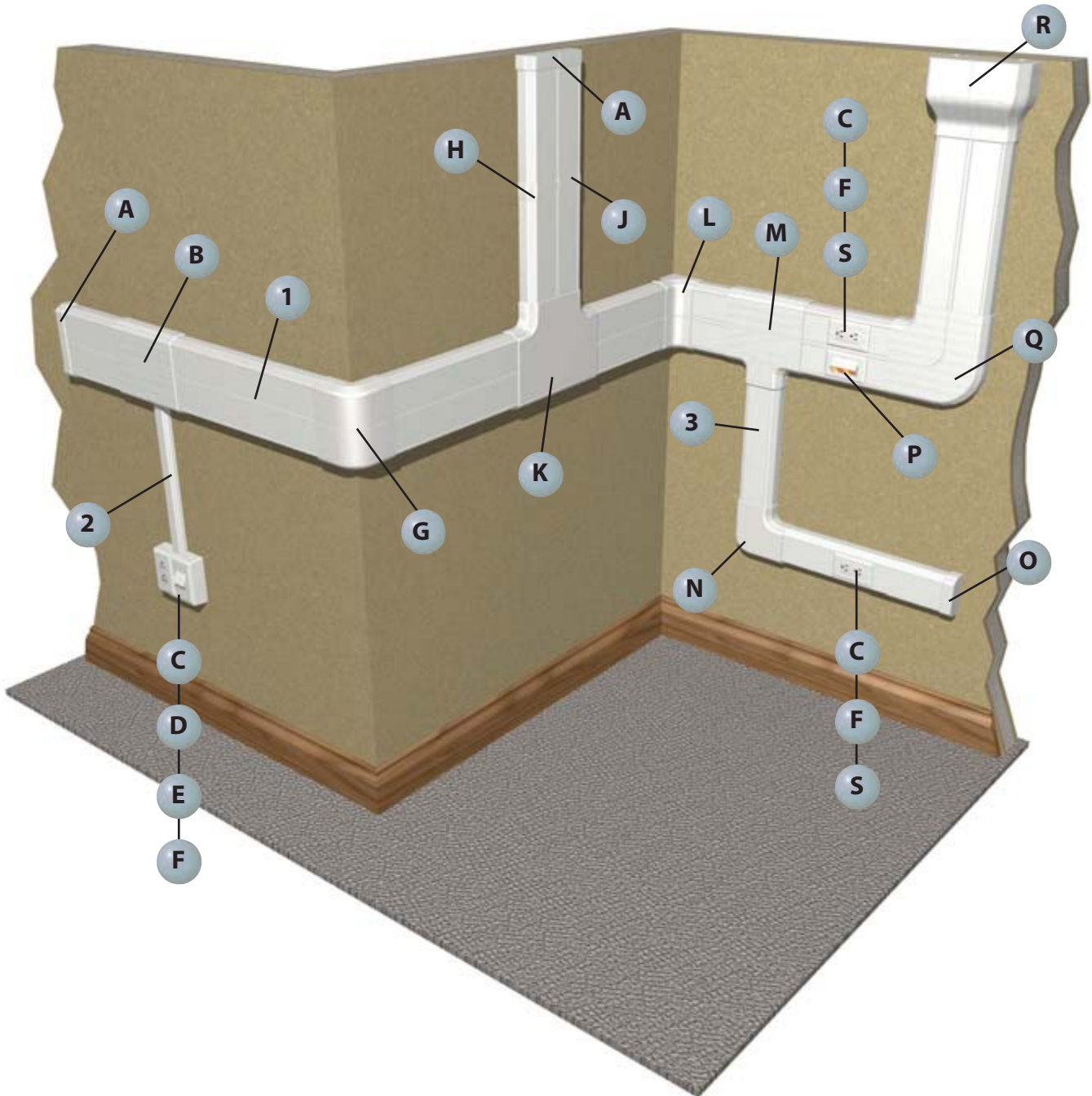

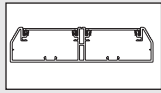

1 T702B**, T70C** – T702 Raceway Base and Cover (page C2.38)

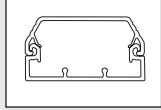

2 T45B**, T45C** – T-45 Raceway Base and Cover (page C2.48)

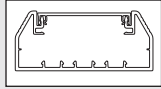

3 T70B**, T70C** – T-70 Raceway Base and Cover (page C2.36)

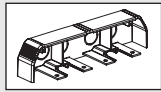

A T702EC** – Twin-70 End Cap Fitting (page C2.39)

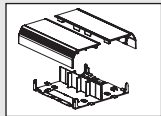

B T702TRL** – Twin-70 Transition Fitting (page C2.39)

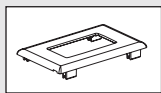

C T70PG** – Single Gang Rectangular Electrical/Communication Snap-On Faceplate (page C2.53)



D T70FV2** – Vertical Sloped Communication Snap-On Faceplate (page C2.52)

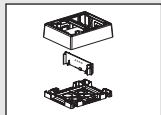

E JBP2FS** – FAST-SNAP™ Double Gang Power Rated Surface Mount Outlet Box (page C2.52)

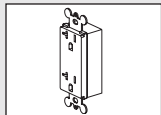

F ERU20** – 20 A Rectangular Electrical Outlet (page C2.60)

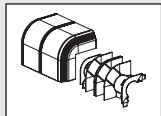

G T702OC** – Twin-70 Outside Corner Fitting (page C2.39)

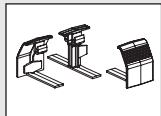

H T702BC** – Twin-70 Base Coupler Fitting (page C2.39)

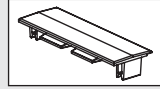

J T70CC** – T-70 Cover Coupler Fitting (page C2.39)

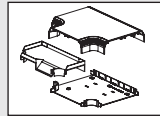

K T702T** – Twin-70 Tee Fitting (page C2.39)

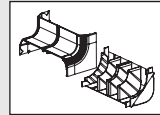

L T702IC** – Twin-70 Inside Corner Fitting (page C2.39)

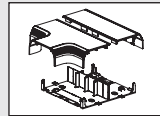

M T702TR** – Twin-70 Transition Fitting (page C2.39)

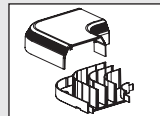

N T70RA** – T-70 Right Angle Fitting (page C2.39)

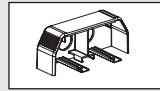

O T70EC** – T-70 End Cap Fitting (page C2.37)

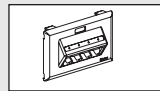

P UIT70FH4** – ULTIMATE ID® Sloped Horizontal Snap-On Faceplate

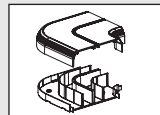

Q T702RA** – Twin-70 Right Angle Fitting (page C2.39)

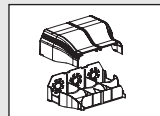

R T702EE** – Twin-70 Entrance End Fitting (page C2.39)

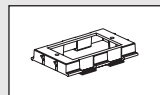

S T70DB-X** – T-70 Device Mounting Bracket (page C2.40)

A. System Overview

B1. Cable Ties

B2. Cable Accessories

B3. Stainless Steel Ties

C1. Wiring Duct

C2. Surface Raceway

C3. Abrasion Protection

C4. Cable Management

D1. Terminals

D2. Power Connectors

D3. Grounding Connectors

E1. Labeling Systems

E2. Labels

E3. Pre-Printed & Write-On Markers

E4. Permanent Identification

E5. Lockout/Tagout & Safety Solutions

F. Index

A. System Overview



PAN-WAY® T-70 Surface Raceway System

B1. Cable Ties

- UL and CSA rated 600 V; meets UL 5A and CSA C22.2 No. 62.1-03 standards; FT4 rated
- Large cable capacity with aesthetically pleasing design
- Tamper resistant

- Compatible with NEMA standard 70mm faceplates or PAN-WAY® Classic Series Snap-On Faceplates
- Transitions to PANDUIT T-45 and LD profile raceway
- Supplied with pre-punched mounting holes

B2. Cable Accessories

B3. Stainless Steel Ties

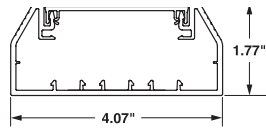

T-70
Internal Area = 5.15 Sq. In.



T70B



T70C

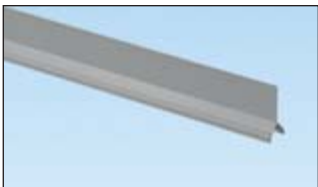

T70DW

Part Number	Part Description	Raceway Size	Color‡	Length (Ft.)	Std. Ctn. Qty.
-------------	------------------	--------------	--------	--------------	----------------

T-70 Raceway Base

T70BIW8	T-70 raceway base in 8' and 10' lengths. Supplied with pre-punched mounting holes.	4.07" x 1.77" (103.3mm x 45.0mm)	Off White	8	48
T70BIW10				10	60

T-70/TG-70/Twin-70 Raceway Cover

T70CIW8	T-70, TG-70, or Twin-70 raceway cover in 8' and 10' lengths.	—	Off White	8	96
T70CIW10				10	120

T-70/Twin-70 Raceway Divider Wall

T70DW8	T-70/Twin-70 raceway divider wall. Snaps onto rails in T-70/Twin-70 raceway base to create separate channels. Must use wire retainers to ensure channel separation per UL/CSA. Available in 8' and 10' lengths.	—	Gray	8	96
T70DW10				10	120

‡For other colors replace IW (Off White) with EI (Electric Ivory), WH (White), or IG (International Gray in 8' lengths ONLY). Order raceway base and cover separately.
Order number of feet required in multiples of standard carton quantity.

D1. Terminals

D2. Power Connectors

D3. Grounding Connectors



PAN-WAY® T-70 Raceway Fittings

E1. Labeling Systems

- T-70 fittings are designed to maintain the TIA/EIA-568-B and 569-B required minimum bend radius for high performance copper and fiber optic cabling systems

E2. Labels



T70CC



T70BC

E3. Pre-Printed & Write-On Markers

E4. Permanent Identification



T70RA



T70IC

E5. Lockout/Tagout & Safety Solutions

F. Index

Part Number	Part Description	Color‡	Std. Pkg. Qty.	Std. Ctn. Qty.
T70CCIW-X	Cover coupler fitting. Used to join sections of cover together.	Off White	10	100
T70BCIW-X	Base coupler fitting. Used to join sections of T-70 raceway base together.	Off White	10	0
T70RAIW	Right angle fitting. Used to join sections of T-70 raceway at right angles.	Off White	1	10
T70ICIW	Inside corner fitting. Used to join sections of T-70 raceway at inside corners.	Off White	1	10

‡For other colors replace IW (Off White) with EI (Electric Ivory), IG (International Gray), or WH (White).

 **PAN-WAY® T-70 Raceway Fittings (continued)**



T70OC

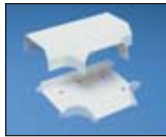

T70T



T70TD



T70EC



T70EE



**T70TR
T70TRC**



T70TRI



T70WM40TR



T70BF



T70BFI



T70WC



T70WC2

Part Number	Part Description	Color‡	Std. Pkg. Qty.	Std. Ctn. Qty.
T70OCIW	Outside corner fitting. Used to join sections of T-70 raceway at outside corners.	Off White	1	10
T70TIW	Tee fitting. Used to join sections of T-70 raceway at tee intersections.	Off White	1	10
T70TD	T-70 tee fitting divider. Separates power and data within tee fitting. Replaces T70TDB, T70TDC, and T70TDT.	Gray	1	10
T70ECIW	End cap fitting. Used to terminate or allow entry to T-70 raceway with conduit breakouts of 1/2".	Off White	1	10
T70EEIW	Entrance end fitting. Conduit breakouts of 1/2", 3/4", 1" and 1 1/4" which allows entry from ceiling or wall.	Off White	1	10
T70TRIW	Transition fitting. Used to transition to any LD profile or T-45 raceway while maintaining channel separation. Fitting includes bend radius insert.	Off White	1	10
T70TRCIW	Transition fitting cover. Used to transition to any LD profile or T-45 raceway.	Off White	1	10
T70TRI	Divided insert for T-70 to LD2P10. Maintains channel separation within T70TR fitting.	Gray	1	10
T70WM40TRIW	WIREMOLD* 4000 to T-70 transition fitting. In-line transition fitting from WIREMOLD* 4000 to T-70 raceway.	Off White	1	10
T70BFIW	Backfeed fitting. Allows cable entry through the back of the T-70 raceway	Off White	1	10
T70BFI	Backfeed fitting insert. Bend radius insert to be used with T70BF.	Gray	1	10
T70WCIW	WORKSTATION OUTLET CENTER™ Offset Box for screw-on faceplates. Two-piece box and bracket accept any NEMA standard screw-on faceplate.	Off White	1	10
T70WC2IW	WORKSTATION OUTLET CENTER™ Offset Box for PAN-WAY® Snap-On Faceplates. Two-piece box and bracket accept any standard electrical outlet. Accepts any PAN-WAY® Snap-On Electrical/Communication Faceplates.	Off White	1	10

‡For other colors replace IW (Off White) with EI (Electric Ivory), IG (International Gray), or WH (White).
*WIREMOLD is a registered trademark of the Wiremold Co.

A.
System
Overview

B1.
Cable Ties

B2.
Cable
Accessories

B3.
Stainless
Steel Ties

C1.
Wiring
Duct

C2.
Surface
Raceway

C3.
Abrasion
Protection

C4.
Cable
Management

D1.
Terminals

D2.
Power
Connectors

D3.
Grounding
Connectors

E1.
Labeling
Systems

E2.
Labels

E3.
Pre-Printed
& Write-On
Markers

E4.
Permanent
Identification

E5.
Lockout/
Tagout
& Safety
Solutions

F.
Index

A. System Overview



PAN-WAY® Twin-70 Surface Raceway System

B1. Cable Ties

- UL and CSA rated 600 V; meets UL 5A and CSA C22.2 No. 62.1-03 standards; FT4 rated
- Separate channels allow independent access to power and communication cabling throughout the entire system
- Transitions to PANDUIT T-70, T-45, and LD profile raceway

- Compatible with NEMA standard 70mm faceplates or PAN-WAY® Classic Series Snap-On Faceplates
- Tamper resistant
- Supplied with pre-punched mounting holes

B2. Cable Accessories

B3. Stainless Steel Ties

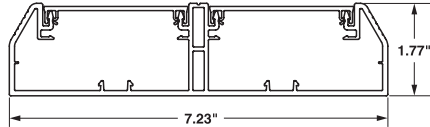

TWIN-70
Left Internal Area = 4.59 Sq. In.
Right Internal Area = 4.59 Sq. In.

C1. Wiring Duct



T702B

C2. Surface Raceway

C3. Abrasion Protection



T70C

C4. Cable Management

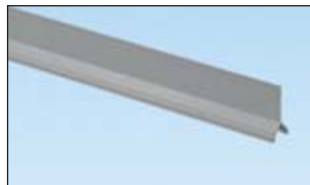

T70DW

D1. Terminals

D2. Power Connectors

D3. Grounding Connectors

E1. Labeling Systems

E2. Labels

E3. Pre-Printed & Write-On Markers

E4. Permanent Identification

E5. Lockout/Tagout & Safety Solutions

F. Index

Part Number	Part Description	Raceway Size	Color‡	Length (Ft.)	Std. Ctn. Qty.
Twin-70 Raceway Base					
T702BIW8	Twin-70 raceway base in 8' and 10' lengths. Supplied with pre-punched mounting holes.	7.23" x 1.77" (184.0mm x 45.0mm)	Off White	8	24
T702BIW10				10	30
T-70/TG-70/Twin-70 Raceway Cover					
T70CIW8	T-70, TG-70, or Twin-70 raceway cover in 8' and 10' lengths.	—	Off White	8	96
T70CIW10				10	120
T-70/Twin-70 Raceway Divider Wall					
T70DW8	T-70/Twin-70 raceway divider wall. Snaps onto rails in T-70/Twin-70 raceway base to create separate channels. Must use wire retainers to ensure channel separation per UL/CSA. Available in 8' and 10' lengths.	—	Gray	8	96
T70DW10				10	120

‡For other colors replace IW (Off White) with EI (Electric Ivory) or WH (White).
2' of cover needed for every 1' of Twin-70 base.
 Order number of feet required in multiples of standard carton quantity.



PAN-WAY® Twin-70 Raceway Fittings

- Twin-70 fittings are designed to maintain the TIA/EIA-568-B and 569-B required minimum bend radius for high performance copper and fiber optic cabling systems

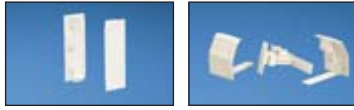

T70CC

T702BC



T702RA

T702IC



T702OC

T702T



T702EC

T702EE



T702TR

T702TRL



T702TRI

Part Number	Part Description	Color‡	Std. Pkg. Qty.	Std. Ctn. Qty.
T70CCIW-X	Cover coupler fitting. Used to join sections of cover together.	Off White	10	100
T702BCIW-X	Base coupler fitting. Used for joining sections of Twin-70 base together.	Off White	10	—
T702RAIW	Right angle fitting. Used to join sections of Twin-70 raceway at 90° flat junctions.	Off White	1	10
T702ICIW	Inside corner fitting. Used to join sections of Twin-70 raceway at inside corners.	Off White	1	10
T702OCIW	Outside corner fitting. Used to join sections of Twin-70 raceway at outside corners.	Off White	1	10
T702TIW	Tee fitting. Used to join sections of Twin-70 raceway at tee intersections.	Off White	1	5
T702ECIW	End cap fitting. Conduit breakouts of 1/2" for entry into raceway channel.	Off White	1	10
T702EEIW	Entrance end fitting. Conduit breakouts of 1/2", 3/4", 1", 1 1/4" and 1 1/2" for entry from ceiling or wall.	Off White	1	5
T702TRIW	Transition fitting. Used to transition to T-70 raceway.	Off White	1	5
T702TRLIW	Transition fitting. Used to transition to any LD profile or T-45 raceway.	Off White	1	5
T702TRI	Transition divider insert for Twin-70 to T-70 or Twin-70 to LD profile. Maintains channel separation within T702TR or T702TRL fittings.	Gray	1	10

‡For other colors replace IW (Off White) with EI (Electric Ivory) or WH (White). T702TRI available in Gray only.

A.
System
Overview

B1.
Cable Ties

B2.
Cable
Accessories

B3.
Stainless
Steel Ties

C1.
Wiring
Duct

C2.
Surface
Raceway

C3.
Abrasion
Protection

C4.
Cable
Management

D1.
Terminals

D2.
Power
Connectors

D3.
Grounding
Connectors

E1.
Labeling
Systems

E2.
Labels

E3.
Pre-Printed
& Write-On
Markers

E4.
Permanent
Identification

E5.
Lockout/
Tagout
& Safety
Solutions

F.
Index

A. System Overview



PAN-WAY® T-70 and Twin-70 Raceway Accessories

B1. Cable Ties

- T-70 and Twin-70 raceway accessories consist of device mounting brackets, snap-on device brackets, hanging boxes and 3-sided hanging boxes used to mount NEMA standard single gang electrical outlets and or communication devices

B2. Cable Accessories



T70DB-X



T70SDB-X

B3. Stainless Steel Ties



T70HB-X



T70HB3-X

C1. Wiring Duct

C2. Surface Raceway

C3. Abrasion Protection



T70HB3GFCI-X



T70WR-X

C4. Cable Management



T70S-X

D1. Terminals

D2. Power Connectors

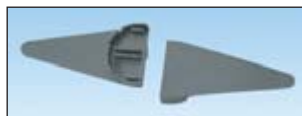

T70FSB

D3. Grounding Connectors

E1. Labeling Systems

E2. Labels

E3. Pre-Printed & Write-On Markers

E4. Permanent Identification

E5. Lockout/Tagout & Safety Solutions

F. Index

Part Number	Part Description	Color	Std. Pkg. Qty.	Std. Ctn. Qty.
T70DB-X	Device mounting bracket. Used to mount NEMA standard single gang electrical outlets and communication devices with either screw-on or snap-on single gang faceplates. Can be used with T-70, Twin-70, and TG-70 raceway.	Gray	10	—
T70SDB-X	Standard faceplate bracket. Used to mount NEMA standard 70mm single gang screw-on faceplates. Can be used with T-70, Twin-70, TG-70 raceway and PAN-POLE™ Communication Pole.	Gray	10	—
T70HB-X	Hanging box. Used to mount NEMA standard single gang electrical outlets and devices with either screw-on or snap-on single gang faceplates when there are communications cables in the raceway. For use in T-70 and Twin-70 raceway only.	Gray	10	—
T70HB3-X	3-sided hanging box. Used to mount NEMA standard single gang electrical outlets and devices with either screw-on or snap-on single gang faceplates when there are communications cables in the raceway. Box is low profile for increased channel capacity and does not require breakout removal. For use with T-70 and Twin-70 raceway only.	Gray	10	—
T70HB3GFCI-X	T70 GFCI 3-sided hanging box. Accepts single gang U.S. GFCI (ground fault circuit interrupter) standard electrical devices. Provides increased internal area for connections and excess wire.	Gray	10	—
T70WR-X	Wire retainer. Holds wires in place during installation.	Gray	10	100
T70S-X	Spacer plate. Used to mount the CBX4 surface mount box onto the T70DB-X or T70HB-X/T70HB3-X.	—	10	—
T70FSB	Fiber spool bracket. Each piece consists of two halves that snap into base of T-70 or Twin-70 raceway. Provides method to contain one meter or more of fiber slack and acts as a strain relief while maintaining a minimum 30mm bend radius. Bracket separation can be adjusted to fit the length of slack required.	Gray	1	10



Use the T70FSB with T-70 or Twin-70 raceway to contain 1m or more of fiber slack while maintaining a 30mm cable bend radius. Brackets are adjustable for slack length.



Use T70S-X spacer plate for mounting the CBX4 surface mount box on T-70 or T702.

Cable Fill Capacities for T-70 Raceway

This information is to be used as a guide in selecting the proper size raceway. The maximum amounts may vary according to the cable installation methods, straightness of cables, etc.

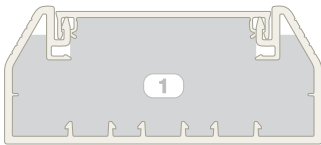

A = 5.15 in.²

Cable fill #1: Raceway with no devices.

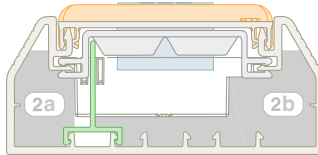

A = .86 in.² A = 1.72 in.²

Cable fill #2: Power and data using 3-sided hanging box and device bracket.

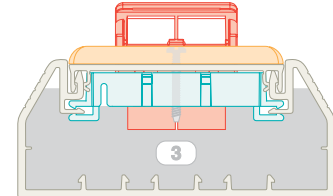

A = 3.67 in.²

Cable fill #3: Data only using vertical sloped screw-on communication faceplates.

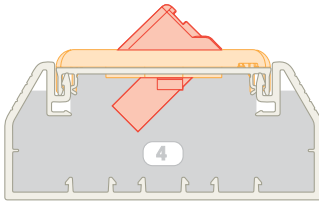

A = 4.71 in.²

Cable fill #4: Data only using horizontal sloped snap-on communication faceplates.

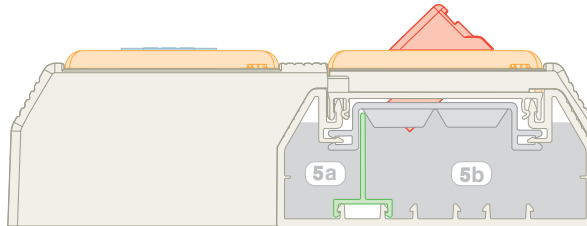

A = .91 in.² A = 3.12 in.²

Cable fill #5: Power and data using the *WORKSTATION OUTLET CENTER™* Offset Box.

SPEC = 40% cable fill – The recommended design in cable capacity, leaves room for future moves, adds, and changes.

MAX for Data = 60% cable fill – The maximum cable quantity based on cable interweaving and packing factors.

MAX for Power cable fill – The maximum of electrical cables based on UL temperature rise test.

Raceway Type and Configuration	Fill Area (In. ²)	Electrical Cables			Data Grade Cables		Data Grade Cables		Audio/Video		Fiber Optic Cable	
		14 AWG	12 AWG	10 AWG	24 AWG/UTP CM		24 AWG/UTP CM		RG6		2 Strand	
		THHN/T90			Cat 6. (4-pr.)		Augmented Cat. 6					
		0.111	0.130	0.164	DIA. = 0.250		DIA. = 0.330		DIA. = 0.275		DIA. = 0.175	
		FILL			FILL		FILL		FILL		FILL	
MAX	MAX	MAX	SPEC	MAX	SPEC	MAX	SPEC	MAX	SPEC	MAX	SPEC	
(UL Temp Rise Test)			(40%)	(60%)	(40%)	(60%)	(40%)	(60%)	(40%)	(60%)	(40%)	(60%)
1. T-70: No devices.	5.15	24	20	15	41	62	24	36	34	52	85	128
2a. T-70: Power and data using the 3-sided hanging box and device bracket.	0.86	14	11	7	—	—	—	—	—	—	—	—
2b.	1.72	—	—	—	14	21	8	12	11	17	28	42
3. T-70: Data only (screw-on faceplates).	3.67	—	—	—	29	44	17	25	24	37	61	91
4. T-70: Data only (snap-on faceplates).	4.71	—	—	—	38	57	22	33	31	47	78	117
5a. T-70: Power and data using the <i>WORKSTATION OUTLET CENTER™</i> Offset Box.	0.91	14	11	7	—	—	—	—	—	—	—	—
5b.	3.12	—	—	—	25	38	14	21	21	31	51	77

AWG dimensions represent typical outer cable diameter in inches.

A. System Overview

Cable Fill Capacities for Twin-70 Raceway

B1. Cable Ties

This information is to be used as a guide in selecting the proper size raceway. The maximum amounts may vary according to the cable installation methods, straightness of cables, etc.

B2. Cable Accessories

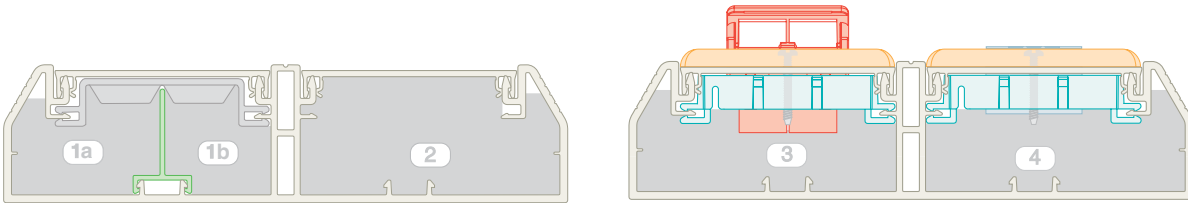

A = 2.05 in.² **A = 1.43 in.²** **A = 4.59 in.²** **A = 3.11 in.²** **A = 3.32 in.²**

Cable fill #1: Power and data with no devices. **Cable fill #2:** One Twin-70 channel with no devices. **Cable fill #3:** Data only using vertical sloped screw-on communication faceplates. **Cable fill #4:** Power using device bracket and NEMA standard 70mm screw-on faceplates.

B3. Stainless Steel Ties

C1. Wiring Duct

C2. Surface Raceway

C3. Abrasion Protection

C4. Cable Management

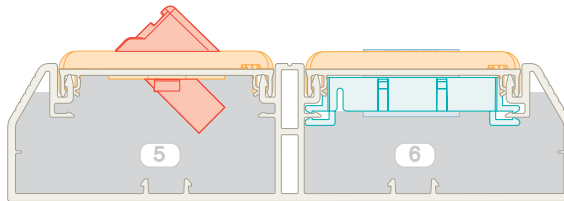

A = 4.14 in.² **A = 2.33 in.²**

Cable fill #5: Data only using horizontal sloped snap-on communication faceplates. **Cable fill #6:** 20 A TVSS rectangular outlet using device bracket and snap-on electrical/communication faceplate.

D1. Terminals

D2. Power Connectors

D3. Grounding Connectors

E1. Labeling Systems

E2. Labels

E3. Pre-Printed & Write-On Markers

E4. Permanent Identification

E5. Lockout/Tagout & Safety Solutions

F. Index

SPEC = 40% cable fill – The recommended design in cable capacity, leaves room for future moves, adds, and changes.

MAX for Data = 60% cable fill – The maximum cable quantity based on cable interweaving and packing factors.

MAX for Power cable fill – The maximum of electrical cables based on UL temperature rise test.

	Raceway Type and Configuration	Fill Area (In. ²)	Electrical Cables			Data Grade Cables		Data Grade Cables		Audio/Video		Fiber Optic Cable	
			14 AWG	12 AWG	10 AWG	24 AWG/UTP CM		24 AWG/UTP CM		RG6		2 Strand	
			THHN/T90			Cat 6. (4-pr.)		Augmented Cat. 6					
			0.111	0.130	0.164	DIA. = 0.250		DIA. = 0.330		DIA. = 0.275		DIA. = 0.175	
			FILL			FILL		FILL		FILL		FILL	
MAX	MAX	MAX	SPEC	MAX	SPEC	MAX	SPEC	MAX	SPEC	MAX	SPEC	MAX	
(UL Temp Rise Test)			(40%)	(60%)	(40%)	(60%)	(40%)	(60%)	(40%)	(60%)	(40%)	(60%)	
1a.	Twin-70: Power and data, no terminations.	2.05	—	—	—	16	25	9	14	13	20	34	51
1b.		1.43	16	16	15	—	—	—	—	—	—	—	—
2.	Twin-70: One channel no devices (data).	4.59	—	—	—	37	56	21	32	30	46	76	114
3.	Twin-70: Data only (screw-on faceplate).	3.11	—	—	—	25	38	14	21	20	31	51	77
4.	Twin-70: Power only (screw-on faceplate).	3.32	15	13	13	—	—	—	—	—	—	—	—
5.	Twin-70: Data only (snap-on faceplate).	4.14	—	—	—	33	50	19	29	27	41	68	103
6.	Twin-70: TVSS power (snap-on faceplate).	2.33	16	16	14	—	—	—	—	—	—	—	—

AWG dimensions represent typical outer cable diameter in inches.

PAN-WAY® T-45 Non-Metallic Surface Raceway

PAN-WAY® T-45 Non-Metallic Surface Raceway is a multi-channel raceway which provides a solution for routing copper, fiber optic, and/or power cabling along fixed perimeter walls. T-45 surface raceway terminates using the T-45 hinged data and power brackets, T-45 offset box, and select PAN-WAY® Surface Mount Outlet Boxes.



- Multi-directional cover hinge allows cable installation from either side
- Hinged data and power brackets provide easy access for terminating outlets
- Aesthetically pleasing
- Lightweight
- Tamper resistant
- Fittings maintain 1 inch bend radius control

PAN-WAY® T-45 Surface Raceway accepts NEMA standard screw-on faceplates for superior PAN-WAY® Snap-On Faceplates when terminating with the T-45 offset box and surface mount outlet boxes. Fittings for T-45 are available to transition to PAN-WAY® LD Series Raceway.

A.
System
Overview

B1.
Cable Ties

B2.
Cable
Accessories

B3.
Stainless
Steel Ties

C1.
Wiring
Duct

C2.
Surface
Raceway

C3.
Abrasion
Protection

C4.
Cable
Management

D1.
Terminals

D2.
Power
Connectors

D3.
Grounding
Connectors

E1.
Labeling
Systems

E2.
Labels

E3.
Pre-Printed
& Write-On
Markers

E4.
Permanent
Identification

E5.
Lockout/
Tagout
& Safety
Solutions

F.
Index

A.
System
Overview

T-45 Raceway Roadmap

B1.
Cable Ties

B2.
Cable
Accessories

B3.
Stainless
Steel Ties

C1.
Wiring
Duct

C2.
Surface
Raceway

C3.
Abrasion
Protection

C4.
Cable
Management

D1.
Terminals

D2.
Power
Connectors

D3.
Grounding
Connectors

E1.
Labeling
Systems

E2.
Labels

E3.
Pre-Printed
& Write-On
Markers

E4.
Permanent
Identification

E5.
Lockout/
Tagout/
& Safety
Solutions

F.
Index

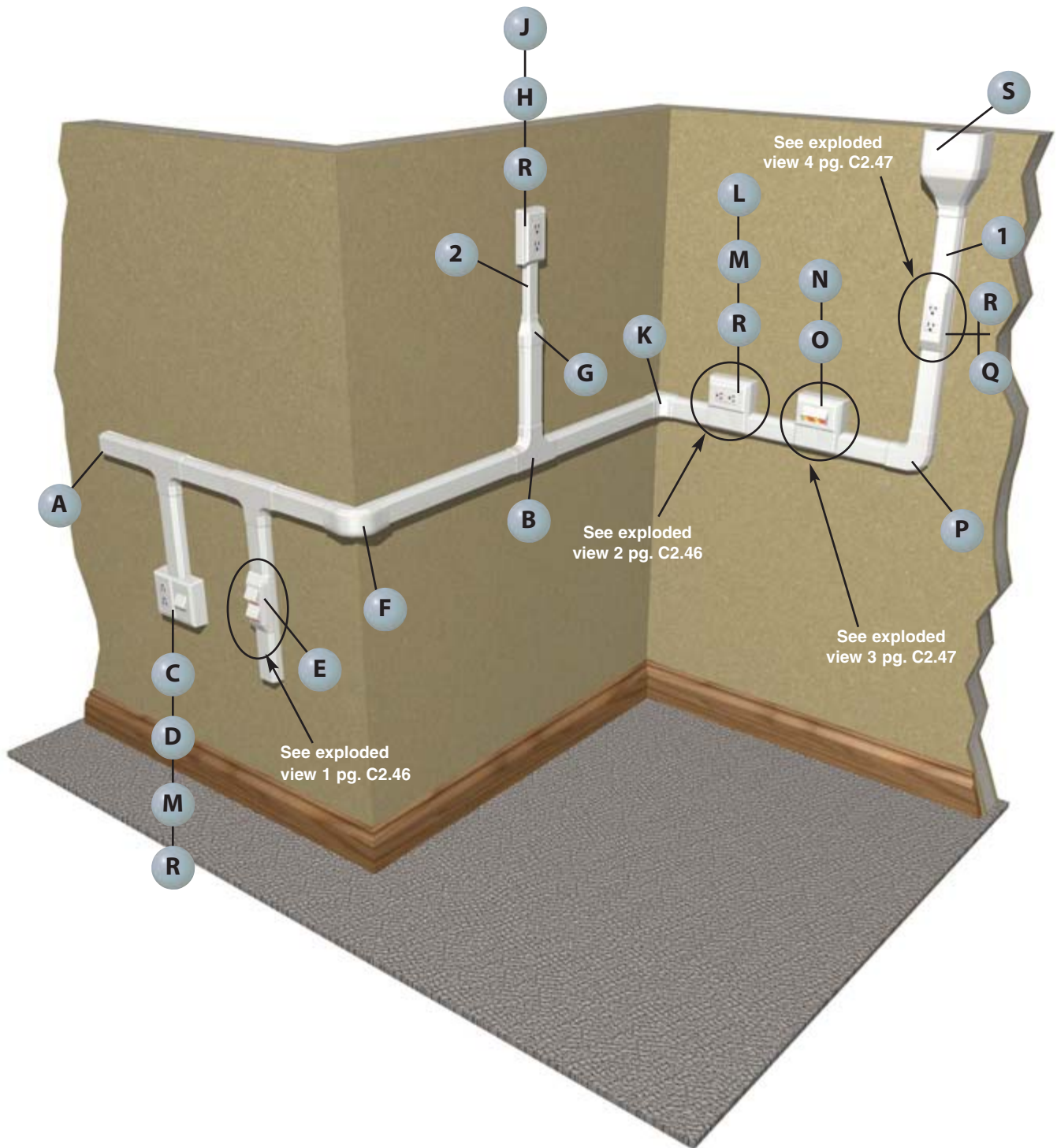

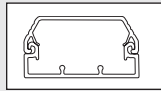

1 T45B** , T45C** – T-45 Raceway (page C2.48)

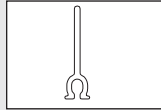

1 T45DW** – T-45 Divider Wall (page C2.48)

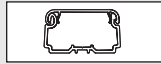

2 LDPH10** – LDPH Raceway (page C2.77)



A T45EC** – T-45 End Cap Fitting (page C2.49)



B T45T** and T45TD – T-45 Tee Fitting and Divider (page C2.49)

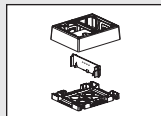

C JBP2FS** – *FAST-SNAP™* Double Gang Power Rated Surface Mount Outlet Box (page C2.52)

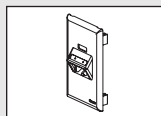

D UIT70FV2** – *ULTIMATE ID®* Sloped Vertical Snap-On Faceplate

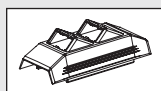

E T45HDB** – T-45 Snap-On Hinged Data Bracket (page C2.49)

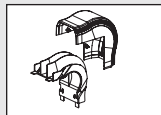

F T45OC** – T-45 Outside Corner Fitting (page C2.49)

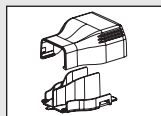

G T45RLD** – T-45 Reducer Fitting (page C2.49)

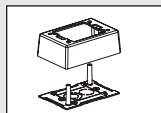

H JBP1** – Power Rated Single Gang Two-Piece Box (page C2.58)

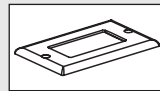

J CPG** – Single Gang Rectangular Electrical/Communication Screw-On Faceplate (page C2.59)

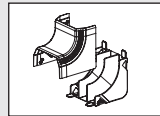

K T45IC** – T-45 Inside Corner Fitting (page C2.49)

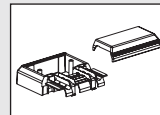

L T45WC** – T-45 Offset Box for Screw-On Faceplates/Receptacles (page C2.49)

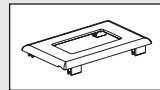

M T70PG** – Single Gang Rectangular Electrical/Communication Snap-On Faceplate (page C2.53)

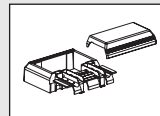

N T45WC2** – T-45 Offset Box for Snap-On Faceplates (page C2.49)

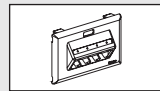

O UIT70FH4** – *ULTIMATE ID®* Sloped Horizontal Snap-On Faceplate

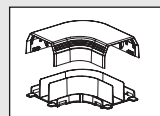

P T45RA** – T-45 Right Angle Fitting (page C2.49)

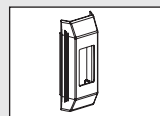

Q T45HEGB** – T-45 Electrical Bracket (page C2.49)

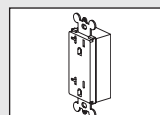

R ERU20** – 20 A Rectangular Electrical Outlet (page C2.60)

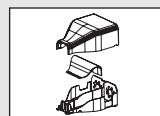

S T45EE** – T-45 Entrance End Fitting (page C2.49)

A. System Overview

B1. Cable Ties

B2. Cable Accessories

B3. Stainless Steel Ties

C1. Wiring Duct

C2. Surface Raceway

C3. Abrasion Protection

C4. Cable Management

D1. Terminals

D2. Power Connectors

D3. Grounding Connectors

E1. Labeling Systems

E2. Labels

E3. Pre-Printed & Write-On Markers

E4. Permanent Identification

E5. Lockout/Tagout & Safety Solutions

F. Index

A.
System
Overview

T-45 Configurations

B1.
Cable Ties

Exploded View 1

	Components Required	See page
A.	T45HDB = T-45 snap-on hinged data bracket.	C2.51
B.	MINI-COM® Modules.	—

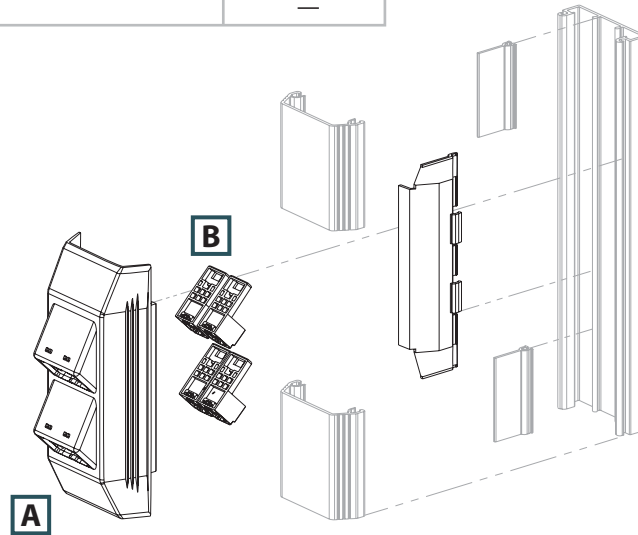

B3.
Stainless
Steel Ties

C1.
Wiring
Duct

C2.
Surface
Raceway

C3.
Abrasion
Protection

C4.
Cable
Management

Exploded View 2

	Components Required	See page
A.	T70PG = Single gang rectangular electrical/communication snap-on faceplate.	C2.55
B.	ERU20 = 20 A rectangular electrical outlet (screws included).	C2.62
C.	T45WC = T-45 offset box for screw-on faceplates/receptacles.	C2.51

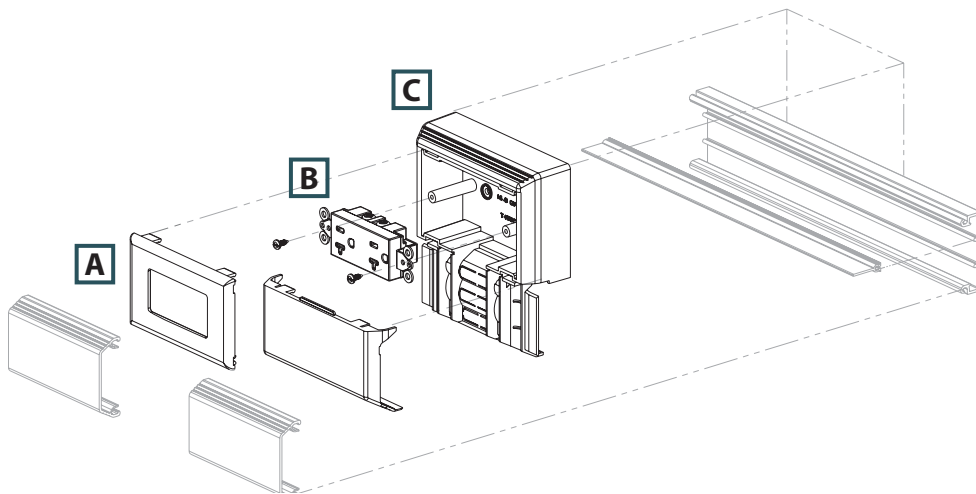

E1.
Labeling
Systems

E2.
Labels

E3.
Pre-Printed
& Write-On
Markers

E4.
Permanent
Identification

E5.
Lockout/
Tagout/
& Safety
Solutions

F.
Index

T-45 Configurations (continued)

Exploded View 3

	Components Required	See page
A.	UIT70FH4 = <i>ULTIMATE ID</i> ® Sloped Horizontal Faceplates – 4-Port.	—
B.	<i>MINI-COM</i> ® Modules.	—
C.	T45WC2 = T-45 offset box for snap-on faceplates.	C2.49

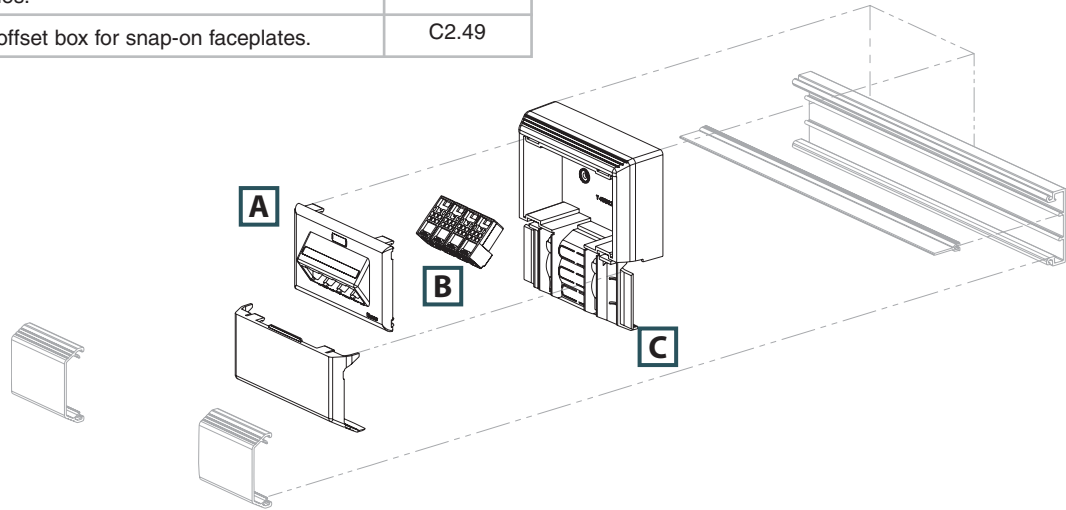

Exploded View 4

	Components Required	See page
A.	T45HEGB = T-45 electrical bracket for rectangular outlet.	C2.59
B.	ERU20 = 20 A rectangular electrical outlet (screws included).	C2.60

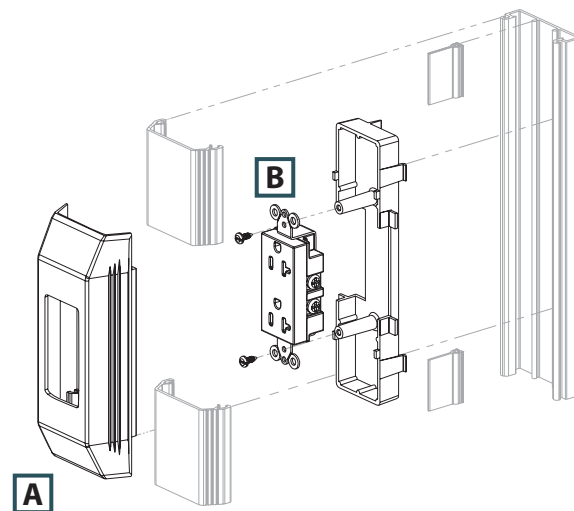

A.
System
Overview

B1.
Cable Ties

B2.
Cable
Accessories

B3.
Stainless
Steel Ties

C1.
Wiring
Duct

C2.
Surface
Raceway

C3.
Abrasion
Protection

C4.
Cable
Management

D1.
Terminals

D2.
Power
Connectors

D3.
Grounding
Connectors

E1.
Labeling
Systems

E2.
Labels

E3.
Pre-Printed
& Write-On
Markers

E4.
Permanent
Identification

E5.
Lockout/
Tagout/
& Safety
Solutions

F.
Index

A. System Overview



PAN-WAY® T-45 Surface Raceway System

B1. Cable Ties

- UL and CSA rated 600 V; meets UL 5A and CSA C22.2 No. 62.1-03 standards; FT4 rated
- Hinged cover allows easy access from either side
- Optional factory applied adhesive backing speeds installation

- Supplied with pre-punched mounting holes
- Tamper resistant
- Terminates using the T-45 hinged data or power brackets, offset box, or surface mount outlet box solutions

B2. Cable Accessories

B3. Stainless Steel Ties

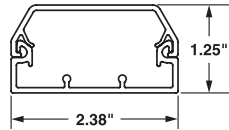

T-45
Internal Area = 2.12 Sq. In.

C1. Wiring Duct



T45B

C2. Surface Raceway



T45C

C3. Abrasion Protection

C4. Cable Management

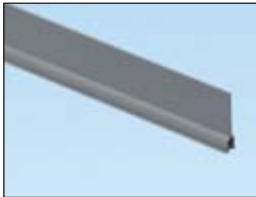

T45DW

D1. Terminals

D2. Power Connectors

D3. Grounding Connectors

E1. Labeling Systems

E2. Labels

E3. Pre-Printed & Write-On Markers

E4. Permanent Identification

E5. Lockout/Tagout & Safety Solutions

F. Index

Part Number	Part Description	Raceway Size	Color‡	Length (Ft.)	Std. Ctn. Qty.
T-45 Raceway Base with Adhesive					
T45BIW8-A	T-45 raceway base in 8' and 10' lengths with adhesive. Supplied with pre-punched mounting holes.	2.38" x 1.25" (60.3mm x 32.0mm)	Off White	8	160
T45BIW10-A		2.38" x 1.25" (60.3mm x 32.0mm)		10	200
T-45 Raceway Base without Adhesive					
T45BIW8	T-45 raceway base in 8' and 10' lengths with adhesive. Supplied with pre-punched mounting holes.	2.38" x 1.25" (60.3mm x 32.0mm)	Off White	8	160
T45BIW10				10	200
T-45 Raceway Cover					
T45CIW8	T-45 raceway cover in 8' and 10' lengths. Can be hinged open on either side of T-45 base.	—	Off White	8	160
T45CIW10				10	200
T-45 Raceway Divider Wall					
T45DW8	T-45 divider wall. Snaps onto rails in T-45 raceway base to create separate channels. Must use wire retainers to ensure channel separation per UL/CSA. Available in 8' and 10' lengths.	—	Gray	8	160
T45DW10				10	200

‡For other colors replace IW (Off White) with EI (Electric Ivory).
Order base and cover separately.
Order number of feet required in multiples of standard carton quantity.



PAN-WAY® T-45 Raceway Fittings

- T-45 fittings are designed to maintain the TIA/EIA-568-B and 569-B required minimum bend radius for high performance copper and fiber optic cabling systems



T45CC

T45RA



T45IC

T45OC



T45T

T45TD

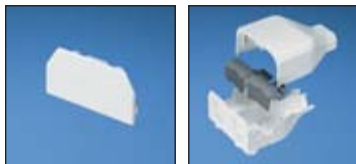

T45EC

T45EE



T45RLD

T45TRI

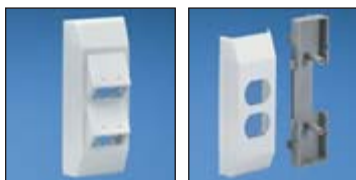

T45HDB

T45HEB

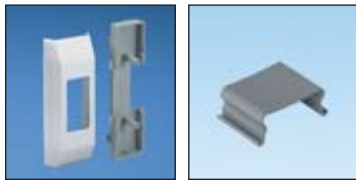

T45HEGB

T45WR-X



T45WC

T45WC2

Part Number	Part Description	Color‡	Std. Pkg. Qty.	Std. Ctn. Qty.
T45CCIW-X	Cover coupler fitting. Used to join two pieces of T-45 cover together.	Off White	10	100
T45RAIW	Right angle fitting. Used to join sections of T-45 raceway at 90° flat junction.	Off White	1	10
T45ICIW	Inside corner fitting. Used to join T-45 raceway at inside corner.	Off White	1	10
T45OCIW	Outside corner fitting. Used to join T-45 raceway at 90° outside corner.	Off White	1	10
T45TIW	Tee fitting. Used to join T-45 raceway at tee intersections.	Off White	1	10
T45TD	Divided insert. Used to separate power and data within the T45T.	Gray	1	10
T45ECIW	End cap fitting. Used to terminate T-45 raceway.	Off White	1	10
T45EEIW	Entrance end fitting. With knockouts for 1/2", 3/4", 1" and 1 1/4" conduit which allows entry from ceiling or wall.	Off White	1	10
T45RLDIW	Reducer fitting. Reduces from T-45 to LD10 profile raceway.	Off White	1	10
T45TRI	Provides bend radius control at transition from T-70 to T-45 when used with T70TR.	Gray	1	10
T45HDBIW	Snap-on hinged data bracket. Used for mounting <i>PANDUIT® MINI-COM®</i> Modules vertically inline within T-45 raceway. Can be hinged opened on either side of T-45 base.	Off White	1	10
T45HEBIW	Electrical bracket and box. Used for mounting standard duplex electrical outlets.	Off White	1	10
T45HEGBIW	Electrical bracket and box. Used for mounting standard rectangular style electrical outlets.	Off White	1	10
T45WR-X	Wire retainers. Used to hold wires in place during installation.	Gray	10	100
T45WCIW	Offset box. Allows for the mounting of any standard electrical or communication outlet offset from the raceway channel. Box accepts any NEMA standard screw-on faceplate or <i>PAN-WAY®</i> Electrical Snap-On Faceplates.	Off White	1	10
T45WC2IW	Offset box. Box accepts any <i>PAN-WAY®</i> Communication Snap-On Faceplates.	Off White	1	10

‡For other colors replace IW (Off White) with EI (Electric Ivory). T45TD, T45TRI, and T45WR-X available in Gray only.

A. System Overview

B1. Cable Ties

B2. Cable Accessories

B3. Stainless Steel Ties

C1. Wiring Duct

C2. Surface Raceway

C3. Abrasion Protection

C4. Cable Management

D1. Terminals

D2. Power Connectors

D3. Grounding Connectors

E1. Labeling Systems

E2. Labels

E3. Pre-Printed & Write-On Markers

E4. Permanent Identification

E5. Lockout/Tagout & Safety Solutions

F. Index

A. System Overview

Cable Fill Capacities for T-45 Raceway

This information is to be used as a guide in selecting the proper size raceway. The maximum amounts may vary according to the cable installation methods, straightness of cables, etc.

B1. Cable Ties



A = 2.13 in.²

Cable fill #1: T-45 with no devices.



A = 1.72 in.²

Cable fill #2: T-45 with wire retainer.

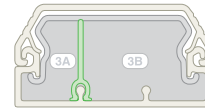

A = .44 in.²

B = 1.20 in.²

Cable fill #3: Power and data using a wire retainer and divider wall.

B2. Cable Accessories

B3. Stainless Steel Ties

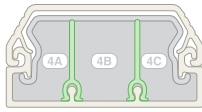

A = .44 in.²

B = .68 in.²

C = .44 in.²

Cable fill #4: Power and data using a wire retainer and divider walls.

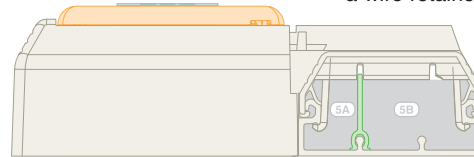

A = .41 in.²

B = 1.06 in.²

Cable fill #5: Power and data using the offset box.

C1. Wiring Duct

C2. Surface Raceway

C3. Abrasion Protection

C4. Cable Management

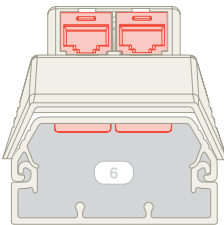

A = 2.00 in.²

Cable fill #6: Data only using hinged data bracket.

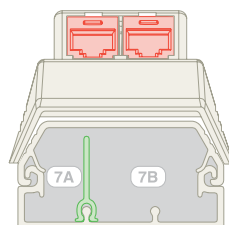

A = .52 in.²

B = 1.2 in.²

Cable fill #7: Power and data using hinged data bracket with divider insert.

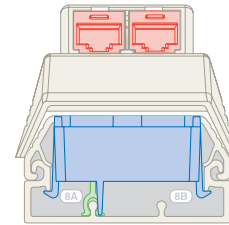

A = .22 in.²

B = .5 in.²

Cable fill #8: Power and data using electrical bracket/box and hinged data bracket.

D1. Terminals

SPEC = 40% cable fill – The recommended design in cable capacity, leaves room for future moves, adds, and changes.

MAX for Data = 60% cable fill – The maximum cable quantity based on cable interweaving and packing factors.

MAX for Power cable fill – The maximum of electrical cables based on UL temperature rise test.

D2. Power Connectors

D3. Grounding Connectors

E1. Labeling Systems

E2. Labels

E3. Pre-Printed & Write-On Markers

E4. Permanent Identification

E5. Lockout/Tagout & Safety Solutions

F. Index

Raceway Type and Configuration	Fill Area (In. ²)	Electrical Cables			Data Grade Cables		Data Grade Cables		Audio/Video		Fiber Optic Cable			
		14 AWG	12 AWG	10 AWG	23/24 AWG/UTP	23 AWG/UTP CM	RG6		2 Strand					
		THHN/T90			Cat 6. (4-pr.)		Augmented Cat. 6							
		0.111	0.130	0.164	DIA. = .250		DIA. = .354		DIA. = .275		DIA. = .175			
		FILL			FILL		FILL		FILL		FILL			
		MAX	MAX	MAX	SPEC	MAX	SPEC	MAX	SPEC	MAX	SPEC	MAX	MAX	
(UL Temp Rise Test)			(40%)		(60%)		(40%)		(60%)		(40%)		(60%)	
1. T-45: No devices.	2.13	36	27	25	17	26	9	14	14	21	35	53		
2. T-45: No devices with wire retainer.	1.72	36	27	25	14	21	8	12	11	17	28	42		
3A. T-45: Power and data with wire retainer and divider wall	0.44	12	11	8	—	—	—	—	—	—	—	—		
3B. (2 channels).	1.20	—	—	—	9	14	5	8	8	12	19	29		
4A. T-45: Power and data with wire retainer and two divider walls	0.44	12	11	8	3	5	2	3	2	4	7	10		
4B. (three channels).	0.68	—	—	—	5	8	3	4	4	6	11	16		
4C.	0.44	—	—	—	3	5	2	3	2	4	7	10		
5A. T-45: Power and data using the offset box.	0.41	12	11	8	—	—	—	—	—	—	—	—		
5B.	1.06	—	—	—	8	12	4	7	7	10	17	26		
6. T-45: Data only using data bracket.	2.00	—	—	—	16	24	9	14	13	20	33	49		
7A. T-45: Power and data using hinged data bracket with divider insert.	0.52	12	11	8	—	—	—	—	—	—	—	—		
7B.	1.2	—	—	—	9	14	5	8	8	12	19	29		
8A. T-45: Power and data using electrical bracket and box.	0.22	9	7	4	—	—	—	—	—	—	—	—		
8B.	0.5	—	—	—	4	6	2	3	3	5	8	12		

AWG dimensions represent typical outer cable diameter in inches.

PAN-WAY[®] SNAP-ON FACEPLATES AND SURFACE MOUNT OUTLET BOXES

PAN-WAY[®] Snap-On Faceplates are designed for use with PANDUIT surface raceway systems and install faster than conventional screw-on faceplates, reducing labor costs and providing a more aesthetic appearance. PAN-WAY[®] Snap-On Communication Faceplates are available in vertical and horizontal orientation and accept PANDUIT[®] MINI-COM[®] Copper and Fiber Optic Modules. Electrical outlets are available in colors to complement PANDUIT raceway and are available in 20 A, 106 duplex, rectangular, TVSS and GFCI.



- Snap-on faceplates install without the use of screws providing faster installation and superior aesthetics
- FAST-SNAP[™] Boxes assemble without the use of screws and accept PAN-WAY[®] Snap-On Faceplates
- Snap-on communication faceplates are available in horizontal or vertical sloped outlet configurations
- Snap-on electrical faceplates are available in 106 duplex or rectangular styles

Surface mount outlet boxes are available for both power and communication applications. They are compatible with PAN-WAY[®] LD, LDPH, LD2P10 and T-45 Raceway Systems. PAN-WAY[®] Snap-On Faceplates mount directly to Cove, TG-70, T-70, Twin-70 raceways, PAN-WAY[®] FAST-SNAP[™] Boxes and PAN-POLE[™] Aluminum Outlet Poles.

A.
System
Overview

B1.
Cable Ties

B2.
Cable
Accessories

B3.
Stainless
Steel Ties

C1.
Wiring
Duct

C2.
Surface
Raceway

C3.
Abrasion
Protection

C4.
Cable
Management

D1.
Terminals

D2.
Power
Connectors

D3.
Grounding
Connectors

E1.
Labeling
Systems

E2.
Labels

E3.
Pre-Printed
& Write-On
Markers

E4.
Permanent
Identification

E5.
Lockout/
Tagout
& Safety
Solutions

F.
Index

A. System Overview



PAN-WAY® FAST-SNAP™ Surface Mount Outlet Boxes

B1. Cable Ties

- JB1FS and JBP2FS assemble without the use of screws for faster installation
- JB1FS and JBP2FS are supplied with adhesive backing to speed installation

- JB1FS and JBP2FS accept PAN-WAY® Snap-on Faceplates for superior aesthetics

B2. Cable Accessories



JB1FS**-A

B3. Stainless Steel Ties



JBP2FS**

C1. Wiring Duct

C2. Surface Raceway

C3. Abrasion Protection

C4. Cable Management

Part Number	Part Description	Color‡	Std. Pkg. Qty.	Std. Ctn. Qty.
JB1FSIW-A	Single gang two-piece snap together outlet box with adhesive backing. Box accepts PAN-WAY® Snap-On Faceplates. For use with PAN-WAY® T-45 or LD profile raceway. 5.00"L x 3.26"W x 1.62"H (127.1mm x 82.7mm x 41.1mm). Breakouts for 1/2", 3/4", or 1" diameter conduit.	Off White	1	10
JBP2FSIW	Double gang power rated two-piece snap together outlet box. Box accepts PAN-WAY® Snap-On Faceplates. For use with PAN-WAY® T-45 or LD profile raceway. 5.00"L x 6.14"W x 1.62"H (127.1mm x 155.9mm x 41.1mm). Breakouts for 1/2", 3/4", or 1" diameter conduit.	Off White	1	10

‡For other colors replace IW (Off White) with EI (Electric Ivory), IG (International Gray), or WH (White). For complete labeling solutions and product information, reference chart below.



PAN-WAY® Classic Series Snap-On Faceplates for Use with PANDUIT® MINI-COM® Modules

- Can be used with PAN-WAY® Cove, TG-70, T-70, Twin-70, T-45 Raceway Systems, FAST-SNAP™ Outlet Boxes and PAN-POLE™ Aluminum Outlet Pole

D1. Terminals



T70FH2



T70FH4

D2. Power Connectors

D3. Grounding Connectors



T70FV2



T70FV4

E1. Labeling Systems

E2. Labels

E3. Pre-Printed & Write-On Markers

E4. Permanent Identification

E5. Lockout/Tagout & Safety Solutions

F. Index

Part Number	Part Description	Color‡	Std. Pkg. Qty.	Std. Ctn. Qty.
T70FH2IW	Snap-on horizontal sloped communication faceplate. Accepts two PANDUIT® MINI-COM® Modules (not included). No additional mounting hardware required.	Off White	1	10
T70FH4IW	Snap-on horizontal sloped communication faceplate. Accepts four PANDUIT® MINI-COM® Modules (not included). No additional mounting hardware required.	Off White	1	10
T70FV2IW	Snap-on vertical sloped communication faceplate. Accepts two PANDUIT® MINI-COM® Modules (not included). No additional mounting hardware required.	Off White	1	10
T70FV4IW	Snap-on vertical sloped communication faceplate. Accepts four PANDUIT® MINI-COM® Modules (not included). No additional mounting hardware required.	Off White	1	10

‡For other colors replace IW (Off White) with EI (Electric Ivory), IG (International Gray), or WH (White). For complete labeling solutions and product information, reference chart below.

Component Labels for PAN-WAY® Classic Series Snap-On Faceplates for Use with PANDUIT® MINI-COM® Modules and Inserts



Faceplate Part Number	Suggested Label Solutions for TIA/EIA-606-A Compliance			
	Laser/Ink Jet Desktop Printer Label	TDP43MY Thermal Transfer Desktop Printer Label	PANTHER™ LS8E Hand-Held Printer Label	COUGAR™ LS9 Hand-Held Printer Label
T70FH2IW	C125X030FJJ	C125X030YPT	C125X030FJC	T031X000FJC-BK
T70FV2IW				
T70FV4IW				
All T70B Parts				
T70FH4IW	C252X030FJJ	C252X030YPT	C252X030FJC	T031X000FJC-BK



PAN-WAY® Classic Series Snap-On Faceplates for Use with PANDUIT® MINI-COM® Inserts

- Single gang vertical or horizontal sloped communication faceplates accept one or two PANDUIT® MINI-COM® Inserts
- Can be used with PAN-WAY® Cove, TG-70, T-70, Twin-70, T-45 Raceway Systems, FAST-SNAP™ Outlet Boxes and PAN-POLE™ Aluminum Outlet Pole



T70BH1



T70BH2



T70B1



T70B2

Part Number	Part Description	Color‡	Std. Pkg. Qty.	Std. Ctn. Qty.
T70BH1IW	Snap-on horizontal communication faceplate. Accepts one 1/2-size PANDUIT® MINI-COM® Insert and two modules. No additional mounting hardware required.	Off White	1	10
T70BH2IW	Snap-on horizontal communication faceplate. Accepts two 1/2-size PANDUIT® MINI-COM® Inserts and four modules. No additional mounting hardware required.	Off White	1	10
T70B1IW	Snap-on vertical communication faceplate. Holds one 1/2-size PANDUIT® MINI-COM® Insert and two modules. No additional mounting hardware required.	Off White	1	10
T70B2IW	Snap-on vertical communication faceplate. Holds two 1/2-size PANDUIT® MINI-COM® Inserts and four modules. No additional mounting hardware required.	Off White	1	10

‡For other colors replace IW (Off White) with EI (Electric Ivory), IG (International Gray), or WH (White). For complete labeling solutions and product information, reference chart on previous page.



PAN-WAY® Classic Series Snap-On Faceplates for Communication/Power

- Can be used with PAN-WAY® Cove, TG-70, T-70, Twin-70, T-45 Raceway Systems, FAST-SNAP™ Outlet Boxes and PAN-POLE™ Aluminum Outlet Pole



T70P



T70PG



T70PS



T70PGS



T70PN

Part Number	Part Description	Color‡	Std. Pkg. Qty.	Std. Ctn. Qty.
T70PIW	Snap-on single gang 106 duplex electrical/communication faceplate. Used to cover one NEMA standard 106 duplex electrical outlet. In communication applications, covers one standard 106 duplex communication module frame.	Off White	1	10
T70PGIW	Snap-on single gang rectangular electrical/communication faceplate. Used to cover one NEMA standard rectangular electrical outlet. In communication applications, covers one standard rectangular communication module frame.	Off White	1	10
T70PSIW	Snap-on single gang 106 duplex communication faceplate. Used to cover one NEMA standard 106 duplex communication module frame. Module frame screw mounts directly to underside of snap-on faceplate. No mounting device needed. Supplied with one mounting screw. Note: Not for use with electrical devices.	Off White	1	10
T70PGSIW	Snap-on single gang rectangular communication faceplate. Used to cover one NEMA standard rectangular communication module frame. Module frame screw mounts directly to underside of snap-on faceplate. No mounting device needed. Supplied with two mounting screws. Note: Not for use with electrical devices.	Off White	1	10
T70PNIW	Snap-on single gang blank cover faceplate.	Off White	1	10

‡For other colors replace IW (Off White) with EI (Electric Ivory), IG (International Gray), or WH (White). Component Labels for PAN-WAY® Classic Series Snap-On Faceplates for Communication and Power, please reference pg. C2.59.

A. System Overview

B1. Cable Ties

B2. Cable Accessories

B3. Stainless Steel Ties

C1. Wiring Duct

C2. Surface Raceway

C3. Abrasion Protection

C4. Cable Management

D1. Terminals

D2. Power Connectors

D3. Grounding Connectors

E1. Labeling Systems

E2. Labels

E3. Pre-Printed & Write-On Markers

E4. Permanent Identification

E5. Lockout/Tagout & Safety Solutions

F. Index

A. System Overview



PANDUIT® NETKEY® Snap-On Sloped Keystone Faceplates

B1. Cable Ties

- Accept all PANDUIT® NETKEY® Keystone Copper Modules and Duplex Fiber Optic Modules
- Snap into raceway channel, requires no additional mounting hardware or adapters – greatly reducing installation time
- Lowest cost for moves, adds, and changes

- Tamper resistant
- Can be used with PAN-WAY® Cove, TG-70, T70, Twin-70, T-45 Raceway Systems, FAST-SNAP™ Outlet Boxes, and PAN-POLE™ Aluminum Outlet Poles

B2. Cable Accessories

B3. Stainless Steel Ties

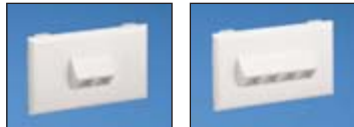

NK2HSRF

NK4HSRF

C1. Wiring Duct



NK4VSRF

C2. Surface Raceway

C3. Abrasion Protection

C4. Cable Management

Part Number	Part Description	Color‡	Std. Pkg. Qty.	Std. Ctn. Qty.
NK2HSRFIW	Snap-on 2-position sloped horizontal faceplate accepts any PANDUIT® NETKEY® Module. Compatible with PANDUIT® FAST-SNAP™ Outlet Boxes, Surface Raceway Systems, and PAN-POLE™ Outlet Poles.	Off White	1	10
NK4HSRFIW	Snap-on 4-position sloped horizontal faceplate accepts any PANDUIT® NETKEY® Module. Compatible with PANDUIT® FAST-SNAP™ Outlet Boxes, Surface Raceway Systems, and PAN-POLE™ Outlet Poles.	Off White	1	10
NK4VSRFIW	Snap-on 4-position sloped vertical faceplate accepts any PANDUIT® NETKEY® Module. Compatible with PANDUIT® FAST-SNAP™ Outlet Boxes, Surface Raceway Systems, and PAN-POLE™ Outlet Poles.	Off White	1	10

PANDUIT® NETKEY® faceplates are NOT compatible with PANDUIT® MINI-COM® Modules.

‡For other colors replace IW (Off White) with EI (Electric Ivory), IG (International Gray), or WH (White).

For complete labeling solutions, reference chart below.



PANDUIT® NETKEY® Snap-On Flush Universal Keystone Faceplates

D1. Terminals

- Wider module spacing to accept common manufacturers' keystone modules .900 inches wide or less

- Can be used with PAN-WAY® Cove, TG-70, T70, Twin-70, T-45 Raceway Systems, FAST-SNAP™ Outlet Boxes, and PAN-POLE™ Aluminum Outlet Poles

D2. Power Connectors



T70KW2

T70KW4

D3. Grounding Connectors

E1. Labeling Systems

E2. Labels

E3. Pre-Printed & Write-On Markers

E4. Permanent Identification

E5. Lockout/Tagout & Safety Solutions

F. Index

Part Number	Part Description	Color‡	Std. Pkg. Qty.	Std. Ctn. Qty.
T70KW2IW	Snap-on 2-position flush mount faceplate accepts any PANDUIT® NETKEY® Module and most other manufacturers' keystone modules. Compatible with PANDUIT® FAST-SNAP™ Outlet Boxes, Surface Raceway Systems, and PAN-POLE™ Outlet Poles.	Off White	1	10
T70KW4IW	Snap-on 4-position flush mount faceplate accepts any PANDUIT® NETKEY® Module and most other manufacturers' keystone modules. Compatible with PANDUIT® FAST-SNAP™ Outlet Boxes, Surface Raceway Systems, and PAN-POLE™ Outlet Poles.	Off White	1	10

PANDUIT® NETKEY® faceplates are NOT compatible with PANDUIT® MINI-COM® Modules.

‡For other colors replace IW (Off White) with EI (Electric Ivory), IG (International Gray), or WH (White).

For complete labeling solutions, reference chart below.

Component Labels for Snap-On “Sloped” (Keystone) Faceplates and Snap-On “Flush” Universal (Keystone) Faceplates

Suggested Label Solutions for TIA/EIA-606-A Compliance			
Faceplate Part Number	Laser/Ink Jet Desktop Printer Label	PANTHER™ LS8E Hand-Held Printer Label	COUGAR™ LS9 Hand-Held Printer Label
NK2HSRFIW T70KW2IW	C125X030FJJ	C125X030FJC	T031X000FJC-BK
NK4VSRFIW	2-C125X030FJJ	2-C125X030FJC	
NK4HSRFIW T70KW4IW	C261X030FJJ	C125X030FJC	



PAN-WAY® Snap-On Faceplates for SYSTIMAX* Communication Modules

• Can be used with PAN-WAY® Cove, TG-70, T70, Twin-70, T-45 Raceway Systems, FAST-SNAP™ Outlet Boxes, and PAN-POLE™ Aluminum Outlet Poles



T70L2



T70L4



T70LV2

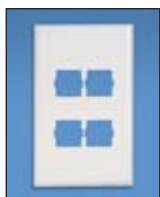

T70LV4

Part Number	Part Description	Color‡	Std. Pkg. Qty.	Std. Ctn. Qty.
T70L2IW	Snap-on horizontal communication faceplate designed to accept two SYSTIMAX* communication modules (not included). Can be used with PANDUIT surface raceway systems and boxes that accept 70mm faceplates. No additional mounting hardware required.	Off White	1	10
T70L4IW	Snap-on horizontal communication faceplate designed to accept four SYSTIMAX* communication modules (not included). Can be used with PANDUIT surface raceway systems and boxes that accept 70mm faceplates. No additional mounting hardware required.	Off White	1	10
T70LV2IW	Snap-on vertical communication faceplate designed to accept two SYSTIMAX* communication modules (not included). Can be used with PANDUIT surface raceway systems and boxes that accept 70mm faceplates. No additional mounting hardware required.	Off White	1	10
T70LV4IW	Snap-on vertical communication faceplate designed to accept four SYSTIMAX* communication modules (not included). Can be used with PANDUIT surface raceway systems and boxes that accept 70mm faceplates. No additional mounting hardware required.	Off White	1	10

‡For other colors replace IW (Off White) with EI (Electric Ivory), IG (International Gray), or WH (White).

*SYSTIMAX is a registered trademark of Commscope, Inc.

For complete labeling solutions, reference chart below.

Component Labels for PAN-WAY® Snap-On Faceplates for use with SYSTIMAX* Communication Modules

Faceplate Part Number	Suggested Label Solutions for TIA/EIA-606-A Compliance		
	Laser/Ink Jet Desktop Printer Label	PANTHER™ LS8E Hand-Held Printer Label	COUGAR™ LS9 Hand-Held Printer Label
T70L2IW T70LV2IW	C125X030FJJ	C125X030FJC	T031X000FJC-BK
T70LV4IW	2-C125X030FJJ	2-C125X030FJC	
T70L4IW	C261X030FJJ	C125X030FJC	

*SYSTIMAX is a registered trademark of Commscope, Inc.

A. System Overview

B1. Cable Ties

B2. Cable Accessories

B3. Stainless Steel Ties

C1. Wiring Duct

C2. Surface Raceway

C3. Abrasion Protection

C4. Cable Management

D1. Terminals

D2. Power Connectors

D3. Grounding Connectors

E1. Labeling Systems

E2. Labels

E3. Pre-Printed & Write-On Markers

E4. Permanent Identification

E5. Lockout/Tagout & Safety Solutions

F. Index

A. System Overview



PAN-WAY® Snap-On Faceplates for Nordx/CDT* Communication Modules

B1. Cable Ties

- Can be used with *PAN-WAY*® Cove, TG-70, T70, Twin-70, T-45 Raceway Systems, *FAST-SNAP*™ Outlet Boxes, and *PAN-POLE*™ Aluminum Outlet Poles

B2. Cable Accessories



T70N2

B3. Stainless Steel Ties



T70N4

C1. Wiring Duct

C2. Surface Raceway



T70NV2

C3. Abrasion Protection

C4. Cable Management



T70NV4

D1. Terminals

D2. Power Connectors

D3. Grounding Connectors

E1. Labeling Systems

E2. Labels

E3. Pre-Printed & Write-On Markers

E4. Permanent Identification

E5. Lockout/Tagout & Safety Solutions

F. Index

Part Number	Part Description	Color‡	Std. Pkg. Qty.	Std. Ctn. Qty.
T70N2IW	Snap-on horizontal communication faceplate designed to accept two Nordx/CDT* communication modules (not included). Can be used with <i>PANDUIT</i> surface raceway systems and boxes that accept 70mm faceplates. No additional mounting hardware required.	Off White	1	10
T70N4IW	Snap-on horizontal communication faceplate designed to accept four Nordx/CDT* communication modules (not included). Can be used with <i>PANDUIT</i> surface raceway systems and boxes that accept 70mm faceplates. No additional mounting hardware required.	Off White	1	10
T70NV2IW	Snap-on vertical communication faceplate designed to accept two Nordx/CDT* communication modules (not included). Can be used with <i>PANDUIT</i> surface raceway systems and boxes that accept 70mm faceplates. No additional mounting hardware required.	Off White	1	10
T70NV4IW	Snap-on vertical communication faceplate designed to accept two Nordx/CDT* communication modules (not included). Can be used with <i>PANDUIT</i> surface raceway systems and boxes that accept 70mm faceplates. No additional mounting hardware required.	Off White	1	10

‡For other colors replace IW (Off White) with EI (Electric Ivory).

*Nordx/CDT is a registered trademark of Nordx/CDT, Inc.

For complete labeling solutions, reference chart below.

Component Labels for *PAN-WAY*® Snap-On Faceplates for use with Nordx/CDT* Communication Modules

Suggested Label Solutions for TIA/EIA-606-A Compliance			
Faceplate Part Number	Laser/Ink Jet Desktop Printer Label	<i>PANTHER</i> ™ LS8E Hand-Held Printer Label	<i>COUGAR</i> ™ LS9 Hand-Held Printer Label
T70N2IW T70NV2IW	C125X030FJJ	C125X030FJC	T031X000FJC-BK
T70NV4IW	2-C125X030FJJ	2-C125X030FJC	
T70N4IW	C261X030FJJ	C125X030FJC	

*Nordx/CDT is a registered trademark of Nordx/CDT, Inc.

For complete labeling solutions, reference charts on pages E2.4 and E2.5.



PAN-WAY® Low Voltage Surface Mount Outlet Boxes

- JBX3510 assembles without the use of screws for faster installation
- JB1 and JB1D are a one-piece design requiring no assembly
- JBX3510, JB1, and JB1D are supplied with adhesive backing to speed installation



JBX3510-A**



JB1-A**



JB1D-A**



JBP2

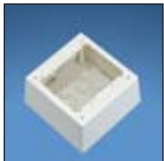

JBP2D



RJBX3510



JBA-X



JB1FS-A**

Part Number	Part Description	Color‡	Std. Pkg. Qty.	Std. Ctn. Qty.
JBX3510IW-A	Single gang two-piece snap together outlet box with adhesive backing. Box accepts PAN-WAY® Screw-On Faceplates or any NEMA standard single gang faceplate. For use with PAN-WAY® T45 or LD profile raceway. 5.00"L x 3.26"W x 1.62"H (127.1mm x 82.7mm x 41.1mm). Breakouts for 1/2", 3/4", or 1" diameter conduit.	Off White	1	10
JB1IW-A	Single gang one-piece outlet box with adhesive backing. Box accepts PAN-WAY® Screw-On Faceplates or any NEMA standard single gang faceplate. For use with PAN-WAY® LD profile raceway. 5.09"L x 3.34"W x 1.75"H (129.4mm x 85.0mm x 44.4mm). Breakouts for 1/2", 3/4", or 1" diameter conduit.	Off White	1	10
JB1DIW-A	Single gang one-piece deep outlet box with adhesive backing. Box accepts PAN-WAY® Screw-On Faceplates or any NEMA standard single gang faceplate. For use with PAN-WAY® LD profile raceway. 5.23"L x 3.48"W x 2.75"H (133.0mm x 88.5mm x 69.8mm). Breakouts for 1/2", 3/4", or 1" diameter conduit.	Off White	1	10
JBP2IW	Double gang two-piece screw together outlet box. Box accepts PAN-WAY® Screw-On Faceplates or any NEMA standard double gang faceplates. For use with PAN-WAY® LD profile raceway. 5.05" L x 5.05" W x 1.62"H (128.2mm x 128.2mm x 41.1mm). Breakouts for 1/2" or 3/4" diameter conduit.	Off White	1	10
JBP2DIW	Double gang two-piece screw together deep outlet box. Box accepts PAN-WAY® Screw-On Faceplates or any NEMA standard double gang faceplate. For use with PAN-WAY® T-45 or LD profile raceway. 5.19"L x 5.19"W x 2.75"H (131.9mm x 131.9mm x 69.8mm). Breakouts for 3/4" or 1" diameter conduit.	Off White	1	10
RJBX3510IW	Single gang two-piece screw together round outlet box. Box accepts UL/CSA devices not to exceed 10 lbs. (5 lbs. per CSA). For use with PAN-WAY® LD profile raceway. Dia. = 5.48"D x 1.14"H (139.2mm x 29.0mm). Breakouts for 3/4" or 1" diameter conduit.	Off White	1	5
JBA-X	In-wall box adapter. Adapts single gang surface mount outlet boxes to in-wall conduit boxes.	—	10	100
JB1FSIW-A	Single gang two-piece snap together outlet box with adhesive backing. Box accepts PAN-WAY® Snap-On Faceplates. For use with PAN-WAY® T-45 or LD profile raceway. 5.00"L x 3.26"W x 1.62"H (127.1mm x 82.7mm x 41.1mm). Breakouts for 1/2", 3/4", or 1" diameter conduit.	Off White	1	10

‡For other colors replace IW (Off White) with EI (Electric Ivory), IG (International Gray), or WH (White).

A. System Overview

B1. Cable Ties

B2. Cable Accessories

B3. Stainless Steel Ties

C1. Wiring Duct

C2. Surface Raceway

C3. Abrasion Protection

C4. Cable Management

D1. Terminals

D2. Power Connectors

D3. Grounding Connectors

E1. Labeling Systems

E2. Labels

E3. Pre-Printed & Write-On Markers

E4. Permanent Identification

E5. Lockout/Tagout & Safety Solutions

F. Index

A. System Overview



PAN-WAY® Power Rated Surface Mount Outlet Boxes

B1. Cable Ties

- JBX3510 assembles without the use of screws for faster installation
- JB1 and JB1D are a one-piece design requiring no assembly
- JBX3510, JB1, and JB1D are supplied with adhesive backing to speed installation

B2. Cable Accessories

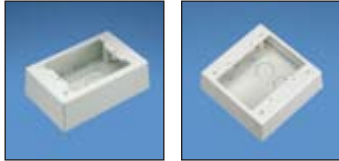

JBP1

JBP2

B3. Stainless Steel Ties

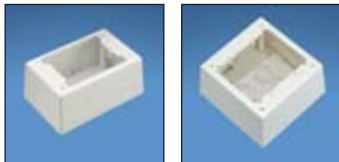

JBP1D

JBP2D

C1. Wiring Duct

C2. Surface Raceway

C3. Abrasion Protection



JBP1E

JBP1I

C4. Cable Management

D1. Terminals



PSJBX

JBD1

D2. Power Connectors

D3. Grounding Connectors



JBP2S

JBD2

E1. Labeling Systems

E2. Labels



JBP2FS

JBP1MR20

E3. Pre-Printed & Write-On Markers

E4. Permanent Identification



JBP1MD20

RJBX3510

E5. Lockout/Tagout & Safety Solutions

F. Index

Part Number	Part Description	Color†	Std. Pkg. Qty.	Std. Ctn. Qty.
JBP1IW	Single gang two-piece screw together outlet box. Box accepts PAN-WAY® Screw-On Faceplates or any NEMA standard single gang faceplate. For use with PAN-WAY® LD profile raceway. 5.19"L x 3.45"W x 1.75"H (131.9mm x 87.7mm x 44.4mm). Breakouts for 1/2", 3/4", or 1" diameter conduit.	Off White	1	10
JBP2IW	Double gang two-piece screw together outlet box. Box accepts PAN-WAY® Screw-On Faceplates or any NEMA standard double gang faceplates. For use with PAN-WAY® LD profile raceway. 5.05"L x 5.05"W x 1.62"H (128.2mm x 128.2mm x 41.1mm). Breakouts for 1/2" or 3/4" diameter conduit.	Off White	1	10
JBP1DIW	Single gang two-piece screw together deep outlet box. Box accepts PAN-WAY® Screw-On Faceplates or any NEMA standard single gang faceplate. For use with PAN-WAY® T-45, LD2P10 (when used with JBD1), or LD profile raceway. 5.19"L x 3.45"W x 2.75"H (131.9mm x 87.7mm x 69.8mm). Breakouts for 1/2", 3/4", or 1" diameter conduit.	Off White	1	10
JBP2DIW	Double gang two-piece screw together deep outlet box. Box accepts PAN-WAY® Screw-On Faceplates or any NEMA standard double gang faceplate. For use with PAN-WAY® T-45 or LD profile raceway. 5.19"L x 5.19"W x 2.75"H (131.9mm x 131.9mm x 69.8mm). Breakouts for 1/2", 3/4", or 1" diameter conduit.	Off White	1	10
JBP1EIW	Single gang two-piece screw together extension outlet box. Box accepts PAN-WAY® Screw-On Faceplates or any NEMA standard single gang faceplate. For use with PAN-WAY® LD profile raceway. 4.99"L x 3.30"W x 1.00"H (126.7mm x 83.8mm x 25.4mm). Breakouts for 1/2", 3/4", or 1" diameter conduit.	Off White	1	10
JBP1IIW	Single gang two-piece screw together intermediate outlet box. Box accepts PAN-WAY® Screw-On Faceplates or any NEMA standard single gang faceplate. For use with PAN-WAY® LD profile raceway. 5.12"L x 3.38"W x 2.27"H (130.2mm x 86.0mm x 57.7mm). Breakouts for 1/2" or 3/4" diameter conduit.	Off White	1	10
PSJBXIW	Single gang two-piece snap together power source box. For use with PAN-WAY® LDPH3, 5, 10, or LDS3, or 5 profile raceway. 5.02"L x 3.32"W x 1.31"H (127.6mm x 83.0mm x 33.3mm). Breakouts for 1/2", 3/4", or 1" diameter conduit.	Off White	1	10
JBD1	Single gang pass-through divider. Allows power and communication outlets to be routed in series. For use with JBP1 or JBP1D when installing LD2P10 raceway.	Off White	1	10
JBP2SIW	Double gang two-piece screw together divided outlet box. Box accepts PAN-WAY® Screw-On Faceplates or any NEMA standard double gang faceplate. For use with PAN-WAY® T-45 or LD profile raceway. 5.05"L x 5.05"W x 1.62"H (128.2mm x 128.2mm x 41.1mm). Breakouts for 1/2" or 3/4" diameter conduit.	Off White	1	10
JBD2	Double gang pass-through divider. Allows power and communication outlets to be routed in series. For use with JBP2D when installing LD2P10 raceway.	Off White	1	10
JBP2FSIW	Double gang power rated two-piece snap together outlet box. Box accepts PAN-WAY® Snap-On Faceplates. For use with PAN-WAY® T-45 or LD profile raceway. 5.00"L x 6.14"W x 1.62"H (127.1mm x 155.9mm x 41.1mm). Breakouts for 1/2", 3/4", or 1" diameter conduit.	Off White	1	10
JBP1MR20IW	Single gang two-piece power rated low profile snap together outlet box. Includes 20 A U.S. style rectangular electrical outlet. For use with PAN-WAY® LDPH3, 5, 10 or LDS3 or 5 profile raceway only. 4.84"L x 2.90"W x 1.20"H (122.9mm x 73.6mm x 30.4mm).	Off White	1	10
JBP1MD20IW	Single gang two-piece power rated low profile snap together outlet box. Includes 20 A U.S. style 106 duplex electrical outlet. For use with PAN-WAY® LDPH3, 5, 10 or LDS3 or 5 profile raceway only. 4.84"L x 2.90"W x 1.22"H (122.9mm x 73.6mm x 30.9mm).	Off White	1	10
RJBX3510IW	Single gang two-piece screw together round outlet box. Box accepts UL/CSA devices not to exceed 10 lbs. (5 lbs. per CSA). For use with PAN-WAY® LD profile raceway. Dia. = 5.48"D x 1.14"H (139.2mm x 29.0mm). Breakouts for 3/4" or 1" diameter conduit.	Off White	1	5

†For other colors replace IW (Off White) with EI (Electric Ivory), IG (International Gray), or WH (White).



PAN-WAY® Classic Series Faceplates for Power and Communication Applications

• For use with JBP2S or JBP2D outlet boxes

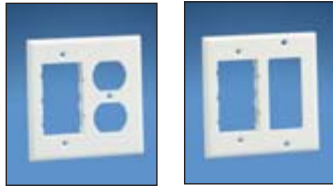

FP2DC

FP2RC

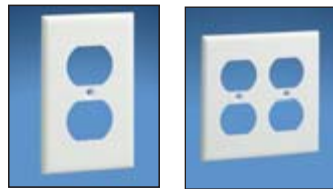

CP106

CP106**-2G

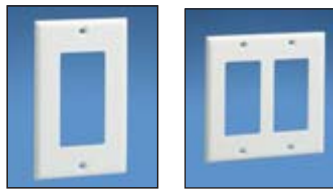

CPGIW

CPGI**-2G



CPN

CPN**-2G

Part Number	Part Description	Color†	Std. Pkg. Qty.	Std. Ctn. Qty.
FP2DCIW	Covers one NEMA standard 106 duplex electrical receptacle and accepts <i>PANDUIT® MINI-COM®</i> 1/2-size, 1/3-size, and 2/3-size Inserts. For product application, please reference LD profile raceway section.	Off White	1	10
FP2RCIW	Covers one NEMA standard rectangular electrical receptacle and accepts <i>PANDUIT® MINI-COM®</i> 1/2-size, 1/3-size, and 2/3-size Inserts. For product application, please reference LD profile raceway section.	Off White	1	10
CP106IW	Screw-on single gang 106 duplex faceplate. Covers one NEMA standard 106 duplex electrical outlet or one standard 106 communication module frame.	Off White	1	10
CP106IW-2G	Screw-on double gang 106 duplex faceplate. Covers two NEMA standard 106 duplex electrical outlets or two standard 106 communication module frames.	Off White	1	10
CPGIW	Screw-on single gang rectangular faceplate. Covers one NEMA standard rectangular electrical outlet or one standard rectangular communication module frame.	Off White	1	10
CPGIW-2G	Screw-on double gang rectangular faceplate. Covers two NEMA standard rectangular electrical outlets or two standard rectangular communication module frames.	Off White	1	10
CPNIW	Screw-on single gang blank cover faceplate. Can be used with <i>PAN-WAY®</i> Cove, TG-70, T-70, Twin-70, T-45 Raceway Systems, <i>FAST-SNAP™</i> Outlet Boxes and <i>PAN-POLE™</i> Aluminum Outlet Pole. Supplied with two mounting screws.	Off White	1	10
CPNIW-2G	Screw-on double gang blank cover faceplate. For use with <i>PAN-WAY®</i> Surface Mount Outlet Boxes. Supplied with four mounting screws.	Off White	1	10

†For other colors replace suffix IW (Off White) with EI (Electric Ivory), IG (International Gray), WH (White), or AL (Almond).

All faceplates supplied with mounting screws.

For complete labeling solutions, reference label chart below.

Component Labels for *PAN-WAY®* Classic Series Faceplates for Power and Communication Applications

Suggested Label Solutions for TIA/EIA-606-A Compliance				
Faceplate Part Number	Laser/Ink Jet Desktop Printer Label	TDP43MY Thermal Transfer Desktop Printer Label	<i>PANTHER™</i> LS8E Hand-Held Printer Label	<i>COUGAR™</i> LS9 Hand-Held Printer Label
CPGIW T70PGS	C125X030FJJ	C125X030YPT	C125X030FJC	T031X000FJC-BK
CPGIW-2G FP2RC	2-C125X030FJJ	2-C125X030YPT	2-C125X030FJC	T031X000FJC-BK
T70PG	C261X030FJJ	T031X000FJT	C261X030FJC	T031X000FJC-BK

A. System Overview

B1. Cable Ties

B2. Cable Accessories

B3. Stainless Steel Ties

C1. Wiring Duct

C2. Surface Raceway

C3. Abrasion Protection

C4. Cable Management

D1. Terminals

D2. Power Connectors

D3. Grounding Connectors

E1. Labeling Systems

E2. Labels

E3. Pre-Printed & Write-On Markers

E4. Permanent Identification

E5. Lockout/Tagout & Safety Solutions

F. Index

A. System Overview

UL **SP** **PAN-WAY® Stainless Steel Faceplates**

B1. Cable Ties



WPS-20

WPS-202

B2. Cable Accessories

B3. Stainless Steel Ties

Part Number	Part Description	Std. Pkg. Qty.	Std. Ctn. Qty.
WPS-20	Stainless steel single gang 106 duplex screw-on faceplate. Covers one NEMA standard 106 duplex electrical outlet or one standard 106 communication module frame.	1	10
WPS-202	Stainless steel double gang 106 duplex screw-on faceplate. Covers two NEMA standard 106 duplex electrical outlets or two standard 106 communication module frames.	1	10

All faceplates supplied with mounting screws.

C1. Wiring Duct

PAN-WAY® Electrical Outlets

C2. Surface Raceway

• Electrical outlets are standard electrical devices that fit into *PAN-WAY®* Outlet Boxes or any NEMA standard outlet boxes

C3. Abrasion Protection

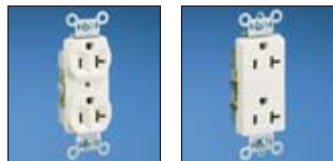

EDU20

ERU20

C4. Cable Management

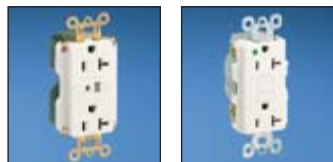

ETU20

EGU20

D1. Terminals

D2. Power Connectors

D3. Grounding Connectors

Part Number	Part Description	Color‡	Std. Pkg. Qty.
EDU20IW-X	20 A specification grade 106 duplex outlet.	Off White	10
ERU20IW-X	20 A specification grade rectangular outlet.	Off White	10
ETU20IW-X	20 A specification grade TVSS rectangular outlet (transient voltage surge suppressor).	Off White	10
EGU20IW-X	20 A specification grade GFCI rectangular outlet (ground fault circuit interrupter).	Off White	10

‡For other colors, replace IW (Off White) with EI (Electric Ivory).
All outlets supplied with mounting screws.

E1. Labeling Systems

UL **SP** **PAN-WAY® Surface Mount Outlet Box with 20 A Electrical Outlet**

• Supplied with a 20 A U.S. style rectangular electrical outlet and a 20A 106 duplex electrical outlet.



JBP1MR20

E2. Labels

E3. Pre-Printed & Write-On Markers

E4. Permanent Identification



JBP1MD20

E5. Lockout/Tagout & Safety Solutions

F. Index

Part Number	Part Description	Color‡	Std. Pkg. Qty.	Std. Ctn. Qty.
JBP1MR20IW	Single gang two-piece power rated low profile snap together outlet box. Includes 20 A U.S. style rectangular electrical outlet. For use with <i>PAN-WAY®</i> LDPH3, 5, 10 or LDS3 or 5 profile raceway only. 4.84"L x 2.90"W x 1.20"H (122.9mm x 73.6mm x 30.4mm).	Off White	1	10
JBP1MD20IW	Single gang two-piece power rated low profile snap together outlet box. Includes 20 A U.S. style 106 duplex electrical outlet. For use with <i>PAN-WAY®</i> LDPH3, 5, 10 or LDS3 or 5 profile raceway only. 4.84"L x 2.90"W x 1.22"H (122.9mm x 73.6mm x 30.9mm).	Off White	1	10

‡For other color replace IW (Off White) with EI (Electric Ivory).

Selection Chart for using *PAN-WAY®* Surface Raceway with *PAN-WAY®* Surface Mount Outlet Boxes

How to use this chart:

1. Locate the desired *PAN-WAY®* Raceway in the left column.
2. Locate the desired *PAN-WAY®* Outlet Box in the top row.
3. Match up the raceway with the outlet box to see if they are compatible (Y = yes, N = no).
4. Select correct surface mount outlet box.

<i>PAN-WAY®</i> Surface Mount Outlet Boxes									
Low Voltage or Fiber Optic ONLY	Power, Low Voltage, or Fiber Optic								
JB1, JB1D JB1FS JBX3510	RJBX3510	JBP1	JBP1D	JBP1E	JBP1J JBP2	JBP2S JBP2D JBP2FS	JBP1MR20 JBP1MD20	PSJBX	
Type LD (Low Voltage, or Fiber Optic ONLY)									
LD3	Y	Y	Y	Y	Y	Y	Y	N	Y
LD5	Y	Y	Y	Y	Y	Y	Y	N	Y
LD10	Y	Y	Y	Y	Y	Y	Y	N	Y
Type LDPH (Power, Low Voltage, or Fiber Optic)									
LDPH3	Y	Y	Y	Y	Y	Y	Y	Y	Y
LDPH5	Y	Y	Y	Y	Y	Y	Y	Y	Y
LDPH10	Y	Y	Y	Y	Y	Y	Y	Y	Y
Type LDS (Power, Low Voltage, or Fiber Optic)									
LDS3	Y	Y	Y	Y	Y	Y	Y	Y	Y
LDS5	Y	Y	Y	Y	Y	Y	Y	Y	Y
Type LD2P10 (Power, Low Voltage, or Fiber Optic)									
LD2P10	N	N	N	Y w/JBD1	N	N	Y	N	N
Type T-45 (Power, Low Voltage, or Fiber Optic)									
T-45	Y (JB1FS and JBX3510)	N	N	Y	N	N	Y	N	N

A.
System
Overview

B1.
Cable Ties

B2.
Cable
Accessories

B3.
Stainless
Steel Ties

C1.
Wiring
Duct

C2.
Surface
Raceway

C3.
Abrasion
Protection

C4.
Cable
Management

D1.
Terminals

D2.
Power
Connectors

D3.
Grounding
Connectors

E1.
Labeling
Systems

E2.
Labels

E3.
Pre-Printed
& Write-On
Markers

E4.
Permanent
Identification

E5.
Lockout/
Tagout/
& Safety
Solutions

F.
Index

A.
System
Overview

B1.
Cable Ties

B2.
Cable
Accessories

B3.
Stainless
Steel Ties

C1.
Wiring
Duct

C2.
Surface
Raceway

C3.
Abrasion
Protection

C4.
Cable
Management

D1.
Terminals

D2.
Power
Connectors

D3.
Grounding
Connectors

E1.
Labeling
Systems

E2.
Labels

E3.
Pre-Printed
& Write-On
Markers

E4.
Permanent
Identification

E5.
Lockout/
Tagout/
& Safety
Solutions

F.
Index

NOTES

PAN-WAY® LD PROFILE NON-METALLIC SURFACE RACEWAY

PAN-WAY® LD Profile Raceway is available in single and multi-channel styles to provide a solution for routing copper, fiber optic, and power cabling along fixed perimeter walls.



- LD2P10 features one-piece multi-channel design for both power and data applications
- LDPH is a tamper resistant two-piece latching surface raceway supplied with pre-applied adhesive backed tape
- LD features one-piece single channel design for data routing
- LDS features one-piece single channel tamper resistant design with maximum security for power OR data applications

PAN-WAY® LD Profile Raceways include a full complement of fittings for standard, bend radius control, power rated and multi-channel use, and transition easily to other *PANDUIT* raceway such as Cove, TG-70, T-70, Twin-70 and T-45.

A.
System
Overview

B1.
Cable Ties

B2.
Cable
Accessories

B3.
Stainless
Steel Ties

C1.
Wiring
Duct

C2.
Surface
Raceway

C3.
Abrasion
Protection

C4.
Cable
Management

D1.
Terminals

D2.
Power
Connectors

D3.
Grounding
Connectors

E1.
Labeling
Systems

E2.
Labels

E3.
Pre-Printed
& Write-On
Markers

E4.
Permanent
Identification

E5.
Lockout/
Tagout
& Safety
Solutions

F.
Index

A.
System
Overview

LD2P10 Profile Raceway Roadmap

B1.
Cable Ties

B2.
Cable
Accessories

B3.
Stainless
Steel Ties

C1.
Wiring
Duct

C2.
Surface
Raceway

C3.
Abrasion
Protection

C4.
Cable
Management

D1.
Terminals

D2.
Power
Connectors

D3.
Grounding
Connectors

E1.
Labeling
Systems

E2.
Labels

E3.
Pre-Printed
& Write-On
Markers

E4.
Permanent
Identification

E5.
Lockout/
Tagout/
& Safety
Solutions

F.
Index

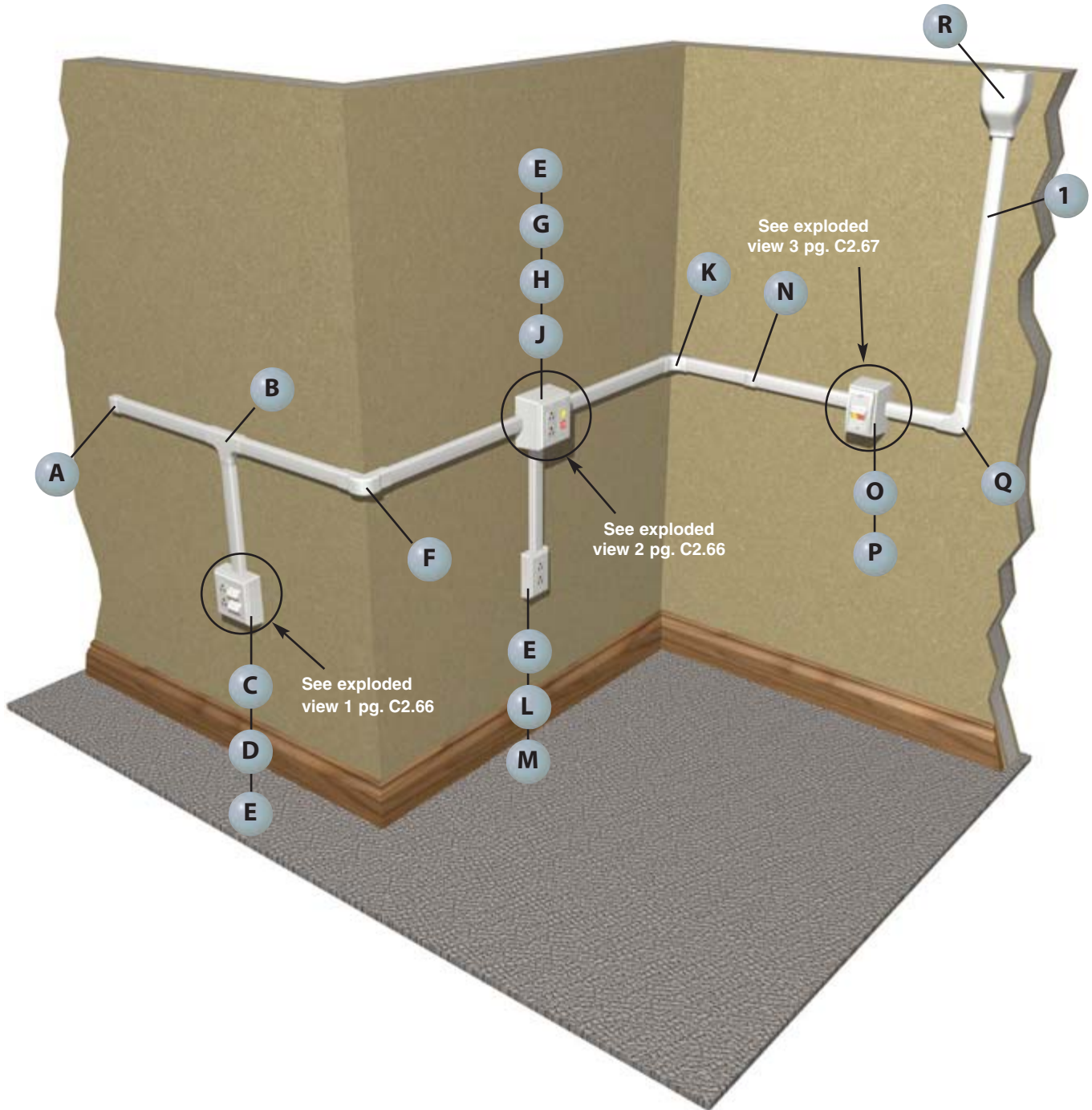

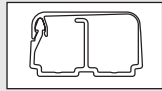

1 LD2P10 – Raceway (page C2.75)

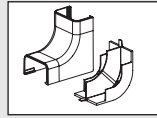

K ICFX10** – Power Rated Inside Corner Fitting (page C2.75)

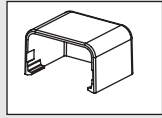

A ECFX10** – Power Rated End Cap Fitting (page C2.75)

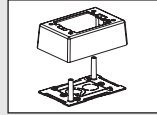

L JBP1** – Power Rated Single Gang Two-Piece Box (page C2.58)

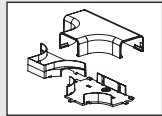

B TFXD10** – 1 Inch Bend Radius Tee Fitting (page C2.75)

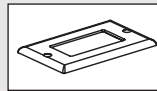

M CPG** – Single Gang Rectangular Screw-On Faceplate (page C2.59)

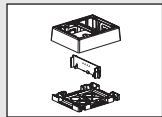

C JBP2S** – Power Rated Double Gang Three-Piece Divided Box (page C2.58)

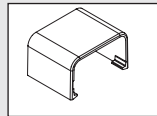

N CFX10** – Power Rated Coupler Fitting (page C2.75)

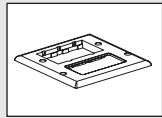

D FP2RC** – Double Gang Rectangular Electrical and Two Communication Insert Faceplate (page C2.59)

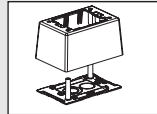

O JBP1D** – Single Gang Two-Piece Deep Box (page C2.58)

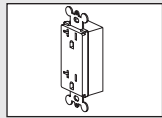

E ERU20** – 20 A Rectangular Electrical Outlet (page C2.60)

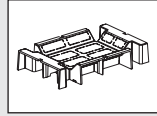

P JBD1 – Single Gang Pass Through Divider for LD2P10 Raceway (page C2.58)

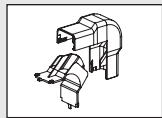

F OCFX10** – 1 Inch Bend Radius Outside Corner Fitting (page C2.75)

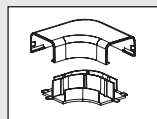

Q RAFX10** – Power Rated Right Angle Fitting (page C2.75)

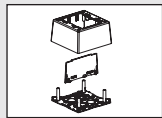

G JBP2D** – Power Rated Double Gang Two-Piece Deep Box (page C2.58)

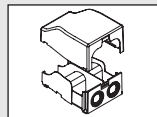

R EEFX** – Power Rated/1 Inch Bend Radius Entrance End Fitting (page C2.75)

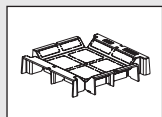

H JBD2 – Double Gang Pass Through and Divider for LD2P10 Raceway (page C2.58)

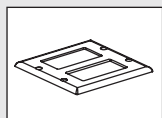

J CPG**-2G – Double Gang Rectangular Screw-On Faceplate (page C2.59)

A. System Overview

B1. Cable Ties

B2. Cable Accessories

B3. Stainless Steel Ties

C1. Wiring Duct

C2. Surface Raceway

C3. Abrasion Protection

C4. Cable Management

D1. Terminals

D2. Power Connectors

D3. Grounding Connectors

E1. Labeling Systems

E2. Labels

E3. Pre-Printed & Write-On Markers

E4. Permanent Identification

E5. Lockout/Tagout & Safety Solutions

F. Index

A.
System
Overview

LD2P10 Configurations

B1.
Cable Ties

Exploded View 1

	Components Required	See page
A.	PANDUIT® <i>MINI-COM</i> ® Modules.	—
B.	FP2RC = Double gang rectangular electrical and two communication insert faceplate (screws included).	C2.61
C.	ERU20 = 20 A rectangular electrical outlet (screws included).	C2.62
D.	JBP2S = Power rated double gang three-piece divided box (screws included).	C2.60

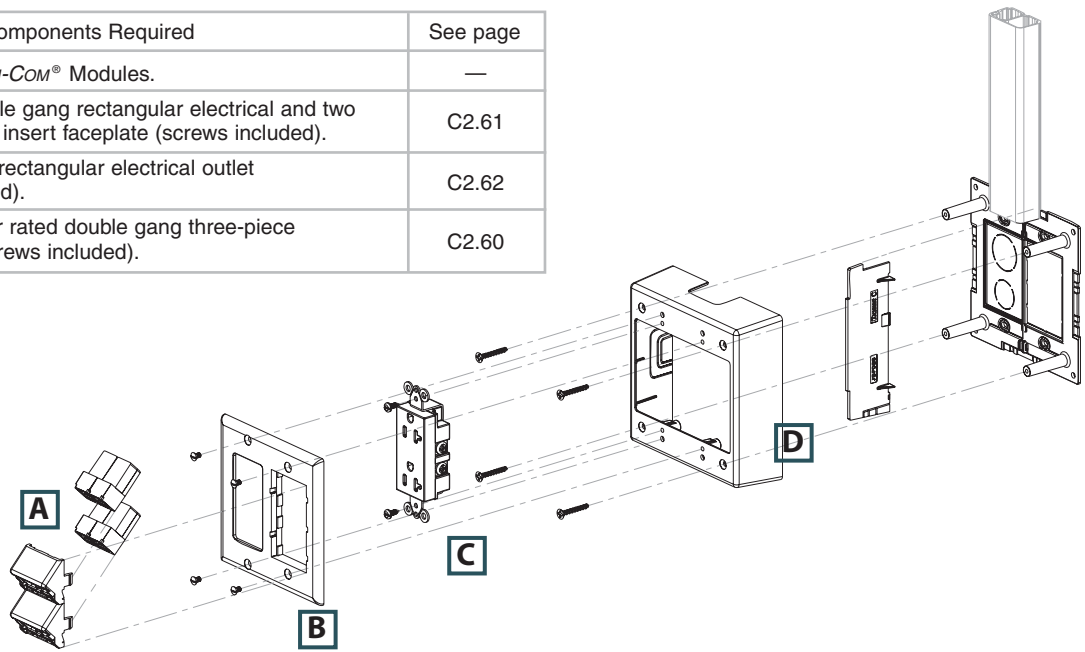

C1.
Wiring
Duct

C2.
Surface
Raceway

C3.
Abrasion
Protection

C4.
Cable
Management

D1.
Terminals

Exploded View 2

	Components Required	See page
A.	JBD2 = Double gang pass-through divider for LD2P10 raceway.	C2.58
B.	JBP2D = Power rated double gang two-piece deep box.	C2.58
C.	ERU20 = 20 A rectangular electrical outlet (screws included).	C2.60
D.	PANDUIT® <i>MINI-COM</i> ® Modules.	—
E.	CPG2G = Double gang rectangular screw-on faceplate (screws included).	C2.59

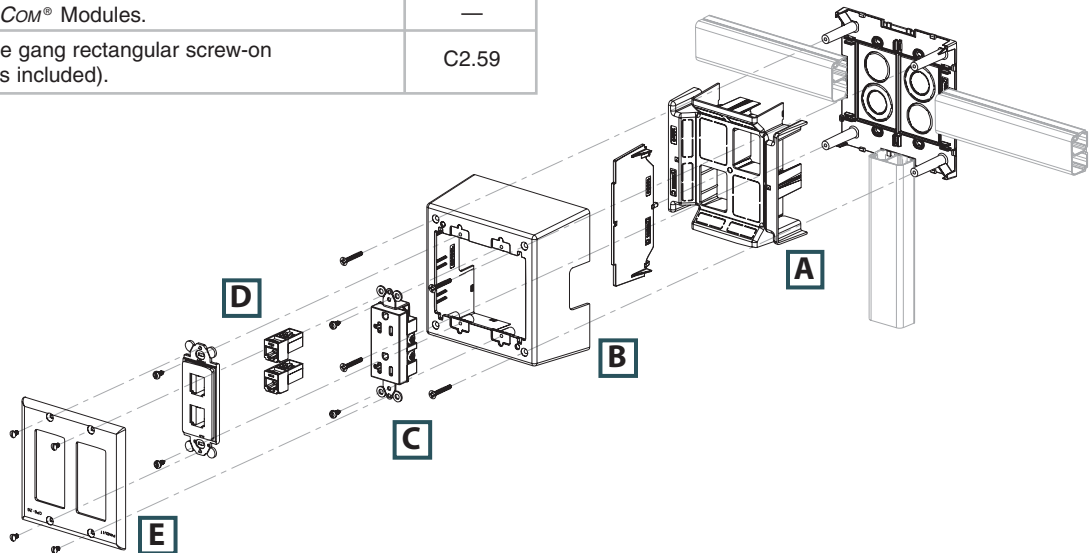

E2.
Labels

E3.
Pre-Printed
& Write-On
Markers

E4.
Permanent
Identification

E5.
Lockout/
Tagout
& Safety
Solutions

F.
Index

LD2P10 Configurations (continued)

Exploded View 3

	Components Required	See page
A.	UICFPSE2 = <i>ULTIMATE ID</i> ® Two-Position Executive Sloped Faceplate.	—
B.	<i>MINI-COM</i> ® Modules.	—
C.	JBP1D = Power rated single gang two-piece deep box (screws included).	C2.58
D.	JBD1 = Single gang pass-through divider for LD2P10 raceway.	C2.58

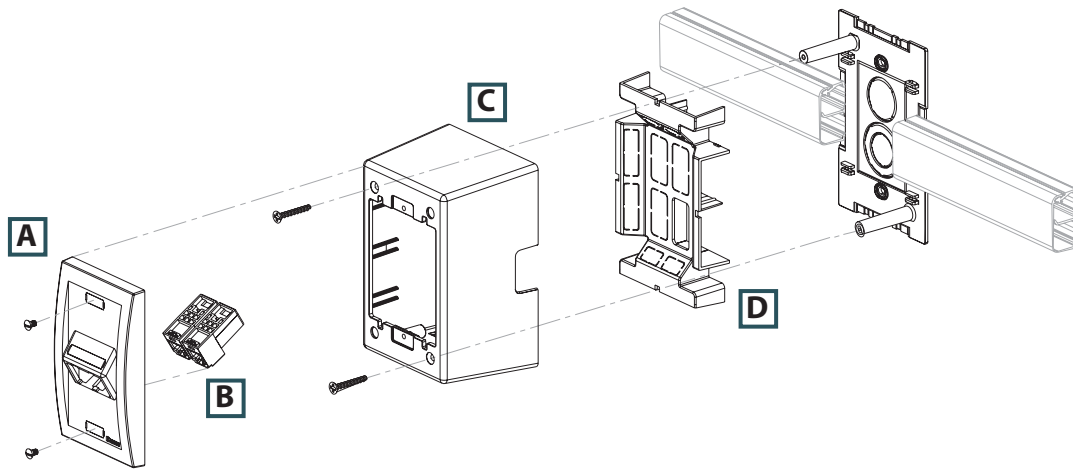

A.
System
Overview

B1.
Cable Ties

B2.
Cable
Accessories

B3.
Stainless
Steel Ties

C1.
Wiring
Duct

C2.
Surface
Raceway

C3.
Abrasion
Protection

C4.
Cable
Management

D1.
Terminals

D2.
Power
Connectors

D3.
Grounding
Connectors

E1.
Labeling
Systems

E2.
Labels

E3.
Pre-Printed
& Write-On
Markers

E4.
Permanent
Identification

E5.
Lockout/
Tagout/
& Safety
Solutions

F.
Index

A.
System
Overview

LD Profile Raceway Roadmap

B1.
Cable Ties

B2.
Cable
Accessories

B3.
Stainless
Steel Ties

C1.
Wiring
Duct

C2.
Surface
Raceway

C3.
Abrasion
Protection

C4.
Cable
Management

D1.
Terminals

D2.
Power
Connectors

D3.
Grounding
Connectors

E1.
Labeling
Systems

E2.
Labels

E3.
Pre-Printed
& Write-On
Markers

E4.
Permanent
Identification

E5.
Lockout/
Tagout/
& Safety
Solutions

F.
Index

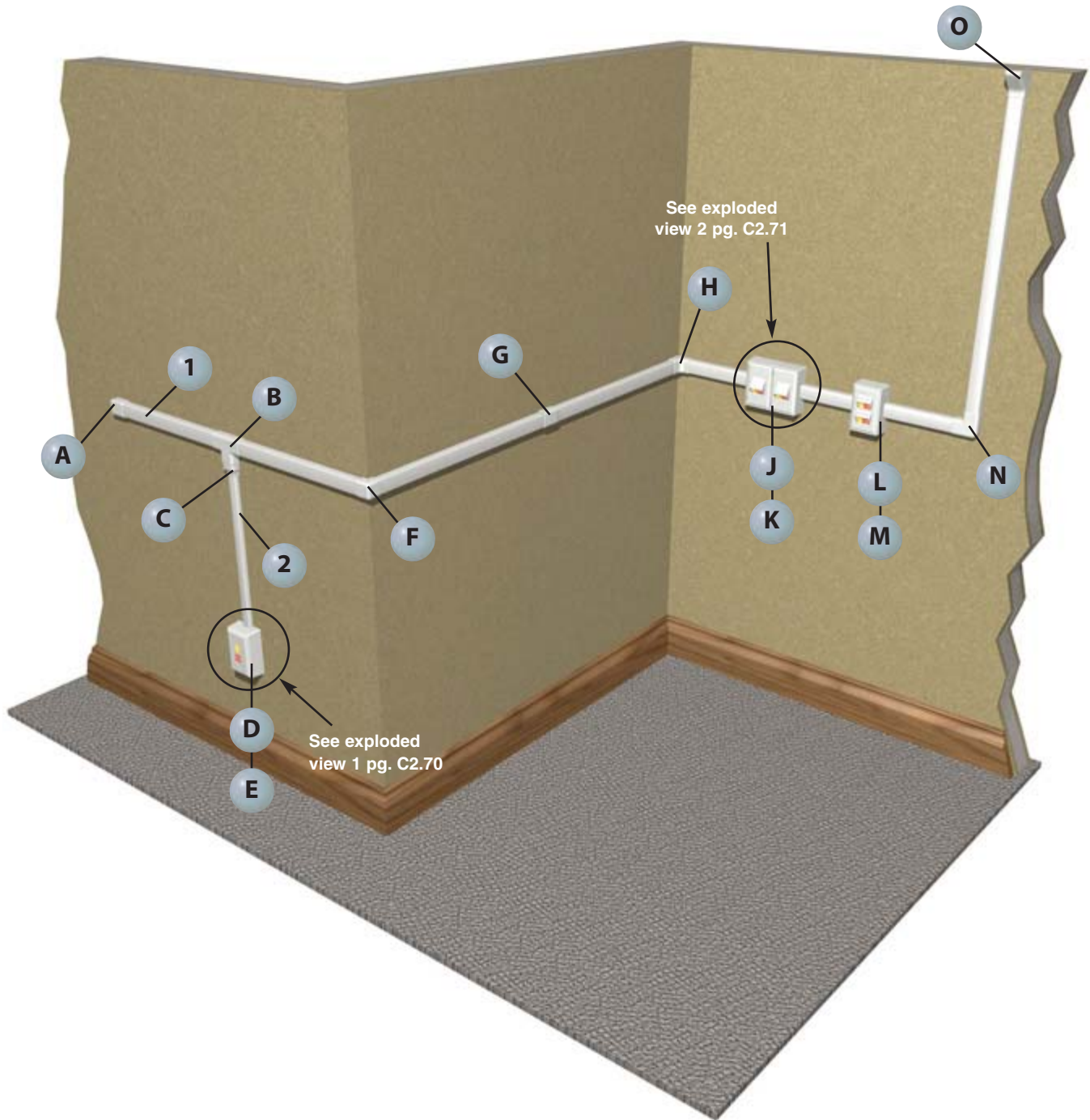

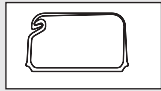

1 LD10 – Raceway (page C2.76)

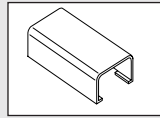

G CF10** – Coupler Fitting (page C2.79)



2 LD5 – Raceway (page C2.76)

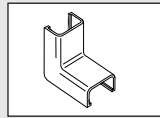

H ICF10** – Inside Corner Fitting (page C2.79)

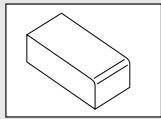

A ECF10** – End Cap Fitting (page C2.79)

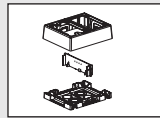

J JBP2FS** – *FAST-SNAP*™ Double Gang Power Rated Surface Mount Outlet Box (page C2.52)

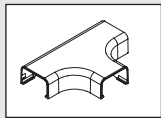

B TF10** – Tee Fitting (page C2.79)

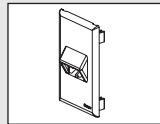

K T70FV2** – Snap-On Vertical Sloped Communication Faceplate (page C2.52)

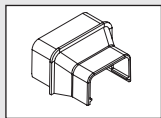

C RF10X5** – Reducer Fitting (page C2.79)

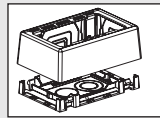

L JB1FS** – *FAST-SNAP*™ Single Gang Surface Mount Outlet Box (page C2.52)

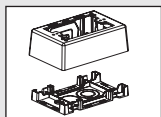

D JBX3510** – Single Gang Two-Piece Snap-Together Box (page C2.57)

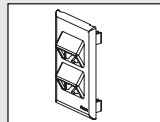

M T70FV4** – Snap-On Vertical Sloped Communication Faceplate (page C2.52)

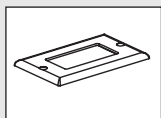

E CPG** – Single Gang Rectangular Screw-On Faceplate (page C2.59)

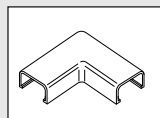

N RAF10** – Right Angle Fitting (page C2.79)

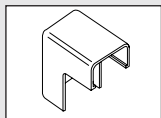

F OCF10** – Outside Corner Fitting (page C2.79)

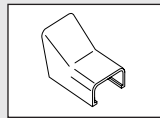

O DCF10** – Drop Ceiling/Entrance End Fitting (page C2.79)

A. System Overview

B1. Cable Ties

B2. Cable Accessories

B3. Stainless Steel Ties

C1. Wiring Duct

C2. Surface Raceway

C3. Abrasion Protection

C4. Cable Management

D1. Terminals

D2. Power Connectors

D3. Grounding Connectors

E1. Labeling Systems

E2. Labels

E3. Pre-Printed & Write-On Markers

E4. Permanent Identification

E5. Lockout/Tagout & Safety Solutions

F. Index

A.
System
Overview

LD Configurations

B1.
Cable Ties

Exploded View 1

B2.
Cable
Accessories

	Components Required	See page
A.	CPG = Single gang rectangular screw-on faceplate (screws included).	C2.59
B.	CFG2 = <i>MINI-COM</i> ® Module Frame – 2-port.	—
C.	<i>MINI-COM</i> ® Modules.	—
D.	JBX3510 = Single gang two-piece snap together box.	C2.57

B3.
Stainless
Steel Ties

C1.
Wiring
Duct

C2.
Surface
Raceway

C3.
Abrasion
Protection

C4.
Cable
Management

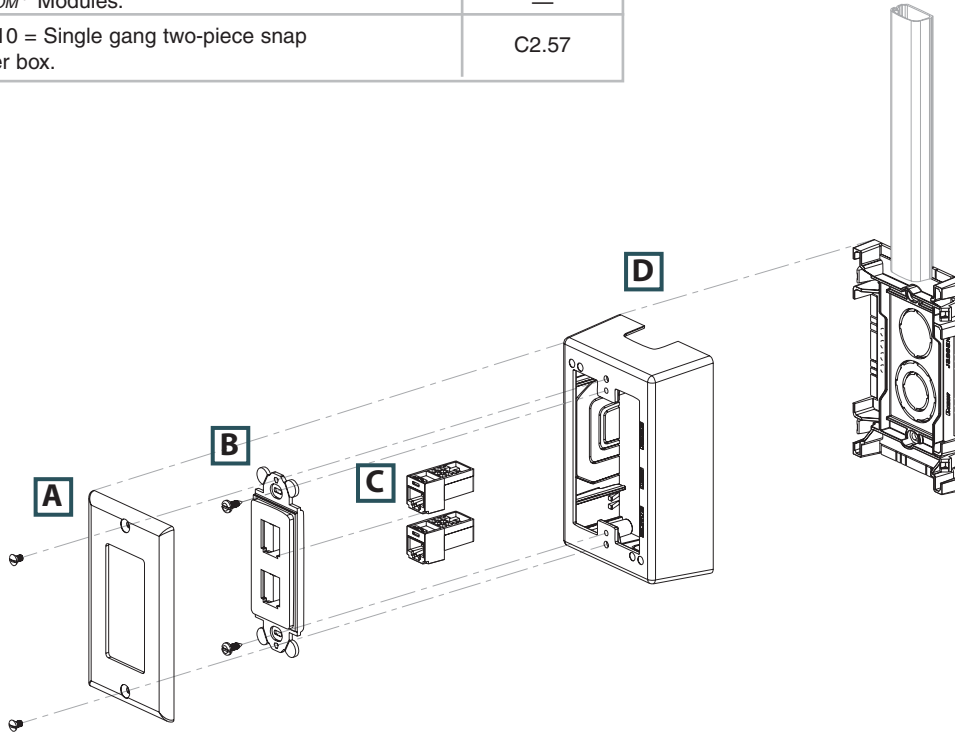

D1.
Terminals

D2.
Power
Connectors

D3.
Grounding
Connectors

E1.
Labeling
Systems

E2.
Labels

E3.
Pre-Printed
& Write-On
Markers

E4.
Permanent
Identification

E5.
Lockout/
Tagout/
& Safety
Solutions

F.
Index

LD Configurations (continued)

Exploded View 2

	Components Required	See page
A.	T70FV2 = Snap-on vertical sloped communication faceplate – 2-port.	C2.52
B.	PANDUIT® MINI-COM® Modules.	—
C.	JBP2FS = FAST-SNAP™ double gang power rated surface mount outlet box.	C2.52

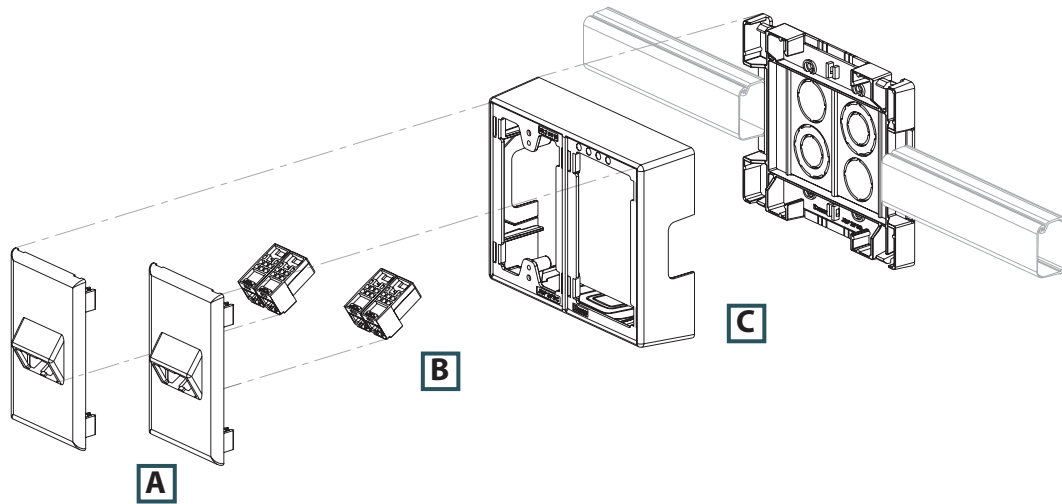

A.
System
Overview

B1.
Cable Ties

B2.
Cable
Accessories

B3.
Stainless
Steel Ties

C1.
Wiring
Duct

C2.
Surface
Raceway

C3.
Abrasion
Protection

C4.
Cable
Management

D1.
Terminals

D2.
Power
Connectors

D3.
Grounding
Connectors

E1.
Labeling
Systems

E2.
Labels

E3.
Pre-Printed
& Write-On
Markers

E4.
Permanent
Identification

E5.
Lockout/
Tagout/
& Safety
Solutions

F.
Index

A.
System
Overview

LDPH Profile Raceway Roadmap

B1.
Cable Ties

B2.
Cable
Accessories

B3.
Stainless
Steel Ties

C1.
Wiring
Duct

C2.
Surface
Raceway

C3.
Abrasion
Protection

C4.
Cable
Management

D1.
Terminals

D2.
Power
Connectors

D3.
Grounding
Connectors

E1.
Labeling
Systems

E2.
Labels

E3.
Pre-Printed
& Write-On
Markers

E4.
Permanent
Identification

E5.
Lockout/
Tagout/
& Safety
Solutions

F.
Index

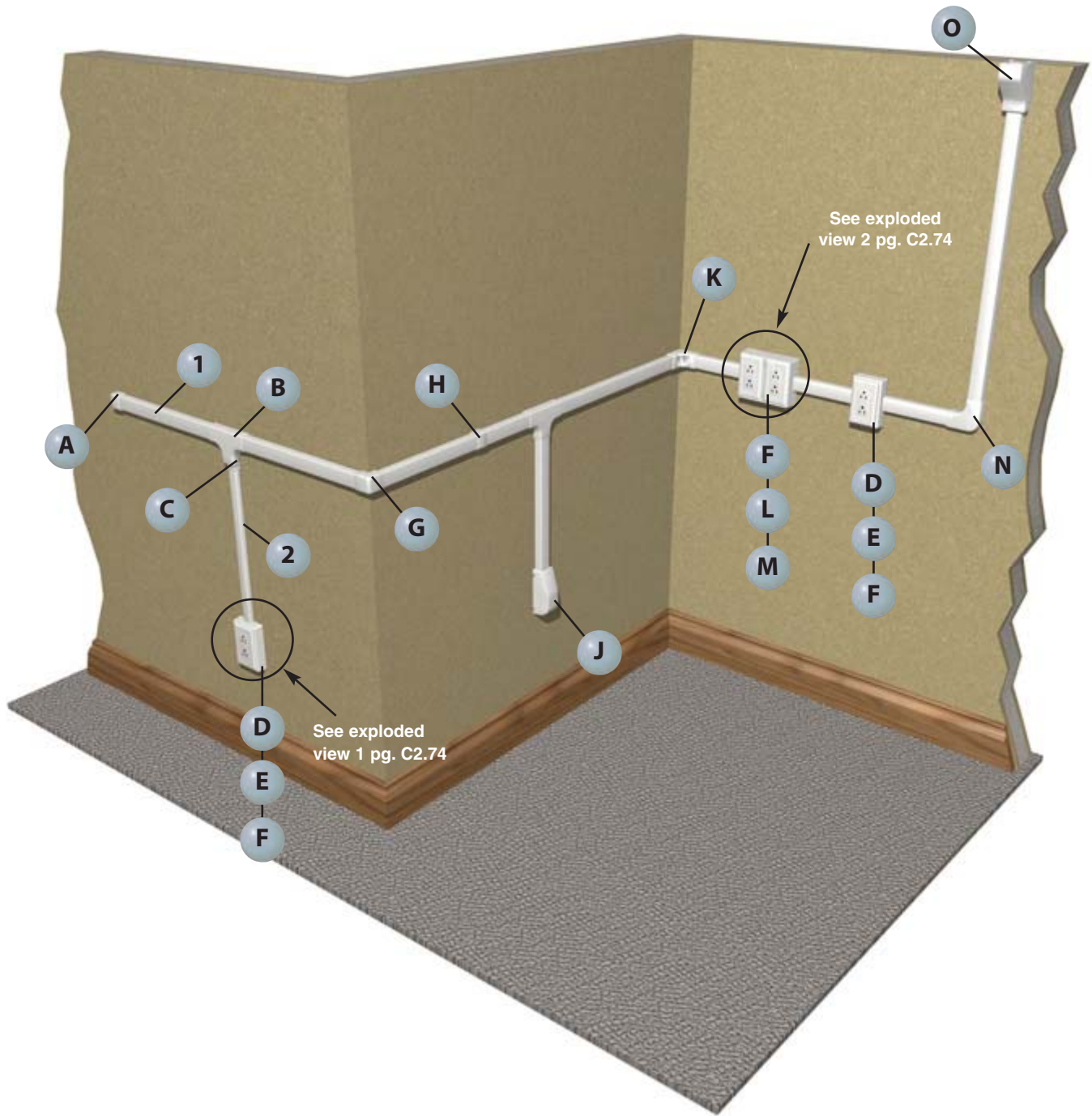

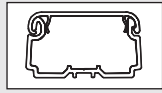

1 LDPH10 – Raceway (page C2.77)

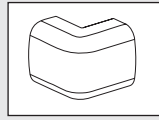

G OCFC10** – Power Rated Outside Corner Fitting (page C2.81)

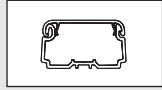

2 LDPH5 – Raceway (page C2.77)

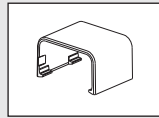

H CFX10** – Power Rated/1 Inch Bend Radius Coupler Fitting (page C2.80)

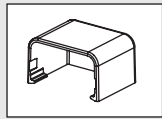

A ECFX10** – Power Rated/1 Inch Bend Radius End Cap Fitting (page C2.80)

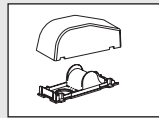

J RAEFX** – Power Rated/1 Inch Bend Radius Right Angle Entrance End Fitting (page C2.81)

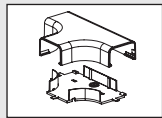

B TFX10** – Power Rated/1 Inch Bend Radius Tee Fitting (page C2.80)

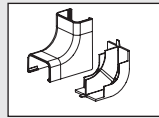

K ICFX10** – Power Rated Inside Corner Fitting (page C2.81)

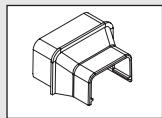

C RFX105** – Power Rated/1 Inch Bend Radius Reducer Fitting (page C2.80)

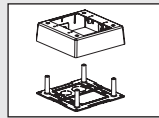

L JBP2** – Power Rated Double Gang Two-Piece Box (page C2.57)

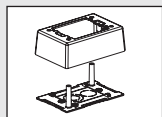

D JBP1** – Power Rated Single Gang Two-Piece Box (page C2.58)

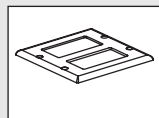

M CPG**-2G – Double Gang Rectangular Screw-On Faceplates (page C2.59)

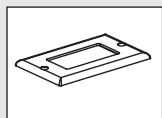

E CPG** – Single Gang Rectangular Screw-On Faceplate (page C2.59)

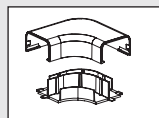

N RAFX10** – Power Rated Right Angle Fitting (page C2.81)

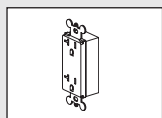

F ERU20** – 20 A Rectangular Electrical Outlet (page C2.60)

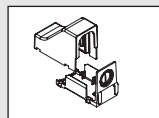

O DCEFX** – Power Rated/1 Inch Bend Radius Drop Ceiling Entrance End Fitting (page C2.80)

A. System Overview

B1. Cable Ties

B2. Cable Accessories

B3. Stainless Steel Ties

C1. Wiring Duct

C2. Surface Raceway

C3. Abrasion Protection

C4. Cable Management

D1. Terminals

D2. Power Connectors

D3. Grounding Connectors

E1. Labeling Systems

E2. Labels

E3. Pre-Printed & Write-On Markers

E4. Permanent Identification

E5. Lockout/Tagout & Safety Solutions

F. Index

A.
System
Overview

LDPH Configurations

B1.
Cable Ties

Exploded View 1

	Components Required	See page
A.	CPG = Single gang rectangular screw-on faceplate (screws included).	C2.59
B.	ERU20 = 20 A rectangular electrical outlet (screws included).	C2.60
C.	JBP1 = Power rated single gang two-piece box (screws included).	C2.58

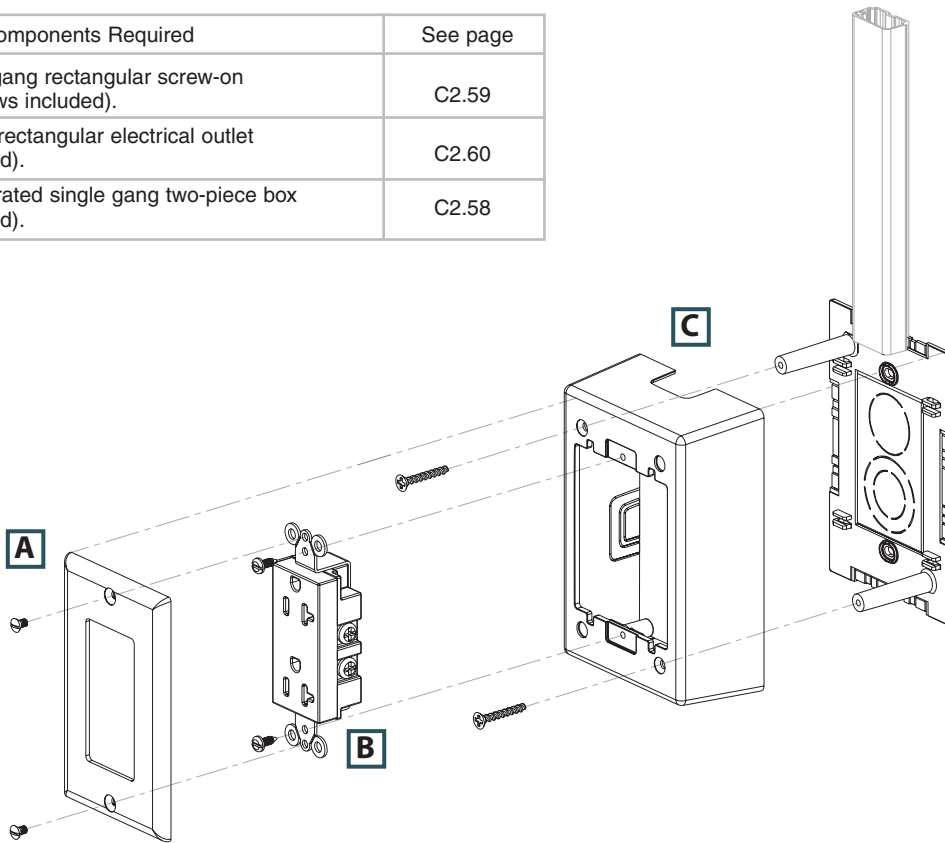

C1.
Wiring
Duct

C2.
Surface
Raceway

C3.
Abrasion
Protection

C4.
Cable
Management

D1.
Terminals

D2.
Power
Connectors

Exploded View 2

	Components Required	See page
A.	CPG**2G = Double gang rectangular screw-on faceplate (screws included).	C2.59
B.	ERU20 = 20 A rectangular electrical outlet (screws included).	C2.60
C.	JBP2 = Power rated double gang three-piece box (screws included).	C2.58

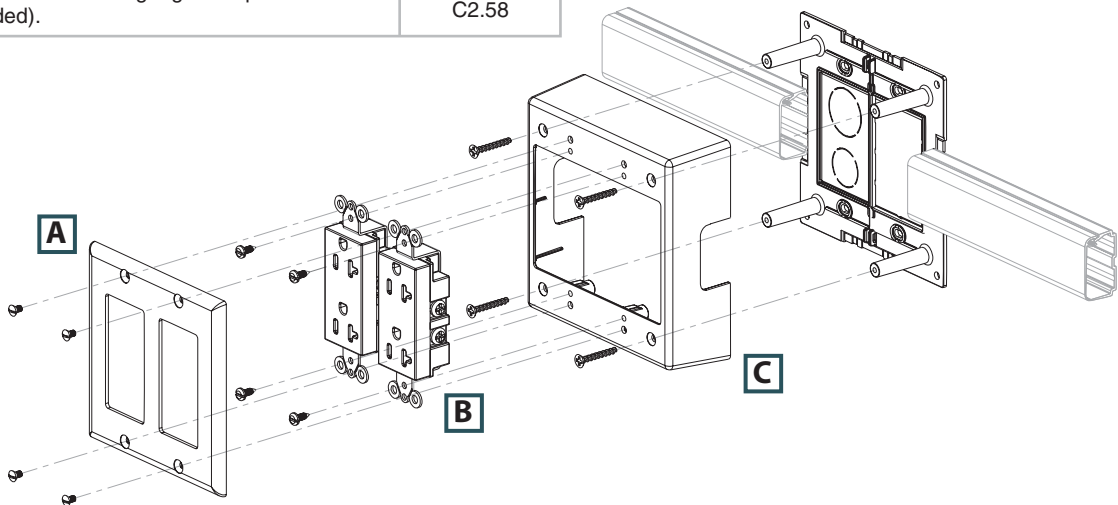

D3.
Grounding
Connectors

E1.
Labeling
Systems

E2.
Labels

E3.
Pre-Printed
& Write-On
Markers

E4.
Permanent
Identification

E5.
Lockout/
Tagout/
& Safety
Solutions

F.
Index



PAN-WAY® Type LD2P10 Multi-Channel Surface Raceway System

- UL and CSA rated 600 V; meets UL 5A and CSA C22.2 No. 62.1-03 standards; FT4 rated
- Routes power and data together
- One-piece hinged design allows cables to be laid in
- Tamper resistant

- Factory applied adhesive backing speeds installation
- Terminates using JBP1D, JBP2D, JBP2FS or JBP2S surface mount outlet box solutions

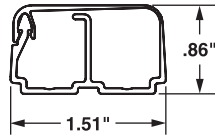

Left Internal Area = .43 Sq. In.
Right Internal Area = .50 Sq. In.



Part Number	Part Description	Raceway Size	Color‡	Length (Ft.)	Std. Ctn. Qty.
LD2P10IW8-A	Two channel tamper resistant one-piece latching surface raceway. Supplied with pre-applied adhesive backed tape. Available in 8' and 10' lengths.	1.52" x .86"	Off White	8	160
LD2P10IW10-A		(39.0mm x 22.0mm)		10	200

LD2P raceway requires screw mounting if it is being used for power cabling applications. Order number of feet required in multiples of standard length increments.

‡For other colors replace IW (Off White) with EI (Electric Ivory), IG (International Gray), or WH (White).



Multi-Channel Fittings for LD2P10

- Multi-channel fittings for LD2P10 are designed to maintain the TIA/EIA-568-B and 569-B required minimum bend radius for high performance copper and fiber optic cabling systems



Part Number	Part Description	Color‡	Std. Pkg. Qty.
CFX10IW-X	Coupler fitting for use with LD10, LDPH10, and LD2P10 raceway.	Off White	10
RAFX10IW-X	Right angle fitting for use with LDPH10 and LD2P10 raceway.	Off White	10
ICFX10IW-X	Inside corner fitting for use with LDPH10 and LD2P10 raceway.	Off White	10
OCFX10IW-X	Outside corner fitting for use with LDPH10 and LD2P10 raceway.	Off White	10
TFXD10IW-X	Tee fitting with divided insert to maintain separation of power and data cabling. For use with LD2P10 raceway.	Off White	10
ECFX10IW-X	End cap fitting for use with LDPH10 and LD2P10 raceway.	Off White	10
EEFXIW	Entrance end fitting for LD2P10 raceway. Breakouts for 1/2" and 3/4" diameter conduit.	Off White	1

‡For other colors replace IW (Off White) with EI (Electric Ivory), IG (International Gray), or WH (White).

A. System Overview

B1. Cable Ties

B2. Cable Accessories

B3. Stainless Steel Ties

C1. Wiring Duct

C2. Surface Raceway

C3. Abrasion Protection

C4. Cable Management

D1. Terminals

D2. Power Connectors

D3. Grounding Connectors

E1. Labeling Systems

E2. Labels

E3. Pre-Printed & Write-On Markers

E4. Permanent Identification

E5. Lockout/Tagout & Safety Solutions

F. Index

A. System Overview

PAN-WAY® LD Surface Raceway System

B1. Cable Ties

- For routing data and low voltage cabling
- One-piece hinged design allows cables to be laid in
- Factory applied adhesive backing speeds installation

- FT4 rated
- Terminates using surface mount outlet box solutions or *PANDUIT® MINI-COM®* Surface Mount Boxes

B2. Cable Accessories

B3. Stainless Steel Ties

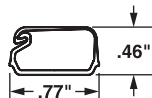

LD3
Internal Area = .21 Sq. In.

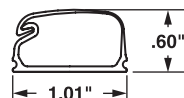

LD5
Internal Area = .38 Sq. In.

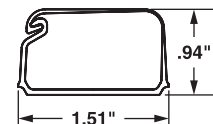

LD10
Internal Area = 1.00 Sq. In.



LD3



LD5



LD10

C1. Wiring Duct

C2. Surface Raceway

C3. Abrasion Protection

C4. Cable Management

D1. Terminals

D2. Power Connectors

D3. Grounding Connectors

E1. Labeling Systems

E2. Labels

E3. Pre-Printed & Write-On Markers

E4. Permanent Identification

E5. Lockout/Tagout & Safety Solutions

F. Index

Part Number	Part Description	Raceway Size	Color‡	Length (Ft.)	Std. Ctn. Qty.
LD3 – Surface Raceway					
LD3IW6-A	One-piece latching surface raceway. Supplied with pre-applied adhesive backed tape. Available in 6', 8', and 10' lengths.	.77" x .46" (20.0mm x 12.0mm)	Off White	6	120
LD3IW8-A				8	160
LD3IW10-A				10	200
LD5 – Surface Raceway					
LD5IW6-A	One-piece latching surface raceway. Supplied with pre-applied adhesive backed tape. Available in 6', 8', and 10' lengths.	1.01" x .58" (26.0mm x 15.0mm)	Off White	6	120
LD5IW8-A				8	160
LD5IW10-A				10	200
LD10 – Surface Raceway					
LD10IW6-A	One-piece latching surface raceway. Supplied with pre-applied adhesive backed tape. Available in 6', 8', and 10' lengths.	1.51" x .94" (38.4mm x 24.0mm)	Off White	6	120
LD10IW8-A				8	160
LD10IW10-A				10	200

‡For other colors replace IW (Off White) with EI (Electric Ivory), IG (International Gray), or WH (White).
Order number of feet required in multiples of standard length increments.

PAN-WAY® LDPH Surface Raceway System

- UL and CSA rated 600 V; meets UL 5A and CSA C22.2 No. 62.1-03 standards; FT4 rated
- Two-piece hinged design allows cables to be laid in
- Tamper resistant

- Factory applied adhesive backing speeds installation
- Terminates using surface mount outlet box solutions or *PANDUIT® MINI-COM®* Surface Mount Boxes

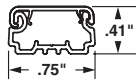

LDPH3
Internal Area = .17 Sq. In.

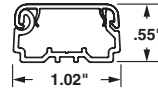

LDPH5
Internal Area = .33 Sq. In.

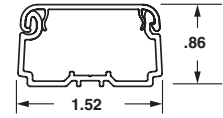

LDPH10
Internal Area = .89 Sq. In.



LDPH3



LDPH5



LDPH10

Part Number	Part Description	Raceway Size	Color‡	Length (Ft.)	Std. Ctn. Qty.
LDPH3 – Surface Raceway					
LDPH3IW8-A	Tamper resistant one-piece latching surface raceway. Supplied with pre-applied adhesive backed tape. Available in 8' and 10' lengths.	.75" x .41" (20.0mm x 10.4mm)	Off White	8	160
LDPH3IW10-A				10	200
LDPH5 – Surface Raceway					
LDPH5IW8-A	Tamper resistant one-piece latching surface raceway. Supplied with pre-applied adhesive backed tape. Available in 8' and 10' lengths.	1.02" x .55" (26.0mm x 14.0mm)	Off White	8	160
LDPH5IW10-A				10	200
LDPH10 – Surface Raceway					
LDPH10IW8-A	Tamper resistant two-piece latching surface raceway. Supplied with pre-applied adhesive backed tape. Available in 8' and 10' lengths.	1.52" x .86" (39.0mm x 22.0mm)	Off White	8	160
LDPH10IW10-A				10	200

LDPH raceway requires screw mounting for power cabling applications.

Order number of feet required in multiples of standard length increments.

‡For other colors replace IW (Off White) with EI (Electric Ivory), IG (International Gray), or WH (White).

A.
System
Overview

B1.
Cable Ties

B2.
Cable
Accessories

B3.
Stainless
Steel Ties

C1.
Wiring
Duct

C2.
Surface
Raceway

C3.
Abrasion
Protection

C4.
Cable
Management

D1.
Terminals

D2.
Power
Connectors

D3.
Grounding
Connectors

E1.
Labeling
Systems

E2.
Labels

E3.
Pre-Printed
& Write-On
Markers

E4.
Permanent
Identification

E5.
Lockout/
Tagout/
& Safety
Solutions

F.
Index

A. System Overview



PAN-WAY® LDS Surface Raceway System

B1. Cable Ties

• UL and CSA rated 600 V; meets UL 5A and CSA C22.2 No. 62.1-03 standards; FT4 rated

• Tamper resistant non-hinged design

• Factory applied adhesive backing speeds installation

• Type LDS is **the only non-metallic raceway that is bendable** in low voltage applications to route around and over obstructions

• LDS raceway requires screw mounting using the LMD mounting straps for power cabling installations

• Terminates using surface mount outlet box solutions or *PANDUIT® MINI-COM®* Surface Mount Boxes

B2. Cable Accessories

B3. Stainless Steel Ties

C1. Wiring Duct

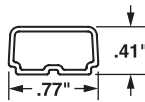

LDS3
Internal Area = .21 Sq. In.

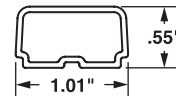

LDS5
Internal Area = .38 Sq. In.

C2. Surface Raceway



LDS3

C3. Abrasion Protection

C4. Cable Management



LDS5

D1. Terminals

D2. Power Connectors



LMD3
LMD5

D3. Grounding Connectors

E1. Labeling Systems

E2. Labels

E3. Pre-Printed & Write-On Markers

E4. Permanent Identification

E5. Lockout/Tagout & Safety Solutions

F. Index

Part Number	Part Description	Raceway Size	Color‡	Length (Ft.)	Std. Ctn. Qty.
-------------	------------------	--------------	--------	--------------	----------------

LDS3 – Surface Raceway

LDS3IW10-A	Tamper resistant one-piece surface raceway. Supplied with pre-applied adhesive backed tape. Available in 10' lengths.	.77" x .41" (20.0mm x 10.4mm)	Off White	10	200
-------------------	---	----------------------------------	-----------	----	-----

LDS5 – Surface Raceway

LDS5IW10-A	Tamper resistant one-piece surface raceway. Supplied with pre-applied adhesive backed tape. Available in 10' lengths.	1.01" x .55" (26.0mm x 14.0mm)	Off White	10	200
-------------------	---	-----------------------------------	-----------	----	-----

Mounting Straps

LMD3IW-Q	For use with LDS3 raceway.	Size 3	Off White	—	100
LMD5IW-Q	For use with LDS5 raceway.	Size 5	Off White	—	100

‡For other colors replace IW (Off White) with EI (Electric Ivory), IG (International Gray), or WH (White). Order number of feet required in multiples of standard length increments.

Method for Bending Type LDS Raceway (Low Voltage Applications)



1) Slide 18" to 30" section of LDS Raceway into PVC pipe heating blanket.
*(Recommended blanket designed for bending 1/2" to 1 1/2" PVC conduit.)



2) Allow section to heat approximately 2 – 3 minutes. Raceway will be soft and pliable, but should not stretch. (Time will vary with blanket temperature and raceway size.)



3) Remove raceway section from blanket and hold in desired position until the raceway cools. Install mounting straps immediately.

*Heating blanket not offered by *PANDUIT*.

Standard Fittings for Low Voltage Applications

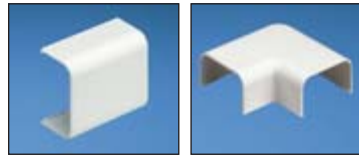

CF

RAF

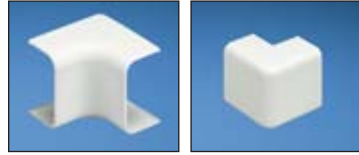

ICF

OCF

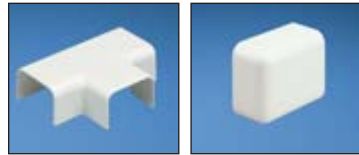

TF

ECF



CRFC

DCF

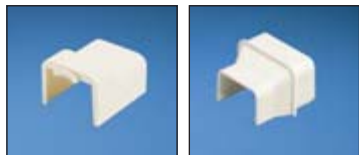

FBA

RF

Part Number	Part Description	Color‡	Std. Pkg. Qty.
CF3IW-E	Coupler fitting for use with LD3 raceway.	Off White	20
CF5IW-E	Coupler fitting for use with LD5 raceway.	Off White	20
CF10IW-X	Coupler fitting for use with LD10 raceway.	Off White	10
RAF3IW-E	Right angle fitting for use with LD3 raceway.	Off White	20
RAF5IW-E	Right angle fitting for use with LD5 raceway.	Off White	20
RAF10IW-X	Right angle fitting for use with LD10 raceway.	Off White	10
ICF3IW-E	Inside corner fitting for use with LD3 raceway.	Off White	20
ICF5IW-E	Inside corner fitting for use with LD5 raceway.	Off White	20
ICF10IW-X	Inside corner fitting for use with LD10 raceway.	Off White	10
OCF3IW-E	Outside corner fitting for use with LD3 raceway.	Off White	20
OCF5IW-E	Outside corner fitting for use with LD5 raceway.	Off White	20
OCF10IW-X	Outside corner fitting for use with LD10 raceway.	Off White	10
TF3IW-E	Tee fitting for use with LD3 raceway.	Off White	20
TF5IW-E	Tee fitting for use with LD5 raceway.	Off White	20
TF10IW-X	Tee fitting for use with LD10 raceway.	Off White	10
ECF3IW-E	End cap fitting for use with LD3 raceway.	Off White	—
ECF5IW-E	End cap fitting for use with LD5 raceway.	Off White	—
ECF10IW-X	End cap fitting for use with LD10 raceway.	Off White	—
CRFC5IW-X	4-way cross fitting for use with LD5, LDPH5, and LDS5 raceway.	Off White	10
DCF3IW-X	Drop ceiling/entrance end fitting for use with LD3 raceway.	Off White	10
DCF5IW-X	Drop ceiling/entrance end fitting for use with LD5 raceway.	Off White	10
DCF10IW-X	Drop ceiling/entrance end fitting for use with LD10 raceway.	Off White	10
FBA5IW-X	Fire box adapter for use with LD5/LDPH5 profile raceway. Note: For low voltage applications only.	Off White	10
FBA10IW-X	Fire box adapter for use with LD10/LDPH10 profile raceway. Note: For low voltage applications only.	Off White	10
RF5X3IW-E	Reducer fitting for LD raceway from size 5 to size 3. For use with LD5 and LD3 raceway. For in-line terminations, use with CF5**.	Off White	20
RF10X3IW-X	Reducer fitting for LD raceway from size 10 to size 3. For use with LD3 and LD10 raceway. For in-line terminations, use with CF10**.	Off White	10
RF10X5IW-X	Reducer fitting for LD raceway from size 10 to size 5. For use with LD5 and LD10 raceway. For in-line terminations, use with CF10**.	Off White	10

‡For other colors replace IW (Off White) with EI (Electric Ivory), IG (International Gray), or WH (White).

A. System Overview



One Inch Bend Radius Fittings for TIA/EIA Compliance

B1. Cable Ties

- 1 inch bend radius fittings are designed to maintain the TIA/EIA-568-B and 569-B required minimum bend radius for high performance copper and fiber optic cabling systems

B2. Cable Accessories



CFX

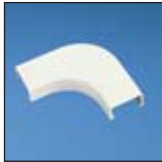

RAFC

B3. Stainless Steel Ties



ICFC



OCFX

C1. Wiring Duct

C2. Surface Raceway



TFC



CRFC5

C3. Abrasion Protection

C4. Cable Management



ECFX



DCEFX

D1. Terminals

D2. Power Connectors



RAEFX



RFX

D3. Grounding Connectors

E1. Labeling Systems

E2. Labels

E3. Pre-Printed & Write-On Markers

E4. Permanent Identification

E5. Lockout/Tagout & Safety Solutions

F. Index

Part Number	Part Description	Color‡	Std. Pkg. Qty.
CFX3IW-X	Coupler fitting for use with LD3, LDPH3, and LDS3 raceway.	Off White	10
CFX5IW-X	Coupler fitting for use with LD5, LDPH5, and LDS5 raceway.	Off White	10
CFX10IW-X	Coupler fitting for use with LD10, LDPH10, and LD2P10 raceway.	Off White	10
RAFC3IW-X	Right angle fitting for use with LD3, LDPH3, and LDS3 raceway.	Off White	10
RAFC5IW-X	Right angle fitting for use with LD5, LDPH5, and LDS5 raceway.	Off White	10
RAFC10IW-X	Right angle fitting for use with LD10 and LDPH10 raceway.	Off White	10
ICFC3IW-X	Inside corner fitting for use with LD3, LDPH3, and LDS3 raceway.	Off White	10
ICFC5IW-X	Inside corner fitting for use with LD5, LDPH5, and LDS5 raceway.	Off White	10
ICFC10IW-X	Inside corner fitting for use with LD10 and LDPH10 raceway.	Off White	10
OCFX3IW-X	Outside corner fitting for use with LDPH3 and LDS3 raceway.	Off White	10
OCFX5IW-X	Outside corner fitting for use with LDPH5 and LDS5 raceway.	Off White	10
OCFX10IW-X	Outside corner fitting for use with LDPH10 and LD2P10 raceway.	Off White	10
TFC3IW-X	Tee fitting for use with LD3, LDPH3, and LDS3 raceway.	Off White	10
TFC5IW-X	Tee fitting for use with LD5, LDPH5, and LDS5 raceway.	Off White	10
TFC10IW-X	Tee fitting for use with LD10 and LDPH10 raceway.	Off White	10
CRFC5IW-X	4-way cross fitting for use with LD5, LDPH5, and LDS5 raceway.	Off White	10
ECFX3IW-X	End cap fitting for use with LDPH3 and LDS3 raceway.	Off White	10
ECFX5IW-X	End cap fitting for use with LDPH5 and LDS5 raceway.	Off White	10
ECFX10IW-X	End cap fitting for use with LDPH10 and LD2P10 raceway.	Off White	10
DCEFXIW-X	Drop ceiling/entrance end fitting for use with LD3, LDPH3, LDS3, LD5, LDPH5, LDS5, LD10 and LDPH10 raceway. Use CA3 or CA5 adapters for LD3 or LD5 profile raceway.	Off White	10
RAEFXIW-X	Right angle/entrance end fitting for use with LD3, LDPH3, LDS3, LD5, LDPH5, LDS5, LD10 and LDPH10 raceway. CA3 or CA5 adapters for LD3 or LD5 profile raceway.	Off White	10
RFX53IW-X	Reducer fitting for use with LD3, LDPH3, LDS3, LD5, LDPH5 and LDS5 raceway. For in-line terminations, use with CFX5**.	Off White	10
RFX103IW-X	Reducer fitting for use with LD3, LDPH3, LD10 and LDPH10 raceway. For in-line terminations, use with CFX10**.	Off White	10
RFX105IW-X	Reducer fitting for use with LD5, LDPH5, LDS5, LD10 and LDPH10 raceway. For in-line terminations, use with CFX10**.	Off White	10

‡For other colors replace IW (Off White) with EI (Electric Ivory), IG (International Gray), or WH (White).



Power Rated Fittings for Power to 600 V – LDPH/LDS/LD2P Raceway Only



CFX



RAFX



ICFX



OCFC



TFX



CRFX



CEFX



ECFX



DCEFX



RAEFX



RFX

Part Number	Part Description	Color‡	Std. Pkg. Qty.
CFX3IW-X	Coupler fitting for use with LD3, LDPH3, and LDS3 raceway.	Off White	10
CFX5IW-X	Coupler fitting for use with LD5, LDPH5, and LDS5 raceway.	Off White	10
CFX10IW-X	Coupler fitting for use with LD10, LDPH10, and LD2P10 raceway.	Off White	10
RAFX3IW-X	Right angle fitting for use with LDPH3 and LDS3 raceway.	Off White	10
RAFX5IW-X	Right angle fitting for use with LDPH5 and LDS5 raceway.	Off White	10
RAFX10IW-X	Right angle fitting for use with LDPH10 and LD2P10 raceway.	Off White	10
ICFX3IW-X	Inside corner fitting for use with LDPH3 and LDS3 raceway.	Off White	10
ICFX5IW-X	Inside corner fitting for use with LDPH5 and LDS5 raceway.	Off White	10
ICFX10IW-X	Inside corner fitting for use with LDPH10 and LD2P10 raceway.	Off White	10
OCFC3IW-X	Outside corner fitting for use with LDPH3 and LDS3 raceway.	Off White	10
OCFC5IW-X	Outside corner fitting for use with LDPH5 and LDS5 raceway.	Off White	10
OCFC10IW-X	Outside corner fitting for use with LDPH10 raceway only.	Off White	10
TFX3IW-X	Tee fitting for use with LDPH3 and LDS3 raceway.	Off White	10
TFX5IW-X	Tee fitting for use with LDPH5 and LDS5 raceway.	Off White	10
TFX10IW-X	Tee fitting for use with LDPH10 raceway only.	Off White	10
CRFX5IW-X	4-way cross fitting for use with LD5, LDPH5, and LDS5 raceway.	Off White	10
CEFXIW-X	Conduit entrance end fitting. This power rated two-piece fitting is designed to accommodate the entrance of 1/2" conduit or align with knockouts on surface mount electrical boxes. For use with LD3/LDPH3 and has breakouts available to work with LD5/LDPH5 and LD10/LDPH10. Cover and base snap together – no hardware is required.	Off White	10
ECFX3IW-X	End cap fitting for use with LDPH3 and LDS3 raceway.	Off White	10
ECFX5IW-X	End cap fitting for use with LDPH5 and LDS5 raceway.	Off White	10
ECFX10IW-X	End cap fitting for use with LDPH10 and LD2P10 raceway.	Off White	10
DCEFXIW-X	Drop ceiling/entrance end fitting for use with LD3, LDPH3, LDS3, LD5, LDPH5, LDS5, LD10 and LDPH10 raceway. Use CA3 or CA5 adapters for LD3 or LD5 profile raceway.	Off White	10
RAEFXIW-X	Right angle/entrance end fitting for use with LD3, LDPH3, LDS3, LD5, LDPH5, LDS5, LD10 and LDPH10 raceway. CA3 or CA5 adapters for LD3 or LD5 profile raceway.	Off White	10
RFX53IW-X	Reducer fitting for use with LD3, LDPH3, LDS3, LD5, LDPH5 and LDS5 raceway. For in-line terminations, use with CFX5**.	Off White	10
RFX103IW-X	Reducer fitting for use with LD3, LDPH3, LD10 and LDPH10 raceway. For in-line terminations, use with CFX10**.	Off White	10
RFX105IW-X	Reducer fitting for use with LD5, LDPH5, LDS5, LD10 and LDPH10 raceway. For in-line terminations, use with CFX10**.	Off White	10

‡For other colors replace IW (Off White) with EI (Electric Ivory), IG (International Gray), or WH (White).

A. System Overview

B1. Cable Ties

B2. Cable Accessories

B3. Stainless Steel Ties

C1. Wiring Duct

C2. Surface Raceway

C3. Abrasion Protection

C4. Cable Management

D1. Terminals

D2. Power Connectors

D3. Grounding Connectors

E1. Labeling Systems

E2. Labels

E3. Pre-Printed & Write-On Markers

E4. Permanent Identification

E5. Lockout/Tagout & Safety Solutions

F. Index

A. System Overview

Raceway Adapters for LD Raceway

- Fit into universal breakout of DCEFX or RAEFX fittings
- For use with types LD3, LDPH3, LDS3, LD5, LDPH5 and LDS5 raceway

B1. Cable Ties

B2. Cable Accessories



CA3
CA5

B3. Stainless Steel Ties

C1. Wiring Duct

C2. Surface Raceway

C3. Abrasion Protection

C4. Cable Management

Part Number	Part Description	Color‡	Std. Pkg. Qty.	Std. Ctn. Qty.
CA3IW-X	Adapter fits into universal breakout of DCEFX or RAEFX fittings. For use LD3, LDPH3, and LDS3 raceway.	Off White	10	50
CA5IW-X	Adapter fits into universal breakout of DCEFX or RAEFX fittings. For use LD5, LDPH5, and LDS5 raceway.	Off White	10	50

‡For other colors replace IW (Off White) with EI (Electric Ivory), IG (International Gray), or WH (White).

D1. Terminals

D2. Power Connectors

D3. Grounding Connectors

Cable Fill Capacities for LD Profile Raceway

This information is to be used as a guide in selecting the proper size raceway. The maximum amounts may vary according to the cable installation methods, straightness of cables, etc.



LD3	LD5	LD10
.21 in. ²	.38 in. ²	1.00 in. ²



LDPH3	LDPH5	LDPH10
.17 in. ²	.33 in. ²	.98 in. ²

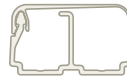

LD2P10 – Left	LDP210 – Right
.43 in. ²	.50 in. ²



LDS3	LDS5
.21 in. ²	.38 in. ²

E1. Labeling Systems

E2. Labels

E3. Pre-Printed & Write-On Markers

E4. Permanent Identification

E5. Lockout/Tagout & Safety Solutions

F. Index

SPEC = 40% cable fill – The recommended design in cable capacity, leaves room for future moves, adds, and changes.

MAX for Data = 60% cable fill – The maximum cable quantity based on cable interweaving and packing factors.

MAX for Power cable fill – The maximum of electrical cables based on UL temperature rise test.

Raceway Type and Configuration	Fill Area (In. ²)	Electrical Cables			Data Grade Cables		Data Grade Cables		Audio/Video		Fiber Optic Cable	
		14 AWG	12 AWG	10 AWG	23/24 AWG/UTP		23 AWG/UTP CM		RG6		2 Strand	
		THHN/T90			Category 6 (4-pr.)		Augmented Category 6					
		0.111	0.130	0.164	Dia. = 0.250		Dia. = 0.354		Dia. = 0.275		Dia. = 0.175	
		FILL			FILL		FILL		FILL		FILL	
		MAX	MAX	MAX	SPEC	MAX	SPEC	MAX	SPEC	MAX	SPEC	MAX
LD3	0.21	—	—	—	1	2	0	1	1	2	3	5
LD5	0.38	—	—	—	3	4	1	2	2	3	6	9
LD10	1.00	—	—	—	8	12	4	7	6	10	16	24
LDPH3	0.17	9	7	4	1	2	0	1	1	1	2	4
LDPH5	0.33	14	12	8	2	4	1	2	2	3	5	8
LDPH10	0.89	18	18	16	7	10	4	6	5	8	14	22
LD2P10 – Left channel	0.43	14	11	8	—	—	—	—	—	—	—	—
LD2P10 – Right channel	0.50	—	—	—	4	6	2	3	3	5	8	12
LDS3	0.21	9	6	4	1	2	0	1	1	2	3	5
LDS5	0.38	10	8	5	3	4	1	2	2	3	6	9

AWG dimensions represent typical outer cable diameter in inches.

Floor Guard

- Accessory to route cables over carpet, concrete, or tile to prevent tripping
- Flexible vinyl material can be easily cut to specific lengths
- Cables route through underside of product

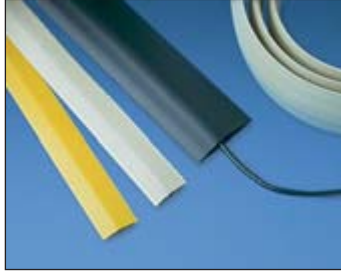

FG1
FG3

Part Number	Part Description	Color‡	Std. Pkg. Qty.
FG1EI6-A	Flexible vinyl material used to route cabling over carpet, tile, and concrete. Product available in 6' and 50' rolls.	Electric Ivory	1
FG1EI50-A	Flexible vinyl material used to route cabling over carpet, tile, and concrete. Product available in 6' and 50' rolls.	Electric Ivory	30
FG3EI50-A	Flexible vinyl material used to route cabling over carpet, tile, and concrete. Product available in 6' and 50' rolls.	Electric Ivory	1
FG3EI6S-A	Flexible vinyl material used to route cabling over carpet, tile, and concrete. Product available in 6' and 50' rolls.	Electric Ivory	30

Mounting tape is pre-applied only to FG3 in 6' lengths.

‡For other colors replace EI (Electric Ivory) with BR (Brown), YL (Safety Yellow) or BL (Black).

PAN-WAY® Surface Raceway Cutting Tool



Part Number	Part Description	Std. Pkg. Qty.	Std. Ctn. Qty.
SRT	Used to cut all LD profile raceway. Leaves a clean burr-free finish on raceway. Can also be used to cut plastic conduit.	1	10

A.
System
Overview

B1.
Cable Ties

B2.
Cable
Accessories

B3.
Stainless
Steel Ties

C1.
Wiring
Duct

C2.
Surface
Raceway

C3.
Abrasion
Protection

C4.
Cable
Management

D1.
Terminals

D2.
Power
Connectors

D3.
Grounding
Connectors

E1.
Labeling
Systems

E2.
Labels

E3.
Pre-Printed
& Write-On
Markers

E4.
Permanent
Identification

E5.
Lockout/
Tagout/
& Safety
Solutions

F.
Index

A.
System
Overview

Foam Tape

B1.
Cable Ties

• Acrylic foam tape – Recommended for high temperature and outdoor applications (180°F) and exposure to UV light

• Rubber foam tape – Excellent quick tack designed for long term shear loads in indoor applications up to 120°F

B2.
Cable
Accessories



P32W2A2
P32W2R1

B3.
Stainless
Steel Ties

C1.
Wiring
Duct

C2.
Surface
Raceway

C3.
Abrasion
Protection

C4.
Cable
Management

D1.
Terminals

D2.
Power
Connectors

D3.
Grounding
Connectors

E1.
Labeling
Systems

E2.
Labels

E3.
Pre-Printed
& Write-On
Markers

E4.
Permanent
Identification

E5.
Lockout/
Tagout/
& Safety
Solutions

F.
Index

Part Number	Part Description	Color	Std. Pkg. Qty.	Std. Ctn. Qty.
1/32" Thick White Acrylic Adhesive				
P32W2A2-50-7	Foam tape, 1/32" (thick) x .50" (wide) x 7 yards, acrylic adhesive.	White	1	100
P32W2A2-75-7	Foam tape, 1/32" (thick) x .75" (wide) x 7 yards, acrylic adhesive.	White	1	60
P32W2A2-100-7	Foam tape, 1/32" (thick) x 1" (wide) x 7 yards, acrylic adhesive.	White	1	50
P32W2A2-50-72	Foam tape, 1/32" (thick) x .50" (wide) x 72 yards, acrylic adhesive.	White	1	9
P32W2A2-75-72	Foam tape, 1/32" (thick) x .75" (wide) x 72 yards, acrylic adhesive.	White	1	7
P32W2A2-100-72	Foam tape, 1/32" (thick) x 1" (wide) x 72 yards, acrylic adhesive.	White	1	5
1/32" Thick White Rubber Adhesive				
P32W2R1-50-7	Foam tape, 1/32" (thick) x .50" (wide) x 7 yards, rubber adhesive.	White	1	100
P32W2R1-75-7	Foam tape, 1/32" (thick) x .75" (wide) x 7 yards, rubber adhesive.	White	1	60
P32W2R1-100-7	Foam tape, 1/32" (thick) x 1" (wide) x 7 yards, rubber adhesive.	White	1	50
P32W2R1-50-72	Foam tape, 1/32" (thick) x .50" (wide) x 72 yards, rubber adhesive.	White	1	9
P32W2R1-75-72	Foam tape, 1/32" (thick) x .75" (wide) x 72 yards, rubber adhesive.	White	1	7
P32W2R1-100-72	Foam tape, 1/32" (thick) x 1" (wide) x 72 yards, rubber adhesive.	White	1	5
P32W2R1-150-72	Foam tape, 1/32" (thick) x 1.5" (wide) x 72 yards, rubber adhesive.	White	1	4

PAN-WAY® COVE RACEWAY

PAN-WAY® Cove Raceway is a full line of NEC and TIA/EIA compliant raceway, which has the appearance of architectural molding; that allows you to route, conceal, protect and terminate copper, voice, video, fiber optic or power cabling. This offering adds elegance to any room or work area by softening the horizontal angles between the wall and ceiling or the vertical angles between two walls.



- UL and CSA rated 600 V
- Bend radius control is maintained throughout the entire system as required by TIA/EIA-568-B and 569-B
- Product mounts high out of reach for increased tamper resistance
- Divided channel system allows for routing and terminations of both power and data cabling
- Raceway and fitting covers may be painted to match any décor



PAN-WAY® Cove Raceway includes a full complement of fittings and transitions easily to other PANDUIT raceway such as LD, LDPH, LD2P10, T-45 and T-70.

A.
System
Overview

B1.
Cable Ties

B2.
Cable
Accessories

B3.
Stainless
Steel Ties

C1.
Wiring
Duct

C2.
Surface
Raceway

C3.
Abrasion
Protection

C4.
Cable
Management

D1.
Terminals

D2.
Power
Connectors

D3.
Grounding
Connectors

E1.
Labeling
Systems

E2.
Labels

E3.
Pre-Printed
& Write-On
Markers

E4.
Permanent
Identification

E5.
Lockout/
Tagout
& Safety
Solutions

F.
Index

Cove Raceway Roadmap

- A. System Overview
- B1. Cable Ties
- B2. Cable Accessories
- B3. Stainless Steel Ties
- C1. Wiring Duct
- C2. Surface Raceway
- C3. Abrasion Protection
- C4. Cable Management
- D1. Terminals
- D2. Power Connectors
- D3. Grounding Connectors
- E1. Labeling Systems
- E2. Labels
- E3. Pre-Printed & Write-On Markers
- E4. Permanent Identification
- E5. Lockout/Tagout & Safety Solutions
- F. Index

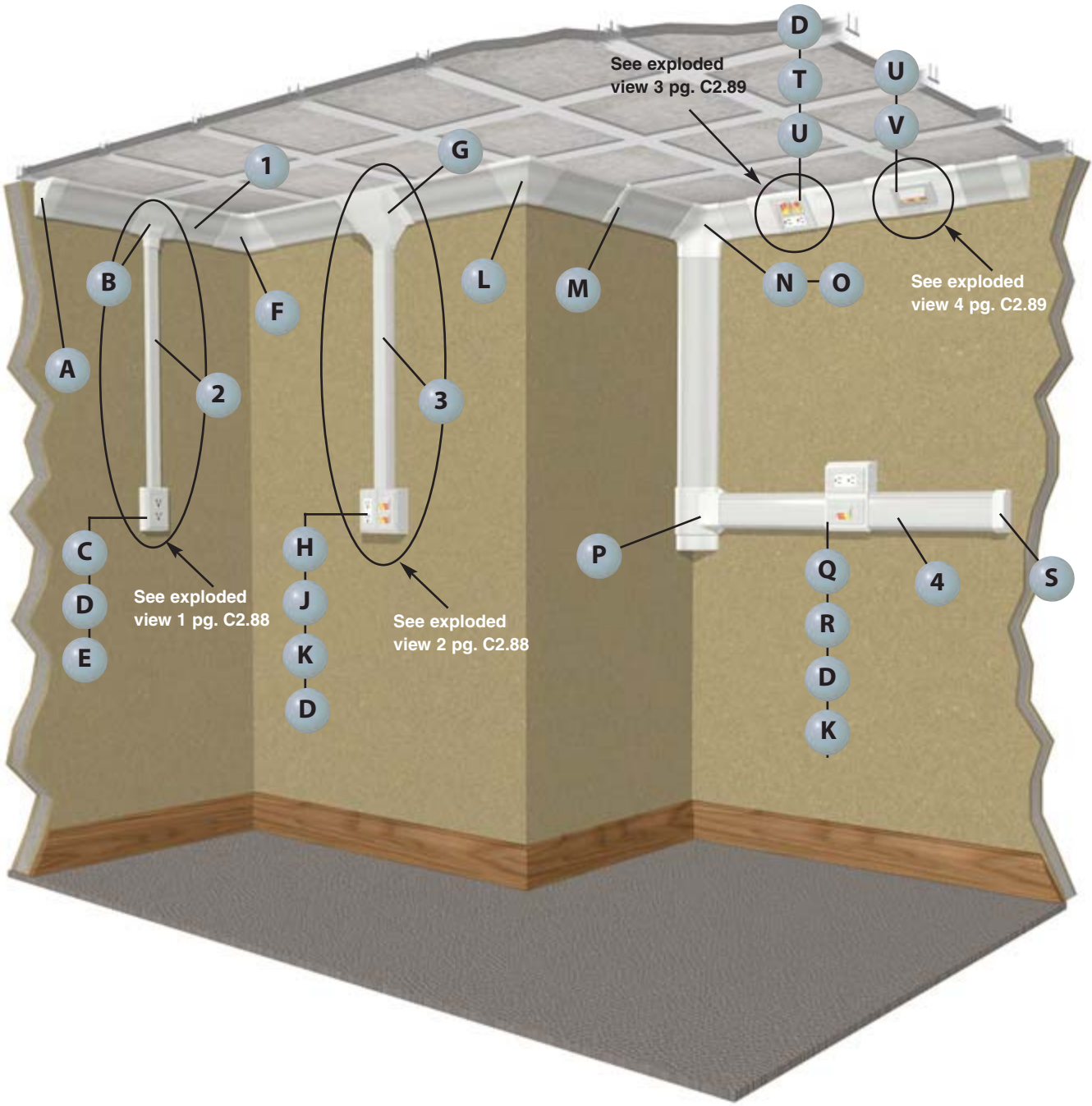

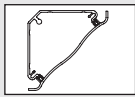

1 WCM35BIW, WCM35CIW – Cove Raceway Base and Cover (page C2.90)

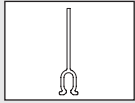

1 WCM35DW – Cove Raceway Divider Wall (page C2.90)

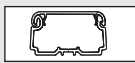

2 LDPH10** – LDPH10 Raceway (page C2.77)

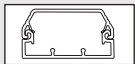

3 T45B**, T45C** – T-45 Raceway Base and Cover (page C2.48)

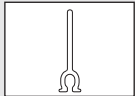

3 T45DW – T-45 Raceway Divider Wall (page C2.48)

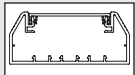

4 T70B**, T70C** – T-70 Raceway Base and Cover (page C2.37)

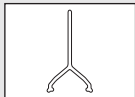

4 T70DW – T-70 Raceway Divider Wall (page C2.37)

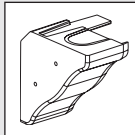

A WCM35ECIW – Cove Raceway End Cap (page C2.91)

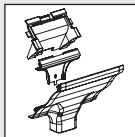

B WCM35TR10IW – Cove Raceway Low Profile Transition Fitting for LD/LDPH10 Raceway (page C2.91)

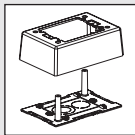

C JBP1** – Power Rated Single Gang Two-Piece Box (page C2.58)

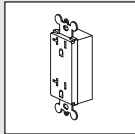

D ERU20** – 20 A Rectangular Outlet (page C2.60)

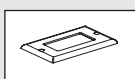

E CPG** – Single Gang Rectangular Electrical/Communication Screw-On Faceplate (page C2.59)

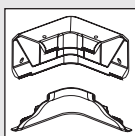

F WCM35ICIW – Cove Raceway Inside Corner Fitting (page C2.91)



G WCM35TRIW – Cove Raceway Transition Fitting for T-45 and LD Series Raceways (page C2.91)

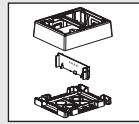

H JBP2FS** – FAST-SNAP™ Double Gang Power Rated Surface Mount Outlet Box (page C2.52)

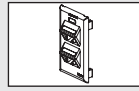

J UIT70FV4** – ULTIMATE ID® Sloped Vertical Snap-On Faceplate

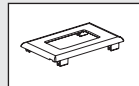

K T70PG** – Single Gang Rectangular Electrical/Communication Snap-On Faceplate (page C2.53)



L WCM35OCIW – Cove Raceway Outside Corner Fitting (page C2.91)



M WCM35CCIW – Cove Raceway Cover Coupler Fitting (page C2.91)

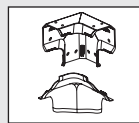

N WCM35TIW – Cove Raceway Tee Fitting (page C2.91)

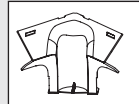

O WCM35TI – Cove Raceway Tee Fitting Insert (page C2.91)

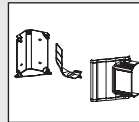

P WCM35TR70IW – Cove Raceway Low Profile Transition Fitting for T-70 Raceway (page C2.91)

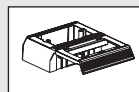

Q T70WC2** – T-70 WORKSTATION OUTLET CENTER™ Offset Box for Snap-On Faceplates (page C2.37)

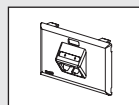

R UIT70FH2** – ULTIMATE ID® Horizontal Snap-On Faceplate



S T70EC** – T70 Raceway End Cap Fitting (page C2.37)

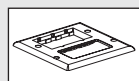

T FP2RC** – Double Gang Rectangular Electrical and Communication Faceplate (page C2.59)

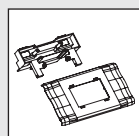

U WCM35DBFIW – Cove Raceway Device Box and Faceplate Adapter (page C2.91)

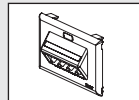

V UIT70FH4** – ULTIMATE ID® Horizontal Snap-On Faceplate

A.
System
Overview

Cove Configurations

B1.
Cable Ties

Exploded View 1

	Components Required	See page
A.	WCM35TR10 = Cove raceway low profile transition fitting for LD/LDP10 raceway.	C2.91
B.	JBP1 = Power rated single gang two-piece box.	C2.58
C.	ERU20 = 20 A rectangular electrical outlet (screws included).	C2.60
D.	CPG = Screw-on single gang rectangular faceplate.	C2.59

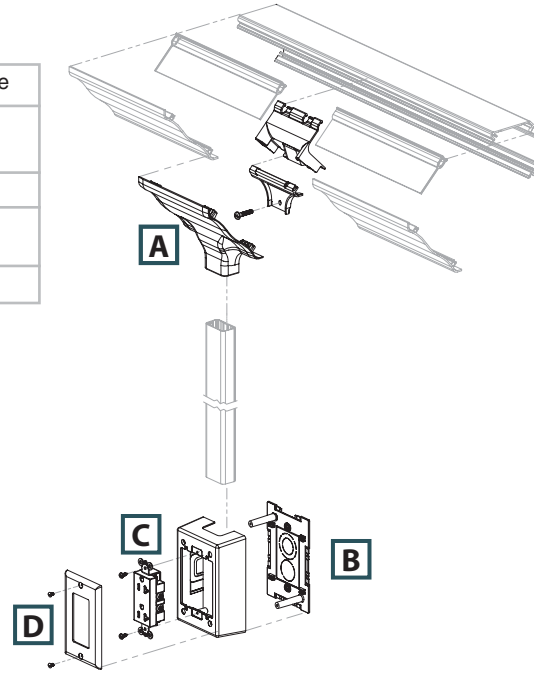

C1.
Wiring
Duct

C2.
Surface
Raceway

C3.
Abrasion
Protection

C4.
Cable
Management

Exploded View 2

	Components Required	See page
A.	WCM35TR = Cove raceway transition fitting.	C2.91
B.	JBP2FS = <i>FAST-SNAP™</i> Double Gang Power Rated Surface Mount Outlet Box.	C2.52
C.	<i>MINI-COM®</i> Modules.	—
D.	T70PG = Single gang rectangular electrical/communication snap-on faceplate.	C2.53
E.	UIT70FV4 = <i>ULTIMATE ID®</i> Sloped Vertical Snap-On Faceplate.	—
F.	ERU20 = 20 A rectangular electrical outlet (screws included).	C2.60

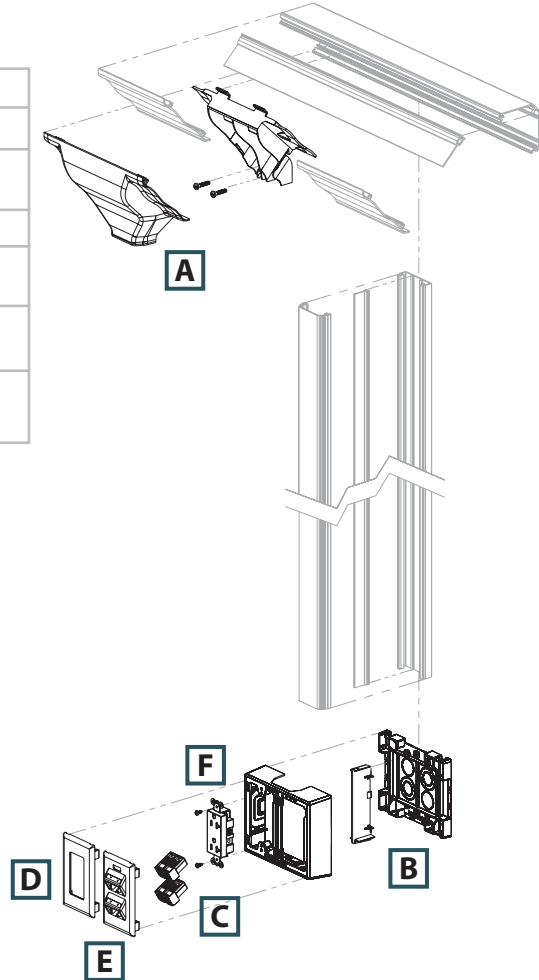

D1.
Terminals

D2.
Power
Connectors

D3.
Grounding
Connectors

E1.
Labeling
Systems

E2.
Labels

E3.
Pre-Printed
& Write-On
Markers

E4.
Permanent
Identification

E5.
Lockout/
Tagout/
& Safety
Solutions

F.
Index

Cove Configurations (continued)

Exploded View 3

	Components Required	See page
A.	WCM35DBF = Cove raceway device box and faceplate adapter.	C2.91
B.	FP2RC = <i>PAN-WAY</i> ® Classic Series Faceplates for power and communication.	C2.59
C.	<i>MINI-COM</i> ® Modules.	—
D.	ERU20 = 20 A rectangular electrical outlet (screws included).	C2.6

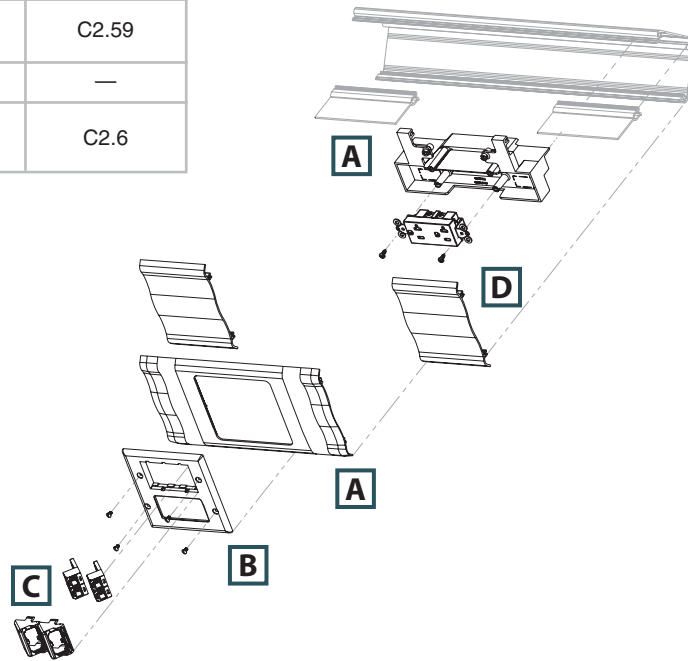

Exploded View 4

	Components Required	See page
A.	WCM35DBF = Cove raceway device box and faceplate adapter.	C2.91
B.	<i>MINI-COM</i> ® Modules.	—
C.	UIT70FH4 = <i>ULTIMATE ID</i> ® Horizontal Snap-On Faceplate.	—

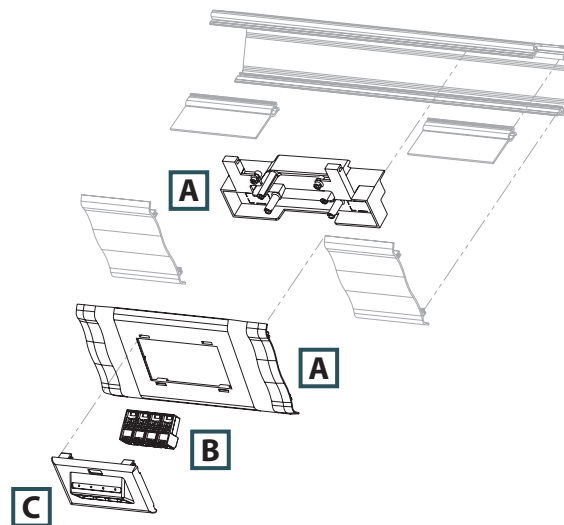

A.
System
Overview

B1.
Cable Ties

B2.
Cable
Accessories

B3.
Stainless
Steel Ties

C1.
Wiring
Duct

C2.
Surface
Raceway

C3.
Abrasion
Protection

C4.
Cable
Management

D1.
Terminals

D2.
Power
Connectors

D3.
Grounding
Connectors

E1.
Labeling
Systems

E2.
Labels

E3.
Pre-Printed
& Write-On
Markers

E4.
Permanent
Identification

E5.
Lockout/
Tagout/
& Safety
Solutions

F.
Index

A. System Overview



PAN-WAY® Cove Raceway System

B1. Cable Ties

- UL and CSA rated 600 V; meets UL 5A and CSA C22.2 No. 62.1-03 standards; FT4 rated
- Bend radius control is maintained throughout the entire cove raceway system as required by TIA/EIA-568-B and 569-B

- Tamper resistant
- Transitions to *PANDUIT* T-70, T-45, and LD profile raceway
- Cove raceway and fittings may be painted to blend with any decor
- Supplied with pre-punched mounting holes

B2. Cable Accessories

B3. Stainless Steel Ties

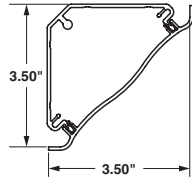

COVE RACEWAY
Internal Area = 5.40 Sq. In.
(3484 Sq. mm)

C1. Wiring Duct

C2. Surface Raceway



WCM35B

C3. Abrasion Protection

C4. Cable Management



WCM35C

D1. Terminals

D2. Power Connectors

D3. Grounding Connectors

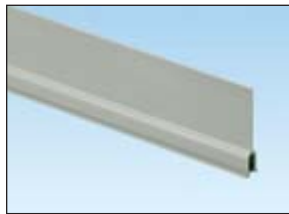

WCM35DW

E1. Labeling Systems

E2. Labels

E3. Pre-Printed & Write-On Markers

E4. Permanent Identification

E5. Lockout/Tagout & Safety Solutions

F. Index

Part Number	Part Description	Raceway Size	Color†	Length (Ft.)	Std. Ctn. Qty.
Cove Raceway Base					
WCM35BIW8	Cove raceway base is available in 8' lengths and is used for mounting in the horizontal corner between the ceiling and wall or vertical corner between walls.	3.50" x 3.50" (89.0mm x 89.0mm)	Off White	8	64
Cove Raceway Cover					
WCM35CIW8	Cove raceway cover available in 8' lengths.	—	Off White	8	64
Cove Raceway Divider Wall					
WCM35DW8	Cove raceway divider wall. Snaps onto rails in cove raceway base to create separate channels. Must use wire retainers to ensure channel separation per UL/CSA. Available in 8' lengths.	—	Gray	8	64

†All parts available in IW (Off White) only except for WCM35DW8 which is available in gray only. Order number of feet required in multiples of standard carton quantity. Order raceway base and cover separately.



PAN-WAY® Cove Raceway Fittings

- Cove raceway fittings are designed to maintain the TIA/EIA-568-B and 569-B required minimum bend radius for high performance copper and fiber optic cabling systems

Image	Part Number	Part Description	Color‡	Std. Pkg. Qty.	Std. Ctn. Qty.
	WCM35CC WCM35IC	WCM35CCIW-X Cover coupler fittings. Used to join two pieces of cove raceway cover together.	Off White	10	100
	WCM35OC WCM35T	WCM35ICIW Inside corner fitting. Used to join cove raceway at inside corners. Maintains a minimum 1" bend radius of cabling. WCM35OCIW Outside corner fitting. Used to join cove raceway at outside corners. Maintains a minimum 1" bend radius of cabling.	Off White	1	10
	WCM35TI WCM35EC	WCM35TIW Tee fitting. Used to join sections of cove raceway to form a "tee" junction. Maintains a minimum 1" bend radius of cabling. WCM35TI Tee fitting insert. Mounts inside cove raceway tee fitting to maintain channel separation at tee junctions. Maintains a minimum 1" bend radius of cabling.	Off White Gray	1	10
	WCM35TR WCM35TR5	WCM35ECIW End cap fitting. Used to terminate or enter cove raceway. Includes breakouts for 1/2" and 3/4" conduit. WCM35TRIW Transition fitting. Used to transition from cove raceway to PAN-WAY® T-45 raceway or LD profile raceway.	Off White	1	10
	WCM35TR10 WCM35TR70	WCM35TR5IW Low profile transition fitting. Used to transition from cove raceway to LD/LDPH5. WCM35TR10IW Low profile transition fitting. Used to transition from cove raceway to LD/LDPH10. WCM35TR70IW Low profile transition fitting. Used to transition from cove raceway to T-70.	Off White	1	10
	WCM35DBF WCM35BF	WCM35DBFIW Device box and faceplate adapter. Used in cove raceway to install single or double gang power and/or data devices in-line. Will accept snap-on or screw-on single gang faceplate or screw-on double gang faceplate. Note: Will accept GFCI or TVSS outlets in single gang configuration only. WCM35BFIW Backfeed fitting. Inserts allow cable entry and exit through the back of the raceway and conduit. Breakouts include 1/2", 3/4", and 1".	Off White	1	10
	WCM35WR-X	WCM35WR-X Wire retainer. Holds wires in place. Will not interfere with cover installation.	Gray	10	—

‡All parts available in IW (Off White) only except WCM35WR-X and WCM35TI which are available in gray only.

A. System Overview

B1. Cable Ties

B2. Cable Accessories

B3. Stainless Steel Ties

C1. Wiring Duct

C2. Surface Raceway

C3. Abrasion Protection

C4. Cable Management

D1. Terminals

D2. Power Connectors

D3. Grounding Connectors

E1. Labeling Systems

E2. Labels

E3. Pre-Printed & Write-On Markers

E4. Permanent Identification

E5. Lockout/Tagout & Safety Solutions

F. Index

A. System Overview

Cable Fill Capacities for Cove Raceway

This information is to be used as a guide in selecting the proper size raceway. The maximum amounts may vary according to the cable installation methods, straightness of cables, etc.

B1. Cable Ties

B2. Cable Accessories

B3. Stainless Steel Ties

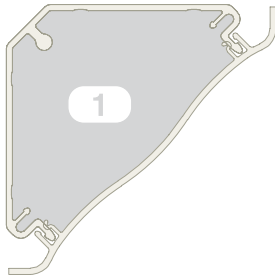

A = 5.4 in.²

Cable fill #1: Open channel without devices.

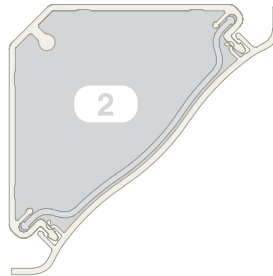

A = 5.0 in.²

Cable fill #2: Open channel with wire retainer.

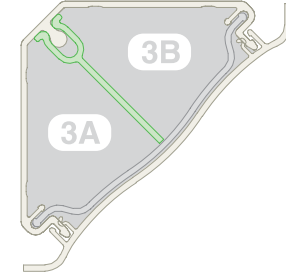

3A = 2.4 in.² 3B = 2.4 in.²

Cable fill #3: Divided channel (power and data) with wire retainer and divider wall.

C2. Surface Raceway

C3. Abrasion Protection

C4. Cable Management

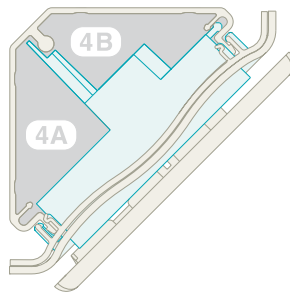

A = 1.6 in.²

A = 1.4 in.²

Cable fill #4: Divided channel (power and data) with device box and faceplate.



A = 1.8 in.²

A = 2.4 in.²

Cable fill #5: Divided channel (power and data) with low profile transition insert.

D1. Terminals

D2. Power Connectors

D3. Grounding Connectors

SPEC = 40% cable fill – The recommended design in cable capacity, leaves room for future moves, adds, and changes.

MAX for Data = 60% cable fill – The maximum cable quantity based on cable interweaving and packing factors.

MAX for Power cable fill – The maximum of electrical cables based on UL temperature rise test.

E1. Labeling Systems

E2. Labels

E3. Pre-Printed & Write-On Markers

E4. Permanent Identification

E5. Lockout/Tagout & Safety Solutions

F. Index

Raceway Type and Configuration	Fill Area (In. ²)	Electrical Cables			Data Grade Cables	Data Grade Cables	Audio/Video		Fiber Optic Cable			
		14 AWG	12 AWG	10 AWG	24 AWG/UTP CM	24 AWG/UTP CM	RG6		2 Strand			
		THHN/T90			Category 6		Category 6A		Dia. = 0.275		Dia. = 0.175	
		0.111	0.130	0.164	Dia. = 0.250		Dia. = 0.330		Dia. = 0.275		Dia. = 0.175	
		FILL			FILL		FILL		FILL		FILL	
MAX	MAX	MAX	SPEC	MAX	SPEC	MAX	SPEC	MAX	SPEC	MAX	MAX	
(UL Temp Rise Test)			(40%)		(60%)		(40%)		(60%)		(40%)	
1. WCM35: No devices.	5.4	50	40	30	44	66	25	37	36	54	89	134
2. WCM35: Using wire retainer – no devices.	5	50	40	30	40	61	23	35	33	50	83	124
3A. WCM35: Power and data using wire retainer and divider wall.	2.4	—	—	—	19	29	11	16	16	24	39	59
3B.	2.4	30	25	20	—	—	—	—	—	—	—	—
4A. WCM35: Power and data using device box and faceplate adapter.	1.6	—	—	—	13	19	7	11	10	16	26	39
4B.	1.4	25	25	20	—	—	—	—	—	—	—	—
5A. WCM35: Power and data using low profile transition insert.	1.8	25	25	20	—	—	—	—	—	—	—	—
5B.	2.4	—	—	—	20	30	11	17	16	25	41	62

AWG dimensions represent typical outer cable diameter in inches.

PAN-WAY® OFFICE FURNITURE RACEWAY

PAN-WAY® Office Furniture Raceway is a one-piece single channel system designed to route data cabling along the top of office furniture partitions. Outlets can be positioned at any point along the partition at desk level or in the corner at the intersection of two partitions. Office furniture raceway has a tamper resistant closure design, which protects sensitive cabling from accidental damage and discourages unauthorized access, yet the system is accessible by a qualified installer for moves, adds, and changes.



- Designed for desktop terminations which utilize the typically unused area of the cubicle
- Fittings meet TIA/EIA bend radius requirements preventing cable performance degradation, yet maintain original aesthetic “squared corner” styling of furniture
- Designed to work with major office furniture manufacturer’s panels (such as STEELCASE*, HERMAN MILLER® and others)
- Robust design includes a one-piece hinge and tamper resistant closure design which increases product stability and reduces inadvertent or unauthorized access to data cabling
- Designed for use with PANDUIT connectivity; also accepts common manufacturers’ connectivity with use of a NEMA standard 70mm faceplate or module frame

The system includes a full complement of fittings, accessories, and termination options. PAN-WAY® Office Furniture Raceway is available in four popular colors to blend with most office furniture systems and creates a virtually invisible cost effective routing solution.

*STEELCASE is a registered trademark of Steelcase Development, Inc.

*HERMAN MILLER is a registered trademark of Herman Miller, Inc., Zeeland MI.

A.
System
Overview

B1.
Cable Ties

B2.
Cable
Accessories

B3.
Stainless
Steel Ties

C1.
Wiring
Duct

C2.
Surface
Raceway

C3.
Abrasion
Protection

C4.
Cable
Management

D1.
Terminals

D2.
Power
Connectors

D3.
Grounding
Connectors

E1.
Labeling
Systems

E2.
Labels

E3.
Pre-Printed
& Write-On
Markers

E4.
Permanent
Identification

E5.
Lockout/
Tagout/
& Safety
Solutions

F.
Index

A.
System
Overview

Office Furniture Raceway Roadmap

B1.
Cable Ties

B2.
Cable
Accessories

B3.
Stainless
Steel Ties

C1.
Wiring
Duct

C2.
Surface
Raceway

C3.
Abrasion
Protection

C4.
Cable
Management

D1.
Terminals

D2.
Power
Connectors

D3.
Grounding
Connectors

E1.
Labeling
Systems

E2.
Labels

E3.
Pre-Printed
& Write-On
Markers

E4.
Permanent
Identification

E5.
Lockout/
Tagout/
& Safety
Solutions

F.
Index



Note: Office furniture raceway is designed to blend with its environment. Shown in white on office slate furniture for illustration purposes only.

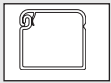

1 OFR20**6 – Office Furniture Raceway
(page C2.98)

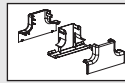

L OFR20MPT** – Mid Panel Tee Fitting
(page C2.100)

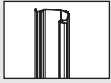

A OFCR70**6 – Corner Raceway Base
(page C2.98)

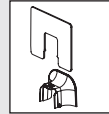

M OFR20WE** – Wall Entrance Fitting
(page C2.100)

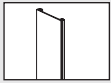

B OFCRC70**6 – Corner Raceway Cover
(page C2.98)

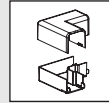

N OFR20RA** – Right Angle Fitting
(page C2.100)

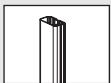

C OFVR5**6 – Vertical Raceway
(page C2.98)

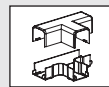

O OFR20T** – Tee Fitting (page C2.100)

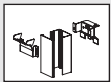

D OFR20CP**8 – Communication Pole
(page C2.99)

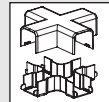

P OFR20CR** – Cross Fitting
(page C2.100)

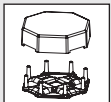

E OFR20OFCR70**4 – Four Cubicle Drop
Fitting (page C2.99)

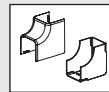

Q OFR20IC** – Inside Corner Fitting
(page C2.101)

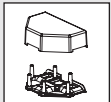

F OFR20OFCR70**2 – Two Cubicle Drop
Fitting (page C2.99)

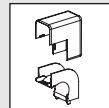

R OFR20OC** – Outside Corner Fitting
(page C2.101)

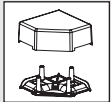

G OFR20OFCR70**1 – One Cubicle Drop
Fitting (page C2.99)



S OFR20CC** – Coupler Fitting
(page C2.101)

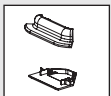

H OFCR70EC** – End Cap Fitting
(page C2.100)

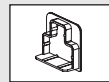

T OFR20EC** – End Cap Fitting
(page C2.101)

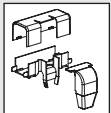

J OFR20SO** – Spill-Over Fitting
(page C2.100)

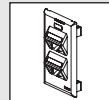

U OF70FV4** – Vertical Sloped
Communication Snap-On Faceplate
(page C2.101)

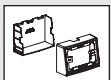

K OFR20DMB** – Desk Mount Box
(page C2.100)

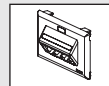

V OF70FH4** – Horizontal Sloped
Communication Snap-On Faceplate
(page C2.101)

A.
System
Overview

Office Furniture Configurations

B1.
Cable Ties

Exploded View 1

B2.
Cable
Accessories

B3.
Stainless
Steel Ties

C1.
Wiring
Duct

C2.
Surface
Raceway

C3.
Abrasion
Protection

C4.
Cable
Management

D1.
Terminals

D2.
Power
Connectors

D3.
Grounding
Connectors

E1.
Labeling
Systems

E2.
Labels

E3.
Pre-Printed
& Write-On
Markers

E4.
Permanent
Identification

E5.
Lockout/
Tagout/
& Safety
Solutions

F.
Index

	Components Required	See page
A.	OFR20OFCR70**4 = Four cubicle drop fitting.	C2.99
B.	OFCR70**6 = Corner raceway base.	C2.98
C.	OFCR70EC = End cap fitting.	C2.100
D.	OF70FV4 = Vertical sloped communication snap-on faceplate.	C2.100
E.	MINI-COM® Modules.	—
F.	OFCRC70**6 = Corner raceway cover.	C2.98

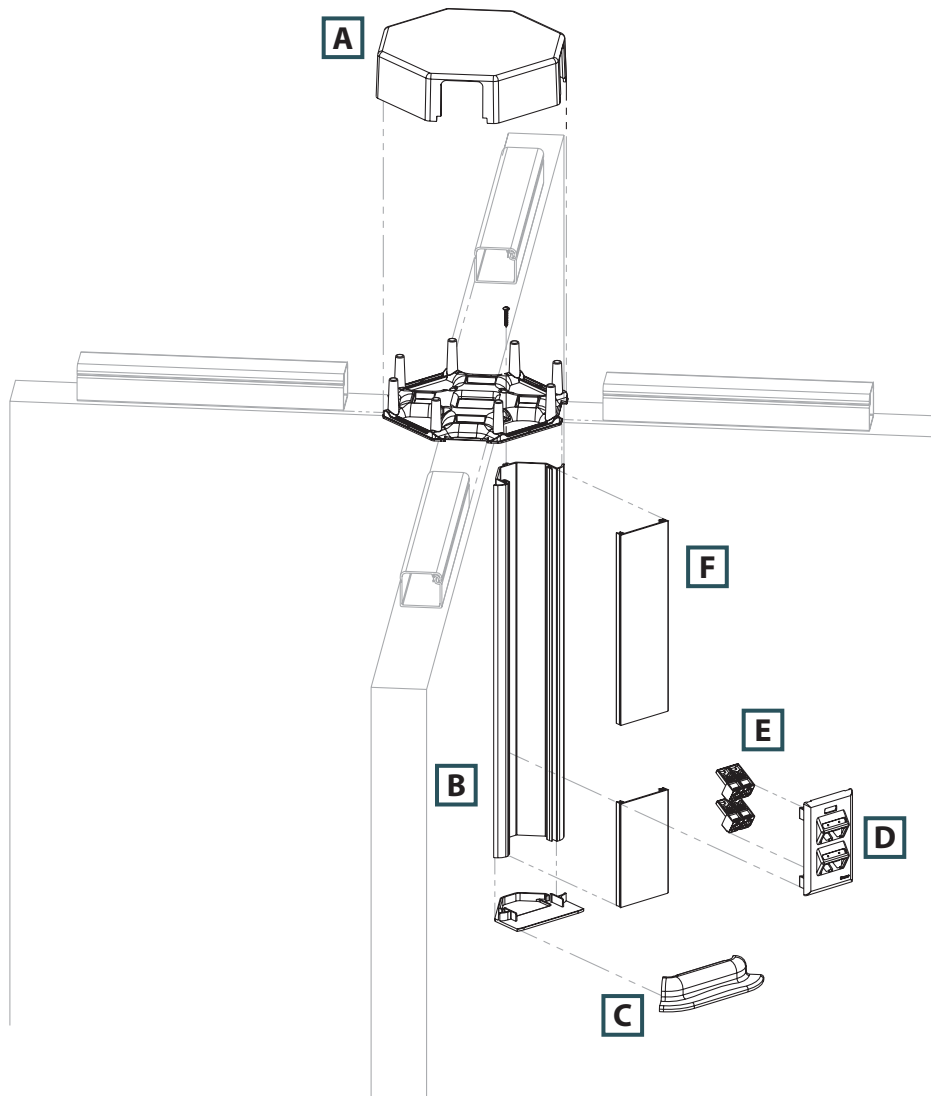

Office Furniture Configurations (continued)

Exploded View 2

	Components Required	See page
A.	OFR20SO** = Spill-over fitting.	C2.100
B.	OFVR5**6 = Vertical raceway.	C2.98
C.	OFR20DMB = Desk mount box.	C2.100
D.	MINI-COM® Modules.	—
E.	OF70FH4** = Horizontal sloped communication snap-on faceplate.	C2.101

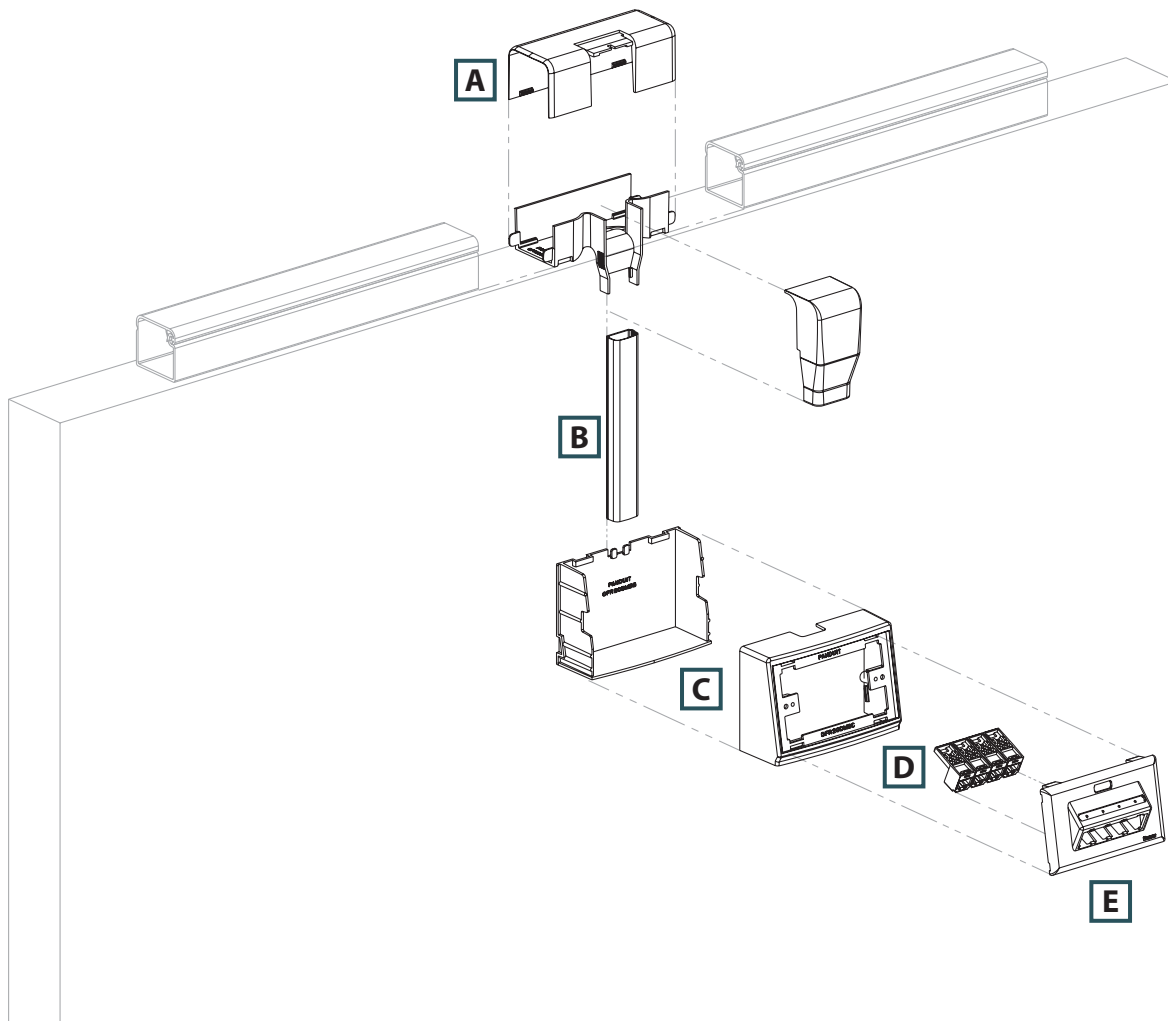

A.
System
Overview

B1.
Cable Ties

B2.
Cable
Accessories

B3.
Stainless
Steel Ties

C1.
Wiring
Duct

C2.
Surface
Raceway

C3.
Abrasion
Protection

C4.
Cable
Management

D1.
Terminals

D2.
Power
Connectors

D3.
Grounding
Connectors

E1.
Labeling
Systems

E2.
Labels

E3.
Pre-Printed
& Write-On
Markers

E4.
Permanent
Identification

E5.
Lockout/
Tagout/
& Safety
Solutions

F.
Index

A. System Overview

PAN-WAY® Office Furniture Raceway System

B1. Cable Ties

B2. Cable Accessories

B3. Stainless Steel Ties

C1. Wiring Duct

C2. Surface Raceway

C3. Abrasion Protection

C4. Cable Management

D1. Terminals

D2. Power Connectors

D3. Grounding Connectors

E1. Labeling Systems

E2. Labels

E3. Pre-Printed & Write-On Markers

E4. Permanent Identification

E5. Lockout/Tagout & Safety Solutions

F. Index

- UL listed in accordance with UL 5C requirements for Class 2 Communication Cable Management Systems
- Maintains bend radius control throughout the entire office furniture raceway system as required by TIA/EIA-568-B and 569-B
- Faceplates are compliant with the labeling requirements of the TIA/EIA-606-A standard
- Robust design and tamper resistant closure increases product stability and prevents damage to cabling during and after installation
- Product supplied with adhesive backing for fast and easy installation
- Creates a virtually invisible solution for routing data cables on panels from all common manufacturers with a top cap width between 1.88 and 2.30 inches
- Designed for use with *PAN-NET®* Connectivity, also accepts all common manufacturers' connectivity with use of a NEMA standard 70mm faceplate or module frame

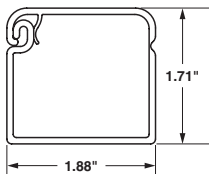

OFFICE FURNITURE RACEWAY
Internal Area = 2.31 Sq. In.



Office Beige (OB)



Office Gray (OG)

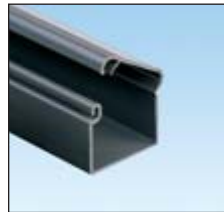

Office Slate (OS)



Medium Tone (MT)



OFR20

Part Number	Part Description	Raceway Size	Color‡	Length (Ft.)	Std. Pkg. Qty.	Std. Ctn. Qty.
OFR20OB6	One-piece single channel low voltage raceway with adhesive tape backing for data cable routing along top of modular furniture partitions. Available in 6' lengths.	1.88" x 1.71" (48.0mm x 44.0mm)	Office Beige	6	6	48
OFR20OB8	One-piece single channel low voltage raceway with adhesive tape backing for data cable routing along top of modular furniture partitions. Available in 8' lengths.	1.88" x 1.71" (48.0mm x 44.0mm)	Office Beige	8	8	64

‡For other colors, replace OB (Office Beige) with OS (Office Slate), OG (Office Gray), or MT (Medium Tone). Order number of feet required in multiples of standard carton quantity.

PAN-WAY® Office Furniture Raceway Fittings

- Office furniture raceway fittings have been designed to maintain the TIA/EIA required 1 inch minimum bend radius for high performance copper and fiber optic cabling systems

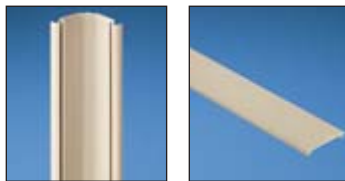

OFCR70

OFCRC70



OFVR5

Part Number	Part Description	Labels Required	Color‡	Std. Pkg. Qty.	Std. Ctn. Qty.
OFCR70OB6	Office furniture corner raceway base. Used to terminate low voltage data cabling in the corner at the intersection of modular office furniture panels. Accepts 70mm standard faceplates. Available in 6' lengths.	—	Office Beige	6	48
OFCRC70OB6	Office furniture corner raceway cover. Available in 6' lengths.	—	Office Beige	6	48
OFVR5OB6	Office furniture vertical raceway. One-piece single channel raceway used to connect OFR20**6 or OFR20**8 to desk mount box (OFR20DMB**) and must be used with OFR20SO** or OFR20DSO**. Available in 6' lengths.	—	Office Beige	6	120

‡For other colors, replace OB (Office Beige) with OS (Office Slate), OG (Office Gray), or MT (Medium Tone). Computer printable labels found on pages E2.4 and E2.5



PAN-WAY® Office Furniture Raceway Fittings (continued)

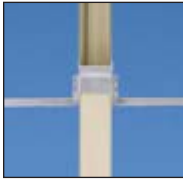

OFR20CP



OFR20FCR70**4



OFR20FCR70**2



OFR20FCR70**1



OFR20FCR70**1P



OFR20FCR70**2P

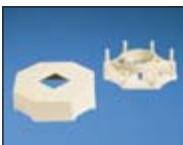

OFR20FCR70**4P

Part Number	Part Description	Labels Required	Color‡	Std. Pkg. Qty.	Std. Ctn. Qty.
OFR20CPOB8	Communication pole. Allows for data cable entry into office furniture raceway from suspended ceiling. 8' pole allows maximum 7' distance from top of furniture partition to ceiling. Must be used with OFR20MPT**. Note: Not intended for use at intersection of furniture panels.	—	Office Beige	1	—
OFR20FCR70OB4	Four cubicle drop fitting. Allows the transition from office furniture raceway run horizontally along partition wall to office furniture corner raceway mounted vertically in four cubicles at the intersection of partitions. Fitting maintains 1" minimum bend radius of cabling. Supplied with adhesive tape.	—	Office Beige	1	10
OFR20FCR70OB2	Two cubicle drop fitting. Allows the transition from office furniture raceway run horizontally along partition wall to office furniture corner raceway mounted vertically in two cubicles at the intersection of partitions. Fitting maintains 1" minimum bend radius of cabling. Supplied with adhesive tape.	—	Office Beige	1	10
OFR20FCR70OB1	One cubicle drop fitting. Allows the transition from office furniture raceway run horizontally along partition wall to office furniture corner raceway mounted vertically in one cubicle at the intersection of partitions. Fitting maintains 1" minimum bend radius of cabling. Supplied with adhesive tape.	—	Office Beige	1	10
OFR20FCR70OB1P	One cubicle drop bypass fitting. Allows the transition from office furniture raceway run horizontally along partition wall, around existing furniture pole, to office furniture corner raceway mounted vertically in one cubicle at the intersection of partitions. Fitting maintains 1" minimum bend radius of cabling. Supplied with adhesive tape.	—	Office Beige	1	10
OFR20FCR70OB2P	Two cubicle drop bypass fitting. Allows the transition from office furniture raceway run horizontally along partition wall, around existing furniture pole, to office furniture corner raceway mounted vertically in two cubicles at the intersection of partitions. Fitting maintains 1" minimum bend radius of cabling. Supplied with adhesive tape.	—	Office Beige	1	10
OFR20FCR70OB4P	Four cubicle drop bypass fitting. Allows the transition from office furniture raceway run horizontally along partition wall, around existing furniture pole, to office furniture corner raceway mounted vertically in four cubicles at the intersection of partitions. Fitting maintains 1" minimum bend radius of cabling. Supplied with adhesive tape.	—	Office Beige	1	10

‡For other colors, replace OB (Office Beige) with OS (Office Slate), OG (Office Gray), or MT (Medium Tone). Computer printable labels found on pages E2.4 and E2.5

Table continues on page C2.100

A. System Overview

B1. Cable Ties

B2. Cable Accessories

B3. Stainless Steel Ties

C1. Wiring Duct

C2. Surface Raceway

C3. Abrasion Protection

C4. Cable Management

D1. Terminals

D2. Power Connectors

D3. Grounding Connectors

E1. Labeling Systems

E2. Labels

E3. Pre-Printed & Write-On Markers

E4. Permanent Identification

E5. Lockout/Tagout & Safety Solutions

F. Index

A. System Overview



PAN-WAY® Office Furniture Raceway Fittings (continued)

B1. Cable Ties



OFRCR70EC

B2. Cable Accessories



OFR20SO

B3. Stainless Steel Ties



OFR20DSO

C1. Wiring Duct

C2. Surface Raceway

C3. Abrasion Protection



OFR20DMB

C4. Cable Management



OFR20MPT

D1. Terminals

D2. Power Connectors

D3. Grounding Connectors



OFR20WE

OFR20RA

E1. Labeling Systems

E2. Labels



OFR20T

OFR20CR

E3. Pre-Printed & Write-On Markers

E4. Permanent Identification

E5. Lockout/Tagout & Safety Solutions

F. Index

Part Number	Part Description	Labels Required	Color‡	Std. Pkg. Qty.	Std. Ctn. Qty.
OFRCR70ECOB	Corner raceway end cap fitting. Opening allows cord passage through fitting such as monitor and keyboard cables. Supplied with adhesive tape.	—	Office Beige	1	10
OFR20SOOB	Spill-over fitting. Allows transition from office furniture raceway run horizontally along partition wall to office furniture vertical raceway in one location. Adjustable fitting maintains 1" minimum bend radius of cabling and works with various panel widths between 1.88"– 2.30" (47.7mm - 58mm). Supplied with adhesive tape.	—	Office Beige	1	10
OFR20DSOOB	Double spill-over fitting. Fitting is used to spill over both sides of the furniture partitions at the same location. Incorporates a built-in, yet removable end cap that eliminates the need for additional raceway and fittings to terminate the pathway.	—	Office Beige	1	10
OFR20DMBOB	Desk mount box. Box accepts office furniture snap-on faceplates as well as 70mm NEMA standard screw-on faceplates. Designed for use with OFVR5**6 raceway and OFR20SO**, OFR20DSO** spill-over fittings. Supplied with adhesive tape.	—	Office Beige	1	10
OFR20MPTOB	Mid-panel tee fitting. Used to connect communication pole to office furniture raceway run horizontally along partition wall. Supplied with adhesive tape. Note: not intended for use at intersection of furniture panels.	—	Office Beige	1	10
OFR20WEOB	Wall entrance fitting. Allows entry from wall to office furniture raceway run horizontally along partition walls. Fitting includes bend radius protection and trim plate to cover wall opening. Requires minimum wall opening of 4.5"W x 3.0"H (114.3mm x 76.2mm). Supplied with adhesive tape.	—	Office Beige	1	10
OFR20RAOB	Right angle fitting. Used to join sections of office furniture raceway at 90° flat junction. Supplied with adhesive tape.	—	Office Beige	1	10
OFR20TOB	Tee fitting. Used to create an undivided tee junction between sections of office furniture raceway. Supplied with adhesive tape.	—	Office Beige	1	10
OFR20CROB	Cross fitting. Used to join sections of office furniture raceway at four corners. Supplied with adhesive tape.	—	Office Beige	1	10

‡For other colors, replace OB (Office Beige) with OS (Office Slate), OG (Office Gray), or MT (Medium Tone). Computer printable labels found on pages E2.4 and E2.5



PAN-WAY® Office Furniture Raceway Fittings (continued)

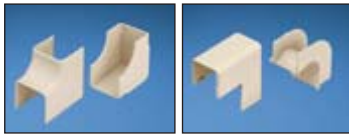

OFR20IC

OFR20OC



OFR20CC



OFR20LC

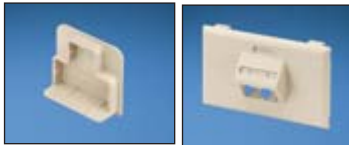

OFR20EC

OF70FH2

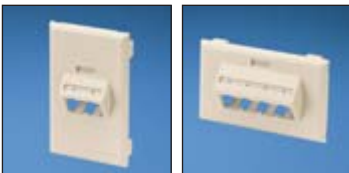

OF70FV2

OF70FH4



OF70FV4

T70SDB-X

Part Number	Part Description	Labels Required	Color‡	Std. Pkg. Qty.	Std. Ctn. Qty.
OFR20ICOB	Inside corner fitting. Used to join sections of office furniture raceway at inside corner. Supplied with adhesive tape.	—	Office Beige	1	10
OFR20OCOB	Outside corner fitting. Used to join sections of office furniture raceway at outside corner. Supplied with adhesive tape.	—	Office Beige	1	10
OFR20CCOB-X	Coupler fitting. For use with office furniture raceway.	—	Office Beige	10	100
OFR20LCOB	Long coupler fitting (with base). Used to bridge office furniture raceway between panel sections. Can also be used to fill void left by spill-over fitting, when furniture partitions are reconfigured. Supplied with adhesive tape.	—	Office Beige	1	10
OFR20ECOB	End cap fitting. Used to terminate office furniture raceway. Supplied with adhesive tape.	—	Office Beige	1	10
OF70FH2OB	Snap-on single gang horizontal sloped communication faceplate. Accepts up to two PANDUIT® MINI-COM® Modules (not included). No additional mounting hardware required. TIA/EIA-606-A compliant.	1-One Port 1-Two Port	Office Beige	1	10
OF70FV2OB	Snap-on single gang vertical sloped communication faceplate. Accepts up to two PANDUIT® MINI-COM® Modules (not included). No additional mounting hardware required. TIA/EIA-606-A compliant.	1-One Port 1-Two Port	Office Beige	1	10
OF70FH4OB	Snap-on single gang horizontal sloped communication faceplate. Accepts up to four PANDUIT® MINI-COM® Modules (not included). No additional mounting hardware required. TIA/EIA-606-A compliant.	1-One Port 1-Four Port	Office Beige	1	10
OF70FV4OB	Snap-on single gang vertical sloped communication faceplate. Accepts up to four PANDUIT® MINI-COM® Modules (not included). No additional mounting hardware required. TIA/EIA-606-A compliant.	1-One Port 2-Two Port	Office Beige	1	10
T70SDB-X	Standard faceplate bracket. Used to mount NEMA standard 70mm single gang screw-on faceplates. Can be used with T-70, Twin-70, TG-70 raceway and PAN-POLE™ Communication Pole.	—	Gray	10	—

‡For other colors, replace OB (Office Beige) with OS (Office Slate), OG (Office Gray), or MT (Medium Tone). Computer printable labels found on pages E2.4 and E2.5

A.
System
Overview

B1.
Cable Ties

B2.
Cable
Accessories

B3.
Stainless
Steel Ties

C1.
Wiring
Duct

C2.
Surface
Raceway

C3.
Abrasion
Protection

C4.
Cable
Management

D1.
Terminals

D2.
Power
Connectors

D3.
Grounding
Connectors

E1.
Labeling
Systems

E2.
Labels

E3.
Pre-Printed
& Write-On
Markers

E4.
Permanent
Identification

E5.
Lockout/
Tagout/
& Safety
Solutions

F.
Index

A.
System
Overview

Cable Fill Capacities for Office Furniture Raceway

B1.
Cable Ties

This information is to be used as a guide in selecting the proper size raceway. The maximum amounts may vary according to the cable installation methods, straightness of cables, etc.

B2.
Cable
Accessories

B3.
Stainless
Steel Ties

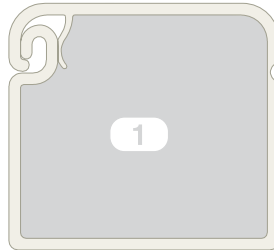

A = 2.31 in.²

Cable fill #1: Open channel without devices

C1.
Wiring
Duct

C2.
Surface
Raceway

C3.
Abrasion
Protection

SPEC = 40% cable fill – The recommended design in cable capacity, leaves room for future moves, adds, and changes.

MAX for Data = 60% cable fill – The maximum cable quantity based on cable interweaving and packing factors.

C4.
Cable
Management

D1.
Terminals

Raceway Type and Configuration	Fill Area (In. ²)	Electrical Cables			Data Grade Cables		Data Grade Cables		Audio/Video		Fiber Optic Cable	
		14 AWG	12 AWG	10 AWG	24 AWG/UTP CM		24 AWG/UTP CM		RG6		2 Strand	
		THHN/T90			Cat. 6		Cat. 6A		DIA. = 0.275		DIA. = 0.175	
		0.111	0.130	0.164	DIA. = 0.250		DIA. = 0.330		DIA. = 0.275		DIA. = 0.175	
		FILL			FILL		FILL		FILL		FILL	
MAX	MAX	MAX	SPEC	MAX	SPEC	MAX	SPEC	MAX	SPEC	MAX	SPEC	MAX
40%	40%	40%	40%	60%	40%	60%	40%	60%	40%	60%	40%	60%
OFR20	2.3	—	—	—	18	28	10	16	15	23	38	57

AWG dimensions represent typical outer cable diameter in inches.

E1.
Labeling
Systems

E2.
Labels

E3.
Pre-Printed
& Write-On
Markers

E4.
Permanent
Identification

E5.
Lockout/
Tagout/
& Safety
Solutions

F.
Index

PAN-POLE™ POWER AND COMMUNICATION POLES

PAN-POLE™ Power and Communication Poles provide industry-leading solutions for cable routing in the open office environment. Available with pre-terminated electrical outlets with divided channel for power and communication applications or as an open channel communication pole.



- Tamper resistant cover
- Bend radius control fitting (above ceiling) as required by TIA/EIA-568-B and 569-B.
- Complete with ceiling and floor mounting hardware

PAN-POLE™ Power and Communication Poles accept NEMA standard 70mm screw-on faceplates or superior PAN-WAY® Snap-On Faceplates.

A.
System
Overview

B1.
Cable Ties

B2.
Cable
Accessories

B3.
Stainless
Steel Ties

C1.
Wiring
Duct

C2.
Surface
Raceway

C3.
Abrasion
Protection

C4.
Cable
Management

D1.
Terminals

D2.
Power
Connectors

D3.
Grounding
Connectors

E1.
Labeling
Systems

E2.
Labels

E3.
Pre-Printed
& Write-On
Markers

E4.
Permanent
Identification

E5.
Lockout/
Tagout/
& Safety
Solutions

F.
Index

A. System Overview



PAN-POLE™ Power Pole

B1. Cable Ties

- Dual channel aluminum pole is equipped with pre-terminated electrical outlets and provides channel separation for the installation of communication cabling and modules

B2. Cable Accessories

- UL and CSA rated 600 V
- Available in 11 or 13 foot lengths and supplied with a non-metallic cover
- Electrical outlets are pre-wired

B3. Stainless Steel Ties

Pre-installed components include:

1. Blank non-metallic cover
2. Two 20 A factory wired rectangular outlets with wiring fed through power channel to base of power entry box

C1. Wiring Duct

C2. Surface Raceway

C3. Abrasion Protection

C4. Cable Management

D1. Terminals

D2. Power Connectors

D3. Grounding Connectors

E1. Labeling Systems

E2. Labels

E3. Pre-Printed & Write-On Markers

E4. Permanent Identification

E5. Lockout/Tagout & Safety Solutions

F. Index

3. Power entry with 1/2" and 3/4" conduit breakouts
4. Removable plate for power wiring connections
5. Ground screw pre-mounted behind removable plate

Supplied mounting hardware includes:

1. Entry end bend radius fitting
2. Ceiling T-bar bracket
3. Ceiling tile trim plate
4. End cap
5. End cap floor grip pad



PCPA11R20
PCPA13R20

Part Number	Part Description	Color‡	Std. Pkg. Qty.
PCPA11R20IW	PAN-POLE™ Power Pole assembly is supplied in 11' length for maximum ceiling height of 10'. Dual channel design allows for the installation of communication outlets.	Off White	1
PCPA13R20IW	PAN-POLE™ Power Pole assembly is supplied in 13' length for maximum ceiling heights of 12'. Dual channel design allows for the installation of communication outlets.	Off White	1

Communication components sold separately.

‡For other colors replace IW (Off White) with EI (Electric Ivory).

Installation of Communication Outlets on *PAN-POLE™* Power Pole

Utilizing Standard Screw-On Faceplates

	Components Required	See page
A.	CPG** = Single gang rectangular screw-on faceplate (screws included).	C2.59
B.	CFG2** = <i>MINI-COM</i> ® Module Frame – 2-port.	—
C.	<i>MINI-COM</i> ® Modules.	—
D.	T70SDB-X = Standard faceplate bracket.	C2.40
E.	PCPA**R20 power pole.	C2.104

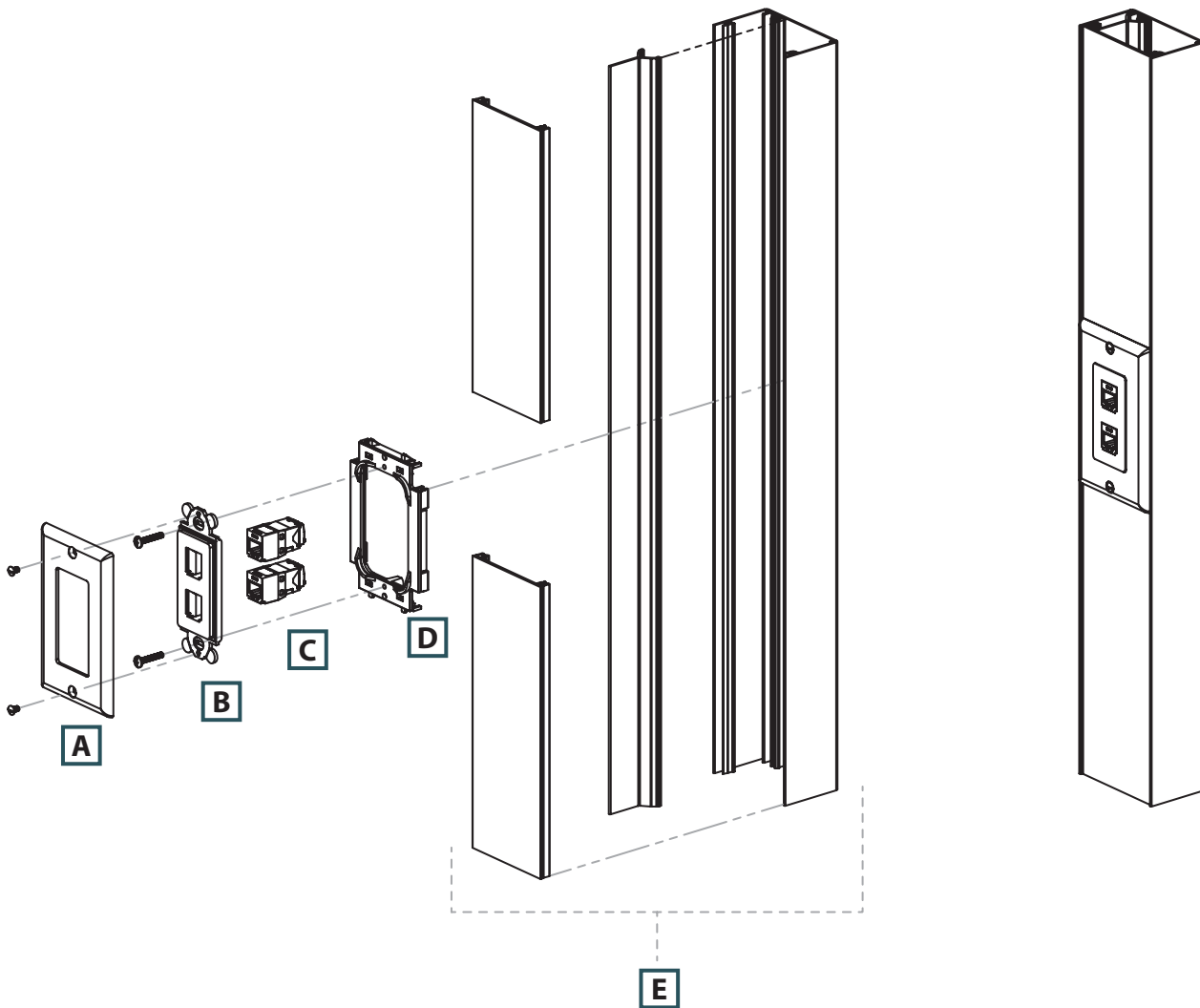

A.
System
Overview

B1.
Cable Ties

B2.
Cable
Accessories

B3.
Stainless
Steel Ties

C1.
Wiring
Duct

C2.
Surface
Raceway

C3.
Abrasion
Protection

C4.
Cable
Management

D1.
Terminals

D2.
Power
Connectors

D3.
Grounding
Connectors

E1.
Labeling
Systems

E2.
Labels

E3.
Pre-Printed
& Write-On
Markers

E4.
Permanent
Identification

E5.
Lockout/
Tagout/
& Safety
Solutions

F.
Index

A.
System
Overview

Installation of Communication Outlets on *PAN-POLE™* Power Pole (continued)

B1.
Cable Ties

Utilizing *PANDUIT* Snap-On Faceplates

B2.
Cable
Accessories

	Components Required	See page
A.	UIT70FV2** = Single gang vertical sloped communication snap-on faceplate.	—
B.	<i>MINI-COM</i> ® Modules.	—
C.	PCPA**R20 power pole.	C2.104

B3.
Stainless
Steel Ties

C1.
Wiring
Duct

C2.
Surface
Raceway

C3.
Abrasion
Protection

C4.
Cable
Management

D1.
Terminals

D2.
Power
Connectors

D3.
Grounding
Connectors

E1.
Labeling
Systems

E2.
Labels

E3.
Pre-Printed
& Write-On
Markers

E4.
Permanent
Identification

E5.
Lockout/
Tagout/
& Safety
Solutions

F.
Index

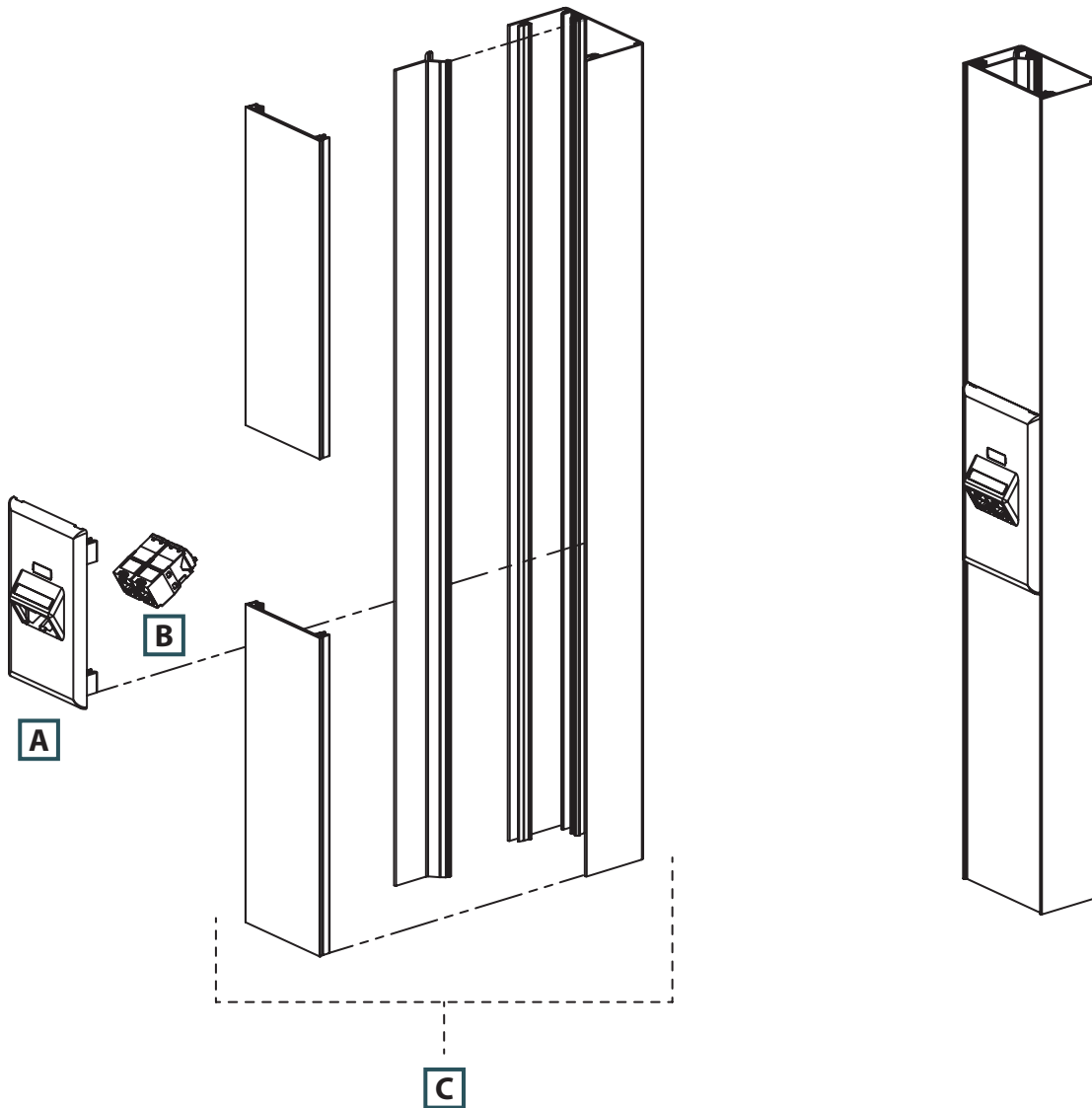

PAN-POLE™ Communication Pole

- Single channel aluminum pole for routing low voltage communication cabling only
- Poles are available in 11 or 13 foot lengths and are supplied with a non-metallic cover

Supplied mounting hardware includes:

1. Entry end bend radius fitting
2. Ceiling T-bar bracket
3. Ceiling tile trim plate
4. End cap
5. End cap floor grip pad



PCPA11
PCPA13

Part Number	Part Description	Color‡	Std. Pkg. Qty.
PCPA11IW	PAN-POLE™ Communication Pole assembly is supplied in 11' length for maximum ceiling height of 10'.	Off White	1
PCPA13IW	PAN-POLE™ Communication Pole assembly is supplied in 13' length for maximum ceiling height of 12'.	Off White	1

Communication components sold separately.

‡For other colors replace IW (Off White) with EI (Electric Ivory).

A.
System
Overview

B1.
Cable Ties

B2.
Cable
Accessories

B3.
Stainless
Steel Ties

C1.
Wiring
Duct

C2.
Surface
Raceway

C3.
Abrasion
Protection

C4.
Cable
Management

D1.
Terminals

D2.
Power
Connectors

D3.
Grounding
Connectors

E1.
Labeling
Systems

E2.
Labels

E3.
Pre-Printed
& Write-On
Markers

E4.
Permanent
Identification

E5.
Lockout/
Tagout/
& Safety
Solutions

F.
Index

A.
System
Overview

B1.
Cable Ties

B2.
Cable
Accessories

B3.
Stainless
Steel Ties

C1.
Wiring
Duct

C2.
Surface
Raceway

C3.
Abrasion
Protection

C4.
Cable
Management

D1.
Terminals

D2.
Power
Connectors

D3.
Grounding
Connectors

E1.
Labeling
Systems

E2.
Labels

E3.
Pre-Printed
& Write-On
Markers

E4.
Permanent
Identification

E5.
Lockout/
Tagout/
& Safety
Solutions

F.
Index

Installation of Communication Outlets on *PAN-POLE™* Communication Pole

Utilizing Standard Screw-On Faceplates

	Components Required	See page
A.	CPG** = Single gang rectangular screw-on faceplate (screws included).	C2.59
B.	CFG2** = <i>MINI-COM</i> ® Module Frame – 2-port.	—
C.	<i>MINI-COM</i> ® Modules.	—
D.	T70SDB-X = Standard faceplate bracket.	C2.40
E.	PCPA** = Communication pole.	C2.107

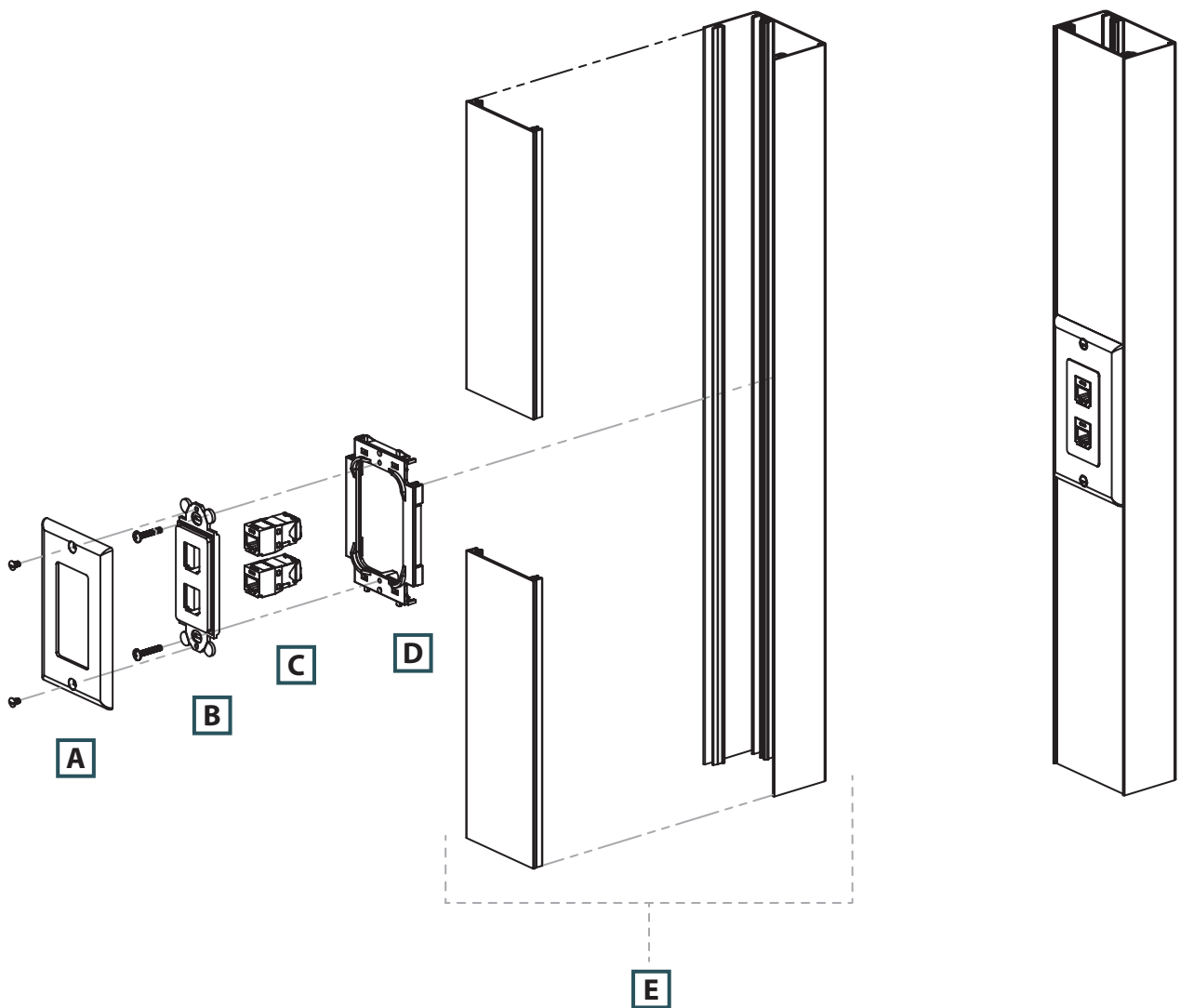

Installation of Communication Outlets on *PAN-POLE™* Communication Pole (continued)

Utilizing *PANDUIT* Snap-On Faceplates

	Components Required	See page
A.	UIT70FV2** = Single gang vertical sloped communication snap-on faceplate.	—
B.	MINI-COM® Modules.	—
C.	PCPA** = Communication pole.	C2.107

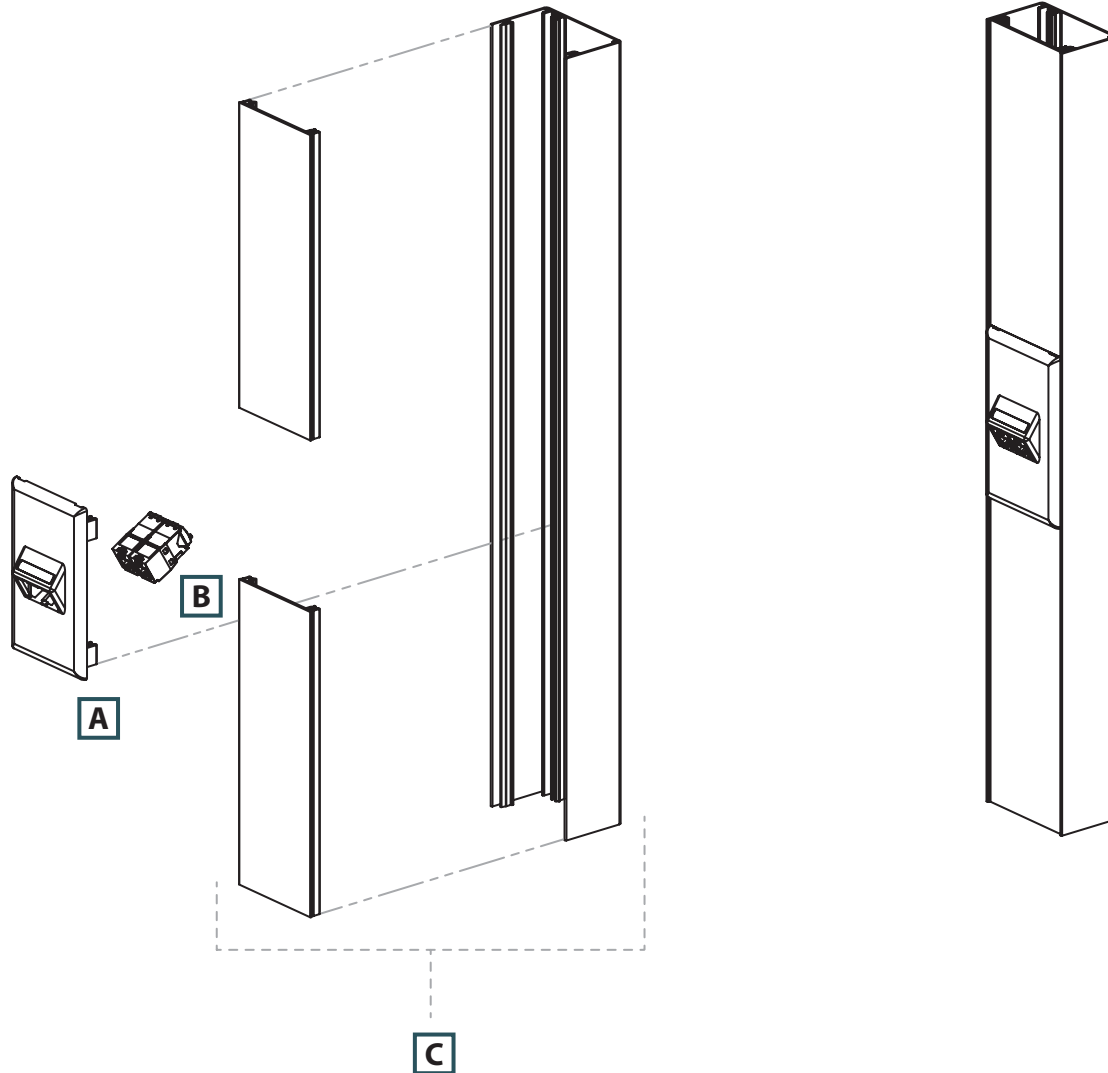

A.
System
Overview

B1.
Cable Ties

B2.
Cable
Accessories

B3.
Stainless
Steel Ties

C1.
Wiring
Duct

C2.
Surface
Raceway

C3.
Abrasion
Protection

C4.
Cable
Management

D1.
Terminals

D2.
Power
Connectors

D3.
Grounding
Connectors

E1.
Labeling
Systems

E2.
Labels

E3.
Pre-Printed
& Write-On
Markers

E4.
Permanent
Identification

E5.
Lockout/
Tagout
& Safety
Solutions

F.
Index

A. System Overview



PAN-POLE™ Extension Kits

B1. Cable Ties

B2. Cable Accessories

B3. Stainless Steel Ties

C1. Wiring Duct

C2. Surface Raceway

C3. Abrasion Protection

C4. Cable Management



PCPAK22
PCPAK16

Part Number	Part Description	Color‡	Std. Pkg. Qty.
PCPAK22IW	<i>PAN-POLE™</i> Extension Kit. To extend the 11' pole to 22'. Extension kit includes: Fully assembled 11' pole with brace/coupler, additional wiring, and screws. Note: Customer needs to purchase a separate standard 11' pole to make the required length.	Off White	1
PCPAK16IW	<i>PAN-POLE™</i> Extension Kit. To extend the 13' pole to 16'. Extension kit includes: fully assembled 3' pole with brace/coupler, additional wiring, and screws. Note: Customer needs to purchase a separate standard 13' pole to make the required length.	Off White	1

‡All product color is (IW) Off White.



PAN-POLE™ Power Addition Kits and Standard Faceplate Bracket

- Power addition kits (UL listed for field installation) provide for the addition of power outlets
- Allow for the installation of up to three additional duplex outlets (five outlets max.)

- Outlets may be added to the existing factory wired circuit or one additional circuit may be added



PCPAKR20



PCPAKR



T70SDB-X

Part Number	Part Description	Color‡	Std. Pkg. Qty.	Std. Ctn. Qty.
PCPAKR20IW	Power addition kit includes 20 A rectangular outlet with two mounting screws, outlet mounting bracket with one mounting screw, and snap-on faceplate.	Off White	1	10
PCPAKRIW	Power addition kit includes outlet mounting bracket with one mounting screw and snap-on faceplate. <i>Rectangular power outlet purchased separately.</i>	Off White	1	10
T70SDB-X	Standard faceplate bracket. Used to mount NEMA standard 70mm single gang screw-on faceplates. Can be used with T-70, Twin-70, TG-70 raceway and <i>PAN-POLE™</i> Communication Pole.	Gray	10	—

‡For other colors replace IW (Off White) with EI (Electric Ivory).

When purchasing power addition kit with 20A outlet, use with *PAN-POLE™* Power Pole, PCPA11R20IW and PCPA13R20IW.

When purchasing power addition it without outlet, rectangular power outlet needs to be purchased separately. Use with *PAN-POLE™* Power Pole, PCPA11R20EI and PCPA13R20EI.



PAN-POLE™ Replacement Parts

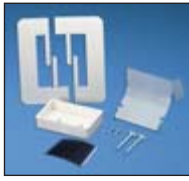

PCPKIT



PCPTP



PCPEC



PCBRC

Part Number	Part Description	Color	Std. Pkg. Qty.	Std. Ctn. Qty.
PCPKITIW	Replacement parts include: bend radius control ramp, two thumb screws, one two-piece ceiling trim plate and one end cap with floor grip pad. Also available in EI (Electric Ivory).	Off White	1	5
PCPTPIW	Replacement ceiling trim plate.	Off White	1	—
PCPECIW	Replacement end cap with floor grip pad. Also available in EI (Electric Ivory).	Off White	1	—
PCBRC	Replacement bend radius control ramp with T-bar bracket for attaching pole to T-bar. Includes mounting screws.	Gray	1	—

A. System Overview

B1. Cable Ties

B2. Cable Accessories

B3. Stainless Steel Ties

C1. Wiring Duct

C2. Surface Raceway

C3. Abrasion Protection

C4. Cable Management

D1. Terminals

D2. Power Connectors

D3. Grounding Connectors

E1. Labeling Systems

E2. Labels

E3. Pre-Printed & Write-On Markers

E4. Permanent Identification

E5. Lockout/Tagout & Safety Solutions

F. Index

Cable Fill Capacities for *PAN-POLE™* Power and Communication Poles

The maximum amounts may vary according to the cable installation methods, straightness of cables, etc.

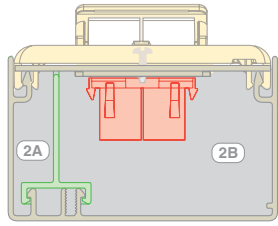

A = .47 in.² A = 2.75 in.²

Cable fill #1: Power pole with data terminals using vertical sloped snap-on communication faceplate.

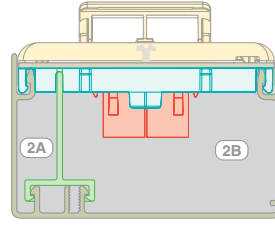

A = .43 in.² A = 2.15 in.²

Cable fill #2: Power pole with data terminals using sloped screw-on communication faceplate.

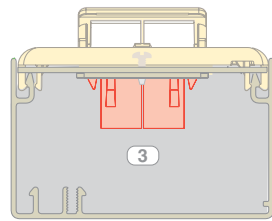

A = 3.47 in.²

Cable fill #3: Communication pole using vertical sloped snap-on communication faceplate.

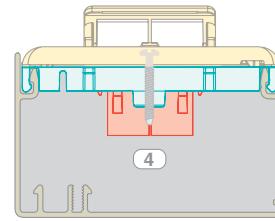

A = 2.83 in.²

Cable fill #4: communication pole using sloped screw-on communication faceplate.

SPEC = 40% cable fill – The recommended design in cable capacity, leaves room for future moves, adds, and changes.

MAX for Data = 60% cable fill – The maximum cable quantity based on cable interweaving and packing factors.

MAX for Power cable fill – The maximum of electrical cables based on UL temperature rise test.

	Raceway Type and Configuration	Fill Area (In. ²)	Electrical Cables			Data Grade Cables		Data Grade Cables		Audio/Video		Fiber Optic Cable	
			14 AWG	12 AWG	10 AWG	24 AWG/UTP CM		24 AWG/UTP CM		RG6		2 Strand	
			THHN/T90			Cat. 6 (4-pr.)		Augmented Cat. 6					
			0.111	0.130	0.164	DIA. = 0.250		DIA. = 0.354		DIA. = 0.275		DIA. = 0.175	
			FILL			FILL		FILL		FILL		FILL	
			MAX	MAX	MAX	SPEC	MAX	SPEC	MAX	SPEC	MAX	SPEC	MAX
			(UL Temp Rise Test)			(40%)	(60%)	(40%)	(60%)	(40%)	(60%)	(40%)	(60%)
1A.	Power and communication: snap-on faceplates (power).	0.47	—	11	—	—	—	—	—	32	4	7	11
1B.	Communication.	2.75	—	—	—	22	33	12	19	18	27	45	68
2A.	Power and communication: Screw-on faceplates (power).	0.43	—	11	—	—	—	—	—	2	4	7	10
2B.	Communication.	2.15	—	—	—	17	26	10	15	14	21	35	53
3.	Communication only Snap-on faceplate.	3.47	—	—	—	28	42	16	24	23	35	57	86
4.	Communication only: Screw-on faceplates.	2.83	—	—	—	23	34	13	19	19	28	47	70

AWG dimensions represent typical outer cable diameter in inches.

ABRASION PROTECTION

PANDUIT abrasion protection products provide an economical and easy way to insulate, protect, bundle and color-code components and cable. A wide variety of sizes and materials are available to meet a broad range of indoor and outdoor applications. To help assure optimum quality, *PANDUIT* abrasion protection products are designed and manufactured to meet applicable quality standards including International, UL, Military, ISO and Aerospace.



- *PAN-WRAP™* Split Harness Wrap features a patented slot pattern to improve flexibility and abrasion protection
- Spiral wrap bundles and protects wire and cable while providing the largest variety of colors, materials, and sizes to meet a variety of needs
- Grommet edging protects wire and cable from damage caused by sharp panel edges
- Heat shrink is available in many different materials and sizes to meet a variety of needs
- Corrugated loom tubing is crush, impact, and abrasion resistant to reduce the risk of damage to wire and cable
- Braided expandable sleeving provides continuous abrasion resistance and lightweight durable protection, with a flexible open weave that will not trap heat or humidity

PANDUIT abrasion protection products provide quality at the lowest installed cost. With a continued focus on new product development, *PANDUIT* continues to meet customer needs.

A.
System
Overview

B1.
Cable Ties

B2.
Cable
Accessories

B3.
Stainless
Steel Ties

C1.
Wiring
Duct

C2.
Surface
Raceway

C3.
Abrasion
Protection

C4.
Cable
Management

D1.
Terminals

D2.
Power
Connectors

D3.
Grounding
Connectors

E1.
Labeling
Systems

E2.
Labels

E3.
Pre-Printed
& Write-On
Markers

E4.
Permanent
Identification

E5.
Lockout/
Tagout
& Safety
Solutions

F.
Index

A. System Overview

PAN-WRAP™ Split Harness Wrap

B1. Cable Ties

- Patented slot pattern provides improved flexibility and abrasion protection in any application
- Unique wall design provides for easy cable breakouts
- Innovative design maintains uniform bundle protection in dynamic applications
- Large overlap accommodates a wide range of bundle diameters
- Packaged on a reel for easy handling and dispensing of product

B2. Cable Accessories



B3. Stainless Steel Ties

C1. Wiring Duct

C2. Surface Raceway

C3. Abrasion Protection

C4. Cable Management

D1. Terminals

D2. Power Connectors

D3. Grounding Connectors

E1. Labeling Systems

E2. Labels

E3. Pre-Printed & Write-On Markers

E4. Permanent Identification

E5. Lockout/Tagout & Safety Solutions

F. Index

Part Number	Material	Color	Length Per Reel		Max. Bundle Diameter		Min. Bundle Diameter‡		Temperature Range	Nominal I.D.		Std. Pkg. Qty.*
			Ft.	m	In.	mm	In.	mm		In.	mm	
PW50F-T	Polyethylene	Natural	200	61.1	.55	14.0	.43	10.9	-40°F to 122°F (-40°C to 50°C)	.50	12.7	1
PW50F-T20	Polyethylene	Black	200	61.1	.55	14.0	.43	10.9	-40°F to 122°F (-40°C to 50°C)	.50	12.7	1
PW50FR-T	Flame Retardant Polyethylene	Natural	200	61.1	.55	14.0	.43	10.9	-4°F to 212°F (-20°C to 100°C)	.50	12.7	1
PW50FR-T20	Flame Retardant Polyethylene	Black	200	61.1	.55	14.0	.43	10.9	-4°F to 212°F (-20°C to 100°C)	.50	12.7	1
PW75F-C	Polyethylene	Natural	100	30.5	.81	20.6	.55	14.0	-40°F to 122°F (-40°C to 50°C)	.75	19.1	1
PW75F-C20	Polyethylene	Black	100	30.5	.81	20.6	.55	14.0	-40°F to 122°F (-40°C to 50°C)	.75	19.1	1
PW75FR-C	Flame Retardant Polyethylene	Natural	100	30.5	.81	20.6	.55	14.0	-4°F to 212°F (-20°C to 100°C)	.75	19.1	1
PW75FR-C20	Flame Retardant Polyethylene	Black	100	30.5	.81	20.6	.55	14.0	-4°F to 212°F (-20°C to 100°C)	.75	19.1	1
PW100F-C	Polyethylene	Natural	100	30.5	1.13	28.7	.81	20.6	-40°F to 122°F (-40°C to 50°C)	1.00	25.4	1
PW100F-C20	Polyethylene	Black	100	30.5	1.13	28.7	.81	20.6	-40°F to 122°F (-40°C to 50°C)	1.00	25.4	1
PW100FR-C	Flame Retardant Polyethylene	Natural	100	30.5	1.13	28.7	.81	20.6	-4°F to 212°F (-20°C to 100°C)	1.00	25.4	1
PW100FR-C20	Flame Retardant Polyethylene	Black	100	30.5	1.13	28.7	.81	20.6	-4°F to 212°F (-20°C to 100°C)	1.00	25.4	1
PW150F-L	Polyethylene	Natural	25	7.6	1.63	41.4	1.13	28.7	-40°F to 122°F (-40°C to 50°C)	1.50	38.1	1
PW150F-L20	Polyethylene	Black	25	7.6	1.63	41.4	1.13	28.7	-40°F to 122°F (-40°C to 50°C)	1.50	38.1	1
PW150FR-L	Flame Retardant Polyethylene	Natural	25	7.6	1.63	41.4	1.13	28.7	-40°F to 122°F (-40°C to 50°C)	1.50	38.1	1
PW150FR-L20	Flame Retardant Polyethylene	Black	25	7.6	1.63	41.4	1.13	28.7	-40°F to 122°F (-40°C to 50°C)	1.50	38.1	1

‡Diameter can be further reduced with the use of *PANDUIT* cable ties.
*Order number of reels required.

PAN-WRAP™ Installation Tools

- Patented installation tool with 180° opening allows easy loading of maximum bundle diameters to speed installation, providing the lowest installed cost



Part Number	Color	For Use With	Std. Pkg. Qty.**
PWT50	White	PW50F-	1
PWT75	White	PW75F-	1
PWT100	White	PW100F-	1
PWT150	White	PW150F-	1

**Order number of tools required.

Part Number System for Spiral Wrap

T	25	F	-	C	16
Type	Outside Diameter	Material		Package Size	Color Suffix
T = Spiral Wrap	12 = 1/8"	F = Polyethylene		X = 10'	See Table Below
	25 = 1/4"	R = Fire Resistant Polyethylene		Q = 25'	
	38 = 3/8"	FR = Flame Retardant Polyethylene		L = 50'	
	50 = 1/2"	N = Nylon		C = 100'	
	62 = 5/8"	T = TEFLON▲		T = 200'	
	75 = 3/4"			TL = 250'	
	100 = 1"			D = 500'	
				M = 1000'	

Color	Color Suffix	MATERIAL AVAILABILITY				
		Polyethylene	Fire Resistant Polyethylene	Flame Retardant Polyethylene	Nylon 6.6	TEFLON▲
Natural*	No Suffix will be listed	✓	✓*	✓*	✓	✓
Weather Resistant Black	0	✓			✓	
Brown	1	✓				
Red	2	✓				
Orange	3	✓				
Yellow	4	✓				
Green	5	✓				
Blue	6	✓				
Purple	7	✓				
Gray	8	✓				
White	10	✓				
Pink	16	✓				
Black	20	✓	✓	✓		

Blank = Not applicable.

▲TEFLON or equivalent fluoropolymer PTFE material is used. TEFLON is a registered trademark of E.I. du Pont de Nemours and Company.

*Natural can range from transparent, opaque, to white.

- A. System Overview
- B1. Cable Ties
- B2. Cable Accessories
- B3. Stainless Steel Ties
- C1. Wiring Duct
- C2. Surface Raceway
- C3. Abrasion Protection
- C4. Cable Management
- D1. Terminals
- D2. Power Connectors
- D3. Grounding Connectors
- E1. Labeling Systems
- E2. Labels
- E3. Pre-Printed & Write-On Markers
- E4. Permanent Identification
- E5. Lockout/Tagout & Safety Solutions
- F. Index

A. System Overview

Spiral Wrap

B1. Cable Ties



B2. Cable Accessories

- Harness multiple cables into a single manageable bundle
- Allows breakouts of single/multiple cables
- Provides protection for cables
- Multiple colors allow easy identification of cable bundles
- Installation tool supplied in each package

B3. Stainless Steel Ties

C1. Wiring Duct

C2. Surface Raceway

C3. Abrasion Protection

C4. Cable Management

D1. Terminals

D2. Power Connectors

D3. Grounding Connectors

E1. Labeling Systems

E2. Labels

E3. Pre-Printed & Write-On Markers

E4. Permanent Identification

E5. Lockout/Tagout & Safety Solutions

F. Index

Part Number	Material*	Color	Length per Reel		Bundle Diameter Range		Outside Diameter		Temperature Range	Wall Thickness		Std. Pkg. Qty.
			Ft.	m	In.	mm	In.	mm		In.	mm	
T12F-C	Polyethylene	Natural	100	30.5	1/16 to 1/2	1.6 to 12.7	.12	3.3	-40°F to 122°F (-40°C to 50°C)	.03	.76	1
T19F-C	Polyethylene	Natural	100	30.5	1/8 to 1	3.2 to 25.4	.19	4.8	-40°F to 122°F (-40°C to 50°C)	.03	.89	1
T25F-C	Polyethylene	Natural	100	30.5	3/16 to 2	4.8 to 50.4	.25	6.4	-40°F to 122°F (-40°C to 50°C)	.04	1.02	1
T25F-C1	Polyethylene	Brown	100	30.5	3/16 to 2	4.8 to 50.4	.25	6.4	-40°F to 122°F (-40°C to 50°C)	.04	1.02	1
T25F-C10	Polyethylene	White	100	30.5	3/16 to 2	4.8 to 50.4	.25	6.4	-40°F to 122°F (-40°C to 50°C)	.04	1.02	1
T25F-C16	Polyethylene	Pink	100	30.5	3/16 to 2	4.8 to 50.4	.25	6.4	-40°F to 122°F (-40°C to 50°C)	.04	1.02	1
T25F-C2	Polyethylene	Red	100	30.5	3/16 to 2	4.8 to 50.4	.25	6.4	-40°F to 122°F (-40°C to 50°C)	.04	1.02	1
T25F-C3Y	Polyethylene	Orange	100	30.5	3/16 to 2	4.8 to 50.4	.25	6.4	-40°F to 122°F (-40°C to 50°C)	.04	1.02	1
T25F-C4Y	Polyethylene	Yellow	100	30.5	3/16 to 2	4.8 to 50.4	.25	6.4	-40°F to 122°F (-40°C to 50°C)	.04	1.02	1
T25F-C5	Polyethylene	Green	100	30.5	3/16 to 2	4.8 to 50.4	.25	6.4	-40°F to 122°F (-40°C to 50°C)	.04	1.02	1
T25F-C6	Polyethylene	Blue	100	30.5	3/16 to 2	4.8 to 50.4	.25	6.4	-40°F to 122°F (-40°C to 50°C)	.04	1.02	1
T25F-C7	Polyethylene	Purple	100	30.5	3/16 to 2	4.8 to 50.4	.25	6.4	-40°F to 122°F (-40°C to 50°C)	.04	1.02	1
T25F-C8	Polyethylene	Gray	100	30.5	3/16 to 2	4.8 to 50.4	.25	6.4	-40°F to 122°F (-40°C to 50°C)	.04	1.02	1
T38F-C	Polyethylene	Natural	100	30.5	5/16 to 3	7.9 to 76.2	.38	9.5	-40°F to 122°F (-40°C to 50°C)	.05	1.40	1
T50F-X	Polyethylene	Natural	10	3.05	3/8 to 4	9.5 to 101.6	.50	12.7	-40°F to 122°F (-40°C to 50°C)	.06	1.50	1
T50F-C	Polyethylene	Natural	100	30.5	3/8 to 4	9.5 to 101.6	.50	12.7	-40°F to 122°F (-40°C to 50°C)	.06	1.50	1
T50F-C1	Polyethylene	Brown	100	30.5	3/8 to 4	9.5 to 101.6	.50	12.7	-40°F to 122°F (-40°C to 50°C)	.06	1.50	1
T50F-C10	Polyethylene	White	100	30.5	3/8 to 4	9.5 to 101.6	.50	12.7	-40°F to 122°F (-40°C to 50°C)	.06	1.50	1
T50F-C16	Polyethylene	Pink	100	30.5	3/8 to 4	9.5 to 101.6	.50	12.7	-40°F to 122°F (-40°C to 50°C)	.06	1.50	1

*Flame retardant products are manufactured from a material that is rated UL 94V-0.
 ‡Reel packaging may contain splices. Contact PANDUIT Customer Service for further information.

Spiral Wrap (continued)

Part Number	Material*	Color	Length per Reel		Bundle Diameter Range		Outside Diameter		Temperature Range	Wall Thickness		Std. Pkg. Qty.
			Ft.	m	In.	mm	In.	mm		In.	mm	
T50F-C2	Polyethylene	Red	100	30.5	3/8 to 4	9.5 to 101.6	.50	12.7	-40°F to 122°F (-40°C to 50°C)	.06	1.50	1
T50F-C3Y	Polyethylene	Orange	100	30.5	3/8 to 4	9.5 to 101.6	.50	12.7	-40°F to 122°F (-40°C to 50°C)	.06	1.50	1
T50F-C4Y	Polyethylene	Yellow	100	30.5	3/8 to 4	9.5 to 101.6	.50	12.7	-40°F to 122°F (-40°C to 50°C)	.06	1.50	1
T50F-C5	Polyethylene	Green	100	30.5	3/8 to 4	9.5 to 101.6	.50	12.7	-40°F to 122°F (-40°C to 50°C)	.06	1.50	1
T50F-C6	Polyethylene	Blue	100	30.5	3/8 to 4	9.5 to 101.6	.50	12.7	-40°F to 122°F (-40°C to 50°C)	.06	1.50	1
T50F-C7	Polyethylene	Purple	100	30.5	3/8 to 4	9.5 to 101.6	.50	12.7	-40°F to 122°F (-40°C to 50°C)	.06	1.50	1
T50F-C8	Polyethylene	Gray	100	30.5	3/8 to 4	9.5 to 101.6	.50	12.7	-40°F to 122°F (-40°C to 50°C)	.06	1.50	1
T62F-C	Polyethylene	Natural	100	30.5	1/2 to 4 1/2	12.7 to 114.3	.62	15.9	-40°F to 122°F (-40°C to 50°C)	.06	1.57	1
T75F-C	Polyethylene	Natural	100	30.5	5/8 to 5	15.9 to 127.0	.75	19.1	-40°F to 122°F (-40°C to 50°C)	.06	1.65	1
T100F-C	Polyethylene	Natural	100	30.5	7/8 to 6	22.2 to 152.4	1.00	25.4	-40°F to 122°F (-40°C to 50°C)	.07	1.78	1
T12F-C0	Weather Resistant Polyethylene	Black	100	30.5	1/16 to 1/2	1.6 to 12.7	.12	3.3	-40°F to 122°F (-40°C to 50°C)	.03	.76	1
T19F-C0	Weather Resistant Polyethylene	Black	100	30.5	1/8 to 1	3.2 to 25.4	.19	4.8	-40°F to 122°F (-40°C to 50°C)	.03	.89	1
T25F-X0	Weather Resistant Polyethylene	Black	10	3.05	3/16 to 2	4.8 to 50.4	.25	6.4	-40°F to 122°F (-40°C to 50°C)	.04	1.02	1
T25F-C0	Weather Resistant Polyethylene	Black	100	30.5	3/16 to 2	4.8 to 50.4	.25	6.4	-40°F to 122°F (-40°C to 50°C)	.04	1.02	1
T38F-C0	Weather Resistant Polyethylene	Black	100	30.5	5/16 to 3	7.9 to 76.2	.38	9.5	-40°F to 122°F (-40°C to 50°C)	.05	1.40	1
T50F-X0	Weather Resistant Polyethylene	Black	10	3.05	3/8 to 4	9.5 to 101.6	.50	12.7	-40°F to 122°F (-40°C to 50°C)	.06	1.50	1
T50F-C0	Weather Resistant Polyethylene	Black	100	30.5	3/8 to 4	9.5 to 101.6	.50	12.7	-40°F to 122°F (-40°C to 50°C)	.06	1.50	1
T62F-C0	Weather Resistant Polyethylene	Black	100	30.5	1/2 to 4 1/2	12.7 to 114.3	.62	15.9	-40°F to 122°F (-40°C to 50°C)	.06	1.57	1
T75F-C0	Weather Resistant Polyethylene	Black	100	30.5	5/8 to 5	15.9 to 127.0	.75	19.1	-40°F to 122°F (-40°C to 50°C)	.06	1.65	1
T100F-C0	Weather Resistant Polyethylene	Black	100	30.5	7/8 to 6	22.2 to 152.4	1.00	25.4	-40°F to 122°F (-40°C to 50°C)	.07	1.78	1
T12R-CY	Fire Resistant Polyethylene	Natural	100	30.5	1/16 to 1/2	1.6 to 12.7	.12	3.3	-40°F to 122°F (-40°C to 50°C)	.03	.76	1
T19R-CY	Fire Resistant Polyethylene	Natural	100	30.5	1/8 to 1	3.2 to 25.4	.19	4.8	-40°F to 122°F (-40°C to 50°C)	.03	.89	1
T25R-CY	Fire Resistant Polyethylene	White	100	30.5	3/16 to 2	4.8 to 50.4	.25	6.4	-40°F to 122°F (-40°C to 50°C)	.04	1.02	1
T25R-C20Y	Fire Resistant Polyethylene	Black	100	30.5	3/16 to 2	4.8 to 50.4	.25	6.4	-40°F to 122°F (-40°C to 50°C)	.04	1.02	1
T38R-CY	Fire Resistant Polyethylene	White	100	30.5	5/16 to 3	7.9 to 76.2	.38	9.5	-40°F to 122°F (-40°C to 50°C)	.05	1.40	1
T50R-CY	Fire Resistant Polyethylene	White	100	30.5	3/8 to 4	9.5 to 101.6	.50	12.7	-40°F to 122°F (-40°C to 50°C)	.06	1.50	1

*Flame retardant products are manufactured from a material that is rated UL 94V-0.

†Reel packaging may contain splices. Contact PANDUIT Customer Service for further information.

Table continues on page C3.6

A. System Overview

Spiral Wrap (continued)

B1. Cable Ties

B2. Cable Accessories

B3. Stainless Steel Ties

C1. Wiring Duct

C2. Surface Raceway

C3. Abrasion Protection

C4. Cable Management

D1. Terminals

D2. Power Connectors

D3. Grounding Connectors

E1. Labeling Systems

E2. Labels

E3. Pre-Printed & Write-On Markers

E4. Permanent Identification

E5. Lockout/Tagout & Safety Solutions

F. Index

Part Number	Material*	Color	Length per Reel		Bundle Diameter Range		Outside Diameter		Temperature Range	Wall Thickness		Std. Pkg. Qty.
			Ft.	m	In.	mm	In.	mm		In.	mm	
T62R-CY	Fire Resistant Polyethylene	White	100	30.5	1/2 to 4 1/2	12.7 to 114.3	.62	15.9	-40°F to 122°F (-40°C to 50°C)	.06	.63	1
T75R-CY	Fire Resistant Polyethylene	White	100	30.5	5/8 to 5	15.9 to 127.0	.75	19.1	-40°F to 122°F (-40°C to 50°C)	.07	1.65	1
T100R-CY	Fire Resistant Polyethylene	White	100	30.5	7/8 to 6	22.2 to 152.4	1.00	25.4	-40°F to 122°F (-40°C to 50°C)	.07	1.78	1
T12FR-C	Flame Retardant Polyethylene	White	100	30.5	1/16 to 1/2	1.6 to 12.7	.12	3.3	-4°F to 212°F (-20°C to 100°C)	.03	.76	1
T12FR-C20	Flame Retardant Polyethylene	Black	100	30.5	1/16 to 1/2	1.6 to 12.7	.12	3.3	-4°F to 212°F (-20°C to 100°C)	.03	.76	1
T19FR-C	Flame Retardant Polyethylene	White	100	30.5	1/8 to 1	3.2 to 25.4	.19	4.8	-4°F to 212°F (-20°C to 100°C)	.03	.89	1
T19FR-C20	Flame Retardant Polyethylene	Black	100	30.5	1/8 to 1	3.2 to 25.4	.19	4.8	-4°F to 212°F (-20°C to 100°C)	.03	.89	1
T25FR-C	Flame Retardant Polyethylene	White	100	30.5	3/16 to 2	4.8 to 50.4	.25	6.4	-4°F to 212°F (-20°C to 100°C)	.04	1.02	1
T25FR-C20	Flame Retardant Polyethylene	Black	100	30.5	3/16 to 2	4.8 to 50.4	.25	6.4	-4°F to 212°F (-20°C to 100°C)	.04	1.02	1
T38FR-C	Flame Retardant Polyethylene	White	100	30.5	5/16 to 3	7.9 to 76.2	.38	9.5	-4°F to 212°F (-20°C to 100°C)	.05	1.40	1
T38FR-C20	Flame Retardant Polyethylene	Black	100	30.5	5/16 to 3	7.9 to 76.2	.38	9.5	-4°F to 212°F (-20°C to 100°C)	.05	1.40	1
T50FR-C	Flame Retardant Polyethylene	White	100	30.5	3/8 to 4	9.5 to 101.6	.50	12.7	-4°F to 212°F (-20°C to 100°C)	.06	1.50	1
T50FR-C20	Flame Retardant Polyethylene	Black	100	30.5	3/8 to 4	9.5 to 101.6	.50	12.7	-4°F to 212°F (-20°C to 100°C)	.06	1.50	1
T62FR-C	Flame Retardant Polyethylene	White	100	30.5	1/2 to 4 1/2	12.7 to 114.3	.62	15.9	-4°F to 212°F (-20°C to 100°C)	.06	1.57	1
T62FR-C20	Flame Retardant Polyethylene	Black	100	30.5	1/2 to 4 1/2	12.7 to 114.3	.62	15.9	-4°F to 212°F (-20°C to 100°C)	.06	1.57	1
T75FR-C	Flame Retardant Polyethylene	White	100	30.5	5/8 to 5	15.9 to 127.0	.75	19.1	-4°F to 212°F (-20°C to 100°C)	.06	1.65	1
T75FR-C20	Flame Retardant Polyethylene	Black	100	30.5	5/8 to 5	15.9 to 127.0	.75	19.1	-4°F to 212°F (-20°C to 100°C)	.06	1.65	1
T100FR-C	Flame Retardant Polyethylene	White	100	30.5	7/8 to 6	22.2 to 152.4	1.00	25.4	-4°F to 212°F (-20°C to 100°C)	.07	1.78	1
T100FR-C20	Flame Retardant Polyethylene	Black	100	30.5	7/8 to 6	22.2 to 152.4	1.00	25.4	-4°F to 212°F (-20°C to 100°C)	.07	1.78	1
T12N-C	Nylon 6.6	Natural	100	30.5	1/16 to 1/2	1.6 to 12.7	.12	3.3	-40°F to 149°F (-40°C to 65°C)	.03	.76	1
T19N-C	Nylon 6.6	Natural	100	30.5	3/16 to 2	4.8 to 50.4	.25	6.4	-40°F to 149°F (-40°C to 65°C)	.04	1.02	1
T25N-C	Nylon 6.6	Natural	100	30.5	1/8 to 1	3.2 to 25.4	.19	4.8	-40°F to 149°F (-40°C to 65°C)	.03	.89	1
T38N-C	Nylon 6.6	Natural	100	30.5	5/16 to 3	7.9 to 76.2	.38	9.7	-40°F to 149°F (-40°C to 65°C)	.05	1.40	1

*Flame retardant products are manufactured from a material that is rated UL 94V-0.
 ‡Reel packaging may contain splices. Contact *PANDUIT* Customer Service for further information.

Spiral Wrap (continued)

Part Number	Material*	Color	Length per Reel		Bundle Diameter Range		Outside Diameter		Temperature Range	Wall Thickness		Std. Pkg. Qty.
			Ft.	m	In.	mm	In.	mm		In.	mm	
T50N-C	Nylon 6.6	Natural	100	30.5	3/8 to 4	9.5 to 101.6	.50	12.7	-40°F to 149°F (-40°C to 65°C)	.06	1.50	1
T62N-C	Nylon 6.6	Natural	100	30.5	1/2 to 4 1/2	12.7 to 114.3	.62	15.9	-40°F to 149°F (-40°C to 65°C)	.06	1.57	1
T75N-C	Nylon 6.6	Natural	100	30.5	5/8 to 5	15.9 to 127.0	.75	19.1	-40°F to 149°F (-40°C to 65°C)	.06	1.65	1
T100N-C	Nylon 6.6	Natural	100	30.5	7/8 to 6	22.2 to 152.4	1.00	25.4	-40°F to 149°F (-40°C to 65°C)	.07	1.78	1
T12N-C0	Weather Resistant Nylon 6.6	Black	100	30.5	1/16 to 1/2	1.6 to 12.7	.12	3.3	-40°F to 149°F (-40°C to 65°C)	.03	.76	1
T19N-C0	Weather Resistant Nylon 6.6	Black	100	30.5	1/8 to 1	3.2 to 25.4	.19	4.8	-40°F to 149°F (-40°C to 65°C)	.03	.89	1
T25N-C0	Weather Resistant Nylon 6.6	Black	100	30.5	3/16 to 2	4.8 to 50.4	.25	6.4	-40°F to 149°F (-40°C to 65°C)	.04	1.02	1
T38N-C0	Weather Resistant Nylon 6.6	Black	100	30.5	5/16 to 3	7.9 to 76.2	.38	9.7	-40°F to 149°F (-40°C to 65°C)	.05	1.40	1
T50N-C0	Weather Resistant Nylon 6.6	Black	100	30.5	3/8 to 4	9.5 to 101.6	.50	12.7	-40°F to 149°F (-40°C to 65°C)	.06	1.50	1
T62N-C0	Weather Resistant Nylon 6.6	Black	100	30.5	1/2 to 4 1/2	12.7 to 114.3	.62	15.9	-40°F to 149°F (-40°C to 65°C)	.06	1.57	1
T75N-C0	Weather Resistant Nylon 6.6	Black	100	30.5	5/8 to 5	15.9 to 127.0	.75	19.1	-40°F to 149°F (-40°C to 65°C)	.06	1.65	1
T100N-C0	Weather Resistant Nylon 6.6	Black	100	30.5	7/8 to 6	22.2 to 152.4	1.00	25.4	-40°F to 149°F (-40°C to 65°C)	.07	1.78	1
T12T-C	TEFLON*	Natural	100	30.5	1/16 to 1/2	1.6 to 12.7	.12	3.2	-40°F to 500°F (-40°C to 260°C)	.03	.76	1
T19T-C	TEFLON*	Natural	100	30.5	1/8 to 1	3.2 to 25.4	.19	4.8	-40°F to 500°F (-40°C to 260°C)	.03	.89	1
T25T-L	TEFLON*	Natural	50	15.2	3/16 to 2	4.8 to 50.4	.25	6.4	-40°F to 500°F (-40°C to 260°C)	.04	1.02	1
T50T-Q	TEFLON*	Natural	25	7.6	3/8 to 4	9.5 to 101.6	.50	12.7	-40°F to 500°F (-40°C to 260°C)	.06	1.50	1
T62T-Q	TEFLON*	Natural	25	7.6	1/2 to 4 1/2	12.7 to 114.3	.62	15.9	-40°F to 500°F (-40°C to 260°C)	.06	1.57	1
T75T-X	TEFLON*	Natural	10	3.05	5/8 to 5	15.9 to 127.0	.75	19.1	-40°F to 500°F (-40°C to 260°C)	.06	1.65	1
T100T-X	TEFLON*	Natural	10	3.05	7/8 to 6	22.2 to 152.4	1.00	25.4	-40°F to 500°F (-40°C to 260°C)	.07	1.78	1

*Flame retardant products are manufactured from a material that is rated UL 94V-0.

‡Reel packaging may contain splices. Contact PANDUIT Customer Service for further information.

*TEFLON or equivalent fluoropolymer PTFE material is used. TEFLON is a registered trademark of E.I. du Pont de Nemours and Company.

A.
System
Overview

B1.
Cable Ties

B2.
Cable
Accessories

B3.
Stainless
Steel Ties

C1.
Wiring
Duct

C2.
Surface
Raceway

C3.
Abrasion
Protection

C4.
Cable
Management

D1.
Terminals

D2.
Power
Connectors

D3.
Grounding
Connectors

E1.
Labeling
Systems

E2.
Labels

E3.
Pre-Printed
& Write-On
Markers

E4.
Permanent
Identification

E5.
Lockout/
Tagout
& Safety
Solutions

F.
Index

A. System Overview

Part Number System for Grommet Edging

B1. Cable Ties

GEE

36

F

-

A

-

C

0

B2. Cable Accessories

Type

Max. Panel Thickness

Material

Adhesive

Package Size

Color Suffix

GE = Grommet Edging Strips
 GEE = Slotted Grommet Edging
 GES = Solid Grommet Edging

36 = .036" thickness
 62 = .062" thickness
 99 = .099" thickness
 144 = .144" thickness
 189 = .189" thickness

F = Polyethylene
 N = Nylon 6.6
 FR = Flame Retardant Polyethylene

A = Adhesive Lined
 Leave Blank = Non-Adhesive

Q = 25'
 L = 50'
 C = 100'

0 = Weather Resistant Black
 Leave Blank = Natural

B3. Stainless Steel Ties

C1. Wiring Duct

C2. Surface Raceway

C3. Abrasion Protection

Grommet Edging

- Use product on irregularly shaped and round panel hole
- Provided in .030 inch (.8mm) thick material making it highly flexible

C4. Cable Management

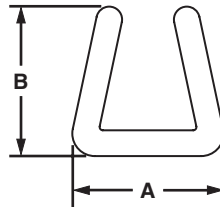
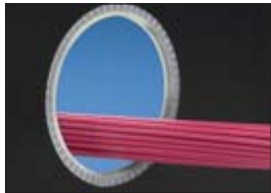

D1. Terminals

D2. Power Connectors

D3. Grounding Connectors

Part Number	Width A		Height B		Panel Thickness Range		Material	Color	Temperature Range	Std. Pkg. Qty.‡
	In.	mm	In.	mm	In.	mm				
Slotted										
GEE36F-C	.11	2.7	.12	3.0	.026 – .036	0.7 – 0.9	Polyethylene	Natural	-40°F to 122°F (-40°C to 50°C)	1
GEE36F-C0	.11	2.7	.12	3.0	.026 – .036	0.7 – 0.9	Weather Resistant Polyethylene	Black		1
GEE62F-C	.13	3.3	.16	4.1	.036 – .062	0.9 – 1.6	Polyethylene	Natural		1
GEE62F-C0	.13	3.3	.16	4.1	.036 – .062	0.9 – 1.6	Weather Resistant Polyethylene	Black		1
GEE99F-C	.17	4.3	.19	4.7	.062 – .099	1.6 – 2.5	Polyethylene	Natural		1
GEE99F-C0	.17	4.3	.19	4.7	.062 – .099	1.6 – 2.5	Weather Resistant Polyethylene	Black		1
GEE144F-C	.21	5.3	.22	5.6	.099 – .144	2.5 – 3.7	Polyethylene	Natural		1
GEE144F-C0	.22	5.3	.22	5.6	.099 – .144	2.5 – 3.7	Weather Resistant Polyethylene	Black		1

‡Reel packaging may contain splices. Contact PANDUIT Customer Service for further information.

E5. Lockout/Tagout & Safety Solutions

F. Index

Grommet Edging (continued)

Part Number	Width A		Height B		Panel Thickness Range		Material	Color	Temperature Range	Std. Pkg. Qty.‡
	In.	mm	In.	mm	In.	mm				
Solid										
GES36F-C	.11	2.8	.12	3.1	.026 – .036	0.7 – 0.9	Polyethylene	Natural	-40°F to 122°F (-40°C to 50°C)	1
GES36F-C0	.11	2.8	.12	3.1	.026 – .036	0.7 – 0.9	Weather Resistant Polyethylene	Black		1
GES62F-C	.13	3.3	.16	4.1	.036 – .062	0.9 – 1.6	Polyethylene	Natural		1
GES62F-C0	.13	3.3	.16	4.1	.036 – .062	0.9 – 1.6	Weather Resistant Polyethylene	Black		1
GES99F-C	.17	4.3	.19	4.8	.062 – .099	1.6 – 2.5	Polyethylene	Natural		1
GES99F-C0	.17	4.3	.19	4.8	.062 – .099	1.6 – 2.5	Weather Resistant Polyethylene	Black		1
GES144F-C	.21	5.3	.22	5.6	.099 – .144	2.5 – 3.7	Polyethylene	Natural		1
GES144F-C0	.21	5.3	.22	5.6	.099 – .144	2.5 – 3.7	Weather Resistant Polyethylene	Black		1
GES189F-C	.30	7.6	.30	7.6	.144 – .189	3.7 – 4.8	Polyethylene	Natural		1
GES189F-C0	.30	7.6	.30	7.6	.144 – .189	3.7 – 4.8	Weather Resistant Polyethylene	Natural		1
Slotted Adhesive Lined										
GEE62F-A-C	.13	3.3	.16	4.1	.036 – .062	0.9 – 1.6	Polyethylene	Natural	-40°F to 122°F (-40°C to 50°C)	1
GEE62F-A-C0	.13	3.3	.16	4.1	.036 – .062	0.9 – 1.6	Weather Resistant Polyethylene	Black		1
GEE99F-A-C	.17	4.3	.19	4.7	.062 – .099	1.6 – 2.5	Polyethylene	Natural		1
GEE99F-A-C0	.17	4.3	.19	4.7	.062 – .099	1.6 – 2.5	Weather Resistant Polyethylene	Black		1
GEE144F-A-C	.21	5.3	.22	5.6	.099 – .144	2.5 – 3.7	Polyethylene	Natural		1
GEE144F-A-C0	.21	5.3	.22	5.6	.099 – .144	2.5 – 3.7	Weather Resistant Polyethylene	Black		1
Solid Adhesive Lined										
GES62F-A-C	.13	3.3	.16	4.1	.036 – .062	0.9 – 1.6	Polyethylene	Natural	-40°F to 122°F (-40°C to 50°C)	1
GES62F-A-C0	.13	3.3	.16	4.1	.036 – .062	0.9 – 1.6	Weather Resistant Polyethylene	Black		1
GES99F-A-C	.17	4.3	.19	4.8	.062 – .099	1.6 – 2.5	Polyethylene	Natural		1
GES99F-A-C0	.17	4.3	.19	4.8	.062 – .099	1.6 – 2.5	Weather Resistant Polyethylene	Black		1
GES144F-A-C	.21	5.3	.22	5.6	.099 – .144	2.5 – 3.7	Polyethylene	Natural		1
GES144F-A-C0	.21	5.3	.22	5.6	.099 – .144	2.5 – 3.7	Weather Resistant Polyethylene	Black		1
Slotted Flame Retardant										
GEE36FR-C	.11	2.7	.12	4.1	.036 – .062	0.9 – 1.6	Flame Retardant Polyethylene	Natural	-40°F to 194°F (-40°C to 90°C)	1
GEE62FR-C	.13	3.3	.160	4.1	.036 – .062	0.9 – 1.6	Flame Retardant Polyethylene	Natural		1
GEE99FR-C	.17	4.3	.160	3.9	.062 – .099	1.6 – 2.5	Flame Retardant Polyethylene	Natural		1
GEE144FR-C	.21	5.3	.222	5.9	.099 – .144	2.5 – 3.7	Flame Retardant Polyethylene	Natural		1

‡Reel packaging may contain splices. Contact PANDUIT Customer Service for further information.

Table continues on page C3.10

A.
System
Overview

Grommet Edging (continued)

B1.
Cable Ties

Part Number	Width A		Height B		Panel Thickness Range		Material	Color	Temperature Range	Std. Pkg. Qty.‡
	In.	mm	In.	mm	In.	mm				

B2.
Cable
Accessories

Solid Flame Retardant

GES36FR-C	.11	2.8	.12	3.1	.036 – .062	0.9 – 1.6	Polyethylene	Natural	-40°F to 122°F (-40°C to 50°C)	1
GES62FR-C	.13	3.3	.16	4.1	.036 – .062	0.9 – 1.6	Flame Retardant Polyethylene	Natural	-40°F to 194°F (-40°C to 90°C)	1
GES99FR-C	.17	4.3	.19	4.8	.062 – .099	1.6 – 2.5	Flame Retardant Polyethylene	Natural		1
GES144FR-C	.21	5.3	.22	5.6	.099 – .144	2.5 – 3.7	Flame Retardant Polyethylene	Natural		1

B3.
Stainless
Steel Ties

C1.
Wiring
Duct

Slotted Nylon

GEE47N-C	.13	3.3	.14	3.5	.039 – .055	1.0 – 1.4	Nylon 6.6	Natural	-40°F to 149°F (-40°C to 65°C)	1
GEE55N-C	.13	3.4	.14	3.5	.047 – .063	1.2 – 1.6	Nylon 6.6	Natural		1
GEE71N-C	.15	3.8	.14	3.5	.063 – .079	1.6 – 2.0	Nylon 6.6	Natural		1
GEE98N-C	.18	4.6	.14	3.5	.091 – .106	2.3 – 2.7	Nylon 6.6	Natural		1
GEE134N-C	.21	5.3	.14	3.5	.126 – .142	3.2 – 3.6	Nylon 6.6	Natural		1

C2.
Surface
Raceway

C3.
Abrasion
Protection

C4.
Cable
Management

Military Standard MS21266 in 12 3/4" Lengths

GE52-C	.15	3.8	.16	3.9	.015 – .052	0.4 – 1.3	Nylon 6.6	Natural	-40°F to 149°F (-40°C to 65°C)	100
GE52-C69	.15	3.8	.16	3.9	.015 – .052	0.4 – 1.3	Flame Retardant Nylon 6.6	Natural		100
GE85-C	.18	4.5	.16	3.9	.052 – .085	1.3 – 2.2	Nylon 6.6	Natural		100
GE85-C69	.18	4.5	.16	3.9	.052 – .085	1.3 – 2.2	Flame Retardant Nylon 6.6	Natural		100
GE128-C	.22	5.6	.16	3.9	.085 – .128	2.2 – 3.3	Nylon 6.6	Natural		100
GE128-C69	.22	5.6	.16	3.9	.085 – .128	2.2 – 3.3	Flame Retardant Nylon 6.6	Natural		100
GE192-L	.33	8.3	.23	5.8	.128 – .192	3.3 – 4.9	Nylon 6.6	Natural		50
GE192-L69	.33	8.3	.23	5.8	.128 – .192	3.3 – 4.9	Flame Retardant Nylon 6.6	Natural		50
GE255-L	.39	9.8	.24	6.1	.192 – .255	4.9 – 6.5	Nylon 6.6	Natural		50
GE318-L	.46	11.3	.26	6.5	.255 – .318	6.5 – 8.1	Nylon 6.6	Natural		50
GE380-Q	.52	13.1	.26	6.5	.318 – .380	8.1 – 9.7	Nylon 6.6	Natural		25
GE510-Q	.64	16.3	.26	6.5	.380 – .510	9.7 – 13.0	Nylon 6.6	Natural		25

‡Reel packaging may contain splices. Contact PANDUIT Customer Service for further information.

E4.
Permanent
Identification

E5.
Lockout/
Tagout/
& Safety
Solutions

F.
Index

Part Number System for Corrugated Loom Tubing

CLT	100	N	-	C	630
Type	Bundle Diameter	Material		Package Size	Color Suffix
CLT = Slit Wall CLTS = Solid Wall	25 = 1/4" 35 = 5/16" 38 = 3/8" 50 = 1/2" 62 = 5/8" 75 = 3/4" 100 = 1" 125 = 1 1/4" 150 = 1 1/2" 188 = 1 7/8"	N = Heat Stabilized Nylon F = Polyethylene		X = 10' L = 50' C = 100' T = 200' D = 500'	630 = Heat Stabilized Black Nylon 6 20 = Black Polyethylene 3 = Orange Polyethylene 4 = Yellow Polyethylene

Corrugated Loom Tubing – Slit

- Provides protection for cables
- Packaged on a reel for easy handling and dispensing of product
- For indoor use only



Part Number	Material	Color	Length per Reel		Inside Diameter		Outside Diameter		Temperature Range	Std. Pkg. Qty.*
			Ft.	m	In.	mm	In.	mm		
CLT25F-C3	Polyethylene	Orange	100	30.5	.27	6.7	.39	9.9	-40°F to 122°F (-40°C to 50°C)	1
CLT25F-C20	Polyethylene	Black	100	30.5	.27	6.7	.39	9.9	-40°F to 122°F (-40°C to 50°C)	1
CLT38F-C3	Polyethylene	Orange	100	30.5	.41	10.5	.56	14.2	-40°F to 122°F (-40°C to 50°C)	1
CLT38F-C20	Polyethylene	Black	100	30.5	.41	10.5	.56	14.2	-40°F to 122°F (-40°C to 50°C)	1
CLT50F-C3	Polyethylene	Orange	100	30.5	.51	12.8	.67	17.0	-40°F to 122°F (-40°C to 50°C)	1
CLT50F-C20	Polyethylene	Black	100	30.5	.51	12.8	.67	17.0	-40°F to 122°F (-40°C to 50°C)	1
CLT75F-C3	Polyethylene	Orange	100	30.5	.76	19.3	.94	23.8	-40°F to 122°F (-40°C to 50°C)	1
CLT75F-C20	Polyethylene	Black	100	30.5	.76	19.3	.94	23.8	-40°F to 122°F (-40°C to 50°C)	1
CLT100F-C3	Polyethylene	Orange	100	30.5	.92	23.2	1.09	27.7	-40°F to 122°F (-40°C to 50°C)	1
CLT100F-C20	Polyethylene	Black	100	30.5	.92	23.2	1.09	27.7	-40°F to 122°F (-40°C to 50°C)	1
CLT125F-L3	Polyethylene	Orange	50	15.2	1.29	32.8	1.50	38.1	-40°F to 122°F (-40°C to 50°C)	1
CLT125F-L4	Polyethylene	Yellow	50	15.2	1.29	32.8	1.50	38.1	-40°F to 122°F (-40°C to 50°C)	1
CLT125F-L20	Polyethylene	Black	50	15.2	1.29	32.8	1.50	38.1	-40°F to 122°F (-40°C to 50°C)	1
CLT150F-T20	Polyethylene	Black	200	61.0	1.55	39.1	1.86	47.2	-40°F to 122°F (-40°C to 50°C)	1
CLT150F-X3	Polyethylene	Orange	10	3.0	1.55	39.1	1.86	47.2	-40°F to 122°F (-40°C to 50°C)	1
CLT150F-X4	Polyethylene	Yellow	10	3.0	1.55	39.1	1.86	47.2	-40°F to 122°F (-40°C to 50°C)	1
CLT150F-X20	Polyethylene	Black	10	3.0	1.55	39.1	1.86	47.2	-40°F to 122°F (-40°C to 50°C)	1
CLT188F-X3	Polyethylene	Orange	10	3.0	1.88	47.8	2.17	55.1	-40°F to 122°F (-40°C to 50°C)	1
CLT188F-X4	Polyethylene	Yellow	10	3.0	1.88	47.8	2.17	55.1	-40°F to 122°F (-40°C to 50°C)	1
CLT188F-X20	Polyethylene	Black	10	3.0	1.88	47.8	2.17	55.1	-40°F to 122°F (-40°C to 50°C)	1

*Reel packaging may contain splices. Contact PANDUIT Customer Service for further information.

Table continues on page C3.12

- A. System Overview
- B1. Cable Ties
- B2. Cable Accessories
- B3. Stainless Steel Ties
- C1. Wiring Duct
- C2. Surface Raceway
- C3. Abrasion Protection
- C4. Cable Management
- D1. Terminals
- D2. Power Connectors
- D3. Grounding Connectors
- E1. Labeling Systems
- E2. Labels
- E3. Pre-Printed & Write-On Markers
- E4. Permanent Identification
- E5. Lockout/Tagout & Safety Solutions
- F. Index

A. System Overview

Corrugated Loom Tubing – Slit (continued)

B1. Cable Ties

Part Number	Material	Color	Length per Reel		Inside Diameter		Outside Diameter		Temperature Range	Std. Pkg. Qty.*
			Ft.	m	In.	mm	In.	mm		

Solid Wall

B2. Cable Accessories

B3. Stainless Steel Ties

C1. Wiring Duct

C2. Surface Raceway

C3. Abrasion Protection

C4. Cable Management

D1. Terminals

D2. Power Connectors

D3. Grounding Connectors

E1. Labeling Systems

E2. Labels

E3. Pre-Printed & Write-On Markers

E4. Permanent Identification

E5. Lockout/Tagout & Safety Solutions

F. Index

CLTS25F-C3	Polyethylene	Orange	100	30.5	.28	7.0	.39	9.9	-40°F to 122°F (-40°C to 50°C)	1
CLTS25F-C	Polyethylene	Black	100	30.5	.28	7.0	.39	9.9	-40°F to 122°F (-40°C to 50°C)	1
CLTS38F-C3	Polyethylene	Orange	100	30.5	.42	10.5	.56	14.1	-40°F to 122°F (-40°C to 50°C)	1
CLTS38F-C	Polyethylene	Black	100	30.5	.42	10.5	.56	14.1	-40°F to 122°F (-40°C to 50°C)	1
CLTS50F-C3	Polyethylene	Orange	100	30.5	.51	12.8	.67	17.0	-40°F to 122°F (-40°C to 50°C)	1
CLTS50F-C	Polyethylene	Black	100	30.5	.51	12.8	.67	17.0	-40°F to 122°F (-40°C to 50°C)	1
CLTS75F-C3	Polyethylene	Orange	100	30.5	.76	19.3	.94	23.8	-40°F to 122°F (-40°C to 50°C)	1
CLTS75F-C	Polyethylene	Black	100	30.5	.76	19.3	.94	23.8	-40°F to 122°F (-40°C to 50°C)	1
CLTS100F-C3	Polyethylene	Orange	100	30.5	.92	23.2	1.09	27.7	-40°F to 122°F (-40°C to 50°C)	1
CLTS100F-C	Polyethylene	Black	100	30.5	.92	23.2	1.09	27.7	-40°F to 122°F (-40°C to 50°C)	1
CLTS125F-L3	Polyethylene	Orange	50	15.2	1.29	32.8	1.50	38.1	-40°F to 122°F (-40°C to 50°C)	1
CLTS125F-L	Polyethylene	Black	50	15.2	1.29	32.8	1.50	38.1	-40°F to 122°F (-40°C to 50°C)	1
CLTS150F-D3	Polyethylene	Orange	500	152.4	1.48	37.6	1.73	43.9	-40°F to 122°F (-40°C to 50°C)	1
Nylon Slotted										
CLT25N-C630	Heat Stabilized Nylon 6.6	Black	100	30.5	.27	6.7	.39	9.9	-40°F to 230°F (-40°C to 110°C)	1
CLT35N-C630	Heat Stabilized Nylon 6.6	Black	100	30.5	.35	8.9	.50	12.7	-40°F to 230°F (-40°C to 110°C)	1
CLT38N-C630	Heat Stabilized Nylon 6.6	Black	100	30.5	.41	10.5	.56	14.2	-40°F to 230°F (-40°C to 110°C)	1
CLT50N-C630	Heat Stabilized Nylon 6.6	Black	100	30.5	.51	12.8	.67	17.0	-40°F to 230°F (-40°C to 110°C)	1
CLT75N-C630	Heat Stabilized Nylon 6.6	Black	100	30.5	.76	19.3	.94	23.8	-40°F to 230°F (-40°C to 110°C)	1
CLT100N-C630	Heat Stabilized Nylon 6.6	Black	100	30.5	.92	23.2	1.09	27.7	-40°F to 230°F (-40°C to 110°C)	1
CLT125N-L630	Heat Stabilized Nylon 6.6	Black	50	15.2	1.29	32.8	1.50	38.1	-40°F to 230°F (-40°C to 110°C)	1
CLT150N-D630	Heat Stabilized Nylon 6.6	Black	500	152.4	1.55	39.1	1.86	47.2	-40°F to 230°F (-40°C to 110°C)	1
CLT188N-6C630	Heat Stabilized Nylon 6.6	Black	600	183.0	1.88	47.8	2.17	55.1	-40°F to 230°F (-40°C to 110°C)	1
Nylon Solid										
CLTS25N-C	Heat Stabilized Nylon 6.6	Black	100	30.5	.28	7.0	.39	9.9	-40°F to 230°F (-40°C to 110°C)	1
CLTS35N-C	Heat Stabilized Nylon 6.6	Black	100	30.5	.35	8.9	.50	12.7	-40°F to 230°F (-40°C to 110°C)	1
CLTS38N-C	Heat Stabilized Nylon 6.6	Black	100	30.5	.42	10.5	.56	14.1	-40°F to 230°F (-40°C to 110°C)	1
CLTS50N-C	Heat Stabilized Nylon 6.6	Black	100	30.5	.51	12.8	.67	17.0	-40°F to 230°F (-40°C to 110°C)	1
CLTS75N-C	Heat Stabilized Nylon 6.6	Black	100	30.5	.76	19.3	.94	23.8	-40°F to 230°F (-40°C to 110°C)	1
CLTS100N-C	Heat Stabilized Nylon 6.6	Black	100	30.5	.92	23.4	1.09	27.7	-40°F to 230°F (-40°C to 110°C)	1

*Reel packaging may contain splices. Contact PANDUIT Customer Service for further information.

Corrugated Loom Tubing Fittings

- Provide a secure way to join CLT at junctions and breakouts while improving the appearance of wire harnesses
- Color: Black
- Material: Polyethylene



Part Number	Branch Diameter		Trunk Diameter		Std. Pkg. Qty.	Std. Ctn. Qty.
	In.	mm	In.	mm		
CF382538F-Q	.38	9.5	.25	6.4	25	100
CF502550F-Q	.50	12.7	.25	6.4	25	100
CF503850F-Q	.50	12.7	.38	9.5	25	100
CF752575F-Q	.75	19.0	.25	6.4	25	100
CF753875F-Q	.75	19.0	.38	9.5	25	100

Part Number System for Braided Expandable Sleeving

SE	25	PFR	-	M	R	0
Type	Nominal I.D. Size	Material		Package Size	R = Reel	Color Suffix
SE = Sleeving Expandable	12 = 1/8" (3.2mm)	P = Polyethylene Terephthalate (PET)		L = 50' (15.2M)		0 = Black
	25 = 1/4" (6.4mm)	PFR = Polyethylene Terephthalate (PET) Flame Retardant		C = 100' (30.5M)		8 = Gray
	38 = 3/8" (9.5mm)	PSC = Fray Resistant Polyethylene Terephthalate (PET)		T = 200' (61.0M)		10 = White
	50 = 1/2" (12.7mm)			D = 500' (152.4M)		
	75 = 3/4" (19.1mm)			M = 1000' (304.8M)		
	125 = 1 1/4" (31.8mm)					
	150 = 1 1/2" (38.1mm)					
	175 = 1 3/4" (44.5mm)					



Braided Expandable Sleeving – Polyethylene Terephthalate (PET)

- Provides continuous abrasion protection for wires, cables, hoses and tubing
- Highly flexible open weave will not trap heat or humidity



Part Number	Color	Nominal I.D.		Nominal Diameter Range		Length per Reel		Std. Pkg. Qty.	Std. Ctn. Qty.
		In.	mm	In.	mm	Ft.	m		
SE12P-TR0	Black	.12	3.2	.094 to .250	2.4 to 6.4	200	61.0	1	4
SE12P-TR8	Gray	.12	3.2	.094 to .250	2.4 to 6.4	200	61.0	1	4
SE12P-MR0	Black	.12	3.2	.094 to .250	2.4 to 6.4	1000	304.8	1	2
SE12P-MR8	Gray	.12	3.2	.094 to .250	2.4 to 6.4	1000	304.8	1	2
SE12P-MR10	White	.12	3.2	.094 to .250	2.4 to 6.4	1000	304.8	1	2
SE25P-TR0	Black	.25	6.4	.125 to .375	3.2 to 9.5	200	61.0	1	4
SE25P-TR8	Gray	.25	6.4	.125 to .375	3.2 to 9.5	200	61.0	1	4
SE25P-MR0	Black	.25	6.4	.125 to .375	3.2 to 9.5	1000	304.8	1	2
SE25P-MR8	Gray	.25	6.4	.125 to .375	3.2 to 9.5	1000	304.8	1	2
SE25P-MR10	White	.25	6.4	.125 to .375	3.2 to 9.5	1000	304.8	1	2
SE38P-TR0	Black	.38	9.5	.188 to .625	4.7 to 15.9	200	61.0	1	4
SE38P-TR8	Gray	.37	9.5	.188 to .625	4.7 to 15.9	200	61.0	1	4
SE38P-MR0	Black	.37	9.5	.188 to .625	4.7 to 15.9	1000	304.8	1	2
SE38P-MR8	Gray	.37	9.5	.188 to .625	4.7 to 15.9	1000	304.8	1	2
SE38P-MR10	White	.37	9.5	.188 to .625	4.7 to 15.9	1000	304.8	1	2
SE50P-CR0	Black	.50	12.7	.250 to .750	6.4 to 19.1	100	30.5	1	4
SE50P-CR8	Gray	.50	12.7	.250 to .750	6.4 to 19.1	100	30.5	1	4
SE50P-DR0	Black	.50	12.7	.250 to .750	6.4 to 19.1	500	152.4	1	2
SE50P-DR8	Gray	.50	12.7	.250 to .750	6.4 to 19.1	500	152.4	1	2
SE50P-DR10	White	.50	12.7	.250 to .750	6.4 to 19.1	500	150.4	1	2
SE75P-CR0	Black	.75	19.1	.500 to 1.25	12.7 to 31.8	100	30.5	1	4
SE75P-CR8	Gray	.75	19.1	.500 to 1.25	12.7 to 31.8	100	30.5	1	4
SE75P-DR0	Black	.75	19.1	.500 to 1.25	12.7 to 31.8	500	152.4	1	2
SE75P-DR8	Gray	.75	19.1	.500 to 1.25	12.7 to 31.8	500	152.4	1	2
SE75P-DR10	White	.75	19.1	.500 to 1.25	12.7 to 31.8	500	152.4	1	2
SE125P-LR0	Black	1.25	31.8	.750 to 1.50	19.1 to 38.1	50	15.2	1	4
SE125P-LR8	Gray	1.25	31.8	.750 to 1.50	19.1 to 38.1	50	15.2	1	4
SE125P-TR0	Black	1.25	31.8	.750 to 1.50	19.1 to 38.1	200	61.0	1	2
SE125P-TR8	Gray	1.25	31.8	.750 to 1.50	19.1 to 38.1	200	61.0	1	2
SE125P-TR10	White	1.25	31.8	.750 to 1.50	19.1 to 38.1	200	61.0	1	2
SE150P-LR0	Black	1.50	38.1	1.00 to 2.25	25.4 to 57.2	50	15.2	1	4
SE150P-LR8	Gray	1.50	38.1	1.00 to 2.25	25.4 to 57.2	50	15.2	1	4
SE150P-TR0	Black	1.50	38.1	1.00 to 2.25	25.4 to 57.2	200	61.0	1	2
SE150P-TR8	Gray	1.50	38.1	1.00 to 2.25	25.4 to 57.2	200	61.0	1	2
SE150P-TR10	White	1.50	38.1	1.00 to 2.25	25.4 to 57.2	200	61.0	1	2
SE175P-TR0	Black	1.75	44.5	1.25 to 2.75	31.8 to 69.8	200	61.0	1	2

Reel packaging may contain splices. Contact PANDUIT Customer Service for further information.

A. System Overview



Braided Expandable Sleeving – Flame Retardant Polyethylene Terephthalate

B1. Cable Ties

- Provides continuous abrasion protection for wires, cables, hoses and tubing
- Highly flexible open weave will not trap heat or humidity
- Rated for use up to 257°F (125°C)
- Allows for use with irregular shapes
- Flammability: Meets UL 224 VW-1

B2. Cable Accessories



B3. Stainless Steel Ties

C1. Wiring Duct

C2. Surface Raceway

C3. Abrasion Protection

C4. Cable Management

D1. Terminals

D2. Power Connectors

D3. Grounding Connectors

E1. Labeling Systems

E2. Labels

E3. Pre-Printed & Write-On Markers

E4. Permanent Identification

E5. Lockout/Tagout & Safety Solutions

F. Index

Part Number	Color	Nominal I.D.		Nominal Diameter Range		Length per reel		Std. Pkg. Qty.	Std. Ctn. Qty.
		In.	mm	In.	mm	Ft.	m		
SE12PFR-TR0	Black	.12	3.2	.094 to .250	2.4 to 6.4	200	61.0	1	4
SE12PFR-MR0	Black	.12	3.2	.094 to .250	2.4 to 6.4	1000	304.8	1	2
SE12PFR-TR8	Gray	.12	3.2	.094 to .250	2.4 to 6.4	200	61.0	1	4
SE12PFR-MR8	Gray	.12	3.2	.094 to .250	2.4 to 6.4	1000	304.8	1	2
SE12PFR-MR10	White	.12	3.2	.094 to .250	2.4 to 6.4	1000	304.8	1	2
SE25PFR-TR0	Black	.25	6.4	.125 to .375	3.2 to 9.5	200	61.0	1	4
SE25PFR-MR0	Black	.25	6.4	.125 to .375	3.2 to 9.5	1000	304.8	1	2
SE25PFR-TR8	Gray	.25	6.4	.125 to .375	3.2 to 9.5	200	61.0	1	4
SE25PFR-MR8	Gray	.25	6.4	.125 to .375	3.2 to 9.5	1000	304.8	1	2
SE25PFR-MR10	White	.25	6.4	.125 to .375	3.2 to 9.5	1000	304.8	1	2
SE38PFR-MR8	Gray	.37	9.5	.188 to .625	4.7 to 15.9	1000	304.8	1	2
SE38PFR-MR10	White	.37	9.5	.188 to .625	4.7 to 15.9	1000	304.8	1	2
SE50PFR-CR0	Black	.50	12.7	.250 to .750	6.4 to 19.1	100	30.5	1	4
SE50PFR-CR8	Gray	.50	12.7	.250 to .750	6.4 to 19.1	100	30.5	1	4
SE50PFR-DR0	Black	.50	12.7	.250 to .750	6.4 to 19.1	500	152.4	1	2
SE50PFR-DR8	Gray	.50	12.7	.250 to .750	6.4 to 19.1	500	152.4	1	2
SE50PFR-DR10	White	.50	12.7	.250 to .750	6.4 to 19.1	500	152.4	1	2
SE75PFR-CR0	Black	.75	19.1	.500 to 1.25	12.7 to 31.8	100	30.5	1	4
SE75PFR-CR8	Gray	.75	19.1	.500 to 1.25	12.7 to 31.8	100	30.5	1	4
SE75PFR-DR0	Black	.75	19.1	.500 to 1.25	12.7 to 31.8	500	152.4	1	2
SE75PFR-DR8	Gray	.75	19.1	.500 to 1.25	12.7 to 31.8	500	152.4	1	2
SE75PFR-DR10	White	.75	19.1	.500 to 1.25	12.7 to 31.8	500	152.4	1	2
SE125PFR-LR0	Black	1.25	31.8	.750 to 1.50	19.1 to 38.1	50	15.2	1	4
SE125PFR-LR8	Gray	1.25	31.8	.750 to 1.50	19.1 to 38.1	50	15.2	1	4
SE125PFR-TR0	Black	1.25	31.8	.750 to 1.50	19.1 to 38.1	200	61.0	1	2
SE125PFR-TR8	Gray	1.25	31.8	.750 to 1.50	19.1 to 38.1	200	61.0	1	2
SE125PFR-TR10	White	1.25	31.8	.750 to 1.50	19.1 to 38.1	200	61.0	1	2
SE150PFR-LR0	Black	1.50	38.1	1.00 to 2.25	25.4 to 57.2	500	152.4	1	4
SE150PFR-LR8	Gray	1.50	38.1	1.00 to 2.25	25.4 to 57.2	50	5.2	1	4
SE150PFR-TR0	Black	1.50	38.1	1.00 to 2.25	25.4 to 57.2	200	61.0	1	2
SE150PFR-TR8	Gray	1.50	38.1	1.00 to 2.25	25.4 to 57.2	200	61.0	1	2
SE150PFR-TR10	White	1.50	38.1	1.00 to 2.25	25.4 to 57.2	200	61.0	1	2
SE175PFR-TR0	Black	1.75	44.5	1.25 to 2.75	31.8 to 69.8	200	61.0	1	2

Reel packaging may contain splices. Contact PANDUIT Customer Service for further information.

Tooling Head

- Sleeving cutter/end sealer blade – used with popular soldering guns to cut and seal sleeving



Part Number	Description	Std. Pkg. Qty.
HKBS	For dual straight shank soldering guns with .500" spacing typical guns: WELLER Straight Shank Model 8200; WEN Model 199 or 100 (Replace tip holding screws with (2) screws included).	1

Fray Resistant Braided Expandable Sleeving

- Fray-resistant design resists fraying when cut with scissors
- Provides continuous abrasion protection resistance for wires, cables, and tubing
- For indoor use only
- Material: Polyethylene Terephthalate



Part Number	Color	Nominal I.D.		Nominal Diameter Range		Length per Reel‡		Std. Pkg. Qty.	Std. Ctn. Qty.
		In.	mm	In.	mm	Ft.	m		
SE12PSC-TR0	Black	.13	3.1	.13 to .25	3.2 to 6.4	200	61.0	1	4
SE25PSC-TR0	Black	.25	6.4	.16 to .44	4.0 to 11.1	200	61.0	1	4
SE38PSC-TR0	Black	.38	9.5	.19 to .63	4.8 to 15.9	200	61.0	1	4
SE50PSC-CR0	Black	.50	12.7	.25 to .75	6.4 to 19.0	100	30.5	1	4
SE75PSC-CR0	Black	.75	19.1	.63 to 1.0	15.9 to 25.4	100	30.5	1	4
SE125PSC-LR0	Black	1.25	31.8	1.0 to 1.5	25.4 to 38.1	50	15.2	1	4
SE150PSC-LR0	Black	1.50	38.1	1.3 to 2.0	31.8 to 50.8	50	15.2	1	4

‡Reel packaging may contain splices. Contact PANDUIT Customer Service for further information.

A.
System
Overview

B1.
Cable Ties

B2.
Cable
Accessories

B3.
Stainless
Steel Ties

C1.
Wiring
Duct

C2.
Surface
Raceway

C3.
Abrasion
Protection

C4.
Cable
Management

D1.
Terminals

D2.
Power
Connectors

D3.
Grounding
Connectors

E1.
Labeling
Systems

E2.
Labels

E3.
Pre-Printed
& Write-On
Markers

E4.
Permanent
Identification

E5.
Lockout/
Tagout/
& Safety
Solutions

F.
Index

A. System Overview

B1. Cable Ties

B2. Cable Accessories

B3. Stainless Steel Ties

C1. Wiring Duct

C2. Surface Raceway

C3. Abrasion Protection

C4. Cable Management

D1. Terminals

D2. Power Connectors

D3. Grounding Connectors

E1. Labeling Systems

E2. Labels

E3. Pre-Printed & Write-On Markers

E4. Permanent Identification

E5. Lockout/Tagout & Safety Solutions

F. Index

Part Number System for Non-Shrink PVC Tubing

TV105	-	12	M
Type		Nominal Size	Package Quantity
TV105 = PVC Tubing		1 = 1 AWG	C = 100' (30.5m)
		12 = 12 AWG	TL = 250' (76.2m)
		6 = 6 AWG	D = 500' (152.4m)
		.38 = 3/8"	M = 1000' (304.8m)
		.50 = 1/2"	
		.75 = 3/4"	
		1.0 = 1"	

Non-Shrink PVC Tubing

- Provides insulation and protection for lead wires, wire harness assemblies, soldered joints, and components in electrical and electronic equipment
- All purpose flexible and non-shrinkable
- Resistant to heat and moisture
- UL Recognized, CSA Certified
- Flammability: Meets UL 224 VW-1
- Voltage rating: 300 V and 600 V
- ASTM D-922 Grade CFR
- MIL-I-631 Type F, Form U, Grade C- Class 1 Category 1
- Material: Polyvinyl chloride (PVC)



Part Number	Color	Nominal Size	Length per Reel		Max. Inside Diameter		Wall Thickness		Max. Voltage Rating	Std. Pkg. Qty.	Std. Ctn. Qty.
			Ft.	m	In.	mm	In.	mm			
TV105-12MY	Clear	12 AWG	1000	304.8	.089	2.26	.016	.41	300 V	1	2
TV105-12M20Y	Black	12 AWG	1000	304.8	.089	2.26	.016	.41	300 V	1	2
TV105-6MY	Clear	6 AWG	1000	304.8	.178	4.52	.020	.51	300 V	1	2
TV105-6M20Y	Black	6 AWG	1000	304.8	.178	4.52	.020	.51	300 V	1	2
TV105-3MY	Clear	3 AWG	1000	304.8	.249	6.32	.020	.51	300 V	1	2
TV105-3M20Y	Black	3 AWG	1000	4.8	.249	6.32	.020	.51	300 V	1	2
TV105-1MY	Clear	1 AWG	1000	304.8	.311	7.89	.020	.51	300 V	1	0
TV105-1M20Y	Black	1 AWG	1000	304.8	.311	7.89	.020	.51	300 V	1	0
TV105-.38DY	Clear	3/8	500	152.4	.399	10.13	.025	.64	600 V	1	0
TV105-.38D20Y	Black	3/8	500	152.4	.399	10.13	.025	.64	600 V	1	0
TV105-.50DY	Clear	1/2	500	152.4	.524	13.30	.025	.64	600 V	1	0
TV105-.50D20Y	Black	1/2	500	152.4	.524	13.30	.025	.64	600 V	1	0
TV105-.75TLY	Clear	3/4	250	76.2	.786	19.96	.035	.89	600 V	1	0
TV105-.75TL20Y	Black	3/4	250	76.2	.786	19.96	.035	.89	600 V	1	0
TV105-1.0CY	Clear	1	100	30.5	1.036	26.31	.035	.89	600 V	1	2
TV105-1.0C20Y	Black	1	100	30.5	1.036	26.31	.035	.89	600 V	1	2

Duct Seal – Sealing Compounds

- Seals irregular openings from air, dust, or water
- Non-hardening sealant that adheres to metal, masonry, wood or plastic
- Provides vibration dampening
- Meets the requirements of UL 514A (paragraph 29.5.1 to 29.5.3) – electrical outlet box cover water seal
- Safe and easy to use, non-corrosive, non-toxic, no asbestos, will not stain or harm hands, and no unpleasant odor.
- Dielectric strength: 200 V/Mil, Min .030 inches thick



Part Number	Description	Std. Pkg. Qty.
DS1	Duct seal (sealing compound) 1 lb. package	1
DS5	Duct seal (sealing compound) 5 lb. package	1

Flammability Tests and Classification

Abrasion Protection Products Flammability Tests and Classifications



- A number of test procedures have been developed which can be used for the evaluation and comparison of various materials to support combustion
- Review the following classifications to find which category is designed to suit your abrasion and protection applications

UL 94 Vertical Burning Test

Test samples of material, with dimension $125 \pm 5\text{mm}$ by $13.0 \pm 5\text{mm}$ and provided in the minimum and maximum thickness of the intended end use product, are tested in an unconditioned (as manufactured) state and in a conditioned state (7 days at 168F° , 75°C). The test requires the placement of a precisely controlled flame under a vertically supported specimen for a 10 second period. The flame is removed and the duration of flaming is recorded. If the flame extinguishes, the specimen is immediately subjected to a second 10 second ignition period. Duration of flaming is again recorded. A piece of 100% cotton is placed under the specimen. Also observed and documented is if the sample drips flaming particles that ignite the cotton indicator below.

Materials Classification

Criteria Conditions	V-0	V-1	V-2
Afterflame time for each individual specimen t_1 or t_2	$\leq 10\text{s}$	$\leq 30\text{s}$	$\leq 30\text{s}$
Total afterflame time for any condition set (t_1 plus t_2 for the 5 specimens)	$\leq 50\text{s}$	$\leq 250\text{s}$	$\leq 250\text{s}$
Afterflame plus afterglow time for each individual specimen after the second flame application ($t_2 + t_3$)	$\leq 30\text{s}$	$\leq 60\text{s}$	$\leq 60\text{s}$
Afterflame or afterglow of any specimen up to the holding clamp	No	No	No
Cotton indicator ignited by flaming particles or drops	No	No	Yes

t_1	After flame time after first flame application
t_2	After flame time after flame application
t_3	After glow time after second flame application

MATERIALS CLASSIFIED UL 94 HB

- Specimens shall have a maximum burn rate of <1.5 in./min over 3 inches of thickness of .120 inches to .5 inches
- Specimens shall have a maximum burn rate of <30 in./min over 3 inches for a thickness less than .120 inches

UL 224 VERTICAL WIRE FLAME TEST

Samples of fully recovered tubing are placed over a length of fine spring steel music wire. The test requires the precise placement of a controlled flame that contacts the heat shrink tubing. The flame is applied in five 15 second intervals with a time period between applications. If the flame extinguishes immediately after the first flame removal, subsequent flame applications are made to the tubing. Duration of specimen flaming is noted. A piece of surgical cotton is placed under the specimen. If a flaming or glowing piece of tubing drips and ignites the cotton, this is also noted.

MATERIALS CLASSIFIED AS VW-1 SHALL:

- Not flame or glow longer than 60 seconds following any of the five applications of the flame
- Not ignite or damage more than 25% of kraft paper flag that is placed around the top of the tubing
- Not have any specimens which drip flaming particles and ignite the surgical cotton located 9 1/2 inches below the test specimen

A.
System
Overview

B1.
Cable
Ties

B2.
Cable
Accessories

B3.
Stainless
Steel Ties

C1.
Wiring
Duct

C2.
Surface
Raceway

C3.
Abrasion
Protection

C4.
Cable
Management

D1.
Terminals

D2.
Power
Connectors

D3.
Grounding
Connectors

E1.
Labeling
Systems

E2.
Labels

E3.
Pre-Printed
& Write-On
Markers

E4.
Permanent
Identification

E5.
Lockout/
Tagout
& Safety
Solutions

F.
Index

A. System Overview
B1. Cable Ties
B2. Cable Accessories
B3. Stainless Steel Ties
C1. Wiring Duct
C2. Surface Raceway
C3. Abrasion Protection
C4. Cable Management
D1. Terminals
D2. Power Connectors
D3. Grounding Connectors
E1. Labeling Systems
E2. Labels
E3. Pre-Printed & Write-On Markers
E4. Permanent Identification
E5. Lockout/Tagout & Safety Solutions
F. Index

Abrasion Protection Materials Technical Data

		Ratings and Approvals			Physical Properties				Chemical Resistance			
		UL Temperature Index	Flammability (UL 94)	Melting Temperature	Abrasion Resistance (Lower number is better)	Specific Gravity (D792)	Minimum Tensile @23°C (psi)	Water Absorption (Max. 24 hrs.)	Organic Solvents	Alkalies	Acids	Petro-Chemicals
SPIRAL WRAP	Natural Polyethylene Lowest cost material for indoor use up to 122°C. Natural is available in all sizes.	-40°F (-40°C) to 122°F (50°C)	HB	239°F (115°C)	22 mg	.91 – .93	1400 (D368)	.01%	Resistant below 140°F (60°C) except to chlorinated solvents	Resistant	Resistant except to oxidizing acids	Some Discoloration
	Weather Resistant Polyethylene This material has the same properties as natural polyethylene, and also has additives which allow it to resist the effects of ultraviolet light and acid rain in an outdoor environment. This product is available only.	-40°F (-40°C) to 122°F (50°C)	HB	239°F (115°C)	20 mg	.93 – 1.09	2000 (D368)	.03%	Resistant below 140°F (60°C) except to chlorinated solvents	Resistant	Resistant except to oxidizing acids	No Discoloration
	Fire Resistant Polyethylene UL 94-V2 Rating This material is self-extinguishing and passes the UL 94 flame retardant test with V2 rating.	-40°F (-40°C) to 194°F (90°C)	V-2	239°F (115°C)	27 mg	1.00 – 1.30	1400 (D368)	.02%	Resistant below 140°F (60°C) except to chlorinated solvents	Resistant	Resistant except to oxidizing acids	Some Discoloration
	Flame Retardant Polyethylene UL 94-V0 Rating. This material is self extinguishing and passes the UL 94 flame retardant test with a V0 rating.	-4°F (-20°C) to 212°F (100°C)	V-0	270°F (132°C)	22 mg	1.23 – 1.37	1500 (D368)	.02%	Resistant except to halogenated hydrocarbons	Resistant	Resistant	Resistant Some Discoloration
	Nylon 6.6 Nylon is strong, durable, self-extinguishing material for indoor use up to 149°F. It offers a combination of lightweight, wide temperature range, and high abrasion resistance. This material is suitable for applications where heavy vibration or stress exists on the wiring or tubing.	-40°F (-40°C) to 149°F (65°C)	V-2	505°F (263°C)	7 mg	1.13 – 1.15	12,400 (D368)	1.2%	Resistant except to halogenated hydrocarbons	Resistant	Not recommended	Resistant No Discoloration
	Weather Resistant Nylon This material has the same properties as natural Nylon and also has additives which allow it to resist the effects of ultraviolet light in an outdoor environment. This product is available in black only.	-40°F (-40°C) to 149°F (65°C)	V-2	505°F (263°C)	7 mg	1.13 – 1.15	12,400 (D368)	1.2%	Resistant except to halogenated hydrocarbons	Resistant	Not recommended	Resistant No Discoloration
	TEFLON‡ This material is a non-flammable, fluorocarbon resin material. Suitable for use in any application (including nuclear containment). It is rated up to 356°F. Color: Opaque to Translucent	-40°F (-40°C) to 500°F (260°C)	V-0	648°F (342°C)	7 mg	2.13 – 2.22	3000 (D876)	.01%	Resistant	Resistant	Resistant	Resistant No Discoloration
	Natural Polyethylene Lowest cost material for indoor use up to 50°C. Natural is available in all sizes.	-40°C to 50°C	HB	115°C	22 mg	.91 – .93	1400 (D638)	.01%	Resistant below 60°C except to chlorinated solvents	Resistant	Resistant except to oxidizing acids	Some Discoloration
	Flame Retardant Polyethylene UL 94-V0 Rating. This material is self extinguishing and passes the UL 94 flame retardant test with a V0 rating.	-4°F (-20°C) to 212°F (100°C)	V-0	132°C	22 mg	1.15	1500 (D876)	.02%	Resistant except to halogenated hydrocarbons	Resistant	Resistant	Resistant Some Discoloration
	SLEEVING	Polyethylene Terephthalate (PET) This material is a thermoplastic polyester material designed for indoor applications. It is rated for use up to 257°F and will tolerate short-term exposure up to 446°F. Colors: Black, White and Gray	-94°F (-70°C) to 257°F (125°C)	HB	500°F (260°C)	—	1.39	100,000 (D876)	.08%	Resistant to some solvents	Resistant to most weak bases	Resistant
Flame Ret. Polyethylene Terephthalate (PET) This material is a self-extinguishing thermoplastic polyester that can be used indoors. It is also rated for use up to 257°F and will tolerate short term exposure up to 446°F. It is provided with tracers to identify the flame retardant material.		-94°F (-70°C) to 257°F (125°C)	UL 1441 VW-1	469°F	—	1.39	39,295 (D876)	.08%	Resistant to some solvents	Resistant to most weak bases	Resistant	Resistant Some Discoloration

Note: Typical operating temperature ranges are extended based on end use application and specific environment tests.
 ‡TEFLON or equivalent fluorocarbon PTFE is used. TEFLON is a registered trademark of E.I. du Pont de Nemours and Company.

Abrasion Protection Materials Technical Data (continued)

		Ratings and Approvals			Physical Properties				Chemical Resistance			
		UL Temperature Index	Flammability (UL 94)	Melting Temperature	Abrasion Resistance (Lower number is better)	Specific Gravity (D792)	Minimum Tensile @23°C (psi)	Water Absorption (Max. 24 hrs.)	Organic Solvents	Alkalies	Acids	Petro-Chemicals
CLT	Black Polyethylene Lowest cost material is for use up to 122°F. Other colors may be available.	-40°F (-40°C) to 122°F (50°C)	HB	—	—	.926 – .940	1500 (D638)	—	Resistant except to halogenated hydrocarbons	Resistant	Resistant	Resistant No Discoloration
	Nylon 6 Nylon is a strong, impact modified, heat stabilized, durable high abrasion resistant material.	-40°F (-40°C) to 230°F (110°C)	HB	410°F (211°C)	—	1.06 – 1.16	8000 (D638)	—	Resistant except to halogenated hydrocarbons	Resistant	Not recommended	Resistant No Discoloration
PVC	PVC Non-Shrink Tubing This material provides insulation and protection for continuous use at temperature -4°F (-20°C) to 221°F(105°C)	-4°F (-20°C) to 221°F (105°C)	UL 224 VW-1	—	—	1.35	2500 (D876)	—	Resistant except to aromatic hydrocarbons, ketones and esters	Resistant	Resistant	Resistant No Discoloration
CLT FITTINGS	Black Polyethylene Lowest cost material is for use up to 122°F. Other colors may be available.	—	UL 94 HB	—	—	1.04	3,900 (D638)	.02-.03%	Resistant except to halogenated hydrocarbons	Resistant	Resistant except to oxidizing acids	Resistant Some Discoloration
GROMMET EDGING	Natural Polyethylene Lowest cost material for indoor use up to 122° F. Natural is available in all sizes.	-40°F (-40°C) to 122°F (50°C)	HB	239°F (115°C)	22 mg	.91 – 1.09	1400 (D638)	—	Resistant below 140°F (60°C) except to chlorinated solvents	Resistant	Resistant except to oxidizing acids	Some Discoloration
	Weather Resistant Polyethylene This material has the same properties as natural polyethylene, and also has additives which allow it to resist the effects of ultraviolet light and acid rain in an outdoor environment. This product is available only.	-40°F (-40°C) to 122°F (50°C)	HB	239°F (115°C)	20 mg	.93 – 1.09	2000 (D638)	.03%	Resistant below 140°F (60°C) except to chlorinated solvents	Resistant	Resistant except to oxidizing acids	No Discoloration
	Flame Retardant Polyethylene UL 94-V0 Rating This material is self-extinguishing and passes the UL 94 flame retardant test with a V0 rating.	-40°F (-40°C) to 194°F (90°C)	V-0	270°F (132°C)	22 mg	1.23 – 1.37	1200	.02%	Resistant below 194°F (90°C) except to chlorinated solvents	Resistant	Resistant except to oxidizing acids	Some Discoloration
	Nylon Nylon is strong, durable, self-extinguishing material for indoor use up to 149°F. It offers a combination of lightweight, wide temperature range, and high abrasion resistance. This material is suitable for applications where heavy vibration or stress exists on the wiring or tubing.	-40°F (-40°C) to 149°F (65°C)	V-2	491°F (255°C)	7 mg	1.03 – 1.15	12,400 (D638)	1.5%	Resistant except to phenols and formic acid	Resistant	Resistant to most weak acids	No Discoloration

Note: Typical operating temperature ranges are extended based on end use application and specific environment tests.

A. System Overview

B1. Cable Ties

B2. Cable Accessories

B3. Stainless Steel Ties

C1. Wiring Duct

C2. Surface Raceway

C3. Abrasion Protection

C4. Cable Management

D1. Terminals

D2. Power Connectors

D3. Grounding Connectors

E1. Labeling Systems

E2. Labels

E3. Pre-Printed & Write-On Markers

E4. Permanent Identification

E5. Lockout/Tagout & Safety Solutions

F. Index

A. System Overview

PANDUIT Heat Shrink Tubing Heat Shrink Tubing Quick Selection Guide

B1. Cable Ties

Quick reference for PANDUIT Heat Shrink for specific location applications

B2. Cable Accessories



B3. Stainless Steel Ties

C1. Wiring Duct

C2. Surface Raceway

C3. Abrasion Protection

C4. Cable Management

CHARACTERISTICS

	HSTT	HSTTV	HSTTN	HSTTK	HSTTT	HSTTP	HSTTPN	HSTTVA	HSTTRA	HSTTA	HST	HSEC	HSECFR
UL Listed											X		
UL Recognized	X‡	X		X		X	X						
CSA Certified	X‡3	X3				X3	X				X		
VW-1-Rated		X		X		X	X						
Very Flexible		X	X										
Flexible	X					X	X	X		X			
Semi-Rigid				X	X		X		X		X		
Thin Wall	X	X	X	X	X	X	X	X	X	X			
Thick Wall											X	X	X
Cross-Linked Material	X	X	X	X		X		X	X	X	X	X	X
Colors Available	X	X									X*		
Shrink Ratio	2:1	2:1	2:1	2:1	2:1	2:1	2:1	2:1	5:1	3:1	3:1	3:1	3:1
Flame Retardant	X‡	X	X	X	X	X	X	X	X	X	X		X
Adhesive Lined (Dual Wall)								X	X	X	X	X	X
Meets Military Specifications	X	X	X	X	X		X	X	X	X	X		
Below Ground Application											X		
High Temp Applications (>250°F)				X	X								
Highly Chemical Resistant			X	X	X								
Low Coefficient of Friction					X								
Custom Cut Lengths	X	X	X	X	X	X		X	X	X	X		
Standard 6" pieces	X	X						X		X			
Standard 4" lengths	X	X		X	X			X	X	X	X		
Small 25' Reels	X	X	X			X							
Large Reels	X	X	X			X	X						
IP Rating	62	62	62	62	62	62	62	66	66	66	68	68	68
Found on Page...	C3.22 – C3.25	C3.26 – C3.29	C3.31	C3.33	C3.32	C3.30	C3.31	C3.33 – C3.34	C3.35	C3.34	C3.35 – C3.36	C3.37	C3.37

*Black/Red
‡Except Clear

E2. Labels

E3. Pre-Printed & Write-On Markers

E4. Permanent Identification

E5. Lockout/Tagout & Safety Solutions

F. Index

Part Number System for Thin Wall Heat Shrink

HSTT	12	48	Q	10
Type	Expanded Diameter	Tube Length	Package Quantity	Color
HSTT = Thin Wall	05 = 3/64" (1.2mm)	3 = 3" (76.2mm)	(If Tube Length Specified)	NONE = Black
HSTTV = Thin Wall VW-1	06 = 1/16" (1.6mm)	6 = 6" (152.4mm)	1 = 1 pc.	C = Clear
HSTTN = Thin Wall Neoprene	09 = 3/32" (2.4mm)	9 = 9" (228.6mm)	2 = 2 Pcs.	2 = Red
HSTTK = Thin Wall PVDF KYNAR ▲	12 = 1/8" (3.2mm)	12 = 12" (304.8mm)	3 = 3 Pcs.	4 = Yellow
HSTTT = Thin Wall TFE TEFLON ‡	19 = 3/16" (4.8mm)	48" = (1.2m)	5 = 5 Pcs.	5 = Green
HSTTP = Thin Wall PVC	25 = 1/4" (6.4mm)	NONE = REEL	X = 10 Pcs.	6 = Blue
HSTTPN = Crystal Clear Thin Wall PVC	38 = 3/8" (9.5mm)		Q = 25 Pcs.	10 = White
HSTTV A = Flexible Adhesive Lined	50 = 1/2" (12.7mm)		LQ = 75 Pcs.	45 = Yellow/ Green
HSTTR A = Semi-Rigid Adhesive Lined	75 = 3/4" (19.0mm)		CQ = 125 Pcs.	
HSTTA = Thin Wall Adhesive Lined	100 = 1" (25.4mm)		T = 200 Pcs.	
HST = Thick Wall Adhesive Lined	150 = 1 1/2" (38.1mm)		TL = 250 Pcs.	
HSEC = Heat Shrink End Caps Adhesive Lined	200 = 2" (50.5mm)		Y = 6" Pcs.	
HSECFR = Heat Shrink End Caps Flame Retardant Adhesive Lined	300 = 3" (76.2mm)			
	400 = 4" (10.16mm)		Reels	
	0.4 = .40" (10.1mm)		(If No Tube Length Specified)	
	0.5 = .47" (11.9mm)		Q = 25' (7.6m)	
	0.8 = .80" (20.3mm)		L = 50' (15.2m)	
	1.0 = 1.0" (25.4mm)		C = 100' (30.5m)	
	1.1 = 1.1" (27.9mm)		T = 200' (61.0m)	
	1.5 = 1.5" (38.1mm)		D = 500' (152.4m)	
	2.0 = 2.0" (50.5mm)		M = 1000' (304.8m)	
	3.0 = 3.0" (76.2mm)			
	4.0 = 4.0" (101.6mm)			

For Standard Packages containing 6" (152.4mm) lengths, refer to individual pages for complete part number offering.

Note: The above information is to be used as a guide. For specific part number offerings review individual pages for verification.

▲KYNAR is a registered trademark of Atofina Chemicals, Inc.

‡TEFLON is a registered trademark of E.I. du Pont de Nemours and Company.

A.
System
Overview

B1.
Cable Ties

B2.
Cable
Accessories

B3.
Stainless
Steel Ties

C1.
Wiring
Duct

C2.
Surface
Raceway

C3.
Abrasion
Protection

C4.
Cable
Management

D1.
Terminals

D2.
Power
Connectors

D3.
Grounding
Connectors

E1.
Labeling
Systems

E2.
Labels

E3.
Pre-Printed
& Write-On
Markers

E4.
Permanent
Identification

E5.
Lockout/
Tagout
& Safety
Solutions

F.
Index

A. System Overview

HSTT Heat Shrink 4 Foot Pieces and Reels

B1. Cable Ties

- Applications include insulating, protecting, and color coding wires and cables
- Voltage: 600 V
- Shrink ratio: 2:1
- Flammability: Flame retardant EXCEPT clear
- UL Recognized, CSA Certified
- Mil Spec: AMS-DTL-23053/5 Class 1 (Colors) Class 2 (Clear)
- Temperature range: -67°F to 275°F (-55°C to 135°C)
- For dry locations
- Material: Black cross-linked Polyolefin

B2. Cable Accessories

B3. Stainless Steel Ties



C1. Wiring Duct



C2. Surface Raceway

C3. Abrasion Protection

C4. Cable Management

D1. Terminals

D2. Power Connectors

D3. Grounding Connectors

E1. Labeling Systems

E2. Labels

E3. Pre-Printed & Write-On Markers

E4. Permanent Identification

E5. Lockout/Tagout & Safety Solutions

F. Index

Part Number*	Nominal Diameter		Min. Expanded I.D.		Max. Recovered I.D.		Nominal Recovered Wall Thickness		Length		Length per Reel		Std. Pkg. Qty.	Std Ctn. Qty.
	In.	mm	In.	mm	In.	mm	In.	mm	Ft.	m	Ft.	m		
HSTT05-48-Q	.046	1.2	.046	1.2	.023	.6	.016	.4	4	1.2	—	—	25	—
HSTT05-48-TL	.046	1.2	.046	1.2	.023	.6	.016	.4	4	1.2	—	—	250	—
HSTT05-C‡	.046	1.2	.046	1.2	.023	.6	.016	.4	—	—	100	30.5	1	10
HSTT05-M‡	.046	1.2	.046	1.2	.023	.6	.016	.4	—	—	1000	304.8	1	2
HSTT06-48-Q	.063	1.6	.063	1.6	.031	.8	.017	.4	4	1.2	—	—	25	—
HSTT06-48-TL	.063	1.6	.063	1.6	.031	.8	.017	.4	4	1.2	—	—	250	—
HSTT06-C‡	.063	1.6	.063	1.6	.031	.8	.017	.4	—	—	100	30.5	1	10
HSTT06-M‡	.063	1.6	.063	1.6	.031	.8	.017	.4	—	—	1000	304.8	1	2
HSTT09-48-Q	.093	2.4	.093	2.4	.046	1.2	.020	.5	4	1.2	—	—	25	—
HSTT09-48-TL	.093	2.4	.093	2.4	.046	1.2	.020	.5	4	1.2	—	—	250	—
HSTT09-C‡	.093	2.4	.093	2.4	.046	1.2	.020	.5	—	—	100	30.5	1	10
HSTT09-M‡	.093	2.4	.093	2.4	.046	1.2	.020	.5	—	—	1000	304.8	1	2
HSTT12-48-Q	.125	3.2	.125	3.2	.062	1.6	.020	.5	4	1.2	—	—	25	—
HSTT12-48-TL	.125	3.2	.125	3.2	.062	1.6	.020	.5	4	1.2	—	—	250	—
HSTT12-C‡	.125	3.2	.125	3.2	.062	1.6	.020	.5	—	—	100	30.5	1	10
HSTT12-M‡	.125	3.2	.125	3.2	.062	1.6	.020	.5	—	—	1000	304.8	1	2
HSTT19-48-Q	.187	4.8	.187	4.8	.093	2.4	.020	.5	4	1.2	—	—	25	—
HSTT19-48-TL	.187	4.8	.187	4.8	.093	2.4	.020	.5	4	1.2	—	—	250	—
HSTT19-C‡	.187	4.8	.187	4.8	.093	2.4	.020	.5	—	—	100	30.5	1	10
HSTT19-M‡	.187	4.8	.187	4.8	.093	2.4	.020	.5	—	—	1000	304.8	1	2
HSTT25-48-Q	.250	6.4	.250	6.4	.125	3.2	.025	.6	4	1.2	—	—	25	—
HSTT25-48-TL	.250	6.4	.250	6.4	.125	3.2	.025	.6	4	1.2	—	—	250	—
HSTT25-C‡	.250	6.4	.250	6.4	.125	3.2	.025	.6	—	—	100	30.5	1	10
HSTT25-D‡	.250	6.4	.250	6.4	.125	3.2	.025	.6	—	—	500	152.4	1	2
HSTT38-48-Q	.375	9.5	.375	9.5	.187	4.8	.025	.6	4	1.2	—	—	25	—
HSTT38-48-TL	.375	9.5	.375	9.5	.187	4.8	.025	.6	4	1.2	—	—	250	—
HSTT38-C‡	.375	9.5	.375	9.5	.187	4.8	.025	.6	—	—	100	30.5	1	10
HSTT38-T‡	.375	9.5	.375	9.5	.187	4.8	.025	.6	—	—	200	61.1	1	2

*For colors, add C (Clear), 2 (Red), 4 (Yellow), 45 (Yellow/Green), 5 (Green), 6 (Blue) and 10 (White) to end of part number.
 ‡Part sold per reel

HSTT Heat Shrink 4 Foot Pieces and Reels (continued)



Part Number*	Nominal Diameter		Min. Expanded I.D.		Max. Recovered I.D.		Nominal Recovered Wall Thickness		Length		Length per Reel		Std. Pkg. Qty.	Std. Ctn. Qty.
	In.	mm	In.	mm	In.	mm	In.	mm	Ft.	m	Ft.	m		
HSTT50-48-Q	.500	12.7	.500	12.7	.250	6.4	.025	.6	4	1.2	—	—	25	—
HSTT50-48-T	.500	12.7	.500	12.7	.250	6.4	.025	.6	4	1.2	—	—	200	—
HSTT50-C‡	.500	12.7	.500	12.7	.250	6.4	.025	.6	—	—	100	30.5	1	10
HSTT50-T‡	.500	12.7	.500	12.7	.250	6.4	.025	.6	—	—	200	61.1	1	2
HSTT75-48-5	.750	19.0	.750	19.0	.375	9.5	.030	.8	4	1.2	—	—	5	—
HSTT75-48-CQ	.750	19.0	.750	19.0	.375	9.5	.030	.8	4	1.2	—	—	125	—
HSTT75-T‡	.750	19.0	.750	19.0	.375	9.5	.030	.8	—	—	200	61.1	1	2
HSTT100-48-5	1.00	25.4	1.00	25.4	.500	12.7	.035	.9	4	1.2	—	—	5	—
HSTT100-48-LQ	1.00	25.4	1.00	25.4	.500	12.7	.035	.9	4	1.2	—	—	75	—
HSTT100-C‡	1.00	25.4	1.00	25.4	.500	12.7	.035	.9	—	—	100	30.5	1	2
HSTT150-48-5	1.50	38.1	1.50	38.1	.750	19.0	.040	1.0	4	1.2	—	—	5	—
HSTT150-C‡	1.50	38.1	1.50	38.1	.750	19.0	.040	1.0	—	—	100	30.5	1	2
HSTT200-48-5	2.00	50.8	2.00	50.8	1.00	25.4	.045	1.1	4	1.2	—	—	5	—
HSTT200-L‡	2.00	50.8	2.00	50.8	1.00	25.4	.045	1.1	—	—	50	15.2	1	2
HSTT300-48-2	3.00	76.2	3.00	76.2	1.50	38.1	.050	1.3	4	1.2	—	—	2	—
HSTT300-L‡	3.00	76.2	3.00	76.2	1.50	38.1	.050	1.3	—	—	50	15.2	1	1
HSTT400-48-2	4.00	101.6	4.00	101.6	2.00	50.8	.055	1.4	4	1.2	—	—	2	—
HSTT400-L‡	4.00	101.6	4.00	101.6	2.00	50.8	.055	1.4	—	—	50	15.2	1	1

*For colors, add C (Clear), 2 (Red), 4 (Yellow), 45 (Yellow/Green), 5 (Green), 6 (Blue) and 10 (White) to end of part number.
 ‡Part sold per reel

HSTT Heat Shrink on 25 Foot Reels

- Applications include insulating, protecting, and color coding wires and cables
- Voltage: 600 V
- Shrink ratio: 2:1
- Flammability: Flame retardant EXCEPT clear
- UL Recognized, CSA Certified
- Mil Spec: AMS-DTL-23053/5 Class 1 (Colors) Class 2 (Clear)
- Temperature range: -67°F to 275°F (-55°C to 135°C)
- For dry locations
- Material: Cross-linked Polyolefin



Part Number*	Nominal Diameter		Min. Expanded I.D.		Max. Recovered I.D.		Nominal Recovered Wall Thickness		Std. Pkg. Qty.	Std. Ctn. Qty.
	In.	mm	In.	mm	In.	mm	In.	mm		
HSTT05-Q	.046	1.2	.046	1.2	.023	.6	.016	.4	1	10
HSTT06-Q	.063	1.6	.063	1.6	.031	.8	.017	.4	1	10
HSTT09-Q	.093	2.4	.093	2.4	.046	1.2	.020	.5	1	10
HSTT12-Q	.125	3.2	.125	3.2	.062	1.6	.020	.5	1	10
HSTT19-Q	.187	4.8	.187	4.8	.093	2.4	.020	.5	1	10
HSTT25-Q	.250	6.4	.250	6.4	.125	3.2	.025	.6	1	10
HSTT38-Q	.375	9.5	.375	9.5	.187	4.8	.025	.6	1	10
HSTT50-Q	.500	12.7	.500	12.7	.250	6.4	.025	.6	1	10
HSTT75-Q	.750	19.0	.750	19.0	.375	9.5	.030	.8	1	10

*For colors, add C (Clear), 2 (Red), 4 (Yellow), 45 (Yellow/Green), 5 (Green), 6 (Blue), and 10 (White) to end of part number.

A. System Overview

B1. Cable Ties

B2. Cable Accessories

B3. Stainless Steel Ties

C1. Wiring Duct

C2. Surface Raceway

C3. Abrasion Protection

C4. Cable Management

D1. Terminals

D2. Power Connectors

D3. Grounding Connectors

E1. Labeling Systems

E2. Labels

E3. Pre-Printed & Write-On Markers

E4. Permanent Identification

E5. Lockout/Tagout & Safety Solutions

F. Index

A. System Overview

Heat Shrink in 6 Inch Pieces; Single Color, Single Diameter

B1. Cable Ties

- Applications include insulating, protecting, and color coding wires and cables
- Voltage: 600 V
- Shrink ratio: 2:1

- Mil Spec: AMS-DTL-23053/5 Class 1 (Colors) Class 2 (Clear)
- Temperature range: -67°F to 275°F (-55°C to 135°C)
- For dry locations
- Material: Cross-linked Polyolefin
- Colors include: Black and Clear

B2. Cable Accessories

- Flammability: Flame retardant EXCEPT clear
- UL Recognized, CSA Certified



B3. Stainless Steel Ties



C1. Wiring Duct

C2. Surface Raceway

C3. Abrasion Protection

C4. Cable Management

Part Number	Nominal Diameter		Min. Expanded I.D.		Max. Recovered I.D.		Nominal Recovered Wall Thickness		Std. Pkg. Qty.	Std. Ctn. Qty.
	In.	mm	In.	mm	In.	mm	In.	mm		
HSTT06-Y	.063	1.6	.063	1.6	.031	.8	.017	.4	1	10
HSTT09-Y	.093	2.4	.093	2.4	.046	1.2	.020	.5	1	10
HSTT12-Y	.125	3.2	.125	3.2	.062	1.6	.020	.5	1	10
HSTT19-Y	.187	4.8	.187	4.8	.093	2.4	.020	.5	1	10
HSTT25-Y	.250	6.4	.250	6.4	.125	3.2	.025	.6	1	10
HSTT38-Y	.375	9.5	.375	9.5	.187	4.8	.025	.6	1	10
HSTT50-Y	.500	12.7	.500	12.7	.250	6.4	.025	.6	1	10
HSTT75-Y	.750	19.0	.750	19.0	.375	9.5	.030	.8	1	10
HSTT100-Y	1.00	25.4	1.00	25.4	.500	12.7	.035	.9	1	10

**For colors add C (Clear), 2 (Red), 4 (Yellow), 5 (Green), 6 (Blue) and 10 (White) to suffix (Example: HSTT06-YC).

D1. Terminals

Heat Shrink in 6 Inch Pieces; Multi-Color, Single Diameter

D2. Power Connectors

- Applications include insulating, protecting, and color coding wires and cables
- Voltage: 600 V
- Shrink ratio: 2:1

- Mil Spec: AMS-DTL-23053/5 Class 1 (Colors) Class 2 (Clear)
- Temperature range: -67°F to 275°F (-55°C to 135°C)
- For dry locations
- Material: Cross-linked Polyolefin
- Colors include: clear, red, yellow, green, blue and white

D3. Grounding Connectors

- Flammability: Flame retardant EXCEPT clear
- UL Recognized, CSA Certified



E1. Labeling Systems



E2. Labels

E3. Pre-Printed & Write-On Markers

E4. Permanent Identification

E5. Lockout/Tagout & Safety Solutions

F. Index

Part Number	Nominal Diameter		Min. Expanded I.D.		Max. Recovered I.D.		Black No. of Pieces	Each Color No. of Pieces	Std. Pkg. Qty.	Std. Ctn. Qty.
	In.	mm	In.	mm	In.	mm				
HSTT06-YK1	.063	1.6	.063	1.6	.031	0.8	8	3	1	10
HSTT09-YK1	.093	2.4	.093	2.4	.046	1.2	6	3	1	10
HSTT12-YK1	.125	3.2	.125	3.2	.062	1.6	2	3	1	10
HSTT19-YK1	.187	4.8	.187	4.8	.093	2.4	6	2	1	10
HSTT25-YK1	.250	6.4	.250	6.4	.125	3.2	2	2	1	10
HSTT38-YK1	.375	9.5	.375	9.5	.187	4.8	6	1	1	10
HSTT50-YK1	.500	12.7	.500	12.7	.250	6.4	4	1	1	10
HSTT75-YK1	.750	19.0	.750	19.0	.375	9.5	2	1	1	10
HSTT100-YK1	1.00	25.4	1.00	25.4	.500	12.7	1	1	1	10

Heat Shrink in 6 Inch Pieces; Black, Multiple Diameters

- Applications include insulating, protecting, and color coding wires and cables
- Voltage: 600 V
- Shrink ratio: 2:1
- UL Recognized, CSA Certified
- Mil Spec: AMS-DTL-23053/5 Class 1 (Colors) Class 2 (Clear)
- Temperature range: -67°F to 275°F (-55°C to 135°C)
- For dry locations
- Material: Cross-linked Polyolefin



Part Number	Nominal Diameter	No. of Pieces by Diameter	Std. Pkg. Qty.	Std. Ctn. Qty.
HSTT-YK1	Various – Smaller Range	Two pcs. each 1/8", 1/16", 3/32", 1/8", 3/16", 3/8", 1/2"	1	10
HSTT-YK2	Various – Larger Range	Two pcs. each 3/8", 1/2", 3/4", 1"	1	10

Heat Shrink in 6 Inch Pieces; Yellow/Green Stripe, Multiple Diameters

- Applications include insulating, protecting, and color coding wires and cables
- Voltage: 600 V
- Shrink ratio: 2:1
- Flammability: Flame retardant
- UL Recognized, CSA Certified
- Mil Spec: AMS-DTL-23053/5 Class 1
- Temperature range: -67°F to 275°F (-55°C to 135°C)
- For dry locations
- Material: Cross-linked Polyolefin



Part Number	Nominal Diameter	No. of Pieces by Diameter	Std. Pkg. Qty.	Std. Ctn. Qty.
HSTT-YK1-45	Various – Smaller Range	Two pcs. each 1/8", 3/16", 1/4", 3/8"	1	10
HSTT-YK2-45	Various – Larger Range	Two pcs. each 3/8", 1/2", 3/4"	1	10

A.
System
Overview

B1.
Cable
Ties

B2.
Cable
Accessories

B3.
Stainless
Steel Ties

C1.
Wiring
Duct

C2.
Surface
Raceway

C3.
Abrasion
Protection

C4.
Cable
Management

D1.
Terminals

D2.
Power
Connectors

D3.
Grounding
Connectors

E1.
Labeling
Systems

E2.
Labels

E3.
Pre-Printed
& Write-On
Markers

E4.
Permanent
Identification

E5.
Lockout/
Tagout
& Safety
Solutions

F.
Index

A.
System
Overview

HSTTV Heat Shrink 4 Foot Pieces

B1.
Cable Ties

- Applications include insulating, protecting, and color coding wires and cables
- Fast shrink time
- Voltage: 600 V
- Shrink ratio: 2:1
- Flammability: Meets UL 224 VW-1
- UL Recognized, CSA Certified
- Mil Spec: AMS-DTL-23053/5 Class 3
- Temperature range: -67°F to 275°F (-55°C to 135°C)
- For dry locations
- Material: Black cross-linked Polyolefin

B2.
Cable
Accessories

B3.
Stainless
Steel Ties



C1.
Wiring
Duct

C2.
Surface
Raceway

C3.
Abrasion
Protection

C4.
Cable
Management

D1.
Terminals

D2.
Power
Connectors

D3.
Grounding
Connectors

E1.
Labeling
Systems

E2.
Labels

E3.
Pre-Printed
& Write-On
Markers

E4.
Permanent
Identification

E5.
Lockout/
Tagout/
& Safety
Solutions

F.
Index



Part Number	Nominal Diameter		Min. Expanded I.D.		Max. Recovered I.D.		Nominal Recovered Wall Thickness		Std. Pkg. Qty.	Std. Ctn. Qty.
	In.	mm	In.	mm	In.	mm	In.	mm		
HSTTV05-48-Q	.046	1.2	.046	1.2	.023	0.6	.016	0.4	25	—
HSTTV05-48-TL	.046	1.2	.046	1.2	.023	0.6	.016	0.4	250	—
HSTTV06-48-Q	.063	1.6	.063	1.6	.031	0.8	.017	0.4	25	—
HSTTV06-48-TL	.063	1.6	.063	1.6	.031	0.8	.017	0.4	250	—
HSTTV09-48-Q	.093	2.4	.093	2.4	.046	1.2	.020	0.5	25	—
HSTTV09-48-TL	.093	2.4	.093	2.4	.046	1.2	.020	0.5	250	—
HSTTV12-48-Q	.125	3.2	.125	3.2	.062	1.6	.020	0.5	25	—
HSTTV12-48-TL	.125	3.2	.125	3.2	.062	1.6	.020	0.5	250	—
HSTTV19-48-Q	.187	4.8	.187	4.8	.093	2.4	.020	0.5	25	—
HSTTV19-48-TL	.187	4.8	.187	4.8	.093	2.4	.020	0.5	250	—
HSTTV25-48-Q	250	6.4	.250	6.4	.125	3.2	.025	0.6	25	—
HSTTV25-48-TL	.250	6.4	.250	6.4	.125	3.2	.025	0.6	250	—
HSTTV38-48-Q	.375	9.5	.375	9.5	.187	4.8	.025	0.6	25	—
HSTTV38-48-TL	.375	9.5	.375	9.5	.187	4.8	.025	0.6	250	—
HSTTV50-48-Q	500	12.7	.500	12.7	.250	6.4	.025	0.6	25	—
HSTTV50-48-T	.500	12.7	.500	12.7	.250	6.4	.025	0.6	200	—
HSTTV75-48-5	.750	19.0	.75	19.0	.375	9.5	.030	0.8	5	—
HSTTV75-48-CQ	750	19.0	.75	19.0	.375	9.5	.030	0.8	125	—
HSTTV100-48-5	1.00	25.4	1.00	25.4	.500	12.7	.035	0.9	5	—
HSTTV100-48-LQ	1.00	25.4	1.00	25.4	.500	12.7	.035	0.9	75	—
HSTTV150-48-5	1.50	38.1	1.50	38.1	.750	19.0	.040	1.0	5	—

HSTTV Heat Shrink on 100 Foot Reels

- Applications include insulating, protecting, and color coding wires and cables
- Fast shrink time
- Voltage: 600 V
- Shrink ratio: 2:1
- Flammability: Meets UL 224 VW-1
- UL Recognized, CSA Certified
- Mil Spec: AMS-DTL-23053/5 Class 3
- Temperature range: -67°F to 275°F (-55°C to 135°C)
- For dry locations
- Material: Cross-linked Polyolefin UV Resistant



Part Number	Nominal Diameter		Min. Expanded I.D.		Max. Recovered I.D.		Nominal Recovered Wall Thickness		Std. Pkg. Qty.	Std. Ctn. Qty.
	In.	mm	In.	mm	In.	mm	In.	mm		
HSTTV05-C	.046	1.2	.046	1.2	.023	0.6	.016	0.4	1	10
HSTTV06-C	.063	1.6	.063	1.6	.031	0.8	.017	0.4	1	10
HSTTV09-C	.093	2.4	.093	2.4	.046	1.2	.020	0.5	1	10
HSTTV12-C	.125	3.2	.125	3.2	.062	1.6	.020	0.5	1	10
HSTTV19-C	.187	4.8	.187	4.8	.093	2.4	.020	0.5	1	10
HSTTV25-C	.250	6.4	.250	6.4	.125	3.2	.025	0.6	1	10
HSTTV38-C	.375	9.5	.375	9.5	.187	4.8	.025	0.6	1	10
HSTTV50-C	.500	12.7	.500	12.7	.250	6.4	.025	0.6	1	10
HSTTV75-C	.750	19.0	.750	19.0	.375	9.5	.030	0.8	1	10
HSTTV100-C	1.00	25.4	1.00	25.4	.500	12.7	.035	0.9	1	2
HSTTV150-C	1.50	38.1	1.50	38.1	.750	19.0	.040	1.0	1	2

A.
System
Overview

B1.
Cable Ties

B2.
Cable
Accessories

B3.
Stainless
Steel Ties

C1.
Wiring
Duct

C2.
Surface
Raceway

C3.
Abrasion
Protection

C4.
Cable
Management

D1.
Terminals

D2.
Power
Connectors

D3.
Grounding
Connectors

E1.
Labeling
Systems

E2.
Labels

E3.
Pre-Printed
& Write-On
Markers

E4.
Permanent
Identification

E5.
Lockout/
Tagout/
& Safety
Solutions

F.
Index

A.
System
Overview

HSTTV Heat Shrink on Bulk Reels

B1.
Cable Ties

- Applications include insulating, protecting, and color coding wires and cables
- Fast shrink time
- Voltage: 600 V
- Shrink ratio: 2:1
- Flammability: Meets UL 224 VW-1
- UL Recognized, CSA Certified
- Mil Spec: AMS-DTL-23053/5 Class 3
- Temperature range: -67°F to 275°F (-55°C to 135°C)
- For dry locations
- Material: Cross-linked Polyolefin

B2.
Cable
Accessories



B3.
Stainless
Steel Ties

C1.
Wiring
Duct



C2.
Surface
Raceway

C3.
Abrasion
Protection

C4.
Cable
Management

D1.
Terminals

D2.
Power
Connectors

D3.
Grounding
Connectors

E1.
Labeling
Systems

E2.
Labels

E3.
Pre-Printed
& Write-On
Markers

E4.
Permanent
Identification

E5.
Lockout/
Tagout
& Safety
Solutions

F.
Index

Part Number	Nominal Diameter		Min. Expanded I.D.		Max. Recovered I.D.		Nominal Recovered Wall Thickness		Length per Reel		Color	Std. Pkg. Qty.	Std. Ctn. Qty.
	In.	mm	In.	mm	In.	mm	In.	mm	Ft.	m			
HSTTV05-M	.046	1.2	.046	1.2	.023	0.6	.016	0.4	1000	304.8	Black	1	2
HSTTV05-M2	.046	1.2	.046	1.2	.023	0.6	.016	0.4	1000	304.8	Red	1	2
HSTTV05-M4	.046	1.2	.046	1.2	.023	0.6	.016	0.4	1000	304.8	Yellow	1	2
HSTTV05-M6	.046	1.2	.046	1.2	.023	0.6	.016	0.4	1000	304.8	Blue	1	2
HSTTV06-M	.063	1.6	.063	1.6	.031	0.8	.017	0.4	1000	304.8	Black	1	2
HSTTV06-M2	.063	1.6	.063	1.6	.031	0.8	.017	0.4	1000	304.8	Red	1	2
HSTTV06-M4	.063	1.6	.063	1.6	.031	0.8	.017	0.4	1000	304.8	Yellow	1	2
HSTTV06-M6	.063	1.6	.063	1.6	.031	0.8	.017	0.4	1000	304.8	Blue	1	2
HSTTV09-M	.093	2.4	.093	2.4	.046	1.2	.02	0.5	1000	304.8	Black	1	2
HSTTV09-M2	.093	2.4	.093	2.4	.046	1.2	.02	0.5	1000	304.8	Red	1	2
HSTTV09-M4	.093	2.4	.093	2.4	.046	1.2	.02	0.5	1000	304.8	Yellow	1	2
HSTTV09-M6	.093	2.4	.093	2.4	.046	1.2	.02	0.5	1000	304.8	Blue	1	2
HSTTV12-M	.125	3.2	.125	3.2	.062	1.6	.02	0.5	1000	304.8	Black	1	2
HSTTV12-M2	.125	3.2	.125	3.2	.062	1.6	.02	0.5	1000	304.8	Red	1	2
HSTTV12-M4	.125	3.2	.125	3.2	.062	1.6	.02	0.5	1000	304.8	Yellow	1	2
HSTTV12-M6	.125	3.2	.125	3.2	.062	1.6	.02	0.5	1000	304.8	Blue	1	2
HSTTV19-M	.187	4.8	.187	4.8	.093	2.4	.02	0.5	1000	304.8	Black	1	2
HSTTV19-M2	.187	4.8	.187	4.8	.093	2.4	.02	0.5	1000	304.8	Red	1	2
HSTTV19-M4	.187	4.8	.187	4.8	.093	2.4	.02	0.5	1000	304.8	Yellow	1	2
HSTTV19-M6	.187	4.8	.187	4.8	.093	2.4	.02	0.5	1000	304.8	Blue	1	2
HSTTV25-D	.250	6.4	.250	6.4	.125	3.2	.025	0.6	500	152.4	Black	1	2
HSTTV25-D2	.250	6.4	.250	6.4	.125	3.2	.025	0.6	500	152.4	Red	1	2
HSTTV25-D4	.250	6.4	.250	6.4	.125	3.2	.025	0.6	500	152.4	Yellow	1	2
HSTTV25-D6	.250	6.4	.250	6.4	.125	3.2	.025	0.6	500	152.4	Blue	1	2
HSTTV38-T	.375	9.5	.375	9.5	.187	4.8	.025	0.6	200	61.1	Black	1	2
HSTTV38-T2	.375	9.5	.375	9.5	.187	4.8	.025	0.6	200	61.1	Red	1	2
HSTTV38-T4	.375	9.5	.375	9.5	.187	4.8	.025	0.6	200	61.1	Yellow	1	2
HSTTV38-T6	.375	9.5	.375	9.5	.187	4.8	.025	0.6	200	61.1	Blue	1	2
HSTTV50-T	.500	12.7	.500	12.7	.250	6.4	.025	0.6	200	61.1	Black	1	2
HSTTV50-T2	.500	12.7	.500	12.7	.250	6.4	.025	0.6	200	61.1	Red	1	2
HSTTV50-T4	.500	12.7	.500	12.7	.250	6.4	.025	0.6	200	61.1	Yellow	1	2
HSTTV50-T6	.500	12.7	.500	12.7	.250	6.4	.025	0.6	200	61.1	Blue	1	2
HSTTV75-T	.750	19.0	.750	19.0	.375	9.5	.03	0.8	200	61.1	Black	1	2
HSTTV75-T2	.750	19.0	.750	19.0	.375	9.5	.03	0.8	200	61.1	Red	1	2
HSTTV75-T4	.750	19.0	.750	19.0	.375	9.5	.03	0.8	200	61.1	Yellow	1	2
HSTTV75-T6	.750	19.0	.750	19.0	.375	9.5	.03	0.8	200	61.1	Blue	1	2

UL® SP® HSTTV Heat Shrink on 25 Foot Reels

- Applications include insulating, protecting, and color coding wires and cables
- Fast shrink time
- Voltage: 600 V
- Shrink ratio: 2:1
- Flammability: Meets UL 224 VW-1
- UL Recognized, CSA Certified
- Mil Spec: AMS-DTL-23053/5 Class 3
- Temperature range: -67°F to 275°F (-55°C to 135°C)
- For dry locations
- Material: Black cross-linked Polyolefin



Part Number	Nominal Diameter		Min. Expanded I.D.		Max. Recovered I.D.		Nominal Recovered Wall Thickness		Std. Pkg. Qty.	Std. Ctn. Qty.
	In.	mm	In.	mm	In.	mm	In.	mm		
HSTTV05-Q	.046	1.2	.046	1.2	.023	0.6	.016	0.4	1	10
HSTTV06-Q	.063	1.6	.063	1.6	.031	0.8	.017	0.4	1	10
HSTTV09-Q	.093	2.4	.093	2.4	.046	1.2	.020	0.5	1	10
HSTTV12-Q	.125	3.2	.125	3.2	.062	1.6	.020	0.5	1	10
HSTTV19-Q	.187	4.8	.187	4.8	.093	2.4	.020	0.5	1	10
HSTTV25-Q	.250	6.4	.250	6.4	.125	3.2	.025	0.6	1	10
HSTTV38-Q	.375	9.5	.375	9.5	.187	4.8	.025	0.6	1	10
HSTTV50-Q	.500	12.7	.500	12.7	.250	6.4	.025	0.6	1	10
HSTTV75-Q	.750	19.0	.750	19.0	.375	9.5	.030	0.8	1	10
HSTTV100-Q	1.00	25.4	1.00	25.4	.500	12.7	.035	0.9	1	2

UL® SP® HSTTV Heat Shrink 6 Inch Pieces

- Applications include insulating, protecting, and color coding wires and cables
- Fast shrink time
- Voltage: 600 V
- Shrink ratio: 2:1
- Flammability: Meets UL 224 VW-1
- UL Recognized, CSA Certified
- Mil Spec: AMS-DTL-23053/5 Class 3
- Temperature range: -67°F to 275°F (-55°C to 135°C)
- For dry locations
- Material: Black cross-linked Polyolefin



Part Number	Nominal Diameter / Size		Min. Expanded I.D.		Max. Recovered I.D.		Pieces per Package	Std. Pkg. Qty.	Std. Ctn. Qty.
	In.	mm	In.	mm	In.	mm			
HSTTV05-Y	.046	1.2	.046	1.2	.023	0.6	26	1	10
HSTTV06-Y	.063	1.6	.063	1.6	.031	0.8	26	1	10
HSTTV09-Y	.093	2.4	.093	2.4	.046	1.2	24	1	10
HSTTV12-Y	.125	3.2	.125	3.2	.062	1.6	20	1	10
HSTTV19-Y	.187	4.8	.187	4.8	.093	2.4	18	1	10
HSTTV25-Y	.250	6.4	.250	6.4	.125	3.2	14	1	10
HSTTV38-Y	.375	9.5	.375	9.5	.187	4.8	12	1	10
HSTTV50-Y	.500	12.7	.500	12.7	.250	6.4	10	1	10
HSTTV75-Y	.750	19.0	.750	19.0	.375	9.5	8	1	10
HSTTV100-Y	1.00	25.4	1.00	25.4	.500	12.7	6	1	10

A. System Overview

B1. Cable Ties

B2. Cable Accessories

B3. Stainless Steel Ties

C1. Wiring Duct

C2. Surface Raceway

C3. Abrasion Protection

C4. Cable Management

D1. Terminals

D2. Power Connectors

D3. Grounding Connectors

E1. Labeling Systems

E2. Labels

E3. Pre-Printed & Write-On Markers

E4. Permanent Identification

E5. Lockout/Tagout & Safety Solutions

F. Index

A. System Overview

HSTTP PVC Heat Shrink

B1. Cable Ties

- Applications include insulating, protecting, and color coding wires and cables
- Good resistance to most fuels and oils
- Voltage: 600 V
- Shrink ratio: 2:1

- Flammability: Meets UL 224 VW-1
- UL Recognized, CSA Certified
- Temperature range: -4°F to 221°F (-20°C to 105°C)
- For dry locations
- Material: Black cross-linked Polyvinyl Chloride

B2. Cable Accessories

B3. Stainless Steel Ties



C1. Wiring Duct

C2. Surface Raceway

C3. Abrasion Protection

C4. Cable Management

D1. Terminals

D2. Power Connectors

D3. Grounding Connectors

E1. Labeling Systems

E2. Labels

E3. Pre-Printed & Write-On Markers

E4. Permanent Identification

E5. Lockout/Tagout & Safety Solutions

F. Index



Part Number	Nominal Diameter		Min. Expanded I.D.		Max. Recovered I.D.		Nominal Recovered Wall Thickness		Length per reel		Std. Pkg. Qty.	Std. Ctn. Qty.
	In.	mm	In.	mm	In.	mm	In.	mm	Ft.	m		
HSTTP05-QY	.046	1.2	.046	1.2	.023	0.6	.020	0.5	25	7.5	1	10
HSTTP05-CY	.046	1.2	.046	1.2	.023	0.6	.020	0.5	100	30.5	1	2
HSTTP05-MY	.046	1.2	.046	1.2	.023	0.6	.020	0.5	1000	304.8	1	2
HSTTP06-QY	.063	1.6	.063	1.6	.031	0.8	.020	0.5	25	7.5	1	10
HSTTP06-CY	.063	1.6	.063	1.6	.031	0.8	.020	0.5	100	30.5	1	2
HSTTP06-MY	.063	1.6	.063	1.6	.031	0.8	.020	0.5	1000	304.8	1	2
HSTTP09-QY	.093	2.4	.093	2.4	.046	1.2	.025	0.6	25	7.5	1	10
HSTTP09-CY	.093	2.4	.093	2.4	.046	1.2	.025	0.6	100	30.5	1	2
HSTTP09-MY	.093	2.4	.093	3/32	.046	1.2	.025	0.6	1000	304.8	1	2
HSTTP12-QY	.125	3.2	.125	3.2	.062	1.6	.025	0.6	25	7.5	1	10
HSTTP12-CY	.125	3.2	.125	3.2	.062	1.6	.025	0.6	100	30.5	1	2
HSTTP12-MY	.125	3.2	.125	3.2	.062	1.6	.025	0.6	1000	304.8	1	2
HSTTP19-QY	.187	4.8	.187	4.8	.093	2.4	.025	0.6	25	7.5	1	10
HSTTP19-CY	.187	4.8	.187	4.8	.093	2.4	.025	0.6	100	30.5	1	2
HSTTP19-MY	.187	4.8	.187	4.8	.093	2.4	.025	0.6	1000	304.8	1	2
HSTTP25-QY	.250	6.4	.250	6.4	.125	3.2	.025	0.6	25	7.5	1	10
HSTTP25-CY	.250	6.4	.250	6.4	.125	3.2	.025	0.6	100	30.5	1	2
HSTTP25-DY	.250	6.4	.250	6.4	.125	3.2	.025	0.6	500	152.4	1	2
HSTTP38-QY	.375	9.5	.375	9.5	.187	4.8	.030	0.8	25	7.5	1	10
HSTTP38-CY	.375	9.5	.375	9.5	.187	4.8	.030	0.8	100	30.5	1	2
HSTTP38-TY	.375	9.5	.375	9.5	.187	4.8	.030	0.8	200	61.1	1	2
HSTTP50-QY	.500	12.7	.500	12.7	.250	6.4	.030	0.8	25	7.5	1	10
HSTTP50-CY	.500	12.7	.500	12.7	.250	6.4	.030	0.8	100	30.5	1	2
HSTTP75-QY	.750	19.0	.750	19.0	.375	9.5	.035	0.9	25	7.5	1	10
HSTTP75-CY	.750	19.0	.750	19.0	.375	9.5	.035	0.9	100	30.5	1	2
HSTTP100-QY	1.00	25.4	1.00	25.4	.500	12.7	.040	1.0	25	7.5	1	2
HSTTP100-CY	1.00	25.4	1.00	25.4	.500	12.7	.040	1.0	100	30.5	1	2
HSTTP150-QY	1.50	38.1	1.50	38.1	.750	19.0	.045	1.1	25	7.5	1	2
HSTTP150-CY	1.50	38.1	1.50	38.1	.750	19.0	.045	1.1	100	30.5	1	2
HSTTP200-QY	2.00	50.8	2.00	50.8	1.00	25.4	.050	1.3	25	7.5	1	2

HSTTPN Crystal Clear PVC Heat Shrink



- Low shrink temperature (store below 90° F) to speed installation
- Crystal clear material ensures easy to read labels and splice inspections
- Mil Spec: AMS-DTL-23052/2 Class 2
- Highly flame retardant product manufactured from a material that is rated UL 224 VW-1
- Shrink ratio of 2:1 insulates a wide range of diameters and irregular shapes



Part Number	Nominal Diameter		Min. Expanded I.D.		Max. Recovered I.D.		Nominal Recovered Wall Thickness		Length		Length per Reel		Std. Pkg. Qty.	Std. Ctn. Qty.
	In.	mm	In.	mm	In.	mm	In.	mm	In.	mm	Ft.	m		
HSTTPN50-438-L	.50	12.7	.50	12.7	.25	6.4	.03	0.8	4.38	111.1	—	—	50	500
HSTTPN50-713-Q	.50	12.7	.50	12.7	.25	6.4	.30	0.8	7.13	181.0	—	—	25	250
HSTTPN62-750-Q	.63	15.9	.63	15.9	.31	7.9	.04	1.0	7.5	190.5	—	—	25	250
HSTTPN75-775-Q	.75	19.1	.75	19.1	.38	9.5	.04	1.0	7.8	197.0	—	—	25	250
HSTTPN150-925-X	1.5	38.1	1.5	38.1	.75	19.1	.05	1.3	9.3	235.0	—	—	10	100
HSTTPN200-950-X	2.0	50.8	2.0	50.8	1.0	25.4	.05	1.3	10.0	241.3	—	—	10	100
HSTTPN50-CC	.50	12.7	.50	12.7	.25	6.4	.03	0.8	—	—	100	30.5	1	2
HSTTPN62-CC	.63	15.9	.63	15.9	.31	7.9	.04	1.0	—	—	100	30.5	1	2
HSTTPN75-CC	.75	19.1	.75	19.05	.38	9.5	.04	1.0	—	—	100	30.5	1	2
HSTTPN100-CC	1.0	25.4	1.0	25.4	.50	12.7	.04	1.0	—	—	100	30.5	1	2
HSTTPN150-CC	1.5	38.1	1.5	38.1	.75	19.1	.05	1.3	—	—	100	30.5	1	2
HSTTPN100-775-Q	1.0	25.4	1.0	25.4	.50	12.7	.04	1.0	7.8	197.0	—	—	25	250
HSTTPN200-CC	2.0	50.8	2.0	50.8	1.0	25.4	.05	1.3	—	—	100	30.5	1	2

HSTTN Neoprene Heat Shrink

- Applications include insulating, protecting, and color coding wires and cables
- Excellent chemical resistance especially to fuels and oils
- Voltage: 600 V
- Shrink ratio: 2:1
- Mil Spec: AMS-DTL-23053/1 Class 2
- Temperature range: -94°F to 250°F (-70°C to 121°C)
- For dry locations
- Material: Black cross-linked Neoprene



Part Number	Nominal Diameter		Min. Expanded I.D.		Max. Recovered I.D.		Nominal Recovered Wall Thickness		Length per Reel		Std. Pkg. Qty.	Std. Ctn. Qty.
	In.	mm	In.	mm	In.	mm	In.	mm	Ft.	m		
HSTTN25-C	.250	6.4	.250	6.4	.143	3.6	.035	0.9	100	30.5	1	2
HSTTN38-C	.375	9.5	.375	9.5	.211	5.4	.040	1.0	100	30.5	1	2
HSTTN50-C	.500	12.7	.500	12.7	.286	7.3	.048	1.2	100	30.5	1	2
HSTTN63-C	.625	15.9	.625	15.9	.357	9.1	.052	1.3	100	30.5	1	2
HSTTN75-C	.750	19.0	.750	19.0	.428	10.9	.057	1.5	100	30.5	1	2
HSTTN88-C	.875	22.2	.875	22.2	.500	12.7	.065	1.7	100	30.5	1	2
HSTTN100-C	1.00	25.4	1.00	25.4	.570	14.5	.070	1.8	100	30.5	1	2
HSTTN125-C	1.25	31.8	1.25	31.8	.714	18.1	.087	2.2	100	30.5	1	2
HSTTN150-C	1.50	38.1	1.50	38.1	.875	21.8	.095	2.4	100	30.5	1	2
HSTTN200-Q	2.00	50.8	2.00	50.8	1.14	29.0	.110	2.8	25	7.5	1	2
HSTTN300-Q	3.00	76.2	3.00	76.2	1.71	43.4	.125	3.8	25	7.5	1	2

A. System Overview

TEFLON[®] Heat Shrink

B1. Cable Ties

- Applications include insulating, protecting, and color coding wires and cables
- Voltage: 600 V
- Shrink ratio: 2:1
- Mil Spec: AMS-DTL-23053/12 Class 3
- Temperature range: -400°F to 500°F (-240°C to 260°C)
- Color: Opaque
- For dry locations
- Material: Polytetrafluoroethylene (PTFE)
- See page C3.39 for shrink instructions

B2. Cable Accessories

B3. Stainless Steel Ties

C1. Wiring Duct

C2. Surface Raceway

C3. Abrasion Protection

C4. Cable Management

D1. Terminals

D2. Power Connectors

D3. Grounding Connectors

E1. Labeling Systems

E2. Labels

E3. Pre-Printed & Write-On Markers

E4. Permanent Identification

E5. Lockout/Tagout & Safety Solutions

F. Index



Part Number	Nominal Diameter		Min. Expanded I.D.		Max. Recovered I.D.		Nominal Recovered Wall Thickness		Length		Std. Pkg. Qty.
	In.	mm	In.	mm	In.	mm	In.	mm	Ft.	m	
HSTTT03-48-Q	30 AWG	0.9	.034	.9	.015	.4	.009	.2	4	1.2	25
HSTTT04-48-Q	28 AWG	1.0	.038	1.0	.018	.5	.009	.2	4	1.2	25
HSTTT046-48-Q	26 AWG	1.2	.046	1.2	.022	.5	.010	.3	4	1.2	25
HSTTT05-48-Q	24 AWG	1.3	.050	1.3	.027	.7	.010	.3	4	1.2	25
HSTTT055-48-Q	22 AWG	1.4	.055	1.4	.032	.8	.012	.3	4	1.2	25
HSTTT06-48-Q	20 AWG	1.5	.060	1.5	.039	1.0	.012	.3	4	1.2	25
HSTTT08-48-Q	18 AWG	1.9	.076	1.9	.049	1.2	.012	.3	4	1.2	25
HSTTT09-48-Q	16 AWG	2.3	.093	2.3	.061	1.6	.012	.3	4	1.2	25
HSTTT12-48-Q	14 AWG	3.0	.120	3.0	.072	1.8	.012	.3	4	1.2	25
HSTTT15-48-Q	12 AWG	3.8	.150	3.8	.089	2.3	.012	.3	4	1.2	25
HSTTT19-48-Q	10 AWG	4.9	.191	4.9	.112	2.8	.012	.3	4	1.2	25
HSTTT24-48-Q	8 AWG	6.0	.240	6.0	.141	3.6	.015	.4	4	1.2	25
HSTTT30-48-Q	6 AWG	7.7	.302	7.7	.178	4.5	.015	.4	4	1.2	25
HSTTT37-48-Q	4 AWG	9.4	.370	9.4	.224	5.7	.015	.4	4	1.2	25
HSTTT43-48-Q	2 AWG	10.9	.430	10.9	.278	7.0	.015	.4	4	1.2	25
HSTTT47-48-Q	0 AWG	11.9	.470	11.9	.347	8.8	.015	.4	4	1.2	25
HSTTT56-48-5	9/16	14.2	.560	14.2	.399	10.1	.015	.4	4	1.2	5
HSTTT66-48-5	5/8	16.6	.655	16.6	.462	11.7	.018	.5	4	1.2	5
HSTTT75-48-5	3/4	19.0	.750	19.0	.524	13.3	.018	.5	4	1.2	5
HSTTT93-48-5	15/16	23.6	.930	23.6	.655	16.6	.020	.5	4	1.2	5
HSTTT112-48-5	1 1/8	28.6	1.12	26.6	.786	20.0	.025	.6	4	1.2	5
HSTTT131-48-2	1 5/16	33.3	1.310	33.3	.911	23.1	.030	.8	4	1.2	2
HSTTT150-48-2	1 1/2	38.1	1.500	38.1	1.036	26.3	.030	.8	4	1.2	2

*TEFLON is a registered trademark of E.I. du Pont de Nemours and Company.

UL® CS® HSTTK Kynar* Heat Shrink 4 Foot Pieces

- Applications include insulating, protecting, and color coding wires and cables
- Excellent chemical and abrasion resistance
- Use in high temperature or solvent rich environment
- Voltage: 600 V
- Shrink ratio: 2:1
- Flammability: Meets UL 224 VW-1
- Mil Spec: AMS-DTL-23053/8
- Temperature range: -67°F to 347°F (-55°C to 175°C)
- For dry locations
- Material: Cross-linked Polyvinylidene Fluoride (PVDF)

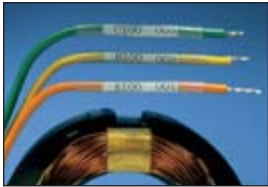

Part Number	Nominal Diameter		Min. Expanded I.D.		Max. Recovered I.D.		Nominal Recovered Wall Thickness		Std. Pkg. Qty.
	In.	mm	In.	mm	In.	mm	In.	mm	
HSTTK05-48-Q	.046	1.2	.046	1.2	.023	0.6	.010	0.3	25
HSTTK06-48-Q	.063	1.6	.063	1.6	.031	0.8	.010	0.3	25
HSTTK09-48-Q	.093	2.4	.093	2.4	.046	1.2	.010	0.3	25
HSTTK12-48-Q	.125	3.2	.125	3.2	.062	1.6	.010	0.3	25
HSTTK19-48-Q	.187	4.8	.187	4.8	.093	2.4	.010	0.3	25
HSTTK25-48-Q	.250	6.4	.250	6.4	.125	3.2	.010	0.3	25
HSTTK38-48-Q	.375	9.5	.375	9.5	.187	4.8	.012	0.3	25
HSTTK50-48-5	.500	12.7	.500	12.7	.250	6.4	.012	0.3	5
HSTTK75-48-5	.750	19.0	.750	19.0	.375	9.5	.017	0.4	5
HSTTK100-48-5	1.00	25.4	1.00	25.4	.500	12.7	.019	0.5	5

*KYNAR is a registered trademark of Atofina Chemicals, Inc.

HSTTVA Heat Shrink 4 Foot and 6 Inch Pieces

- Applications include insulating, protecting, and color coding wires and cables
- Flexible tubing with an adhesive inner wall which seals and protects components from moisture and corrosion
- Voltage rating: 600 V
- Shrink ratio: 2:1
- Flammability: Highly flame retardant outer wall meets UL 224 VW-1
- Mil Spec: AMS-DTL-23053/4 Class 2
- Temperature range: -67°F to 230°F (-55°C to 110°C)
- For damp locations
- Material: Adhesive lined black cross-linked Polyolefin



Part Number	Nominal Diameter		Min. Expanded I.D.		Max. Recovered I.D.		Nominal Recovered Wall Thickness		Std. Pkg. Qty.
	In.	mm	In.	mm	In.	mm	In.	mm	
4' pieces									
HSTTVA12-48-Q	.125	3.2	.125	3.2	.062	1.6	.020	0.5	25
HSTTVA19-48-Q	.187	4.8	.187	4.8	.093	2.4	.022	0.6	25
HSTTVA25-48-Q	.250	6.4	.250	6.4	.125	3.2	.030	0.8	25
HSTTVA38-48-Q	.375	9.5	.375	9.5	.187	4.8	.031	0.8	25
HSTTVA50-48-5	.500	12.7	.500	12.7	.250	6.4	.032	0.8	5
HSTTVA75-48-5	.750	19.0	.750	19.0	.375	9.5	.037	0.9	5
HSTTVA100-48-5	1.00	25.4	1.00	25.4	.500	12.7	.046	1.2	5
HSTTVA150-48-5	1.50	38.1	1.50	38.1	.750	19.0	.049	1.2	5

Table continues on page C3.34

A. System Overview

HSTTVA Heat Shrink 4 Foot and 6 Inch Pieces (continued)

B1. Cable Ties

B2. Cable Accessories

B3. Stainless Steel Ties

C1. Wiring Duct

C2. Surface Raceway

C3. Abrasion Protection

C4. Cable Management

Part Number	Nominal Diameter		Min. Expanded I.D.		Max. Recovered I.D.		Nominal Recovered Wall Thickness		Std. Pkg. Qty.
	In.	mm	In.	mm	In.	mm	In.	mm	
Standard Packs of HSTTVA Heat Shrink – 6" (152.4mm) Pieces									
HSTTVA12-Y	.125	3.2	.125	3.2	.062	1.6	.020	0.5	1
HSTTVA19-Y	.187	4.8	.187	4.8	.093	2.4	.022	0.6	1
HSTTVA25-Y	.250	6.4	.250	6.4	.125	3.2	.030	0.8	1
HSTTVA38-Y	.375	9.5	.375	9.5	.187	4.8	.031	0.8	1
HSTTVA50-Y	.500	12.7	.500	12.7	.250	6.4	.032	0.8	1
HSTTVA75-Y	.750	19.0	.750	19.0	.375	9.5	.037	0.9	1
HSTTVA100-Y	1.00	25.4	1.00	25.4	.500	12.7	.046	1.2	1

HSTTA Heat Shrink 4 Foot and 6 Inch Pieces

- Applications include insulating, protecting, and color coding wires and cables
- Flexible tubing with an adhesive inner wall which seals and protects components from moisture and corrosion
- Voltage rating: 600 V
- Shrink ratio: 3:1
- Flammability: Outer wall flame retardant
- Mil Spec: AMS-DTL-23053/4 Class 3
- Temperature range: -67°F to 230°F (-55°C to 110°C)
- For damp locations
- Material: Adhesive lined black cross-linked Polyolefin



D1. Terminals

D2. Power Connectors

D3. Grounding Connectors

E1. Labeling Systems

E2. Labels

E3. Pre-Printed & Write-On Markers

E4. Permanent Identification

E5. Lockout/Tagout & Safety Solutions

F. Index

Part Number	Nominal Diameter		Min. Expanded I.D.		Max. Recovered I.D.		Nominal Recovered Wall Thickness		Std. Pkg. Qty.	Std. Ctn. Qty.
	In.	mm	In.	mm	In.	mm	In.	mm		
4' pieces										
HSTTA19-48-Q	.187	4.8	.187	4.8	.062	1.6	.040	1.0	25	—
HSTTA25-48-Q	.250	6.4	.250	6.4	.080	2.0	.040	1.0	25	—
HSTTA25-48-TL	.250	6.4	.250	6.4	.080	2.0	.040	1.0	250	—
HSTTA38-48-Q	.375	9.5	.375	9.5	.120	3.0	.055	1.4	25	—
HSTTA38-48-TL	.375	9.5	.375	9.5	.120	3.0	.055	1.4	250	—
HSTTA50-48-5	.500	12.7	.500	12.7	.160	4.1	.070	1.8	5	—
HSTTA50-48-T	.500	12.7	.500	12.7	.160	4.1	.070	1.8	200	—
HSTTA75-48-5	.750	19.0	.750	19.0	.250	6.4	.085	2.2	5	—
HSTTA75-48-C	.750	19.0	.750	19.0	.250	6.4	.085	2.2	100	—
HSTTA100-48-5	1.00	25.4	1.00	25.4	.320	8.1	.100	2.5	5	—
HSTTA100-48-L	1.00	25.4	1.00	25.4	.320	8.1	.100	2.5	50	—
HSTTA150-48-5	1.50	38.1	1.50	38.1	.510	12.9	.100	2.5	5	—
HSTTA150-48-Q	1.50	38.1	1.50	38.1	.510	12.9	.100	2.5	25	—

Standard Packs of HSTTA Heat Shrink – 6" (152.44mm) Pieces

HSTTA19-Y	.187	4.8	.187	4.8	.062	1.6	.040	1.0	1	10
HSTTA25-Y	.250	6.4	.250	6.4	.080	2.0	.040	1.0	1	10
HSTTA38-Y	.375	9.5	.375	9.5	.120	3.0	.055	1.4	1	10
HSTTA50-Y	.500	12.7	.500	12.7	.160	4.1	.070	1.8	1	10
HSTTA75-Y	.750	19.0	.750	19.0	.250	6.4	.085	2.2	1	10
HSTTA100-Y	1.00	25.4	1.00	25.4	.320	8.1	.100	2.5	1	10
HSTTA150-Y	1.50	38.1	1.50	38.1	.510	12.9	.100	2.5	1	10

HSTTRA Heat Shrink 4 Foot Pieces

- Applications include insulating, protecting, and color coding wires and cables
- Semi-rigid tubing with an adhesive inner wall seals and protects components from moisture and corrosion
- Voltage rating: 600 V

- Shrink ratio: 2.5:1
- Mil Spec: AMS-DTL-23053/4 Class 1
- Temperature range: -67°F to 230°F (-55°C to 110°C)
- For damp locations
- Material: Adhesive lined black cross-linked Polyolefin



Part Number	Nominal Diameter		Min. Expanded I.D.		Max. Recovered I.D.		Nominal Recovered Wall Thickness		Std. Pkg. Qty.
	In.	mm	In.	mm	In.	mm	In.	mm	
HSTTRA12-48-Q	.125	3.2	.125	3.2	.023	0.6	.038	1.0	25
HSTTRA19-48-Q	.187	4.8	.187	4.8	.060	1.5	.043	1.1	25
HSTTRA25-48-Q	.250	6.4	.250	6.4	.080	2.0	.047	1.2	25
HSTTRA38-48-Q	.375	9.5	.375	9.5	.135	3.4	.050	1.3	25
HSTTRA50-48-5	.500	12.7	.500	12.7	.195	5.0	.059	1.5	5
HSTTRA100-48-5	1.00	25.4	1.00	25.4	.400	10.6	.075	1.9	5

UL SF Thick Wall Polyolefin Heat Shrink

- Applications include insulating, protecting, and color coding wires and cables
- Adhesive-lined inner wall seals and protects against moisture
- Thick wall suitable for direct burial according to UL 486D and provides excellent protection
- Voltage rating: UL 486D Listed for 600 V 1 kV 90°C continuous use
- Shrink ratio: 3:1

- Flammability: Flame retardant outer wall meets UL 224 VW-1
- UL Listed (Except HST3.0), CSA Certified
- Mil Spec: AMS-DTL-23053/15
- Temperature range: -85°F to 230°F (-65°C to 110°C)
- For wet locations
- Material: Adhesive lined black cross-linked Polyolefin



Part Number	Min. Expanded I.D.		Max. Recovered I.D.		Nominal Recovered Wall Thickness		Copper Conductor Size Range		Min. Cable O.D.		Max. Connector O.D.		Length		Std. Pkg. Qty.	Std. Ctn. Qty.
	In.	mm	In.	mm	In.	mm	AWG/MCM	mm ²	In.	mm	In.	mm	In.	mm		
HST0.4-3-Q	.40	10.1	.15	3.8	.090	2.3	#12 – #6 AWG	4 – 10	.170	4.3	.350	8.9	3.00	76.2	25	100
HST0.4-6-3	.40	10.1	.15	3.8	.090	2.3	#12 – #6 AWG	4 – 10	.170	4.3	.350	8.9	6.00	152.4	3	30
HST0.4-6-X	.40	10.1	.15	3.8	.090	2.3	#12 – #6 AWG	4 – 10	.170	4.3	.350	8.9	6.00	152.4	10	100
HST0.4-48-5	.40	10.1	.15	3.8	.090	2.3	#12 – #6 AWG	4 – 10	.170	4.3	.350	8.9	48.00	1200.0	5	20

Table continues on page C3.36

A. System Overview

B1. Cable Ties

B2. Cable Accessories

B3. Stainless Steel Ties

C1. Wiring Duct

C2. Surface Raceway

C3. Abrasion Protection

C4. Cable Management

D1. Terminals

D2. Power Connectors

D3. Grounding Connectors

E1. Labeling Systems

E2. Labels

E3. Pre-Printed & Write-On Markers

E4. Permanent Identification

E5. Lockout/Tagout & Safety Solutions

F. Index

A.
System
Overview

Thick Wall Polyolefin Heat Shrink (continued)

B1.
Cable Ties

B2.
Cable
Accessories

B3.
Stainless
Steel Ties

C1.
Wiring
Duct

C2.
Surface
Raceway

C3.
Abrasion
Protection

C4.
Cable
Management

D1.
Terminals

D2.
Power
Connectors

D3.
Grounding
Connectors

E1.
Labeling
Systems

E2.
Labels

E3.
Pre-Printed
& Write-On
Markers

E4.
Permanent
Identification

E5.
Lockout/
Tagout/
& Safety
Solutions

F.
Index

Part Number	Min. Expanded I.D.		Max. Recovered I.D.		Nominal Recovered Wall Thickness		Copper Conductor Size Range		Min. Cable O.D.		Max. Connector O.D.		Length		Std. Pkg. Qty.	Std. Ctn. Qty.
	In.	mm	In.	mm	In.	mm	AWG/MCM	mm ²	In.	mm	In.	mm	In.	mm		
HST0.8-6-3	.80	20.3	.26	6.4	.110	2.8	#8 – #1/0 AWG	10 – 50	.240	6.1	.650	16.5	6.00	152.4	3	30
HST0.8-6-X	.80	20.3	.26	6.4	.110	2.8	#8 – #1/0 AWG	10 – 50	.240	6.1	.650	16.5	6.00	152.4	10	100
HST0.8-9-X	.80	20.3	.26	6.4	.110	2.8	#8 – #1/0 AWG	10 – 50	.240	6.1	.650	16.5	9.00	228.6	10	100
HST0.8-12-5	.80	20.3	.26	6.4	.110	2.8	#8 – #1/0 AWG	10 – 50	.240	6.1	.650	16.5	12.00	304.8	5	50
HST0.8-48-5	.80	20.3	.26	6.4	.110	2.8	#8 – #1/0 AWG	10 – 50	.240	6.1	.650	16.5	48.00	1200.0	5	20
HST1.1-6-3	1.10	27.9	.37	9.4	.120	3.0	#2 – #4/0 AWG	35 – 95	.400	10.1	.875	22.2	6.00	152.4	3	30
HST1.1-6-X	1.10	27.9	.37	9.4	.120	3.0	#2 – #4/0 AWG	35 – 95	.400	10.1	.875	22.2	6.00	152.4	10	100
HST1.1-9-2	1.10	27.9	.37	9.4	.120	3.0	#2 – #4/0 AWG	35 – 95	.400	10.1	.875	22.2	9.00	228.6	2	20
HST1.1-9-X	1.10	27.9	.37	9.4	.120	3.0	#2 – #4/0 AWG	35 – 95	.400	10.1	.875	22.2	9.00	228.6	10	100
HST1.1-12-5	1.10	27.9	.37	9.4	.120	3.0	#2 – #4/0 AWG	35 – 95	.400	10.1	.875	22.2	12.00	304.8	5	50
HST1.1-48-5	1.10	27.9	.37	9.4	.120	3.0	#2 – #4/0 AWG	35 – 95	.400	10.1	.875	22.2	48.00	1200.0	5	20
HST1.5-9-X	1.50	38.1	.50	12.7	.170	4.3	#3/0 – #400 MCM	95 – 185	.600	15.2	1.190	30.2	9.00	228.6	10	100
HST1.5-12-1	1.50	38.1	.50	12.7	.170	4.3	#3/0 – #400 MCM	95 – 185	.600	15.2	1.190	30.2	12.00	304.8	1	10
HST1.5-12-5	1.50	38.1	.50	12.7	.170	4.3	#3/0 – #400 MCM	95 – 185	.600	15.2	1.190	30.2	12.00	304.8	5	50
HST1.5-48-5	1.50	38.1	.50	12.7	.170	4.3	#250 – #750 MCM	240 – 500	.600	15.2	1.190	30.2	48.00	1200.0	5	15
HST2.0-9-5	2.00	50.8	.67	16.9	.170	4.3	#250 – #750 MCM	240 – 500	.750	19.1	1.600	40.6	9.00	228.6	5	50
HST2.0-12-2	2.00	50.8	.67	16.9	.170	4.3	#250 – #750 MCM	240 – 500	.750	19.1	1.600	40.6	12.00	304.8	2	20
HST2.0-48-2	2.00	50.8	.67	16.9	.170	4.3	#600 – #1250 MCM	300 – 625	.75	19.1	1.600	40.6	48.00	1200.0	2	8
HST3.0-12-2	3.00	76.2	1.00	25.4	.170	4.3	#600 – #1250 MCM	300 – 625	1.200	30.5	2.250	57.2	12.00	304.8	2	20
HST3.0-48-2	3.00	76.2	1.00	25.4	.170	4.3	#600 – #1250 MCM	300 – 625	1.20	30.5	2.250	57.2	48.00	1200.0	2	8

Heat Shrink End Caps

- Applications include insulating, protecting, and color coding wires and cables
- Adhesive lined inner wall seals and provides excellent protection against moisture
- Voltage rating of 600 V
- Shrink ratio: 3:1
- Temperature range: -67°F to 230°F (-55°C to 110°C)
- For wet locations
- Material: Adhesive lined black cross-linked Polyolefin



Part Number	Min. Expanded I.D.		Max. Recovered I.D.		Nominal Recovered Wall Thickness		Copper Conductor Size Range	Cap Length		Std. Pkg. Qty.	Std. Ctn. Qty.
	In.	mm	In.	mm.	In.	mm		In.	mm		
HSEC0.5-X	.47	11.9	.18	4.6	.100	2.5	#8 – #4 AWG	1.4	35.1	10	100
HSEC0.8-X	.79	20.1	.30	7.6	.100	2.5	#4 – #3/0 AWG	2.1	54.1	10	100
HSEC1.0-X	1.02	25.9	.45	11.4	.100	2.5	#2 – #4/0 AWG	3.2	82.0	10	100
HSEC1.5-5	1.58	40.1	.68	17.3	.110	2.8	#250 – #500 MCM	3.8	98.0	5	50
HSEC2.0-5	2.25	57.2	.87	22.1	.150	3.8	#600 – #1000 MCM	5.5	140.2	5	50
HSEC4.0-2	4.14	105.2	1.78	45.2	.150	3.8	#1500 – #2000 MCM	6.9	175.3	2	10
HSECFR0.5-X	.51	13.0	.16	4.1	.090	2.4	#8 – #6 AWG	3.00	76.2	10	100
HSECFR0.8-X	.75	19.0	.24	6.1	.090	2.4	#6 – #2 AWG	3.50	88.9	10	100
HSECFR1.0-X	1.10	27.9	.35	8.9	.120	3.0	#1 – #3/0 MCM	4.00	101.6	10	100
HSECFR1.5-5	1.50	38.1	.47	11.9	.160	4.1	#2/0 – #350 MCM	4.50	114.3	5	50
HSECFR2.0-5	2.00	50.8	.63	16.0	.160	4.1	#250 – #500 MCM	4.50	114.3	5	50

A. System Overview

B1. Cable Ties

B2. Cable Accessories

B3. Stainless Steel Ties

C1. Wiring Duct

C2. Surface Raceway

C3. Abrasion Protection

C4. Cable Management

D1. Terminals

D2. Power Connectors

D3. Grounding Connectors

E1. Labeling Systems

E2. Labels

E3. Pre-Printed & Write-On Markers

E4. Permanent Identification

E5. Lockout/ Tagout & Safety Solutions

F. Index

A.
System
Overview

Plastic Heat Shrink Tubing Kit Boxes – For Dry Locations

B1.
Cable Ties



B2.
Cable
Accessories

B3.
Stainless
Steel Ties

Part Number	Part Description	Contents	Std. Pkg. Qty.
KP-HSTT1	Heat shrink kit box – plastic case, various sizes. black only.	35 ea. of 3/32", 1/8" 21 ea. of 3/16", 1/4" 7 ea. of 3/8", 1/2"	1
KP-HSTT2	Heat shrink kit box – plastic case, various sizes, various colors.	35 ea. (5 ea. color) 3/32", 1/8" 21 ea. (3 ea. color) 3/16", 1/4" 7 ea. (1 ea. color) 3/8", 1/2"	1
KP-HSTTA	Dual Wall Adhesive Lined Thin Wall Heat Shrink: Plastic Kit Box – Black only	14 ea. 3/16" 12 ea. 1/4" 10 ea. 3/8" 6 ea. 1/2" 3 ea. 3/4" 2 ea. 1"	1

C1.
Wiring
Duct

C2.
Surface
Raceway

C3.
Abrasion
Protection



Heat Shrink Tools and Accessories

C4.
Cable
Management



D1.
Terminals

D2.
Power
Connectors

D3.
Grounding
Connectors

E1.
Labeling
Systems

E2.
Labels

E3.
Pre-Printed
& Write-On
Markers

E4.
Permanent
Identification

E5.
Lockout/
Tagout/
& Safety
Solutions

F.
Index

Part Number	Part Description	Std. Pkg. Qty.	Std. Ctn. Qty.
HSG-115V-650	Heat gun with temperature range of 650°F (344°C) to 900°F (482°C).	1	—
HSG-A1	Shrink tube reflector for tubing up to 3/4" inside diameter. Directs heat around tubing to reduce shrink time.	1	10
HSG-A2	Shrink tube reflector for tubing up to 1 1/2" inside diameter. Directs heat around tubing to reduce shrink time.	1	10
HSG-A3	Shrink tube concentrator. Directs heat toward tubing and away from heat sensitive items.	1	10
HSG-A4	Black polyethylene case stores heat gun, stand, and all three accessories.	1	—
HSG-P1	Replacement brush/spring kit.	1	5
HSG-P2	Replacement switch 20 A.	1	5
HSG-P3	Replacement bearing kit.	1	5
HSG-P7	Replacement heat element 650°F.	1	—

Heat Shrink Installation Instructions

General Instructions

Position heat shrink over the object to be covered. Using a heat gun, soft yellow flame torch, infrared heat source or oven, evenly heat the tubing until it has fully recovered and conforms to the object. Use caution not to char or burn the tubing.

Special Instructions for HSTTT

TFE Heat Shrink is the most difficult to recover due to its high shrink temperature. TFE shrink tubing must be heated to the gel state 621°F (327°C) to completely recover. This can be recognized when the tubing changes from milky white to clear. Because of the unique characteristics of this material, a controlled temperature oven will achieve the most reliable results – it is difficult to consistently recover this product using a high-temp heat gun or similar heat source. These methods have a tendency to overheat the tube in one area while other areas remain cool.

When recovering onto objects, use a temperature controlled oven set at 660°F – 680°F (349°C – 360°C) for approximately 10 minutes is recommended. It is best to place the product on a fiberglass mat or suspend as opposed to contacting the oven rack. Do NOT heat the product above 700°F (371°C), or degradation damage to the TFE polymer will occur.

Size Selection for Heat Shrink Tubing

Generally, the largest tube that shrinks down tightly onto an object should be chosen. This allows the heat shrink tubing maximum stress relief and this will yield the longest service life.

Example:

A multi-conductor cable needs to be covered with HSTT Type *DRY-SHRINK™* Heat Shrink. The area to be covered has a measured outside diameter of .700" (17.8mm). The two possibilities are HSTT75-48-5 and HSTT100-48-5.

Part Number	Expanded I.D. In. (mm)	Recovered I.D. In. (mm)
HSTT75-48-5	.750 (19.0)	.375 (9.5)
HSTT100-48-5	1.00 (25.4)	.500 (12.7)

The proper choice is HSTT100-48-5 since the tube will recover more than HSTT75-48-5. The HSTT75-48-5 will fit over the .700 inch (17.8mm) outside diameter; however, this is not the proper choice since it is smaller than the HSTT100-48-5. In general, heat shrink should recover at least 10% – 20% to reduce stress and yield the longest service life.

A.
System
Overview

B1.
Cable Ties

B2.
Cable
Accessories

B3.
Stainless
Steel Ties

C1.
Wiring
Duct

C2.
Surface
Raceway

C3.
Abrasion
Protection

C4.
Cable
Management

D1.
Terminals

D2.
Power
Connectors

D3.
Grounding
Connectors

E1.
Labeling
Systems

E2.
Labels

E3.
Pre-Printed
& Write-On
Markers

E4.
Permanent
Identification

E5.
Lockout/
Tagout/
& Safety
Solutions

F.
Index

A. System Overview

Recommended Tubing Size for Common Wire Types Based on Location For Insulated Wire, Non-Insulated Wire, and Insulated Wire with Copper Connectors

B1. Cable Ties

Instructions for Tube Selection:

1) Determine location type.

B2. Cable Accessories

LOCATION:

DRY – IP62: A location not normally subject to dampness or wetness. A location classified as dry may be temporarily subject to dampness or wetness, as in the case of a building under construction.

B3. Stainless Steel Ties

DAMP – IP66: Partially protected locations under canopies, marquees, roofed open porches and like locations, and interior locations subject to moderate degrees of moisture, such as some basements, barns, and cold-storage warehouses.

WET – IP68: Installations underground or in concrete slabs or masonry in direct contact with the earth, and locations subject to saturation with water or other liquids, such as vehicle washing areas, and locations exposed to weather and unprotected.

C1. Wiring Duct

2) Match wire size to location type under required application – insulated wire, non-insulated wire, or insulated wire with copper connectors.

3) Read corresponding part number.

C2. Surface Raceway

4) Part numbers with “-Y” are packages containing 6 inch pieces. Part numbers with “-48” are 48 inch pieces.

5) Part numbers shown below are for black heat shrink.

C3. Abrasion Protection

Wire Size	Insulated Wire			Uninsulated Wire			Insulated Wire with Copper Connector		
	DRY-SHRINK™	DAMP-SHRINK™	WET-SHRINK™	DRY-SHRINK™	DAMP-SHRINK™	WET-SHRINK™	DRY-SHRINK™	DAMP-SHRINK™	WET-SHRINK™
24	HSTT12-Y	HSTTA19-Y	—	—	—	—	HSTT12-Y	—	—
22	HSTT12-Y	HSTTA19-Y	—	—	—	—	HSTT12-Y	—	—
20	HSTT12-Y	HSTTA19-Y	—	HSTT06-Y	—	—	HSTT19-Y	HSTTA19-Y	—
18	HSTT19-Y	HSTTA19-Y	—	HSTT06-Y	—	—	HSTT19-Y	HSTTA19-Y	—
16	HSTT19-Y	HSTTA25-Y	—	HSTT06-Y	—	—	HSTT19-Y	HSTTA25-Y	—
14	HSTT19-Y	HSTTA25-Y	—	HSTT12-Y	HSTTA19-Y	—	HSTT19-Y	HSTTA25-Y	—
12	HSTT25-Y	HSTTA38-Y	HST0.4-48-5	HSTT12-Y	HSTTA19-Y	—	HSTT25-Y	HSTTA38-Y	HST0.4-48-5
10	HSTT25-Y	HSTTA38-Y	HST0.4-48-5	HSTT19-Y	HSTTA25-Y	—	HSTT25-Y	HSTTA38-Y	HST0.4-48-5
8	HSTT38-Y	HSTTA50-Y	HST0.4-48-5	HSTT25-Y	HSTTA25-Y	—	HSTT38-Y	HSTTA50-Y	HST0.4-48-5
6	HSTT50-Y	HSTTA50-Y	HST0.8-48-5	HSTT25-Y	HSTTA38-Y	HST0.4-48-5	HSTT50-Y	HSTTA50-Y	HST0.8-48-5
4	HSTT50-Y	HSTTA75-Y	HST0.8-48-5	HSTT38-Y	HSTTA38-Y	HST0.4-48-5	HSTT50-Y	HSTTA75-Y	HST0.8-48-5
3	HSTT50-Y	HSTTA75-Y	HST0.8-48-5	HSTT38-Y	HSTTA50-Y	HST0.4-48-5	HSTT50-Y	HSTTA75-Y	HST0.8-48-5
2	HSTT75-Y	HSTTA100-Y	HST0.8-48-5	HSTT50-Y	HSTTA50-Y	HST0.8-48-5	HSTT75-Y	HSTTA100-Y	HST0.8-48-5
1	HSTT75-Y	HSTTA100-Y	HST0.8-48-5	HSTT50-Y	HSTTA50-Y	HST0.8-48-5	HSTT75-Y	HSTTA100-Y	HST1.1-48-5
1/0	HSTT75-Y	HSTTA100-Y	HST1.1-48-5	HSTT50-Y	HSTTA75-Y	HST0.8-48-5	HSTT75-Y	HSTTA100-Y	HST1.1-48-5
2/0	HSTT100-Y	HSTTA100-Y	HST1.1-48-5	HSTT50-Y	HSTTA75-Y	HST0.8-48-5	HSTT100-Y	HSTTA100-Y	HST1.1-48-5
3/0	HSTT100-Y	HSTTA150-Y	HST1.1-48-5	HSTT75-Y	HSTTA100-Y	HST0.8-48-5	HSTT100-Y	HSTTA150-Y	HST1.5-48-5
4/0	HSTT100-Y	HSTTA150-Y	HST1.5-48-5	HSTT75-Y	HSTTA100-Y	HST1.1-48-5	HSTT100-Y	HSTTA150-Y	HST1.5-48-5
250	HSTT100-Y	HSTTA150-Y	HST1.5-48-5	HSTT100-Y	HSTTA100-Y	HST1.1-48-5	HSTT100-Y	HSTTA150-Y	HST1.5-48-5
300	HSTT150-48-5	HSTTA150-Y	HST1.5-48-5	HSTT100-Y	HSTTA100-Y	HST1.1-48-5	HSTT100-Y	HSTTA150-Y	HST1.5-48-5
350	HSTT150-48-5	HSTTA150-Y	HST1.5-48-5	HSTT100-Y	HSTTA150-Y	HST1.5-48-5	HSTT150-48-5	HSTTA150-Y	HST2.0-48-2
400	HSTT150-48-5	HSTTA150-Y	HST2.0-48-2	HSTT100-Y	HSTTA150-Y	HST1.5-48-5	HSTT150-48-5	HSTTA150-Y	HST2.0-48-2
500	HSTT150-48-5	HSTTA150-Y	HST2.0-48-2	HSTT100-Y	HSTTA150-Y	HST1.5-48-5	HSTT150-48-5	HSTTA150-Y	HST2.0-48-2
600	HSTT150-48-5	HSTTA150-Y	HST2.0-48-2	HSTT150-48-5	HSTTA150-Y	HST2.0-48-2	HSTT150-48-5	HSTTA150-Y	HST2.0-48-2
700	HSTT200-48-5	HSTTA150-Y	HST2.0-48-2	HSTT150-48-5	HSTTA150-Y	HST2.0-48-2	HSTT200-48-5	—	HST2.0-48-2
750	HSTT200-48-5	HSTTA150-Y	HST3.0-48-2	HSTT150-48-5	HSTTA150-Y	HST2.0-48-2	HSTT200-48-5	—	HST3.0-48-2
800	HSTT200-48-5	—	HST3.0-48-2	HSTT150-48-5	HSTTA150-Y	HST2.0-48-2	HSTT200-48-5	—	HST3.0-48-2
900	HSTT200-48-5	—	HST3.0-48-2	HSTT150-48-5	HSTTA150-Y	HST2.0-48-2	HSTT200-48-5	—	HST3.0-48-2
1000	HSTT200-48-5	—	HST3.0-48-2	HSTT200-48-5	HSTTA150-Y	HST2.0-48-2	HSTT200-48-5	—	HST3.0-48-2
1250	HSTT300-48-2	—	HST3.0-48-2	HSTT200-48-5	HSTTA150-Y	HST2.0-48-2	—	—	HST3.0-48-2
1500	HSTT300-48-2	—	HST3.0-48-2	HSTT200-48-5	—	HST3.0-48-2	—	—	—
1750	HSTT300-48-2	—	HST3.0-48-2	HSTT200-48-5	—	HST3.0-48-2	—	—	—
2000	HSTT300-48-2	—	HST3.0-48-2	HSTT200-48-5	—	HST3.0-48-2	—	—	—

C4. Cable Management

D1. Terminals

D2. Power Connectors

D3. Grounding Connectors

E1. Labeling Systems

E2. Labels

E3. Pre-Printed & Write-On Markers

E4. Permanent Identification

E5. Lockout/Tagout & Safety Solutions

F. Index

Sizing information is based on the following wire types: MTW, THHN, THWN, TFN, THW, TW, TF, RHW, RH, RHH and UL 1015.

THHN is the most common wire type.

Portions reprinted with permission from NFPA, the National Electrical Code* Handbook, Copyright 1996, National Fire Protection Association, Quincy, MA 02269.

*All rights reserved. National Electrical Code and NEC are registered trademarks of the National Fire Protection Association, Inc., Quincy, MA 02269.

IP (Ingress Protection) as defined by the International Standard IEC 529

The IEC 529 international standard describes a system for classifying the degrees of protection provided by the enclosures of electrical equipment and is a recognized standard around the world. An independent test laboratory has tested *PANDUIT* Heat Shrink Tubing to the IEC 529 standard. The following information exhibits the IP ratings for *PANDUIT* heat shrink tubing and how each of the IP ratings relates to the USA.

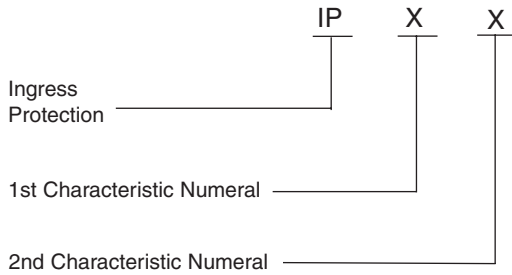



The first characteristic numeral indicates the level of protection against the ingress of solid foreign objects.

The second characteristic numeral indicates the level of protection against the ingress of water.

1st Characteristic Numeral	
Ingress Protection (IP)	Meaning for Protection
Against ingress of solid object	
0	Non-Protected
1	50mm diameter
2	12.5mm diameter
3	2.5mm diameter
4	1.0mm diameter
5	Dust Protected
<i>DRY-SHRINK™</i> , <i>DAMP-SHRINK™</i> and <i>WET-SHRINK™</i> Heat Shrink Tubing	Dust Tight

2nd Characteristic Numeral		
<i>PANDUIT</i> Heat Shrink	Ingress Protection (IP)	Meaning for Protection
	Against ingress of water	
	0	Non-Protected
	1	Vertically Dripping
<i>DRY-SHRINK™</i> Heat Shrink Tubing	2	Dripping (15° tilted)
	3	Spraying
	4	Splashing
	5	Jetting
<i>DAMP-SHRINK™</i> Heat Shrink Tubing	6	Powerful Jetting
	7	Temporary Immersion
<i>WET-SHRINK™</i> Heat Shrink Tubing	8	Continuous Immersion

	Intended Application Location	Ingress Protection Rating	Description
	DRY locations not normally subject to moisture	IP62	Protected against the ingress of dust but not protected against the ingress of water
	DAMP locations subjected to moderate degrees of water and moisture	IP66	Protected against the ingress of dust and protected against the ingress of power jet of water
	WET locations are defined as underground burial or immersion in water	IP68	Protected against the ingress of dust and protected against the ingress of water to a depth of 10m

DRY-SHRINK™ Heat Shrink has been tested in accordance with EN 60529 paragraph 13.4 thereby providing *PANDUIT DRY-SHRINK™* Heat Shrink with an ingress protection rating of IP62.

DAMP-SHRINK™ Heat Shrink has been tested in accordance with EN 60529 paragraph 13.4 and with paragraph 14.2.6 thereby providing *PANDUIT® DAMP-SHRINK™* with an ingress protection rating of IP66.

WET-SHRINK™ Heat Shrink has been tested in accordance with EN 60529 paragraph 13.4, paragraph 14.2.6 and with paragraph 14.2.7 thereby providing *WET-SHRINK™* Heat Shrink with an ingress protection rating of IP68. *PANDUIT® WET-SHRINK™* Heat Shrink has passed EN 60529 paragraph 14.2.7 at depth of 10m.

A. System Overview

B1. Cable Ties

B2. Cable Accessories

B3. Stainless Steel Ties

C1. Wiring Duct

C2. Surface Raceway

C3. Abrasion Protection

C4. Cable Management

D1. Terminals

D2. Power Connectors

D3. Grounding Connectors

E1. Labeling Systems

E2. Labels

E3. Pre-Printed & Write-On Markers

E4. Permanent Identification

E5. Lockout/Tagout & Safety Solutions

F. Index

A. System Overview

DRY-SHRINK™, DAMP-SHRINK™, and WET-SHRINK™ Heat Shrink Tubing

B1. Cable Ties

Technical Data

General Information

Product Type	Typical Applications	Specific Gravity	Flammability	Water Absorption	Dielectric Strength
HSTT	Economical and easy way to insulate, protect, harness and identify electrical and electronic components in a wide variety of applications. Black is U.V. Resistant.	Class 1, 1.35 Class 2, 1.0 ASTM D792	Class 1 Self Extinguishing Class 2 N/A ASTM D2671 Procedure B	.5% MAX. ASTM D570	500 V/MIL. (19.7 Kv/mm) min. ASTM D2671
HSTTV	Use where UL recognition with VW-1 rating is required. Use where the wire component cannot tolerate higher shrink temperatures, reduces application time to insulate, protect, identify, etc. Black is U.V. Resistant.	1.50 ASTM D792	VW-1 per UL 224	.5% MAX. ASTM D570	500 V/MIL. (19.7 Kv/mm) min. ASTM D2671
HSTTP	Ripple free conformance around sharp bends as in appliance handles and bus bars. Good cut through and solder-iron resistance. Black is U.V. Resistant.	1.35 MAX.	VW-1 per UL 224	1.0% MAX. ASTM D570	400 V/MIL. (15.8 Kv/mm) min. ASTM D2671
HSTTPN	Crystal clear product that is excellent for protecting wire and cable markers and continuous inspection of splices	N/A	UL 224 VW-1	1.0% MAX. ASTM D570	400 V/MIL. (15.8 Kv/mm) min. ASTM D2671
HSTTN	Insulation and abrasion resistance, extensive military uses on vehicles and ship-board. Excellent chemical resistance especially to fuels and oils. Black is U.V. Resistant.	1.30 ASTM D792	Self Extinguishing ASTM D876	1.0% MAX. ASTM D570	300 V/MIL. (11.8 Kv/mm) min. ASTM D2671
HSTTT	High insulation and abrasion resistance. High temperature, strain relief, resists corrosive atmosphere, self lubrication and non-wetting. Can be used with fiber optics and as a strain relief for high density connectors. U.V. Resistant	2.2 MAX. ASTM D792	VW-1 per UL 224	.01% MAX. ASTM D570	800 V/MIL. (31.5 Kv/mm) min. ASTM D2671
HSTTK	Protection and strain relief for wires or connectors in a high temperature or solvent rich environment. Insulation of heater leads.	1.8 MAX. ASTM D792	VW-1 per UL 224	.5% MAX. ASTM D570	Size to (12.7mm) 800 V/MIL. (31.5 Kv/mm) min Over (12.7mm) 600 V/MIL. (23.6 Kv/mm) min ASTM D2671
HSTTVA	Seals and protects components from moisture and corrosion. Use where a flexible tubing is needed. Suitable for damp locations.	N/A	Self Extinguishing ASTM D2671 Procedure B	.5% MAX. ASTM D570	500 V/MIL. (19.7 Kv/mm) min. ASTM D2671
HSTTA	Environmentally seals and protects components. The 3:1 shrink ratio is a benefit when working with connector to cable transitions. Suitable for damp locations.	N/A	Self Extinguishing ASTM D2671 Procedure B	1.0% MAX.ASTM D570	300 V/MIL. (11.8 Kv/mm) min. ASTM D2671
HSTTRA	Environmentally seals and protects components forming a rugged and heavy duty covering. The 2.5:1 shrink ratio is a benefit when working with connector to cable transitions. Suitable for damp locations.	N/A	N/A	.5% MAX. ASTM D570	500 V/MIL. (19.7 Kv/mm) min. ASTM D2671
HST	Seals and protects electrical connections and splices above or below ground, 3:1 shrink ratio. Suitable for outdoor and wet locations.	1.2 MAX.	Self Extinguishing ASTM D2671 Procedure C	.5% MAX. ASTM D570	200 V/MIL. (7.9 Kv/mm) min. ASTM D2671

E4. Permanent Identification

E5. Lockout/Tagout & Safety Solutions

F. Index

CABLE MANAGEMENT

PANDUIT offers a complete line of cable management products and accessories to route and secure cable. These products are an essential part of a clean, professional installation, which help improve quality and increase system performance.



PANDUIT solutions provide the options necessary to handle the most demanding installations while providing the flexibility to facilitate system upgrades now and in the future.

- Maintains bend radius control and cable performance while bundling and securing cable to prevent snags and stress from over bending
- Provides attractive installations and allows for easier moves, adds, and changes while reducing stress on cable
- Organizes cable in a variety of applications where depth is critical or space is limited

A.
System
Overview

B1.
Cable Ties

B2.
Cable
Accessories

B3.
Stainless
Steel Ties

C1.
Wiring
Duct

C2.
Surface
Raceway

C3.
Abrasion
Protection

C4.
Cable
Management

D1.
Terminals

D2.
Power
Connectors

D3.
Grounding
Connectors

E1.
Labeling
Systems

E2.
Labels

E3.
Pre-Printed
& Write-On
Markers

E4.
Permanent
Identification

E5.
Lockout/
Tagout
& Safety
Solutions

F.
Index



COOL BOOT™ Raised Floor Assembly

A. System Overview

B1. Cable Ties

B2. Cable Accessories

B3. Stainless Steel Ties

C1. Wiring Duct

C2. Surface Raceway

C3. Abrasion Protection

C4. Cable Management

D1. Terminals

D2. Power Connectors

D3. Grounding Connectors

E1. Labeling Systems

E2. Labels

E3. Pre-Printed & Write-On Markers

E4. Permanent Identification

E5. Lockout/Tagout & Safety Solutions

F. Index

- Air tight fabric minimizes bypass of air through cutouts in the raised floor to decrease energy costs in hot aisle/cold aisle data center designs
- **ULTRA-CINCH™** Tie closes top of fabric to prevent air from escaping around cable bundles
- Electrostatic dissipative material provides a pathway to ground reducing the chance of damaging network equipment with electric shock
- Vertical **TAK-TY®** Hook & Loop Cable Tie closure system allows for installation on existing cable bundles
- Horizontal **TAK-TY®** Hook & Loop Cable Tie closure system allows two or more bundles to be separated in existing or new installations

- Flexible polycarbonate outer ring houses fabric to allow user to secure product to raised floor tile; slit allows outer ring to flex so entire cable bundle can be inserted to allow for retrofit installations even when vertical cable managers are already in place
- Low profile polycarbonate outer ring extends 7/16" above top of raised floor tile to allow compatibility with vertical cable managers.
- Self-tapping #10 screws (included) allow a secure fastening method to top of raised floor tile that also provides a pathway to ground
- Color: Black polycarbonate outer ring with navy blue fabric
- Manufactured from flame retardant material



RFG*X*SM

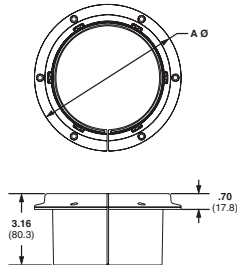
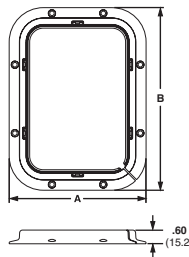

Part Number	Material	Length		Width		Diameter		Max. Bundle Diameter		Std. Pkg. Qty.	Std. Ctn. Qty.
		In.	mm	In.	mm	In.	mm	In.	mm		
Surface Mount											
RFG6X8SM	Polycarbonate outer ring with vinyl coated fabric	8.0	203.2	6.0	152.4	—	—	4.2 x 6.2	106.7 x 157.4	1	1
RFG8X8SM	Polycarbonate outer ring with vinyl coated fabric	8.0	203.2	8.0	203.2	—	—	6.2 x 6.2	157.4 x 157.4	1	1
RFG10X8SM	Flame Retardant Conductive Polycarbonate with a Conductive Fabric	8.0	203.2	10.0	254.0	—	—	8.2 x 6.2	208.3 x 157.4	1	1
RFG12X4SM	Flame Retardant Conductive Polycarbonate with a Conductive Fabric	4.0	101.6	12.0	304.8	—	—	10.2 x 2.2	259.1 x 55.9	1	1
RFG12X8SM	Flame Retardant Conductive Polycarbonate with a Conductive Fabric	8.0	203.2	12.0	304.8	—	—	10.2 x 6.2	259.1 x 157.4	1	1
RFG3DSM	Flame Retardant Conductive Polycarbonate with a Conductive Fabric	—	—	—	—	4.5	114.3	2.7	68.6	1	1
RFG5DSM	Flame Retardant Conductive Polycarbonate with a Conductive Fabric	—	—	—	—	6.5	165.1	4.7	119.4	1	1

Product complies with Article 645 Section 5(D)(4) of the 2005 National Electrical Code.
 Compatible with **NETRUNNER™** and **PATCHRUNNER™** Cable Managers, and **PANDUIT NET-ACCESS™** Cabinets to create a complete cable management system.
 *Integral products include a flexible sub-grommet to prevent damage to cable from sharp edges of cut floor tile.

COOL BOOT™ Raised Floor Assembly (continued)



RFG*X*

Part Number	Material	Length		Width		Diameter		Max. Bundle Diameter		Std. Pkg. Qty.	Std. Ctn. Qty.
		In.	mm	In.	mm	In.	mm	In.	mm		
Integral Mount*											
RFG6X8	Flame Retardant Conductive Polycarbonate with a Conductive Fabric	8.0	203.2	6.0	152.4	—	—	4.2 x 6.2	106.7 x 157.4	—	—
RFG8X8	Flame Retardant Conductive Polycarbonate with a Conductive Fabric	8.0	203.2	8.0	203.2	—	—	6.2 x 6.2	157.4 x 157.4	1	1
RFG10X8	Flame Retardant Conductive Polycarbonate with a Conductive Fabric	8.0	203.2	10.0	254.0	—	—	8.2 x 6.2	208.3 x 157.4	1	1
RFG12X4	Flame Retardant Conductive Polycarbonate with a Conductive Fabric	4.0	101.6	12.0	304.8	—	—	10.2 x 2.2	259.1 x 55.9	1	1
RFG12X8	Flame Retardant Conductive Polycarbonate with a Conductive Fabric	8.0	203.2	12.0	304.8	—	—	10.2 x 2.2	259.1 x 157.4	1	1
RFG3D	Flame Retardant Conductive Polycarbonate with a Conductive Fabric	—	—	—	—	4.5	114.3	3.0	68.6	1	1
RFG5D	Flame Retardant Conductive Polycarbonate with a Conductive Fabric and Thermoplastic Elastomer	—	—	—	—	6.5	165.1	4.7	119.4	1	1

Product complies with Article 645 Section 5(D)(4) of the 2005 National Electrical Code.

Compatible with *NETRUNNER™* and *PATCHRUNNER™* Cable Managers, and *PANDUIT NET-ACCESS™* Cabinets to create a complete cable management system.

*Integral products include a flexible sub-grommet to prevent damage to cable from sharp edges of cut floor tile.

A.
System
Overview

B1.
Cable Ties

B2.
Cable
Accessories

B3.
Stainless
Steel Ties

C1.
Wiring
Duct

C2.
Surface
Raceway

C3.
Abrasion
Protection

C4.
Cable
Management

D1.
Terminals

D2.
Power
Connectors

D3.
Grounding
Connectors

E1.
Labeling
Systems

E2.
Labels

E3.
Pre-Printed
& Write-On
Markers

E4.
Permanent
Identification

E5.
Lockout/
Tagout/
& Safety
Solutions

F.
Index

A. System Overview



J-PRO™ Cable Support System

B1. Cable Ties

B2. Cable Accessories

B3. Stainless Steel Ties

C1. Wiring Duct

C2. Surface Raceway

C3. Abrasion Protection

C4. Cable Management

D1. Terminals

D2. Power Connectors

D3. Grounding Connectors

E1. Labeling Systems

E2. Labels

E3. Pre-Printed & Write-On Markers

E4. Permanent Identification

E5. Lockout/Tagout & Safety Solutions

F. Index

- Patent pending design provides complete horizontal and vertical 1 inch bend radius control that helps prevent degradation of cable performance
- UL 2043 and CAN/ULC S102.2 approved and suitable for use in air handling spaces
- Pre-rieveted assemblies allow for attachment to walls, ceilings, beams, threaded rods, drop wires and underfloor supports to meet requirements of a variety of applications

- Wide cable support base prevents pinch points that could cause damage to cables
- Cable tie channel allows user to easily install 3/4" *TAK-TY*® Cable Ties to retain cable bundle
- Durable non-metallic J Hook materials provide the ability to manage and support a large number of cables



JP2W-L20



JP2WP-L20



JP2CM-L20



JP2DW-L20

Part Number*	Part Description	Max. Bundle Capacity		Max. Cable Capacity			Max. Static Load		Std. Pkg. Qty.
		In.	mm	Cat. 6A (.330")	Cat. 6 (.250")	Cat. 5e (.187")	Lbs.	kg.	
Wall Mount									
JP75W-L20‡	J Hook for wall mount applications. One 1/4" (M6) mounting hole for user supplied screw.	.75	19.0	2	11	15	15	6.81	50
JP131W-L20		1.31	33.3	9	26	32	20	9.07	50
JP2W-L20‡		2.00	50.8	23	50	64	30	13.6	50
JP4W-X20‡‡		4.00	101.6	103	225	250	100	45.37	10

Wall Mount with Bracket									
JP75WP-L20‡	J Hook for powder actuated installation on walls. One 5/32" (M4) mounting hole for user supplied fasteners.	.75	19.0	2	11	15	15	6.81	50
JP131WP-L20		1.31	33.3	9	26	32	20	9.07	50
JP2WP-L20‡		2.00	50.8	23	50	64	30	13.61	50
JP4WP-X20		4.00	101.6	103	225	250	100	45.37	10

Ceiling Mount									
JP75CM-L20‡	J Hook with ceiling mount bracket that has one 3/16" (M5), 1/4" (M6) and 3/8" (M10) mounting hole.	.75	19.0	2	11	15	15	6.81	50
JP131CM-L20		1.31	33.3	9	26	32	20	9.07	50
JP2CM-L20‡		2.00	50.8	23	50	64	30	13.61	50
JP4CM-X20		4.00	101.6	103	225	250	100	45.37	10

Drop Wire and Threaded Rod Clip									
JP75DW-L20‡	J Hook with clip for use with #12 wire, threaded rod up to 1/4" in diameter, or 1/8" - 1/4" thick flanges.	.75	19.0	2	11	15	10	4.53	50
JP131DW-L20		1.31	33.3	9	26	32	10	4.53	50
JP2DW-L20		2.00	50.8	23	50	64	10	4.53	50

*Suitable for use in air handling spaces in accordance with Sec. 300-22(c) and (d) of the National Electrical Code. JP4 family of parts suitable for use in single unit configurations. Listed in accordance with CAN/ULC S102.2 when mounted as single units or in pairs. Minimum spacing of 4' (1220mm) required between mount points. (Flame spread rating = 0, Smoke developed classification = 30)

‡Standard product is black in color. For red replace - L20 with - L2 in part number suffix.

‡‡Standard product is black in color. For red replace - X20 with - X2, for blue replace - X20 with - X6 in part number suffix.



J-PRO™ Cable Support System (continued)



JP2SBC50R-L20



JP2SBC50-L20



JP2SBC87-L20



JP2SBC87R-L20



JP2HBC25R-L20
JP2HBC50R-L20
JP2HBC75R-L20

Part Number*	Part Description	Max. Bundle Capacity		Max. Cable Capacity			Max. Static Load		Std. Pkg. Qty.
		In.	mm	Cat. 6A (.330")	Cat. 6 (.250")	Cat. 5e (.187")	Lbs.	kg.	
Screw-On Beam Clamps									
JP75SBC50-L20	J Hook with screw-on beam clamp for use with flanges up to 1/2" thick.	.75	19.0	2	11	15	15	6.81	50
JP131SBC50-L20		1.31	33.3	9	26	32	20	9.07	50
JP2SBC50-L20		2.00	50.8	23	50	64	30	13.61	50
JP4SBC50-X20		4.00	101.6	103	225	250	100	45.37	10
JP75SBC50R-L20‡	J Hook with screw-on beam clamp for use with flanges up to 1/2" thick. Rotates 360 degrees.	.75	19.0	2	11	15	15	6.81	50
JP131SBC50R-L20		1.31	33.3	9	26	32	20	9.07	50
JP2SBC50R-L20‡		2.00	50.8	23	50	64	30	13.61	50
JP4SBC50R-X20		4.00	101.6	103	225	250	100	45.37	10
JP75SBC87-L20	J Hook with screw-on beam clamp for use with flanges up to 3/4" thick.	.75	19.0	2	11	15	15	6.81	50
JP131SBC87-L20		1.31	33.3	9	26	32	20	9.07	50
JP2SBC87-L20		2.00	50.8	23	50	64	30	13.61	50
JP4SBC87-X20		4.00	101.6	103	225	250	100	45.37	10
JP75SBC87R-L20	J Hook with screw-on beam clamp for use with flanges up to 3/4" thick.	.75	19.0	2	11	15	15	6.81	50
JP131SBC87R-L20		1.31	33.3	9	26	32	20	9.07	50
JP2SBC87R-L20		2.00	50.8	23	50	64	30	13.61	50
JP4SBC87R-X20		4.00	101.6	103	225	250	100	45.37	10
Hammer-On Beam Clamps									
JP75HBC25R-L20	J Hook with hammer-on beam clamp for use with flanges 1/8" – 1/4" thick. Rotates 360 degrees.	.75	19.0	2	11	15	15	13.61	50
JP131HBC25R-L20		1.31	33.3	9	26	32	230	9.07	50
JP2HBC25R-L20		2.00	50.8	23	50	64	30	13.61	50
JP4HBC25R-X20		4.00	101.6	103	225	250	30	13.61	150
JP75HBC50R-L20	J Hook with hammer-on beam clamp for use with flanges 5/16" – 1/2" thick. Rotates 360 degrees.	.75	19.0	2	11	15	15	6.81	50
JP131HBC50R-L20		1.31	33.3	9	26	32	20	9.07	50
JP2HBC50R-L20		2.00	50.8	23	50	64	30	13.61	50
JP4HBC50R-X20		4.00	101.6	103	225	250	30	13.61	10
JP75HBC75R-L20	J Hook with hammer-on beam clamp for use with flanges 9/16" – 3/4" thick. Rotates 360 degrees.	.75	19.0	2	11	15	15	6.81	50
JP131HBC75R-L20		1.31	33.3	9	26	32	20	9.07	50
JP2HBC75R-L20		2.00	50.8	23	50	64	30	13.61	50
JP4HBC75R-X20		4.0	101.6	1.03	225	250	30	13.61	10

*Suitable for use in air handling spaces in accordance with Sec. 300-22(c) and (d) of the National Electrical Code. JP4 family of parts suitable for use in single unit configurations. Listed in accordance with CAN/ULC S102.2 when mounted as single units or in pairs. Minimum spacing of 4" (1220mm) required between mount points. (Flame spread rating = 0, Smoke developed classification = 30)

‡Standard product is black in color. For red replace – L20 with – L2 in part number suffix.

‡‡Standard product is black in color. For red replace – X20 with – X2, for blue replace – X20 with – X6 in part number suffix.

Table continues on page C4.6

A.
System
Overview

B1.
Cable Ties

B2.
Cable
Accessories

B3.
Stainless
Steel Ties

C1.
Wiring
Duct

C2.
Surface
Raceway

C3.
Abrasion
Protection

C4.
Cable
Management

D1.
Terminals

D2.
Power
Connectors

D3.
Grounding
Connectors

E1.
Labeling
Systems

E2.
Labels

E3.
Pre-Printed
& Write-On
Markers

E4.
Permanent
Identification

E5.
Lockout/
Tagout
& Safety
Solutions

F.
Index

A.
System
Overview



J-PRO™ Cable Support System (continued)

B1.
Cable Ties



JP2ZP-L20

B2.
Cable
Accessories

B3.
Stainless
Steel Ties



JP2CP-L20

C1.
Wiring
Duct

C2.
Surface
Raceway

C3.
Abrasion
Protection



JP2UF100-L20

C4.
Cable
Management

D1.
Terminals

D2.
Power
Connectors

D3.
Grounding
Connectors

E1.
Labeling
Systems

E2.
Labels

E3.
Pre-Printed
& Write-On
Markers

E4.
Permanent
Identification

E5.
Lockout/
Tagout/
& Safety
Solutions

F.
Index

Part Number*	Part Description	Max. Bundle Capacity		Max. Cable Capacity			Max. Static Load		Std. Pkg. Qty.
		In.	mm	Cat. 6A (.330")	Cat. 6 (.250")	Cat. 5e (.187")	Lbs.	kg.	
Z-Purlin Clips									
JP75ZP-L20	J Hook with z-purlin clip for use with angled flanges up to 1/4" thick.	.75	19.0	2	11	15	15	6.81	50
JP131ZP-L20		1.31	33.3	9	26	32	20	9.07	50
JP2ZP-L20		2.00	50.8	23	50	64	30	13.61	50
JP4ZP-X20		4.00	101.6	103	225	250	60	27.22	10
C-Purlin Clips									
JP75CP-L20	J Hook with c-purlin clip for use with vertical flanges up to 1/4" thick.	.75	19.0	2	11	15	15	6.81	50
JP131CP-L20		1.31	33.3	9	26	32	20	9.07	50
JP2CP-L20		2.00	50.8	23	50	64	30	13.61	50
JP4CP-X20		4.00	101.6	103	225	250	60	27.22	10
Underfloor Pedestal Support Clamp									
JP75UF100-L20	J Hook with underfloor pedestal support clamp for use with pedestal support up to 1" diameter.	.75	19.0	2	11	15	15	6.81	50
JP131UF100-L20		1.31	33.3	9	26	32	20	9.07	50
JP2UF100-L20		2.00	50.8	23	50	64	30	13.61	50
JP4UF100-X20		4.00	101.6	103	225	250	50	22.69	10

*Suitable for use in air handling spaces in accordance with Sec. 300-22(c) and (d) of the National Electrical Code. JP4 family of parts suitable for use in single unit configurations. Listed in accordance with CAN/ULC S102.2 when mounted as single units or in pairs. Minimum spacing of 4' (1220mm) required between mount points. (Flame spread rating = 0, Smoke developed classification = 30)

‡Standard product is black in color. For red replace – L20 with – L2 in part number suffix.

‡‡Standard product is black in color. For red replace – X20 with – X2, for blue replace – X20 with – X6 in part number suffix.



J-MOD® Cable Support System

- Modular design allows flexibility to assemble system in multiple configurations
- Unique chaining bracket design creates a strong metal backbone and allows expansion of the system without disturbance of an existing installation

- Brackets allow for attachment to ceilings, beams, threaded rods and drop wires to meet requirements of a variety of applications
- Manufactured from materials that meet UL 2043 and are suitable for use in air handling spaces
- Complete horizontal and vertical 1" bend radius control
- Cables do not come in contact with metal



JMJDW-X20

JMJDH-X20



JMJDH-X20

JMJDW-X20

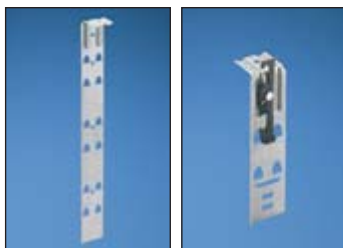

JMJDW-3-X

JMJDWB-1-X



JMJDWB-1-X

JMJDWB-3-X



JMJDWB-3-X

JMJDWB-1-X



JMJDWB-3-X

Part Number	Part Description	Material*	Max. Static Load		Std. Pkg. Qty.	Std. Ctn. Qty.
			Lbs.	Kg.		
J Hook with Maximum 2" Bundle Capacity						
JMJDW-X20*	J Hook for wall mount applications only. Two 1/4" (M6) mounting holes for user supplied screws.	Nylon 6.6	30	13.61	10	50
JMJDH-X20*	J Hook with snap lock attachments for use with all brackets listed below.	Nylon 6.6	30	13.61	10	50
Chaining Bracket						
JMJDH-X	Chaining bracket to extend J-MOD® capacity one level. Capacity: three levels maximum. For use with all single-level mounting brackets listed below.	Zinc Plated Steel	120	54.45	10	50
Ceiling Mount Brackets						
JMJDW-1-X	Single-level ceiling mount bracket with one 1/4" (M6) mounting hole.	Galvanized Steel	180	81.65	10	50
JMJDW-3-X**	Three-level ceiling mount bracket with one 1/4" (M6) mounting hole. Maximum capacity of six J Hooks.	Galvanized Steel	180	81.65	10	50
Drop Wire Brackets						
JMJDWB-1-X	Single-level drop wire bracket. Attaches to #12 wire or 1/4" plain rod. Maximum capacity of one J Hook per level.	Galvanized Steel with Metal Attachments	20	9.07	10	50
JMJDWB-3-X**	Three-level drop wire bracket. Attaches to #12 wire or 1/4" plain rod. Maximum capacity of one J Hook for each of three levels.	Galvanized Steel with Metal Attachments	40	18.14	10	50
Threaded Rod Brackets						
JMJDWB-1-X	Single-level threaded rod bracket. Accepts 1/4" – 3/8" threaded rod.	Galvanized Steel with Metal Attachments	180	81.65	10	50
JMJDWB-3-X**	Three-level threaded rod bracket. Accepts 1/4" – 3/8" threaded rod. Maximum capacity of six J Hooks.	Galvanized Steel with Metal Attachments	180	81.65	10	50
Screw-On Beam Clamp Brackets						
JMJDWB-1-X	Single-level screw-on beam clamp bracket for use with flanges up to 3/4" thick.	Galvanized Steel with Metal Attachments	180	81.65	10	50
JMJDWB-3-X**	Three-level screw-on beam clamp bracket for use with flanges up to 3/4" thick. Maximum capacity of six J Hooks.	Galvanized Steel with Metal Attachments	180	81.65	10	50

*Suitable for use in air handling spaces and listed in accordance with UL 2043 and CAN/ULC S102.2 when mounted as single units or in pairs. Maximum spacing of 4' (1220mm) required between mount points. (Flame Spread Rating = 0, Smoke Developed Classification = 30)

**Not for use with chaining brackets.

A. System Overview

B1. Cable Ties

B2. Cable Accessories

B3. Stainless Steel Ties

C1. Wiring Duct

C2. Surface Raceway

C3. Abrasion Protection

C4. Cable Management

D1. Terminals

D2. Power Connectors

D3. Grounding Connectors

E1. Labeling Systems

E2. Labels

E3. Pre-Printed & Write-On Markers

E4. Permanent Identification

E5. Lockout/Tagout & Safety Solutions

F. Index

A.
System
Overview

Conduit Waterfall

B1.
Cable Ties

- Helps prevent pinch points and over bending that could cause damage to cable
- Suitable for use in air handling spaces per UL 2043
- UL listed per UL 1565

- Unique patent pending design allows for use in both new and retrofit applications
- Allows user to install 3/4" *TAK-TY*® Cable Ties to provide a method to retain and manage the cable bundle
- Material: Black Glass-Filled PBT meets UL 94V-0 specifications

B2.
Cable
Accessories

- Able to manage and support a large capacity of cables
- Easy and fast to install reducing labor cost

B3.
Stainless
Steel Ties



Part Number	Part Description	Std. Pkg. Qty.	Std. Ctn. Qty.
CWF400	Provides bend radius control for cables entering/exiting 4" EMT conduit. Secure to conduit without tools utilizing integral thumb screw and captive nut.	1	10

C1.
Wiring
Duct

C2.
Surface
Raceway

C3.
Abrasion
Protection

Waterfall Accessories

C4.
Cable
Management

- Patented bend radius control product
- Product available as a kit (includes base, two wings, and cable ties) or purchased separately
- Easy to install waterfall kit maintains bend radius control in both vertical and horizontal directions to provide a TIA/EIA-568-B compliant installation

- Base attaches to either the rung or stringer on most standard ladder racks for a variety of installations/configurations
- Modular components allow user to custom configure each location where cable management is required
- Material: Black Glass-Filled Nylon 6.6 meets UL 94V-0 specifications

D1.
Terminals

D2.
Power
Connectors

D3.
Grounding
Connectors

E1.
Labeling
Systems



CMW-KIT

Part Number	Part Description	Color*	Std. Pkg. Qty.	Std. Ctn. Qty.
CMW-KIT	Cable management waterfall kit. Provides bend radius control when transferring cables from standard ladder rack. Kit includes CMWB, two CMWW, and cable ties.	Black	1	10
CMWB	Cable management waterfall base. Used to maintain 1.75" bend radius control vertically when transferring cable off of ladder rack. Mounts to ladder rack rung or stringer with standard cross section cable ties (included).		1	10
CMWW	Cable management waterfall wing. Used in conjunction with CMWB to maintain 1.00" bend radius control horizontally when transferring cable off ladder rack.		1	10

*For white, include suffix of 10. For example: CMW-KIT10.

E2.
Labels



CMWB

E3.
Pre-Printed
& Write-On
Markers

E4.
Permanent
Identification



CMWW

E5.
Lockout/
Tagout/
& Safety
Solutions

F.
Index



Double Waterfall Accessory

- Double waterfall base attaches to the rung on most standard ladder racks to allow bend radius control for cables coming from either direction
- UL 94V-0 Rated Material
- Easy to install double waterfall base maintains bend radius control in a vertical direction to provide a TIA/EIA-568-B compliant installation



Part Number	Part Description	Color	Std. Pkg. Qty.	Std. Ctn. Qty.
CMW2B	Cable management double waterfall base. Used to maintain 1.75" bend radius control vertically when transferring cable off either side of ladder rack rung. Mounts to ladder rack rung with standard cross section cable ties (included).	Black	1	10

Stackable Cable Rack Spacers

- Patented ladder rack accessories
- Separate and support cable and prevent pinch points between the bottom row of cable and the rung as a result of the weight of multiple cable layers applied on top of each other
- Mount to ladder rack with standard cross section cable ties
- Maximize rack space by stacking products for maximum cable capacity
- Provide an alternative to lacing cord by allowing user to secure cable to spacer to prevent movement of cable
- Color: Black



CRS6-X



CRS1-X



CRS4-125-X



CRS1-125-X

Part Number	Part Description	Width		Std. Pkg. Qty.	Std. Ctn. Qty.
		In.	mm		
CRS6-X	Six space stackable cable rack spacer. Accepts cable up to .80" diameter.	5.25	133.4	10	100
CRS1-X	One space stackable cable rack spacer. Use with CRS6 to fill width of ladder rack. Accepts cable up to .80" diameter.	1.13	28.58	10	100
CRS4-125-X	Four space stackable cable rack spacer. Accepts cable up to 1.25" diameter.	5.24	133.1	10	100
CRS1-125-X	One space stackable cable rack spacer. Use with CRS4 to fill width of ladder rack. Accepts cable up to 1.25" diameter.	1.55	39.4	10	100

A. System Overview

B1. Cable Ties

B2. Cable Accessories

B3. Stainless Steel Ties

C1. Wiring Duct

C2. Surface Raceway

C3. Abrasion Protection

C4. Cable Management

D1. Terminals

D2. Power Connectors

D3. Grounding Connectors

E1. Labeling Systems

E2. Labels

E3. Pre-Printed & Write-On Markers

E4. Permanent Identification

E5. Lockout/Tagout & Safety Solutions

F. Index

A. System Overview

Threaded Rod Cover

B1. Cable Ties

- Protects cable from abrasion caused by contact with threaded rod
- Material meets UL 94V-0 specifications
- Available in 18 inch lengths
- Accept 1/2" to 5/8" threaded rod
- For indoor use only
- Material: Gray Polyethylene

B2. Cable Accessories



B3. Stainless Steel Ties

Part Number	Part Description	Std. Pkg. Qty.	Std. Ctn. Qty.
TRC18FR-X8	Used to protect cabling from threaded rod. Vertical slit allows easy installation.	10	100

C1. Wiring Duct

C2. Surface Raceway

C3. Abrasion Protection

Vertical D-Rings **PATENTED**

C4. Cable Management

- Patented cable manager ring
- Standard EIA hole spacing allows product to be mounted to any standard rack
- Flexible material allows arm to rotate so entire cable bundle can be inserted and removed
- 1/4" mounting holes allow for a variety of screws to secure the D-ring to a surface
- Material: Black Polycarbonate

D1. Terminals

D2. Power Connectors

D3. Grounding Connectors



E1. Labeling Systems



E2. Labels

E3. Pre-Printed & Write-On Markers



E4. Permanent Identification

E5. Lockout/Tagout & Safety Solutions

F. Index

Part Number	Part Description	Fiber	ScTP	UTP	Std. Pkg. Qty.	Std. Ctn. Qty.
CMVDR1	Vertical D-ring. Outside dimensions 5.70"L x 2.00"W.	252	48	96	1	10
CMVDR1S	Vertical D-ring. Outside dimensions 3.30"L x 2.00"W.	132	32	52	1	10
CMVDR2	Vertical D-ring. Outside dimensions 5.70"L x 3.00"W.	504	96	192	1	10
CMVDR2S	Vertical D-ring. Outside dimensions 3.30"L x 3.00"W.	252	48	96	1	10
CMVDRC	Center mounted vertical D-ring for routing cables between two adjacent racks. Requires 8.25" spacing between the center lines of the adjacent rack's mounting holes. Outside dimensions 5.60"L x 8.00"W.	1000	200	400	1	10

All product color is black.

TAK-TY® Hook & Loop Cable Tie Mounts

- For use with TAK-TY® Hook & Loop Cable Ties, see page B1.87
- Unique cradle design provides maximum stability for cable bundle
- For indoor use only
- Dimensions: 1.10"L x 1.10"W x .34"H (27.9mm x 27.9mm x 8.6mm)



Part Number	Used with Cable Ties‡	Material	Color	Max. Static Load		Mounting Method*	Std. Pkg. Qty.	Std. Ctn. Qty.	
				Lbs.	g				
ABMT-A-C	HLT	Nylon 6.6	Natural	.38	174	Rubber	100	1000	
ABMT-A-C20			Black						
ABMT-S6-C			Natural	—	—		#6 (M3) Screw	100	1000
ABMT-S6-C20			Black						
ABMT-S6-C60		Black	100			1000			
ABMT-S6-C69		Natural						100	1000

‡Cable tie cross section sizes: HLT/HLS = TAK-TY® Hook & Loop Ties.

*For proper selection of adhesives see page B2.52.

Flat PAN-POST™ Standoffs

- Standard EIA hole spacing allows product to be mounted with user supplied screws up to 1/4" diameter
- Organize cables in standard cabinets and racks
- Mounting method: 1/4" (M6) screw
- Use where space is limited
- For indoor use only



Part Number	Part Description	Std. Pkg. Qty.	Std. Ctn. Qty.
PPF2S-S25-V	Nylon 6.6 flat PAN-POST™ Standoff. Use with miniature, intermediate, and standard cross section cable ties. Dimensions 5.4"L x 1.5"H x .2"W (137.2mm x 38.1mm x 5.1mm).	5	100
PPF2S-S25-V69	Flame retardant Nylon 6.6 flat PAN-POST™ Standoff. Use with miniature, intermediate, and standard cross section cable ties. Material meets UL 94V-0 specifications. Dimensions 5.4"L x 1.5"H x .2"W (137.2mm x 38.1mm x 5.1mm).	5	100
PPF2SV-S25-V	Nylon 6.6 flat PAN-POST™ Standoff. Use with TAK-TY® Hook & Loop Cable Ties. Dimensions 5.6"L x 1.6"H x .2"W (142.2mm x 40.6mm x 5.1mm).	5	100
PPF2SV-S25-V69	Flame retardant Nylon 6.6 flat PAN-POST™ Standoff. Use with TAK-TY® Hook & Loop Cable Ties. Material meets UL 94V-0 specifications. Dimensions 5.6"L x 1.6"H x .2"W (144.8mm x 53.3mm x 5.1mm).	5	100

A. System Overview

B1. Cable Ties

B2. Cable Accessories

B3. Stainless Steel Ties

C1. Wiring Duct

C2. Surface Raceway

C3. Abrasion Protection

C4. Cable Management

D1. Terminals

D2. Power Connectors

D3. Grounding Connectors

E1. Labeling Systems

E2. Labels

E3. Pre-Printed & Write-On Markers

E4. Permanent Identification

E5. Lockout/Tagout & Safety Solutions

F. Index

A.
System
Overview

Communication Cable Management Kit for Cabinets

B1.
Cable Ties

- Kit of cable management accessories specifically designed for use in a network cabinet or enclosure

B2.
Cable
Accessories



B3.
Stainless
Steel Ties

Part Number	Part Description	Std. Pkg. Qty.	Std. Ctn. Qty.
CCMKIT1	Kit includes the following: 1 roll (15' length) .33" <i>TAK-TY</i> ® Cable Ties 24 nylon cable ties 12 adhesive backed cable tie mounts 6 push style cable tie mounts 4 vertical wire saddles 8 flat <i>PAN-POST</i> ™ Standoffs for use with std. nylon cable ties	1	100
CCMKIT2	Kit includes the following: 1 roll (15' length) .75" <i>TAK-TY</i> ® Cable Ties 12 nylon cable ties 6 adhesive backed cable tie mounts 6 adhesive backed mounts for .75" <i>TAK-TY</i> ® Cable Ties 6 screw mounts for .75" <i>TAK-TY</i> ® Cable Ties 4 vertical wire saddles 6 flat <i>PAN-POST</i> ™ Standoffs for use with .75" <i>TAK-TY</i> ® Cable Ties	1	100

Order the number of kits required.

C1.
Wiring
Duct

C2.
Surface
Raceway

C3.
Abrasion
Protection

C4.
Cable
Management

D1.
Terminals

D2.
Power
Connectors

D3.
Grounding
Connectors

E1.
Labeling
Systems

E2.
Labels

E3.
Pre-Printed
& Write-On
Markers

E4.
Permanent
Identification

E5.
Lockout/
Tagout/
& Safety
Solutions

F.
Index

PAN-TERM® TERMINALS

PANDUIT® PAN-TERM® Terminals are designed and manufactured for fast assembly, and reliable performance. PANDUIT provides an extensive line of tooling designed specifically to provide optimum performance. As the demand for loose piece terminals increases, it becomes essential to provide a complete system for termination products.



- Funnel entry available on vinyl and nylon insulated terminals and disconnects, speeds insertion, and minimizes turned back wire strands
- Made of electrolytic copper to provide an optimum combination of crimp forming and high conductivity properties to provide superior terminations
- Offered in various types including rings, forks, flanged forks, locking forks and short locking forks
- Available in sizes from #26 – 2 AWG and stud hole diameters from #2 – 1/2"; non-insulated tubular terminals sizes from #8 – 250 kcmil
- Applicable sizes are UL Listed and CSA Certified, RoHS compliant, ABS (American Bureau of Shipping) Approved, Class IE Nuclear Rated, DFARS 252.225-7014 Compliant and meet Military Specifications MS25036 and MS20659 as noted
- Wide assortment of manual, controlled cycle, battery operated hydraulic and pneumatic crimping tools for reliable connections at the lowest installed cost

PANDUIT continually provides new designs to meet the application challenges encountered by our customers. PANDUIT offers a wide assortment of PAN-TERM® termination products to meet customer needs at the lowest installed cost.

A.
System
Overview

B1.
Cable Ties

B2.
Cable
Accessories

B3.
Stainless
Steel Ties

C1.
Wiring
Duct

C2.
Surface
Raceway

C3.
Abrasion
Protection

C4.
Cable
Management

D1.
Terminals

D2.
Power
Connectors

D3.
Grounding
Connectors

E1.
Labeling
Systems

E2.
Labels

E3.
Pre-Printed
& Write-On
Markers

E4.
Permanent
Identification

E5.
Lockout/
Tagout
& Safety
Solutions

F.
Index

A.
System
Overview

Features and Benefits – PAN-TERM® Terminals

B1.
Cable Ties

All PANDUIT terminals feature high quality materials made with electrolytic copper for high conductivity and are tin-plated for corrosion resistance.

B2.
Cable
Accessories

Non-Insulated Terminals Type P

Maximum recommended operating temperature 302°F (150°C)

Product markings provide easy identification of wire size



Extended barrel length assures a good quality crimp and makes crimping easier

Internal barrel serrations assure good wire contact and maximum tensile strength

Brazed seam assures crimp reliability

Internally beveled barrel for quick easy wire insertion



UL and CSA rated up to 2000 V per UL 486A.
Nickel plated terminals rated up to 650°F (343°C) maximum operating temperature.

Nylon Insulated Terminals with Insulation Grip Sleeve Type PN or PNF

Internal barrel serrations assure good wire contact and maximum tensile strength

Insulation grip sleeve provides a superior insulation crimp for high vibration and high strain relief applications

Funnel entry for faster insertion and lower installed cost



Maximum insulation temperature 221°F (105°C)

Sleeved barrel assures crimp reliability

Color coded insulation identifies wire range



UL and CSA rated up to 600 V per UL 486.
Flammability – UL 94V-2/HB.
Proprietary blend of UL 94V-2 and UL 94HB flammability rated materials.

D1.
Terminals

Vinyl Insulated Terminals With Insulation Support Type PV

Internal barrel serrations assure good wire contact and maximum tensile strength

Insulation crimp provides insulation support to protect electrical crimp

Funnel entry for faster insertion and lower installed cost



Maximum insulation temperature 221°F (105°C)

Brazed seam assures crimp reliability

Color coded insulation identifies wire range



UL and CSA rated up to 600 V per UL 486.
Flammability – UL 94V-0.

Non-Insulated Seamless Tubular Terminals Type S

Internally beveled barrel for quick easy wire insertion

Seamless tubular barrel provides consistent, high performance, quality crimps

Maximum recommended operating temperature 302°F (150°C)



Inspection hole allows visual inspection for proper wire insertion

Product markings provide easy identification of wire sizes

Double thickness provides a strong ring tongue



UL and CSA rated up to 2000 V per UL 486A.

D2.
Power
Connectors

D3.
Grounding
Connectors

E1.
Labeling
Systems

E2.
Labels

E3.
Pre-Printed
& Write-On
Markers

E4.
Permanent
Identification

E5.
Lockout/
Tagout
& Safety
Solutions

F.
Index



PANDUIT extensive line of tooling is specifically designed for optimum crimping performance.

See pages D1.83 – D1.88.



PANDUIT designs and manufactures a full line of labeling products, software and printers to assist you with your labeling requirements.

See pages E1.1 – E2.30.

Selection Guide – PAN-TERM® Ring Terminals

Insulation Material		Style	Feature	Type	Page Number
Ring Terminals	Nylon	Standard Ring	Insulation Grip	PN-R	D1.6
			Funnel Entry	PNF-R	D1.8
			Expanded Insulation	PN-RX	D1.7
			Heavy Duty	PN-HDR	D1.13
		Multiple Stud	Insulation Grip	PN-610R	D1.9
	Vinyl	Standard Ring	Insulation Support	PV-R	D1.10
			Expanded Insulation	PV-RX	D1.11
			Heavy Duty	PV-HDR	D1.14
			Large Wire, Insulation Support	PV-R/X	D1.15
		Expanded Insulation, Insulation Support	PV-RX	D1.16	
Multiple Stud	Insulation Support	PV-610R	D1.12		
Heat Shrink	Standard Ring	Heat Shrink Insulation	PH-R	D1.13	
KYNAR [®] Insulated	Standard Ring	Insulation Grip	PK-R	D1.12	
Non-Insulated	Standard Ring	Brazed Seam	P-R	D1.17	
		High Temp, Brazed Seam	P-RHT	D1.18	
		Heavy Duty	P-HDR	D1.19	
		Large Wire	P-R	D1.19	
	Multiple Stud	Brazed Seam	P-610R	D1.18	
	Tubular Ring	Large Wire, Seamless Barrel	S-R	D1.20	



▪KYNAR is a registered trademark of Atofina Chemicals, Inc.

A. System Overview

B1. Cable Ties

B2. Cable Accessories

B3. Stainless Steel Ties

C1. Wiring Duct

C2. Surface Raceway

C3. Abrasion Protection

C4. Cable Management

D1. Terminals

D2. Power Connectors

D3. Grounding Connectors

E1. Labeling Systems

E2. Labels

E3. Pre-Printed & Write-On Markers

E4. Permanent Identification

E5. Lockout/Tagout & Safety Solutions

F. Index

Selection Guide – PAN-TERM® Fork Terminals

A. System Overview

B1. Cable Ties

B2. Cable Accessories

B3. Stainless Steel Ties

C1. Wiring Duct

C2. Surface Raceway

C3. Abrasion Protection

C4. Cable Management

D1. Terminals

D2. Power Connectors

D3. Grounding Connectors

E1. Labeling Systems

E2. Labels

E3. Pre-Printed & Write-On Markers

E4. Permanent Identification

E5. Lockout/Tagout & Safety Solutions

F. Index

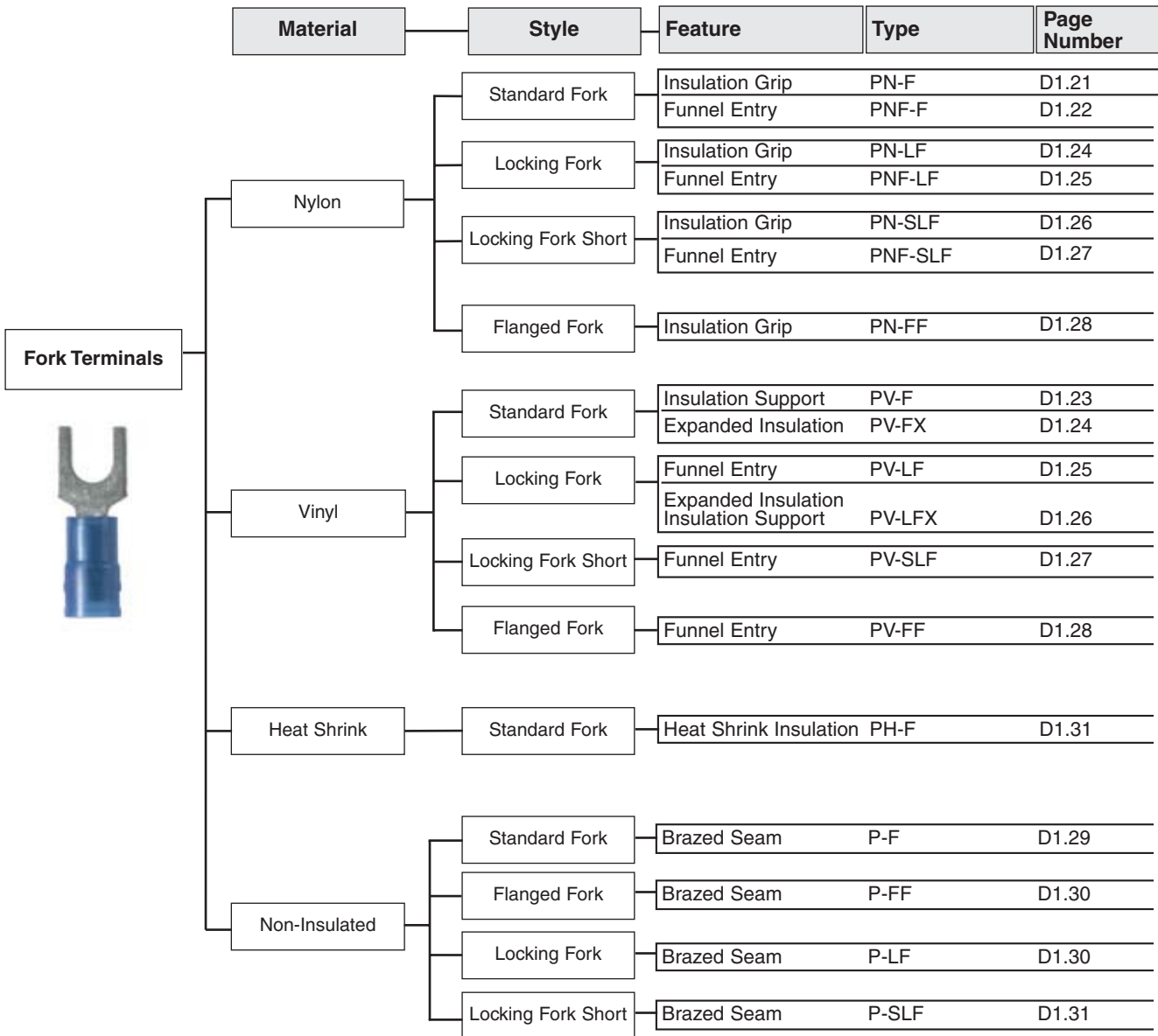

Part Number System for *PAN-TERM*® Terminals

<u>P</u>	<u>N</u>	<u>14</u>	<u>4</u>	<u>R</u>	<u>X</u>	<u>C</u>
Type	Insulation	Wire Range	Stud Size	Tongue Configuration	Special Configuration	Std. Pkg. Size
P = Seamed Barrel	K = KYNAR [®] Insulated	22 = #26 - 22 18 = #22 - 18	2 = #2 4 = #4	HDR = Heavy Duty Ring F = Fork	HT6 = High Temperature	5 = 5 X = 10
S = Seamless Tubular Barrel	N = Nylon Insulated NF = Nylon Insulated Funnel Entry V = Vinyl Insulated Non-Ins. (leave blank)	14 = #16 - 14 12 = #16 - 12 10 = #12 - 10 8 = #8 6 = #6 4 = #4 2 = #2 1 = #1 1/0 = 1/0 2/0 = 2/0 3/0 = 3/0 4/0 = 4/0 250 = 250kcmil	5 = #5 6 = #6 8 = #8 10 = #10 14 = 1/4" 56 = 5/16" 38 = 3/8" 76 = 7/16" 12 = 1/2"	FF = Flanged Fork LF = Locking Fork R = Ring SLF = Short Locking Fork	N = Narrow Tongue W = Wide Tongue X = Expanded Insulation = Non-Expanded Insulation (leave blank)	E = 20 Q = 25 L = 50 C = 100 T = 200 D = 500 M = 1000

■KYNAR is a registered trademark of Atofina Chemicals, Inc.

A.
System
Overview

B1.
Cable Ties

B2.
Cable
Accessories

B3.
Stainless
Steel Ties

C1.
Wiring
Duct

C2.
Surface
Raceway

C3.
Abrasion
Protection

C4.
Cable
Management

D1.
Terminals

D2.
Power
Connectors

D3.
Grounding
Connectors

E1.
Labeling
Systems

E2.
Labels

E3.
Pre-Printed
& Write-On
Markers

E4.
Permanent
Identification

E5.
Lockout/
Tagout
& Safety
Solutions

F.
Index

A. System Overview

B1. Cable Ties

B2. Cable Accessories

B3. Stainless Steel Ties

C1. Wiring Duct

C2. Surface Raceway

C3. Abrasion Protection

C4. Cable Management

D1. Terminals

D2. Power Connectors

D3. Grounding Connectors

E1. Labeling Systems

E2. Labels

E3. Pre-Printed & Write-On Markers

E4. Permanent Identification

E5. Lockout/Tagout & Safety Solutions

F. Index



Ring Terminal, Nylon Insulated

Type PN-R

- Ring tongue design assures a secure connection in high vibration applications
- Metal insulation grip sleeve crimps to wire insulation, providing protection to the crimp joint during high vibration applications
- Internal barrel serrations assure good wire contact and maximum tensile strength

- UL Flammability UL 94V-2/HB, maximum insulation temperature 221°F (105°C)
- UL and CSA rated up to 600 V per UL 486

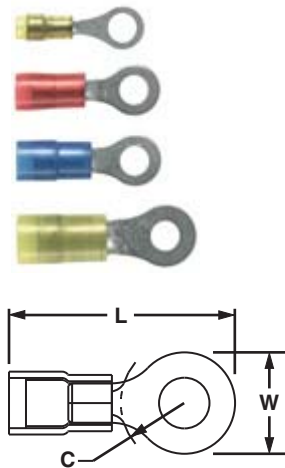

Part Number	Wire Range	Color Code	Stock Thickness	Max. Ins.	Stud Size	Figure Dimensions (In.)			Recommended Installation Tool	Std. Pkg. Qty.**	Std. Ctn. Qty.	
						L	W	C				
PN22-2R-C*	26 – 22 AWG	Yellow	.02	.090	#2	.69	.20	.18	CT-100, CT-600-A, CT-1525, CT-2500	100	1000	
PN22-4R-C*			.02	.090	#4	.69	.20	.18		100	1000	
PN22-6R-C*			.02	.090	#6	.69	.20	.18		100	1000	
PN22-8R-C*			.02	.090	#8	.78	.26	.26		100	1000	
PN22-10R-C*	22 – 18 AWG	Red	.02	.090	#10	.78	.31	.24	CT-100‡, CT-600-A‡, CT-1550‡, CT-1551‡, CT-2500‡	100	1000	
PN18-4RN-C^			.03	.145	#4	.74	.22	.18		100	500	
PN18-4R-C			.03	.145	#4	.80	.25	.22		100	500	
PN18-6RN-C^			.03	.145	#6	.77	.22	.18		100	500	
PN18-6R-C^			.03	.145	#6	.80	.25	.22		100	500	
PN18-8R-C^			.03	.145	#8	.86	.31	.25		100	500	
PN18-10R-C^			.03	.145	#10	.88	.31	.25		100	500	
PN18-14R-C^			.03	.145	1/4"	1.09	.45	.38		100	500	
PN18-56R-C^	18 – 14 AWG	Blue	.03	.145	5/16"	1.09	.46	.38	CT-100‡, CT-600-A‡, CT-1550‡, CT-1551‡, CT-2500‡	100	500	
PN18-38R-C^			.03	.145	3/8"	1.17	.53	.43		100	500	
PN18-12R-C			.03	.145	1/2"	1.35	.72	.53		100	500	
PN14-4R-C^			.03	.162	#4	.78	.25	.20		CT-100‡, CT-600-A‡, CT-1550‡, CT-1551‡, CT-2500‡	100	500
PN14-6RN-C^			.03	.162	#6	.76	.25	.20			100	500
PN14-6R-C^			.03	.162	#6	.85	.31	.25			100	500
PN14-8R-C^	.03	.162	#8	.85	.31	.25	100	500				
PN14-10R-C^	.03	.162	#10	.85	.31	.25	100	500				
PN14-14R-C^	.03	.162	1/4"	1.05	.46	.38	100	500				
PN14-56R-C^	12 – 10 AWG	Yellow	.03	.162	5/16"	1.05	.46	.38	CT-100‡, CT-600-A‡, CT-1550‡, CT-1551‡, CT-2500‡	100	500	
PN14-38R-L^			.03	.162	3/8"	1.14	.53	.43		50	500	
PN14-12R-L			.03	.162	1/2"	1.35	.72	.53		50	500	
PN10-6R-L^			.04	.225	#6	1.06	.37	.31		CT-100‡, CT-600-A‡, CT-1550‡, CT-1551‡, CT-2500‡	50	500
PN10-8R-L^			.04	.225	#8	1.06	.37	.31			50	500
PN10-10R-L^			.04	.225	#10	1.06	.38	.31			50	500
PN10-14R-L^	.04	.225	1/4"	1.21	.52	.38	50	500				
PN10-56R-L^	.04	.225	5/16"	1.21	.52	.38	50	500				
PN10-38R-L^	.04	.225	3/8"	1.29	.58	.43	50	500				
PN10-12R-L	.04	.225	1/2"	1.47	.72	.53	50	500				

*Wire sizes #26 – 22 AWG, are not UL Listed or CSA Certified.

**To order in bulk, replace -C in the part number with -M for a bulk package of 1000 and replace -L with -D for a bulk package of 500.

^For military specification cross reference see page D1.95

‡UL and CSA approved tooling/product combinations. For crimping tool information, see pages D1.83, D1.84, D1.86 and D1.88.



Ring Terminal, Nylon Insulated – Expanded Insulation

Type PN-RX

- Expanded wire entry designed to accommodate wire with a larger insulation thickness
- Ring tongue design assures a secure connection in high vibration applications
- Metal insulation grip sleeve crimps to wire insulation, providing protection to the crimp joint during high vibration applications
- Internal barrel serrations assure good wire contact and maximum tensile strength
- UL Flammability UL 94V-2/HB, maximum insulation temperature 221°F (105°C)
- UL and CSA rated up to 600 V per UL 486

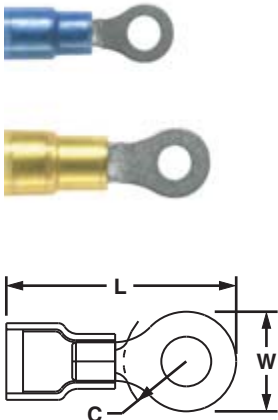

Part Number	Wire Range	Color Code	Stock Thickness	Max. Ins.	Stud Size	Figure Dimensions (In.)			Recommended Installation Tool	Std. Pkg. Qty.**	Std. Ctn. Qty.
						L	W	C			
PN14-6RX-C	16 – 14 AWG	Blue	.03	.200	#6	.93	.31	.25	CT-100‡, CT-600-A‡, CT-1550‡, CT-1551‡, CT-2500‡	100	500
PN14-8RX-C			.03	.200	#8	.93	.31	.25		100	500
PN14-10RX-C			.03	.200	#10	.93	.31	.25		100	500
PN14-14RX-C			.03	.200	1/4"	1.13	.46	.38		100	500
PN10-6RX-L	12 – 10 AWG	Yellow	.04	.265	#6	1.13	.37	.33	CT-100‡, CT-600-A‡, CT-1550‡, CT-1551‡, CT-2500‡	50	500
PN10-8RX-L			.04	.265	#8	1.13	.37	.33		50	500
PN10-10RX-L			.04	.265	#10	1.13	.37	.33		50	500
PN10-14RX-L			.04	.265	1/4"	1.27	.52	.42		50	500
PN10-56RX-L			.04	.265	5/16"	1.27	.52	.42		50	500
PN10-38RX-L			.04	.265	3/8"	1.35	.58	.46		50	500

**To order in bulk, replace -C in the part number with -M for a bulk package of 1000 and replace -L with -D for a bulk package of 500.

‡UL and CSA approved tooling/product combinations. For crimping tool information, see pages D1.83, D1.84, D1.86 and D1.88.

A. System Overview

B1. Cable Ties

B2. Cable Accessories

B3. Stainless Steel Ties

C1. Wiring Duct

C2. Surface Raceway

C3. Abrasion Protection

C4. Cable Management

D1. Terminals

D2. Power Connectors

D3. Grounding Connectors

E1. Labeling Systems

E2. Labels

E3. Pre-Printed & Write-On Markers

E4. Permanent Identification

E5. Lockout/Tagout & Safety Solutions

F. Index

A. System Overview

B1. Cable Ties



Ring Terminal, Nylon Insulated – Funnel Entry

Type PNF-R

- Ring tongue design assures a secure connection in high vibration applications
- Metal insulation grip sleeve crimps to wire insulation, providing protection to the crimp joint during high vibration applications
- Internal barrel serrations assure good wire contact and maximum tensile strength

- UL Flammability UL 94V-2/HB, maximum insulation temperature 221°F (105°C)
- UL and CSA rated up to 600 V per UL 486

B2. Cable Accessories

B3. Stainless Steel Ties

C1. Wiring Duct



C2. Surface Raceway



C3. Abrasion Protection



C4. Cable Management

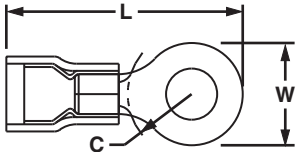

D1. Terminals

D2. Power Connectors

D3. Grounding Connectors

E1. Labeling Systems

E2. Labels

E3. Pre-Printed & Write-On Markers

E4. Permanent Identification

E5. Lockout/Tagout & Safety Solutions

F. Index

Part Number	Wire Range	Color Code	Stock Thickness	Max. Ins.	Stud Size	Figure Dimensions (In.)			Recommended Installation Tool	Std. Pkg. Qty.**	Std. Ctn. Qty.			
						L	W	C						
PNF18-4R-C	22 – 18 AWG	Red	.03	.136	#4	.77	.25	.20	CT-100‡, CT-600-A‡, CT-1550‡, CT-1551‡, CT-2500‡	100	500			
PNF18-6RN-C^			.03	.136	#6	.76	.22	.18		100	500			
PNF18-6R-C^			.03	.136	#6	.77	.25	.20		100	500			
PNF18-8R-C^			.03	.136	#8	.87	.31	.24		100	500			
PNF18-10R-C^			.03	.136	#10	.87	.32	.25		100	500			
PNF18-14R-C^			.03	.136	1/4"	1.08	.46	.38		100	500			
PNF18-56R-C^			.03	.136	5/16"	1.08	.46	.39		100	500			
PNF18-38R-C^			.03	.136	3/8"	1.16	.53	.41		100	500			
PNF14-4R-C^			16 – 14 AWG	Blue	.03	.162	#4	.78		.25	.18	CT-100‡, CT-600-A‡, CT-1550‡, CT-1551‡, CT-2500‡	100	500
PNF14-6RN-C^					.03	.162	#6	.78		.25	.18		100	500
PNF14-6R-C^	.03	.162			#6	.87	.31	.24	100	500				
PNF14-8R-C^	.03	.162			#8	.87	.31	.25	100	500				
PNF14-10R-C^	.03	.162			#10	.85	.31	.29	100	500				
PNF14-14R-C^	.03	.162			1/4"	1.06	.46	.40	100	500				
PNF14-56R-C^	.03	.162			5/16"	1.06	.46	.40	100	500				
PNF14-38R-L^	.03	.162			3/8"	1.14	.53	.45	50	500				
PNF10-6R-L^	12 – 10 AWG	Yellow			.04	.225	#6	1.06	.37	.31	CT-100‡, CT-600-A‡, CT-1550‡, CT-1551‡, CT-2500‡		50	500
PNF10-8R-L^					.04	.225	#8	1.06	.37	.31			50	500
PNF10-10R-L^			.04	.225	#10	1.06	.37	.31	50	500				
PNF10-14R-L^			.04	.225	1/4"	1.21	.52	.38	50	500				
PNF10-56R-L^			.04	.225	5/16"	1.21	.52	.38	50	500				
PNF10-38R-L^			.04	.225	3/8"	1.29	.58	.43	50	500				

**To order in bulk, replace -C in the part number with -M for a bulk package of 1000 and replace -L with -D for a bulk package of 500.

^For military specification cross reference see page D1.95.

‡UL and CSA approved tooling/product combinations. For crimping tool information, see pages D1.83, D1.84, D1.86 and D1.88.

UL LISTED **SP CERTIFIED** **Multiple Stud Terminal, Nylon Insulated**

Type PN-610R

- Teardrop shaped mounting hole of multiple stud terminals permits use with #6, #8, or #10 size studs
- Ring tongue design assures a secure connection in high vibration applications
- Metal insulation grip sleeve crimps to wire insulation, providing protection to the crimp joint during high vibration applications
- Internal barrel serrations assure good wire contact and maximum tensile strength
- UL Flammability UL 94V-2/HB, maximum insulation temperature 221°F (105°C)
- UL and CSA rated up to 600 V per UL 486

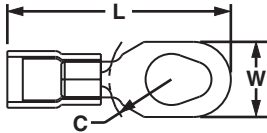

Part Number	Wire Range	Color Code	Stock Thickness	Max. Ins.	Stud Size	Figure Dimensions (In.)			Recommended Installation Tool	Std. Pkg. Qty.**	Std. Ctn. Qty.
						L	W	C			
PN18-610R-C	22 – 18 AWG	Red	.03	.145	#6, #8, #10	.95	.31	.25	CT-100‡, CT-600-A‡, CT-1550‡, CT-1551‡, CT-2500‡, CT-400	100	500
PN14-610R-C	16 – 14 AWG	Blue	.03	.165		.95	.31	.25			
PN10-610R-L	12 – 10 AWG	Yellow	.04	.225		1.17	.37	.33		50	500

**To order in bulk, replace -C or -CY in the part number with -M or -MY for a bulk package of 1000 and replace -L with -D for a bulk package of 500.
 ‡UL and CSA approved tooling/product combinations. For crimping tool information, see pages D1.83, D1.84, D1.86 and D1.88.

A. System Overview

B1. Cable Ties

B2. Cable Accessories

B3. Stainless Steel Ties

C1. Wiring Duct

C2. Surface Raceway

C3. Abrasion Protection

C4. Cable Management

D1. Terminals

D2. Power Connectors

D3. Grounding Connectors

E1. Labeling Systems

E2. Labels

E3. Pre-Printed & Write-On Markers

E4. Permanent Identification

E5. Lockout/Tagout & Safety Solutions

F. Index

A. System Overview

B1. Cable Ties

B2. Cable Accessories

B3. Stainless Steel Ties

C1. Wiring Duct

C2. Surface Raceway

C3. Abrasion Protection

C4. Cable Management

D1. Terminals

D2. Power Connectors

D3. Grounding Connectors

E1. Labeling Systems

E2. Labels

E3. Pre-Printed & Write-On Markers

E4. Permanent Identification

E5. Lockout/Tagout & Safety Solutions

F. Index



Ring Terminal, Vinyl Insulated – Funnel Entry

Type PV-R

- Insulation support helps to prevent wire damage in bending applications
- Ring tongue design assures a secure connection in high vibration applications
- Brazed seam protects terminal barrel from splitting during the crimp process
- UL Flammability UL 94V-0, maximum insulation temperature 221°F (105°C)
- Internal barrel serrations assure good wire contact and maximum tensile strength
- UL and CSA rated up to 600 V per UL 486

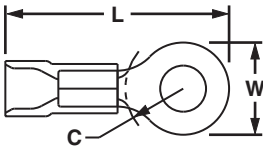

Part Number	Wire Range	Color Code	Stock Thickness	Max. Ins.	Stud Size	Figure Dimensions (In.)			Recommended Installation Tool	Std. Pkg. Qty.**	Std. Ctn. Qty.
						L	W	C			
PV22-2R-C*	26 – 22 AWG	Yellow	.02	.110	#2	.68	.21	.18	CT-100, CT-600-A, CT-1525, CT-2500	100	1000
PV22-4R-C*			.02	.110	#4	.68	.21	.18		100	1000
PV22-6R-C*			.02	.110	#6	.68	.21	.18		100	1000
PV22-8R-C*			.02	.110	#8	.78	.26	.26		100	1000
PV22-10R-C*			.02	.110	#10	.78	.32	.24		100	1000
PV18-4R-CY	22 – 18 AWG	Red	.03	.150	#4	.84	.25	.22	CT-100‡, CT-600-A‡, CT-1550‡, CT-1551‡, CT-2500‡	100	500
PV18-6R-CY			.03	.150	#6	.86	.25	.22		100	500
PV18-8R-CY			.03	.150	#8	.91	.31	.26		100	500
PV18-10R-CY			.03	.150	#10	.94	.31	.27		100	500
PV18-14R-CY			.03	.150	1/4"	1.11	.46	.37		100	500
PV18-56R-CY			.03	.150	5/16"	1.11	.46	.39		100	500
PV18-38R-CY			.03	.150	3/8"	1.19	.53	.42		100	500
PV18-12R-CY	.03	.150	1/2"	1.42	.72	.53	100	500			
PV14-4R-C	16 – 14 AWG	Blue	.03	.170	#4	.84	.25	.19	CT-100‡, CT-600-A‡, CT-1550‡, CT-1551‡, CT-2500‡	100	500
PV14-6RN-C			.03	.170	#6	.84	.25	.19		100	500
PV14-6R-C			.03	.170	#6	.92	.31	.25		100	500
PV14-8R-C			.03	.170	#8	.92	.31	.25		100	500
PV14-10R-C			.03	.170	#10	.92	.31	.25		100	500
PV14-14R-C			.03	.170	1/4"	1.12	.46	.38		100	500
PV14-56R-C			.03	.170	5/16"	1.12	.46	.38		100	500
PV14-38R-L			.03	.170	3/8"	1.21	.53	.43		50	500
PV14-12R-L			.03	.170	1/2"	1.42	.72	.53		50	500
PV10-6R-L			12 – 10 AWG	Yellow	.04	.225	#6	1.05		.31	.31
PV10-8R-L	.04	.225			#8	1.05	.31	.31	50	500	
PV10-10R-L	.04	.225			#10	1.05	.31	.31	50	500	
PV10-14R-L	.04	.225			1/4"	1.23	.52	.38	50	500	
PV10-56R-L	.04	.225			5/16"	1.23	.52	.38	50	500	
PV10-38R-L	.04	.225			3/8"	1.31	.58	.41	50	500	
PV10-12R-L	.04	.225			1/2"	1.46	.72	.53	50	500	

*Wire sizes #26 – 22 AWG, are not UL Listed or CSA Certified.

**To order in bulk, replace -C or -CY in the part number with -M or -MY for a bulk package of 1000 and replace -L with -D for a bulk package of 500.

‡UL and CSA approved tooling/product combinations. For crimping tool information, see pages D1.83, D1.84, D1.86 and D1.88.



Ring Terminal, Vinyl Expanded Insulation

Type PV-RX

- Expanded wire entry designed to accommodate wire with a larger insulation thickness
- Ring tongue design assures a secure connection in high vibration applications
- Insulation support helps to prevent wire damage in bending applications
- Brazed seam protects terminal barrel from splitting during the crimp process
- UL Flammability UL 94V-0, maximum insulation temperature 221°F (105°C)
- Internal barrel serrations assure good wire contact and maximum tensile strength
- UL and CSA rated up to 600 V per UL 486

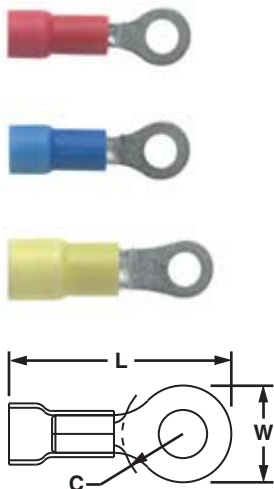

Part Number	Wire Range	Color Code	Stock Thickness	Max. Ins.	Stud Size	Figure Dimensions (in.)			Recommended Installation Tool	Std. Pkg. Qty.**	Std. Ctn. Qty.
						L	W	C			
PV18-4RX-CY	22 – 18 AWG	Red	.03	.170	#4	.88	.25	.22	CT-100‡, CT-600-A‡, CT-1550‡, CT-1551‡, CT-2500‡	100	500
PV18-6RX-CY			.03	.170	#6	.89	.25	.22		100	500
PV18-8RX-CY			.03	.170	#8	.97	.31	.27		100	500
PV18-10RX-CY			.03	.170	#10	.96	.31	.27		100	500
PV18-14RX-CY			.03	.170	1/4"	1.17	.46	.40		100	500
PV18-56RX-CY			.03	.170	5/16"	1.17	.46	.40		100	500
PV18-38RX-CY			.03	.170	3/8"	1.25	.53	.45		100	500
PV14-4RX-C	16 – 14 AWG	Blue	.03	.200	#4	.87	.25	.19	CT-100‡, CT-600-A‡, CT-1550‡, CT-1551‡, CT-2500‡	100	500
PV14-6RX-C			.03	.200	#6	.96	.31	.25		100	500
PV14-8RX-C			.03	.200	#8	.96	.31	.25		100	500
PV14-10RX-C			.03	.200	#10	.96	.31	.25		100	500
PV14-14RX-C			.03	.200	1/4"	1.16	.46	.37		100	500
PV14-56RX-C			.03	.200	5/16"	1.16	.46	.37		100	500
PV14-38RX-L			.03	.200	3/8"	1.25	.53	.42		50	500
PV10-6RX-L	12 – 10 AWG	Yellow	.04	.250	#6	1.10	.31	.30	CT-100‡, CT-600-A‡, CT-1550‡, CT-1551‡, CT-2500‡	50	500
PV10-8RX-L			.04	.250	#8	1.10	.31	.30		50	500
PV10-10RX-L			.04	.250	#10	1.10	.31	.30		50	500
PV10-14RX-L			.04	.250	1/4"	1.29	.52	.39		50	500
PV10-56RX-L			.04	.250	5/16"	1.29	.52	.42		50	500
PV10-38RX-L			.04	.250	3/8"	1.39	.58	.46		50	500

**To order in bulk, replace -C or -CY in the part number with -M or -MY for a bulk package of 1000 and replace -L with -D for a bulk package of 500.

‡UL and CSA approved tooling/product combinations. For crimping tool information, see pages D1.83, D1.84, D1.86 and D1.88.

A. System Overview

B1. Cable Ties

B2. Cable Accessories

B3. Stainless Steel Ties

C1. Wiring Duct

C2. Surface Raceway

C3. Abrasion Protection

C4. Cable Management

D1. Terminals

D2. Power Connectors

D3. Grounding Connectors

E1. Labeling Systems

E2. Labels

E3. Pre-Printed & Write-On Markers

E4. Permanent Identification

E5. Lockout/Tagout & Safety Solutions

F. Index

A. System Overview

B1. Cable Ties

B2. Cable Accessories

B3. Stainless Steel Ties

C1. Wiring Duct

C2. Surface Raceway

C3. Abrasion Protection

C4. Cable Management

D1. Terminals

D2. Power Connectors

D3. Grounding Connectors

E1. Labeling Systems

E2. Labels

E3. Pre-Printed & Write-On Markers

E4. Permanent Identification

E5. Lockout/Tagout & Safety Solutions

F. Index



Multiple Stud Terminal, Vinyl Insulated – Funnel Entry

Type PV-610R

- Teardrop shaped mounting hole of multiple stud terminals permits use with #6, #8, or #10 size studs
- Ring tongue design assures a secure connection in high vibration applications
- Insulation support helps to prevent wire damage in bending applications
- Brazed seam protects terminal barrel from splitting during the crimp process
- UL Flammability UL 94V-0, maximum insulation temperature 221°F (105°C)
- Internal barrel serrations assure good wire contact and maximum tensile strength
- UL and CSA rated up to 600 V per UL 486

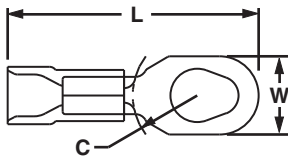

Part Number	Wire Range	Color Code	Stock Thickness	Max. Ins.	Stud Size	Figure Dimensions (In.)			Recommended Installation Tool	Std. Pkg. Qty.**	Std. Ctn. Qty.
						L	W	C			
PV18-610R-CY	22 – 18 AWG	Red	.03	.150	#6, #8, #10	1.00	.31	.25	CT-100, CT-600-A‡, CT-1550‡, CT-1551‡, CT-2500‡	100	500
PV14-610R-C	16 – 14 AWG	Blue	.03	.170		1.00	.31	.25		100	500
PV10-610R-L	12 – 10 AWG	Yellow	.04	.225		1.17	.37	.31		50	500

**To order in bulk, replace -C or -CY in the part number with -M or -MY for a bulk package of 1000 and replace -L with -D for a bulk package of 500.

‡UL and CSA approved tooling/product combinations. For crimping tool information, see pages D1.83, D1.84, D1.86 and D1.88.



Ring Terminal, KYNAR® Insulated

Type PK-R

- For nuclear containment areas and high temperature to 300°F (150°C) applications
- Color code: natural with appropriate color stripe to identify wire range
- Ring tongue design assures a secure connection in high vibration applications
- Classified as Class 1E in accordance with IEEE 323-2003
- Metal insulation grip sleeve crimps to wire insulation, providing protection to the crimp joint during high vibration applications

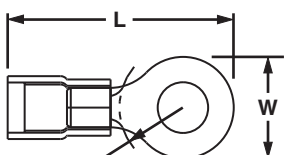

Part Number	Wire Range	Color Code	Stock Thickness	Max. Ins.	Stud Size	Figure Dimensions (In.)			Recommended Installation Tool	Std. Pkg. Qty.**	Std. Ctn. Qty.
						L	W	C			
PK18-4R-C	22 – 18 AWG	Red Stripe	.03	.145	#4	.81	.25	.22	CT-100, CT-600-A‡, CT-1550‡, CT-1551‡, CT-2500‡	100	500
PK18-6R-C			.03	.145	#6	.81	.25	.22		100	500
PK18-8R-C			.03	.145	#8	.90	.31	.29		100	500
PK18-10R-C			.03	.145	#10	.90	.31	.29		100	500
PK14-4R-C	16 – 14 AWG	Blue Stripe	.03	.162	#4	.79	.25	.22	CT-100, CT-600-A‡, CT-1550‡, CT-1551‡, CT-2500‡	100	500
PK14-6R-C			.03	.162	#6	.88	.31	.29		100	500
PK14-8R-C			.03	.162	#8	.88	.31	.29		100	500
PK14-10R-C			.03	.162	#10	.88	.31	.29		100	500
PK14-14R-C			.03	.162	1/4"	1.09	.46	.40	100	500	
PK10-6R-L	12 – 10 AWG	Yellow Stripe	.04	.225	#6	1.08	.37	.33	CT-100, CT-600-A‡, CT-1550‡, CT-1551‡, CT-2500‡	50	500
PK10-8R-L			.04	.225	#8	1.08	.37	.33		50	500
PK10-10R-L			.04	.225	#10	1.08	.37	.33		50	500
PK10-14R-L			.04	.225	1/4"	1.23	.52	.42		50	500

*KYNAR is a registered trademark of Atofina Chemicals, Inc.

‡UL approved tooling/product combinations. For tooling information, see pages D1.83, D1.84, D1.86 and D1.88.

UL LISTED SF CERTIFIED Heat Shrink, Ring Terminal

Type PH-R

- Heat shrink polyolefin sleeve with hot melt adhesive protects against moisture
- Heat shrink sleeving forms a protective barrier to provide environmentally sealed terminations ideal for high moisture applications
- Ring tongue design assures a secure connection in high vibration applications
- Brazed seam protects terminal barrel from splitting during the crimp process
- Heat shrink installation is completed with a standard heat gun
- Minimum continuous operating temperature -65°F (-55°C)
- Maximum continuous operation temperature 230°F (110°C)
- Shrink temperature 250°F (120°C)



Part Number	Wire Range	Color Code	Max. Ins.	Stud Size	Figure Dimensions (In.)			Wire Strip Length (In.)	Recommended Installation Tool	Std. Pkg. Qty.	Std. Ctn. Qty.
					L	W					
PH18-6R-Q	22 – 18 AWG	Red	.170	#6	1.05	.25		5/16	CT-310	25	125
PH18-8R-Q			.170	#8	1.08	.31		5/16		25	125
PH18-10R-Q			.170	#10	1.08	.31		5/16		25	125
PH18-14R-Q			.170	1/4"	1.30	.47		5/16		25	125
PH14-6R-Q	16 – 14 AWG	Blue	.190	#6	1.06	.31		5/16	CT-310	25	125
PH14-8R-Q			.190	#8	1.03	.31		5/16		25	125
PH14-10R-Q			.190	#10	1.12	.31		5/16		25	125
PH14-14R-Q			.190	1/4"	1.24	.46		5/16		25	125
PH14-56R-Q			.190	5/16"	1.27	.46		5/16		25	125
PH14-38R-Q			.190	3/8"	1.26	.53		5/16		25	125
PH10-8R-E	12 – 10 AWG	Yellow	.240	#8	1.22	.37		5/16	CT-310	20	100
PH10-10R-E			.240	#10	1.20	.37		5/16		20	100
PH10-14R-E			.240	1/4"	1.41	.52		5/16		20	100
PH10-38R-E			.240	3/8"	1.45	.59		5/16		20	100
PH10-12R-E			.240	1/2"	1.54	.72		5/16		20	100

For crimping tool information, see page D1.85.

UL LISTED SF CERTIFIED Ring Terminal, Heavy Duty, Nylon Insulated

Type PN-HDR

- Manufactured from stock 56% thicker than a standard #16 – 14 AWG terminal for use in heavy-duty applications
- Insulation housing is marked with "HDR" to signify heavy-duty ring
- Metal insulation grip sleeve crimps to wire insulation, providing protection to the crimp joint during high vibration applications
- Internal barrel serrations assure good wire contact and maximum tensile strength
- UL Flammability UL 94V-2/HB, maximum insulation temperature 221°F (105°C)
- UL and CSA rated up to 600 V per UL 486



Part Number	Wire Range	Color Code	Stock Thickness	Max. Ins.	Stud Size	Figure Dimensions (In.)			Recommended Installation Tool	Std. Pkg. Qty.**	Std. Ctn. Qty.
						L	W	C			
PN12-8HDR-L	16 – 12 AWG	Yellow	.05	.225	#8	1.06	.31	.35	CT-1550‡ CT-1551‡ CT-2500‡	50	500
PN12-10HDR-L			.05	.225	#10	1.09	.37	.33		50	500
PN12-14HDR-L			.05	.225	1/4"	1.24	.52	.42		50	500
PN12-56HDR-L			.05	.225	5/16"	1.24	.52	.42		50	500
PN12-38HDR-L			.05	.225	3/8"	1.30	.58	.46		50	500

**To order in bulk, replace -L with -D for a bulk package of 500.

‡UL and CSA approved tooling/product combinations. For crimping tool information, see pages D1.84 and D1.88.

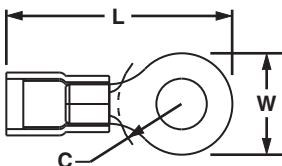

A. System Overview

B1. Cable Ties

B2. Cable Accessories

B3. Stainless Steel Ties

C1. Wiring Duct

C2. Surface Raceway

C3. Abrasion Protection

C4. Cable Management

D1. Terminals

D2. Power Connectors

D3. Grounding Connectors

E1. Labeling Systems

E2. Labels

E3. Pre-Printed & Write-On Markers

E4. Permanent Identification

E5. Lockout/Tagout & Safety Solutions

F. Index



Ring Terminal, Heavy Duty, Vinyl Insulated – Funnel Entry

Type PV-HDR

- Manufactured from stock 56% thicker than a standard #16 – 14 AWG terminal for use in heavy-duty applications
- Insulation housing is marked with “HDR” to signify heavy-duty ring
- Insulation support helps to prevent wire damage in bending applications
- Brazed seam protects terminal barrel from splitting during the crimp process
- UL Flammability UL 94V-0, maximum insulation temperature 221°F (105°C)
- Internal barrel serrations assure good wire contact and maximum tensile strength
- UL and CSA rated up to 600 V per UL 486

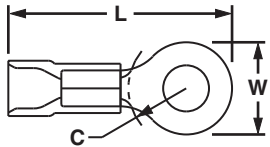

Part Number	Wire Range	Color Code	Stock Thickness	Max. Ins.	Stud Size	Figure Dimensions (In.)			Recommended Installation Tool	Std. Pkg. Qty.**	Std. Ctn. Qty.
						L	W	C			
Standard Insulation											
PV12-6HDR-L	16 – 12 AWG	Yellow	.05	.225	#6	1.05	.31	.35	CT-600-A‡, CT-1550‡, CT-1551‡, CT-2500‡	50	500
PV12-8HDR-L			.05	.225	#8	1.05	.31	.35		50	500
PV12-10HDR-L			.05	.225	#10	1.08	.37	.33		50	500
PV12-14HDR-L			.05	.225	1/4"	1.23	.52	.42		50	500
PV12-56HDR-L			.05	.225	5/16"	1.23	.52	.42		50	500
PV12-38HDR-L			.05	.225	3/8"	1.31	.58	.46		50	500
Expanded Insulation*											
PV12-6HDRX-L	16 – 12 AWG	Yellow	.05	.250	#6	1.05	.31	.35	CT-600-A‡, CT-1550‡, CT-1551‡, CT-2500‡	50	500
PV12-8HDRX-L			.05	.250	#8	1.05	.31	.35		50	500
PV12-10HDRX-L			.05	.250	#10	1.08	.37	.33		50	500
PV12-14HDRX-L			.05	.250	1/4"	1.23	.52	.42		50	500
PV12-56HDRX-L			.05	.250	5/16"	1.23	.52	.42		50	500
PV12-38HDRX-L			.05	.250	3/8"	1.31	.58	.46		50	500

*Expanded insulation parts do not have funnel entry.
 **To order in bulk, replace -L with -D for a bulk package of 500.
 ‡UL and CSA approved tooling/product combinations. For tooling information, see pages D1.84, D1.86, and D1.88.



Ring Terminal, Large Wire, Vinyl Insulated

Type PV-R

- Insulation support helps to prevent wire damage in bending applications
- Brazed seam protects terminal barrel from splitting during the crimp process
- UL Flammability UL 94V-0, maximum insulation temperature 221°F (105°C)
- Internal barrel serrations assure good wire contact and maximum tensile strength
- UL and CSA rated up to 600 V per UL 486

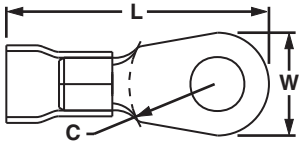

Part Number	Wire Range	Color Code	Stock Thickness	Max. Ins.	Stud Size	Figure Dimensions (In.)			Recommended Installation Tool	Std. Pkg. Qty.**	Std. Ctn. Qty.
						L	W	C			
PV8-8R-QY	8 AWG	Red	.04	.280	#8	1.51	.42	.43	CT-720, CD-720PV8-2‡	25	250
PV8-10R-QY			.04	.280	#10	1.53	.47	.43		25	250
PV8-14R-QY			.04	.280	1/4"	1.53	.47	.43		25	250
PV8-56R-QY			.04	.280	5/16"	1.64	.59	.49		25	250
PV8-38R-QY			.04	.280	3/8"	1.64	.59	.51		25	250
PV8-12R-QY			.04	.280	1/2"	1.74	.82	.51		25	250
PV6-8R-E	6 AWG	Blue	.05	.340	#8	1.61	.47	.43	CT-720, CD-720PV8-2‡	20	200
PV6-10R-E			.05	.340	#10	1.62	.47	.43		20	200
PV6-14R-E			.05	.340	1/4"	1.65	.47	.48		20	200
PV6-56R-E			.05	.340	5/16"	1.74	.62	.53		20	200
PV6-38R-E			.05	.340	3/8"	1.74	.62	.51		20	200
PV6-12R-E			.05	.340	1/2"	1.84	.82	.51		20	200
PV4-10R-E	4 AWG	Yellow	.05	.450	#10	1.88	.55	.50	CT-720, CD-720PV8-2‡	20	200
PV4-14R-E			.05	.450	1/4"	1.88	.55	.50		20	200
PV4-56R-E			.05	.450	5/16"	1.95	.68	.50		20	200
PV4-38R-E			.05	.450	3/8"	1.95	.68	.50		20	200
PV4-12R-E			.05	.450	1/2"	2.04	.86	.50		20	200
PV2-10R-XY	2 AWG	Red	.06	.560	#10	1.96	.68	.58	CT-720, CD-720PV8-2‡	10	100
PV2-14R-XY			.06	.560	1/4"	1.96	.68	.58		10	100
PV2-56R-XY			.06	.560	5/16"	1.96	.68	.58		10	100
PV2-38R-XY			.06	.560	3/8"	1.96	.68	.58		10	100
PV2-12R-XY			.06	.560	1/2"	2.05	.86	.58		10	100

**To order in bulk, replace -QY, -E, or -XY in the part number with -T or -TY for a bulk package of 200.
‡UL approved tooling/product combinations. For crimping tool information, see page D1.87.

A. System Overview

B1. Cable Ties

B2. Cable Accessories

B3. Stainless Steel Ties

C1. Wiring Duct

C2. Surface Raceway

C3. Abrasion Protection

C4. Cable Management

D1. Terminals

D2. Power Connectors

D3. Grounding Connectors

E1. Labeling Systems

E2. Labels

E3. Pre-Printed & Write-On Markers

E4. Permanent Identification

E5. Lockout/Tagout & Safety Solutions

F. Index

A. System Overview

B1. Cable Ties

B2. Cable Accessories

B3. Stainless Steel Ties

C1. Wiring Duct

C2. Surface Raceway

C3. Abrasion Protection

C4. Cable Management

D1. Terminals

D2. Power Connectors

D3. Grounding Connectors

E1. Labeling Systems

E2. Labels

E3. Pre-Printed & Write-On Markers

E4. Permanent Identification

E5. Lockout/Tagout & Safety Solutions

F. Index



Ring Terminal, Large Wire, Vinyl Expanded Insulation

Type PV-RX

- Expanded wire entry designed to accommodate wire with a larger insulation thickness
- Insulation support helps to prevent wire damage in bending applications
- Brazed seam protects terminal barrel from splitting during the crimp process
- UL Flammability UL 94V-0, maximum insulation temperature 221°F (105°C)
- Internal barrel serrations assure good wire contact and maximum tensile strength
- UL rated up to 600 V per UL 486

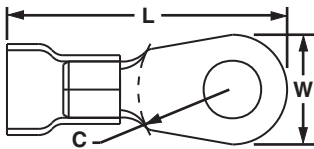

Part Number	Wire Range	Color Code	Stock Thickness	Max. Ins.	Stud Size	Figure Dimensions (In.)			Recommended Installation Tool	Std. Pkg. Qty.**	Std. Ctn. Qty.
						L	W	C			
PV8-8RX-QY	8 AWG	Red	.04	.360	#8	1.50	.42	.43	CT-720, CD-720PV8-2‡	25	250
PV8-10RX-QY			.04	.360	#10	1.52	.47	.43		25	250
PV8-14RX-QY			.04	.360	1/4"	1.52	.47	.43		25	250
PV8-56RX-QY			.04	.360	5/16"	1.62	.59	.51		25	250
PV8-38RX-QY			.04	.360	3/8"	1.62	.59	.51		25	250
PV8-12RX-QY			.04	.360	1/2"	1.74	.82	.51		25	250
PV6-8RX-E	6 AWG	Blue	.05	.436	#8	1.61	.47	.43	CT-720, CD-720PV8-2‡	20	200
PV6-10RX-E			.05	.436	#10	1.61	.47	.43		20	200
PV6-14RX-E			.05	.436	1/4"	1.61	.47	.43		20	200
PV6-56RX-E			.05	.436	5/16"	1.73	.62	.51		20	200
PV6-38RX-E			.05	.436	3/8"	1.73	.62	.53		20	200
PV6-12RX-E			.05	.436	1/2"	1.83	.82	.53		20	200
PV4-10RX-E	4 AWG	Yellow	.05	.515	#10	1.87	.55	.53	CT-720, CD-720PV8-2‡	20	200
PV4-14RX-E			.05	.515	1/4"	1.87	.55	.53		20	200
PV4-56RX-E			.05	.515	5/16"	1.94	.68	.53		20	200
PV4-38RX-E			.05	.515	3/8"	1.94	.68	.53		20	200
PV4-12RX-E			.05	.515	1/2"	2.03	.86	.53	20	200	
PV2-10RX-XY	2 AWG	Red	.06	.632	#10	1.94	.68	.58	CT-720, CD-720PV8-2‡	10	100
PV2-14RX-XY			.06	.632	1/4"	1.94	.68	.58		10	100
PV2-56RX-XY			.06	.632	5/16"	1.94	.68	.58		10	100
PV2-38RX-XY			.06	.632	3/8"	1.94	.68	.58		10	100
PV2-12RX-XY			.06	.632	1/2"	2.03	.86	.58		10	100

**To order in bulk, replace -QY, -E, or -XY in the part number with -T or -TY for a bulk package of 200.
‡UL approved tooling/product combinations. For crimping tool information, see pages D1.87 and D3.37.

UL LISTED **CSA CERTIFIED** **Ring Terminal, Non-Insulated**

Type P-R

- Ring tongue design assures a secure connection in high vibration applications
- Internal barrel serrations assure good wire contact and maximum tensile strength
- Brazed seam protects terminal barrel from splitting during the crimp process

- Barrel of terminal internally beveled to provide quick and easy wire insertion
- UL and CSA rated up to 2000 V per UL 486
- Maximum recommended operating temperature 302°F (150°C)

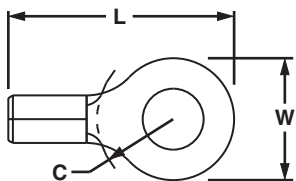

Part Number	Wire Range	Stock Thickness	Stud Size	Figure Dimensions (In.)			Recommended Installation Tool	Std. Pkg. Qty.**	Std. Ctn. Qty.		
				L	W	C					
P22-2R-C*	26 – 22 AWG	.02	#2	.52	.20	.16	CT-100, CT-200	100	1000		
P22-4R-C*		.02	#4	.52	.20	.16		100	1000		
P22-6R-C*		.02	#6	.52	.20	.16		100	1000		
P22-8R-C*		.02	#8	.63	.26	.25		100	1000		
P22-10R-C*		.02	#10	.63	.31	.22		100	1000		
P18-4R-C	22 – 16 AWG	.03	#4	.62	.25	.21	CT-100‡, CT-200‡, CT-600-A‡, CT-1570‡, CT-2500‡	100	1000		
P18-6RN-C		.03	#6	.60	.22	.19		100	1000		
P18-6R-C		.03	#6	.62	.25	.21		100	1000		
P18-8R-C		.03	#8	.71	.31	.25		100	1000		
P18-10R-C		.03	#10	.71	.31	.25		100	1000		
P18-14R-C		.03	1/4"	.91	.46	.38		100	1000		
P18-56R-C		.03	5/16"	.91	.46	.38		100	1000		
P18-38R-C		.03	3/8"	1.0	.53	.43		100	1000		
P18-12R-C		.03	1/2"	1.20	.72	.53		100	1000		
P14-4R-C		18 – 14 AWG	.03	#4	.62	.25		.20	CT-100‡, CT-200‡, CT-600-A‡, CT-1570‡, CT-2500‡	100	1000
P14-6R-C	.03		#6	.62	.25	.20	100	1000			
P14-8R-C	.03		#8	.71	.31	.25	100	1000			
P14-10R-C	.03		#10	.71	.31	.25	100	1000			
P14-14R-C	.03		1/4"	.91	.46	.38	100	1000			
P14-56R-C	.03		5/16"	.91	.46	.38	100	1000			
P14-38R-C	.03		3/8"	1.0	.53	.43	100	1000			
P14-12R-L	.03		1/2"	1.20	.72	.53	50	500			
P10-6R-L^	14 – 10 AWG		.04	#6	.78	.31	.31	CT-100‡, CT-200‡, CT-600-A‡, CT-1570‡, CT-1701‡, CT-2500‡		50	500
P10-8R-L			.04	#8	.78	.31	.31			50	500
P10-10R-L^		.04	#10	.81	.38	.31	50		500		
P10-14R-L		.04	1/4"	.96	.52	.38	50		500		
P10-56R-L^		.04	5/16"	.95	.52	.38	50		500		
P10-38R-L^		.04	3/8"	1.05	.58	.44	50		500		
P10-12R-L		.04	1/2"	1.20	.72	.53	50		500		

*Wire sizes #26 – 22 AWG are not UL Listed or CSA Certified.

**To order in bulk, replace -C in the part number with -M for a bulk package of 1000 and replace -L with -D for a bulk package of 500.

^For military specification cross reference see page D1.95.

‡UL and CSA approved tooling/product combinations. For crimping tool information, see pages D1.83, D1.84, D1.86 and D1.88.

A. System Overview

B1. Cable Ties

B2. Cable Accessories

B3. Stainless Steel Ties

C1. Wiring Duct

C2. Surface Raceway

C3. Abrasion Protection

C4. Cable Management

D1. Terminals

D2. Power Connectors

D3. Grounding Connectors

E1. Labeling Systems

E2. Labels

E3. Pre-Printed & Write-On Markers

E4. Permanent Identification

E5. Lockout/Tagout & Safety Solutions

F. Index

A. System Overview



Multiple Stud Terminal, Non-Insulated

B1. Cable Ties

Type P-610R

- Teardrop shaped mounting hole of multiple stud terminals permits use with #6, #8, or #10 size studs
- UL and CSA rated up to 2000 V per UL 486
- Maximum recommended operating temperature 302°F (150°C)
- Internal barrel serrations assure good wire contact and maximum tensile strength
- Brazed seam protects terminal barrel from splitting during the crimp process
- Barrel of terminal internally beveled to provide quick and easy wire insertion

- Internal barrel serrations assure good wire contact and maximum tensile strength
- Brazed seam protects terminal barrel from splitting during the crimp process
- Barrel of terminal internally beveled to provide quick and easy wire insertion
- UL and CSA rated up to 2000 V per UL 486A
- Maximum recommended operating temperature 302°F (150°C)
- Teardrop shaped mounting hole of multiple stud terminals permits use with #6, #8, or #10 size studs

B2. Cable Accessories

B3. Stainless Steel Ties

C1. Wiring Duct

C2. Surface Raceway

C3. Abrasion Protection

C4. Cable Management



Part Number	Wire Range	Stock Thickness	Stud Size	Figure Dimensions (In.)			Recommended Installation Tool	Std. Pkg. Qty.**	Std. Ctn. Qty.
				L	W	C			
P18-610R-C	22 – 16 AWG	.03	#6, #8, #10	.80	.31	.25	CT-100‡, CT-200‡, CT-600-A‡, CT-1570‡, CT-1701‡, CT-2500‡	100	500
P14-610R-C	18 – 14 AWG	.03		.80	.31	.25			
P10-610R-L	14 – 10 AWG	.04		.90	.37	.31		50	500

**To order in bulk, replace -C in the part number with -M for a bulk package of 1000 and replace -L with -D for a bulk package of 500.
‡UL and CSA approved tooling/product combinations. For tooling information, see pages D1.83, D1.84, D1.86 and D1.88.

D1. Terminals

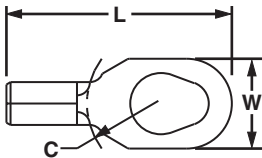

D2. Power Connectors

D3. Grounding Connectors

Ring Terminal, Non-Insulated – High Temperature

Type P-RHT

- Nickel plated copper for temperatures up to 650°F (343°C)
- Internal barrel serrations assure good wire contact and maximum tensile strength
- Brazed seam protects terminal barrel from splitting during the crimp process

- Barrel of terminal internally beveled to provide quick and easy wire insertion

E1. Labeling Systems

E2. Labels

E3. Pre-Printed & Write-On Markers

E4. Permanent Identification

E5. Lockout/Tagout & Safety Solutions

F. Index



Part Number	Wire Range	Stock Thickness	Stud Size	Figure Dimensions (In.)			Recommended Installation Tool	Std. Pkg. Qty.**	Std. Ctn. Qty.
				L	W	C			
P18-6RHT6-C	22 – 16 AWG	.03	#6	.62	.25	.21	CT-100, CT-200, CT-600-A, CT-1570, CT-2500	100	1000
P18-8RHT6-C		.03	#8	.71	.31	.25			
P18-10RHT6-C		.03	#10	.71	.31	.25		100	1000
P14-6RHT6-C	18 – 14 AWG	.03	#6	.62	.25	.20	CT-100, CT-200, CT-600-A, CT-1570, CT-2500	100	1000
P14-8RHT6-C		.03	#8	.71	.31	.25			
P14-10RHT6-C		.03	#10	.71	.31	.25		100	1000
P10-6RHT6-L	12 – 10 AWG	.04	#6	.78	.31	.35	CT-100, CT-200, CT-600-A, CT-1570, CT-1701, CT-2500	50	500
P10-8RHT6-L		.04	#8	.78	.31	.35			
P10-10RHT6-L		.04	#10	.81	.38	.33		50	500
P10-14RHT6-L		.04	1/4"	.96	.53	.42		50	500

**To order in bulk, replace -C in the part number with -M for a bulk package of 1000 and replace -L with -D for a bulk package of 500.
For crimping tool information, see pages D1.83, D1.84, D1.86 and D1.88.

UL LISTED CERTIFIED Ring Terminal, Heavy Duty Non-Insulated

Type P-HDR

- Manufactured from stock 56% thicker than a standard #16 – 14 AWG terminal for use in heavy-duty applications
- Internal barrel serrations assure good wire contact and maximum tensile strength
- Brazed seam protects terminal barrel from splitting during the crimp process
- Barrel of terminal internally beveled to provide quick and easy wire insertion
- UL and CSA rated up to 2000 V per UL 486
- Maximum recommended operating temperature 302°F (150°C)

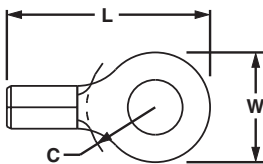

Part Number	Wire Range	Stock Thickness	Stud Size	Figure Dimensions (In.)			Recommended Installation Tool	Std. Pkg. Qty.**	Std. Ctn. Qty.
				L	W	C			
P12-6HDR-L	16 – 12 AWG	.05	#6	.78	.31	.36	CT-100, CT-200, CT-1570‡, CT-2500‡	50	500
P12-8HDR-L		.05	#8	.78	.31	.36		50	500
P12-10HDR-L		.05	#10	.81	.37	.36		50	500
P12-14HDR-L		.05	1/4"	.96	.52	.43		50	500
P12-56HDR-L		.05	5/16"	.96	.52	.43		50	500
P12-38HDR-L		.05	3/8"	1.04	.58	.48		50	500

**To order in bulk, replace -L with -D for a bulk package of 500.

‡UL and CSA approved tooling/product combinations. For crimping tool information, see pages D1.83, D1.84, and D1.88.

UL LISTED CERTIFIED Ring Terminal, Large Wire Non-Insulated

Type P-R

- Designed for use with #8 – 2 AWG copper wire
- Ring tongue design assures a secure connection in high vibration applications
- Internal barrel serrations assure good wire contact and maximum tensile strength
- Brazed seam protects terminal barrel from splitting during the crimp process
- Barrel of terminal internally beveled to provide quick and easy wire insertion
- Maximum recommended operating temperature 302°F (150°C)

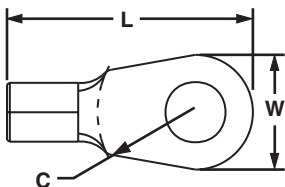

Part Number	Wire Range	Stock Thickness	Stud Size	Figure Dimensions (In.)			Recommended Installation Tool	Std. Pkg. Qty.**	Std. Ctn. Qty.
				L	W	C			
P8-8R-Q	8 AWG	.04	#8	1.12	.42	.43	CT-1701‡	25	250
P8-10R-Q		.04	#10	1.14	.47	.43		25	250
P8-14R-Q		.04	1/4"	1.14	.47	.43		25	250
P8-56R-Q		.04	5/16"	1.25	.59	.51		25	250
P8-38R-Q		.04	3/8"	1.25	.59	.51		25	250
P8-12R-Q		.04	1/2"	1.36	.82	.54		25	250
P6-8R-E	6 AWG	.05	#8	1.21	.47	.43	CT-1701‡	20	200
P6-10R-E		.05	#10	1.21	.47	.43		20	200
P6-14R-E		.05	1/4"	1.21	.47	.43		20	200
P6-56R-E		.05	5/16"	1.33	.62	.51		20	200
P6-38R-E		.05	3/8"	1.33	.62	.51		20	200
P6-12R-E		.05	1/2"	1.43	.82	.51		20	200
P4-10R-E	4 AWG	.05	#10	1.40	.55	.50	CT-1701‡	20	200
P4-14R-E		.05	1/4"	1.40	.55	.50		20	200
P4-56R-E		.05	5/16"	1.46	.68	.50		20	200
P4-38R-E		.05	3/8"	1.46	.68	.50		20	200
P4-12R-E		.05	1/2"	1.55	.86	.53		20	200
P2-10R-X		2 AWG	.06	#10	1.46	.68		.58	CT-1701‡
P2-14R-X	.06		1/4"	1.46	.68	.58	10	100	
P2-56R-X	.06		5/16"	1.46	.68	.58	10	100	
P2-38R-X	.06		3/8"	1.46	.68	.58	10	100	
P2-12R-X*	.06		1/2"	1.55	.86	.58	10	100	

*Not CSA Certified.

**To order in bulk, replace -Q, -E, or -X in the part number with -T for a bulk package of 200.

‡UL and CSA approved tooling/product combinations. For crimping tool information, see page D1.84.

A. System Overview

B1. Cable Ties

B2. Cable Accessories

B3. Stainless Steel Ties

C1. Wiring Duct

C2. Surface Raceway

C3. Abrasion Protection

C4. Cable Management

D1. Terminals

D2. Power Connectors

D3. Grounding Connectors

E1. Labeling Systems

E2. Labels

E3. Pre-Printed & Write-On Markers

E4. Permanent Identification

E5. Lockout/Tagout & Safety Solutions

F. Index

A. System Overview

B1. Cable Ties



Tubular Ring Terminal, Non-Insulated

Type S-R

- Seamless tubular barrel provides a consistent high performance quality crimp
- Round double thick tongue for reliable power applications
- Barrel of terminal internally beveled to provide quick and easy wire insertion
- Inspection window allows visual inspection of proper wire insertion
- UL and CSA rated up to 2000 V per UL 486A
- Maximum recommended operating temperature 302°F (150°C)

B3. Stainless Steel Ties



C1. Wiring Duct

C2. Surface Raceway

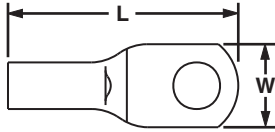

C3. Abrasion Protection

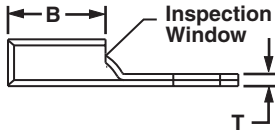

C4. Cable Management

D1. Terminals

Min. Tensile Strength of Tubular Ring Terminals			
#8	#6	#4	#2
90	100	140	180

D2. Power Connectors

D3. Grounding Connectors

E1. Labeling Systems

E2. Labels

E3. Pre-Printed & Write-On Markers

E4. Permanent Identification

E5. Lockout/Tagout & Safety Solutions

F. Index

Part Number	Wire Range	Stud Hole Size	Tongue Width W	Figure Dimensions (In.)			Recommended Installation Tool	Std. Pkg. Qty.*	Std. Ctn. Qty.
				L	B	T			
S8-10R-Q	8 AWG	#10	.41	1.10	.40	.08	CT-1700, CT-720, CT-930, CT-930CH, CT-940CH, CT-2001, CT-2002, CT-2931, CT-2940	25	250
S8-14R-Q		1/4"	.48	1.20	.40	.07		25	250
S8-56R-Q		5/16"	.60	1.30	.40	.05		25	250
S8-38R-Q		3/8"	.60	1.40	.40	.05		25	250
S6-10R-E	6 AWG	#10	.45	1.20	.48	.09		20	200
S6-14R-E		1/4"	.48	1.30	.48	.08		20	200
S6-56R-E		5/16"	.56	1.40	.48	.07		20	200
S6-38R-E	4 AWG	3/8"	.62	1.50	.48	.06		20	200
S4-10R-E		#10	.55	1.20	.48	.09		20	200
S4-14R-E		1/4"	.55	1.30	.48	.09		20	200
S4-56R-E		5/16"	.55	1.40	.48	.09		20	200
S4-38R-E	1 - 2 AWG	3/8"	.62	1.50	.48	.07		20	200
S2-10R-X		#10	.70	1.60	.59	.11	10	100	
S2-14R-X		1/4"	.70	1.60	.59	.11	10	100	
S2-56R-X		5/16"	.70	1.70	.59	.11	10	100	
S2-38R-X		3/8"	.70	1.70	.59	.11	10	100	
S2-12R-X	1/0 AWG	1/2"	.79	1.90	.59	.09	10	100	
S1/0-14R-X		1/4"	.76	1.60	.58	.12	10	100	
S1/0-56R-X		5/16"	.76	1.70	.58	.12	10	100	
S1/0-38R-X		3/8"	.76	1.70	.58	.12	10	100	
S1/0-12R-X		1/2"	.82	1.90	.58	.12	10	100	
S2/0-14R-X		2/0 AWG	1/4"	.85	1.90	.66	.13	10	100
S2/0-56R-X	5/16"		.85	1.90	.66	.13	10	100	
S2/0-38R-X	3/8"		.85	1.90	.66	.13	10	100	
S2/0-76R-X	7/16"		.85	2.10	.66	.13	10	100	
S2/0-12R-X	1/2"		.85	2.10	.66	.13	10	100	
S3/0-14R-5	3/0 AWG	1/4"	.96	2.10	.83	.13	CT-720, CT-930, CT-930CH, CT-940CH, CT-2001, CT-2002, CT-980, CT-2980, CT-980CH, CT-2931, CT-2940	5	50
S3/0-56R-5		5/16"	.96	2.10	.83	.13		5	50
S3/0-38R-5		3/8"	.96	2.10	.83	.13		5	50
S3/0-76R-5		7/16"	.96	2.30	.83	.13		5	50
S3/0-12R-5	4/0 AWG	1/2"	.96	2.30	.83	.13		5	50
S4/0-56R-5		5/16"	1.06	2.30	.91	.14		5	50
S4/0-38R-5		3/8"	1.06	2.30	.91	.14		5	50
S4/0-76R-5		7/16"	1.06	2.50	.91	.14		5	50
S4/0-12R-5		1/2"	1.06	2.50	.91	.14		5	50
S250-56R-5	250 kcmil	5/16"	1.17	2.50	1.01	.14		5	50
S250-38R-5		3/8"	1.17	2.50	1.01	.14		5	50
S250-76R-5		7/16"	1.17	2.60	1.01	.14		5	50
S250-12R-5		1/2"	1.17	2.60	1.01	.14	5	50	

For crimping tool information, see pages D1.84, D1.87, and D3.37 through D3.46.
*Contact PANDUIT Customer Service for bulk packaging.



Fork Terminal, Nylon Insulated

Type PN-F

- Fork design provides for fast and easy installation, without the need to remove fastener
- Metal insulation grip sleeve crimps to wire insulation, providing protection to the crimp joint during high vibration applications
- Internal barrel serrations assure good wire contact and maximum tensile strength
- UL Flammability UL 94V-2/HB, maximum insulation temperature 221°F (105°C)
- UL and CSA rated up to 600 V per UL 486



Part Number	Wire Range	Color Code	Stock Thickness	Max. Ins.	Stud Size	Figure Dimensions (In.)			Recommended Installation Tool	Std. Pkg. Qty.**	Std. Ctn. Qty.
						L	W	C			
PN22-2F-C*	26 – 22 AWG	Yellow	.02	.090	#2	.66	.20	.19	CT-100, CT-600-A, CT-1525, CT-2500	100	1000
PN22-4F-C*			.02	.090	#4	.67	.20	.21		100	1000
PN22-6F-C*			.02	.090	#6	.77	.25	.26		100	1000
PN18-6FN-C	22 – 18 AWG	Red	.03	.145	#6	.78	.24	.20	CT-100‡, CT-600-A‡, CT-1550‡, CT-1551‡, CT-2500‡	100	500
PN18-6F-C			.03	.145	#6	.78	.30	.20		100	500
PN18-8F-C			.03	.145	#8	.85	.32	.23		100	500
PN18-10FN-C			.03	.145	#10	.86	.31	.25		100	500
PN18-10F-C			.03	.145	#10	.86	.35	.25		100	500
PN18-14F-C			.03	.145	#10	1.03	.44	.33		100	500
PN14-6FN-C			18 – 14 AWG	Blue	.03	.162	#6	.79		.24	.19
PN14-6F-C	.03	.162			#6	.79	.28	.19	100	500	
PN14-8F-C	.03	.162			#8	.85	.31	.23	100	500	
PN14-10FN-C	.03	.162			#10	.87	.31	.24	100	500	
PN14-10F-C	.03	.162			#10	.87	.34	.24	100	500	
PN14-14F-C	.03	.162			#10	1.02	.44	.32	100	500	
PN10-6F-L	12 – 10 AWG	Yellow			.04	.225	#6	1.00	.31	.22	CT-100‡, CT-600-A‡, CT-1550‡, CT-1551‡, CT-2500‡
PN10-8F-L			.04	.225	#8	1.03	.37	.22	50	500	
PN10-10F-L			.04	.225	#10	1.04	.37	.22	50	500	
PN10-14F-L			.04	.225	#10	1.14	.49	.30	50	500	

*Not UL Listed or CSA Certified.

**To order in bulk, replace -C in the part number with -M for a bulk package of 1000 and replace -L with -D for a bulk package of 500.

‡UL and CSA approved tooling/product combinations. For crimping tool information, see pages D1.83, D1.84, D1.86 and D1.88.

A. System Overview

B1. Cable Ties

B2. Cable Accessories

B3. Stainless Steel Ties

C1. Wiring Duct

C2. Surface Raceway

C3. Abrasion Protection

C4. Cable Management

D1. Terminals

D2. Power Connectors

D3. Grounding Connectors

E1. Labeling Systems

E2. Labels

E3. Pre-Printed & Write-On Markers

E4. Permanent Identification

E5. Lockout/Tagout & Safety Solutions

F. Index

A. System Overview

B1. Cable Ties



Fork Terminal, Nylon Insulated – Funnel Entry

Type PNF-F

- Fork design provides for fast and easy installation, without the need to remove fastener
- Metal insulation grip sleeve crimps to wire insulation, providing protection to the crimp joint during high vibration applications
- Internal barrel serrations assure good wire contact and maximum tensile strength
- UL Flammability UL 94V-2/HB, maximum insulation temperature 221°F (105°C)
- UL and CSA rated up to 600 V per UL 486

B2. Cable Accessories

B3. Stainless Steel Ties



C1. Wiring Duct



C2. Surface Raceway



C3. Abrasion Protection



C4. Cable Management

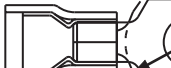

D1. Terminals



D2. Power Connectors



D3. Grounding Connectors



E1. Labeling Systems



E2. Labels



E3. Pre-Printed & Write-On Markers



E4. Permanent Identification



E5. Lockout/Tagout & Safety Solutions



F. Index

Part Number	Wire Range	Color Code	Stock Thickness	Max. Ins.	Stud Size	Figure Dimensions (In.)			Recommended Installation Tool	Std. Pkg. Qty.**	Std. Ctn. Qty.
						L	W	C			
PNF18-6F-C	22 – 18 AWG	Red	.03	.136	#6	.80	.30	.22	CT-100‡, CT-600-A‡, CT-1550‡, CT-1551‡, CT-2500‡	100	500
PNF18-8F-C			.03	.136	#8	.86	.31	.25			
PNF18-10F-C			.03	.136	#10	.87	.34	.26			
PNF18-14F-C			.03	.136	1/4"	1.05	.44	.35			
PNF14-6F-C	16 – 14 AWG	Blue	.03	.162	#6	.80	.28	.22	CT-100‡, CT-600-A‡, CT-1550‡, CT-1551‡, CT-2500‡	100	500
PNF14-8F-C			.03	.162	#8	.85	.31	.25			
PNF14-10F-C			.03	.162	#10	.87	.34	.26			
PNF14-14F-C			.03	.162	1/4"	1.05	.44	.35			
PNF10-6F-L	12 – 10 AWG	Yellow	.04	.225	#6	1.01	.31	.24	CT-100‡, CT-600-A‡, CT-1550‡, CT-1551‡, CT-2500‡	50	500
PNF10-8F-L			.04	.225	#8	1.02	.37	.24			
PNF10-10F-L			.04	.225	#10	1.04	.37	.24			
PNF10-14F-L			.04	.225	1/4"	1.15	.50	.31			

**To order in bulk, replace -C in the part number with -M for a bulk package of 1000 and replace -L with -D for a bulk package of 500.
 ‡UL and CSA approved tooling/product combinations. For crimping tool information, see pages D1.83, D1.84, D1.86 and D1.88.



Fork Terminal, Vinyl Insulated – Funnel Entry

Type PV-F

- Fork design provides for fast and easy installation, without the need to remove fastener
- Insulation support helps to prevent wire damage in bending applications
- Brazed seam protects terminal barrel from splitting during the crimp process
- UL Flammability UL 94V-0, maximum insulation temperature 221°F (105°C)
- Internal barrel serrations assure good wire contact and maximum tensile strength
- UL and CSA rated up to 600 V per UL 486

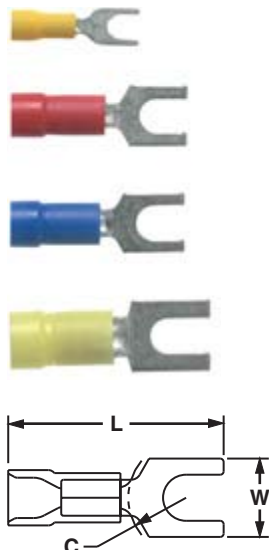

Part Number	Wire Range	Color Code	Stock Thickness	Max. Ins.	Stud Size	Figure Dimensions (In.)			Recommended Installation Tool	Std. Pkg. Qty.**	Std. Ctn. Qty.
						L	W	C			
PV22-2F-C*	26 – 22 AWG	Yellow	.02	.110	#2	.61	.20	.19	CT-100, CT-600-A, CT-1525, CT-2500	100	1000
PV22-4F-C*			.02	.110	#4	.67	.20	.21			
PV22-6F-C*			.02	.110	#6	.76	.25	.26			
PV18-6FN-CY*	22 – 16 AWG	Red	.03	.150	#6	.85	.24	.21	CT-100‡, CT-600-A‡, CT-1550‡, CT-1551‡, CT-2500‡	100	500
PV18-6F-CY			.03	.150	#6	.86	.30	.21			
PV18-8F-CY			.03	.150	#8	.93	.32	.25			
PV18-10FN-CY*			.03	.150	#10	.93	.31	.25			
PV18-10F-CY			.03	.150	#10	.93	.35	.25			
PV14-6FN-C			16 – 14 AWG	Blue	.03	.170	#6	.84			
PV14-6F-C	.03	.170			#6	.84	.28	.19			
PV14-8F-C	.03	.170			#8	.90	.31	.23			
PV14-10FN-C	.03	.170			#10	.92	.31	.24			
PV14-10F-C	.03	.170			#10	.92	.34	.24			
PV14-14F-C	.03	.170			1/4"	1.09	.44	.32			
PV10-6F-L	14 – 10 AWG	Yellow	.04	.225	#6	1.01	.31	.25	CT-100‡, CT-600-A‡, CT-1550‡, CT-1551‡, CT-2500‡	50	500
PV10-8F-L			.04	.225	#8	1.04	.37	.25			
PV10-10F-L			.04	.225	#10	1.04	.37	.25			
PV10-14F-L			.04	.225	1/4"	1.14	.49	.32			

*Not UL Listed or CSA Certified.

**To order in bulk, replace -C or -CY in the part number with -M or -MY for a bulk package of 1000 and replace -L with -D for a bulk package of 500.

‡UL and CSA approved tooling/product combinations. For crimping tool information, see pages D1.83, D1.84, D1.86 and D1.88.

A. System Overview

B1. Cable Ties

B2. Cable Accessories

B3. Stainless Steel Ties

C1. Wiring Duct

C2. Surface Raceway

C3. Abrasion Protection

C4. Cable Management

D1. Terminals

D2. Power Connectors

D3. Grounding Connectors

E1. Labeling Systems

E2. Labels

E3. Pre-Printed & Write-On Markers

E4. Permanent Identification

E5. Lockout/Tagout & Safety Solutions

F. Index

A. System Overview

B1. Cable Ties

B2. Cable Accessories

B3. Stainless Steel Ties

C1. Wiring Duct

C2. Surface Raceway

C3. Abrasion Protection

C4. Cable Management

D1. Terminals

D2. Power Connectors

D3. Grounding Connectors

E1. Labeling Systems

E2. Labels

E3. Pre-Printed & Write-On Markers

E4. Permanent Identification

E5. Lockout/Tagout & Safety Solutions

F. Index



Fork Terminal, Vinyl Insulated – Expanded Insulation

Type PV-FX

- Expanded wire entry designed to accommodate wire with a larger insulation thickness
- Fork design provides for fast and easy installation, without the need to remove fastener
- Insulation support helps to prevent wire damage in bending applications
- Brazed seam protects terminal barrel from splitting during the crimp process
- UL Flammability UL 94V-0, maximum insulation temperature 221°F (105°C)
- Internal barrel serrations assure good wire contact and maximum tensile strength
- UL and CSA rated up to 600 V per UL 486

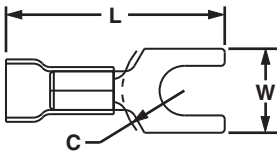

Part Number	Wire Range	Color Code	Stock Thickness	Max. Ins.	Stud Size	Figure Dimensions (In.)			Recommended Installation Tool	Std. Pkg. Qty.**	Std. Ctn. Qty.
						L	W	C			
PV18-6FX-CY	22 – 18 AWG	Red	.03	.170	#6	.83	.30	.21	CT-100‡, CT-600-A‡, CT-1550‡, CT-1551‡, CT-2500‡	100	500
PV18-8FX-CY			.03	.170	#8	.89	.32	.25			
PV18-10FX-CY			.03	.170	#10	.91	.35	.25			
PV14-6FX-C	18 – 14 AWG	Blue	.03	.200	#6	.89	.28	.16	CT-100‡, CT-600-A‡, CT-1550‡, CT-1551‡, CT-2500‡	100	500
PV14-8FX-C			.03	.200	#8	.96	.31	.20			
PV14-10FX-C			.03	.200	#10	.97	.34	.22			
PV10-8FX-L	12 – 10 AWG	Yellow	.04	.250	#8	1.11	.37	.24	CT-100‡, CT-600-A‡, CT-1550‡, CT-1551‡, CT-2500‡	50	500
PV10-10FX-L			.04	.250	#10	1.11	.37	.24			
PV10-14FX-L			.04	.250	1/4"	1.22	.50	.32			

**To order in bulk, replace -C or -CY in the part number with -M or -MY for a bulk package of 1000 and replace -L with -D for a bulk package of 500.

‡UL and CSA approved tooling/product combinations. For crimping tool information, see pages D1.83, D1.84, D1.86 and D1.88.



Locking Fork Terminal, Nylon Insulated

Type PN-LF

- Locks in place for secure connection
- Fork design provides for fast and easy installation, without the need to remove fastener
- Metal insulation grip sleeve crimps to wire insulation, providing protection to the crimp joint during high vibration applications
- Internal barrel serrations assure good wire contact and maximum tensile strength
- UL Flammability UL 94V-2/HB, maximum insulation temperature 221°F (105°C)
- UL and CSA rated up to 600 V per UL 486

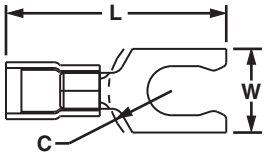

Part Number	Wire Range	Color Code	Stock Thickness	Max. Ins.	Stud Size	Figure Dimensions (In.)			Recommended Installation Tool	Std. Pkg. Qty.**	Std. Ctn. Qty.
						L	W	C			
PN18-6LF-C	22 – 18 AWG	Red	.03	.145	#6	.82	.27	.22	CT-100‡, CT-600-A‡, CT-1550‡, CT-1551‡, CT-2500‡	100	500
PN18-6LFW-C			.03	.145	#6	.85	.29	.22			
PN18-8LF-C			.03	.145	#8	.89	.29	.25			
PN18-10LF-C			.03	.145	#10	.89	.33	.25			
PN18-10LFN-C*			.03	.145	#10	.91	.29	.25			
PN14-6LF-C	18 – 14 AWG	Blue	.03	.162	#6	.86	.25	.22	CT-100‡, CT-600-A‡, CT-1550‡, CT-1551‡, CT-2500‡	100	500
PN14-6LFW-C			.03	.162	#6	.84	.29	.22			
PN14-8LF-C			.03	.162	#8	.92	.29	.25			
PN14-10LF-C			.03	.162	#10	.91	.33	.25			
PN14-10LFN-C	.03	.162	#10	.91	.28	.25	CT-100‡, CT-600-A‡, CT-1550‡, CT-1551‡, CT-2500‡	100	500		
PN10-6LF-L	12 – 10 AWG	Yellow	.04	.225	#6	1.02				.30	.23
PN10-8LF-L			.04	.225	#8	1.05				.30	.23
PN10-10LF-L			.04	.225	#10	1.05				.34	.23
PN10-14LF-L			.04	.225	1/4"	1.17	.46	.32			

*Not UL Listed or CSA Certified.

**To order in bulk, replace -C in the part number with -M for a bulk package of 1000 and replace -L with -D for a bulk package of 500.

‡UL and CSA approved tooling/product combinations. For crimping tool information, see pages D1.83, D1.84, D1.86 and D1.88.



Locking Fork Terminal, Nylon Insulated – Funnel Entry

Type PNF-LF

- Locks in place for secure connection
- Fork design provides for fast and easy installation, without the need to remove fastener
- Metal insulation grip sleeve crimps to wire insulation, providing protection to the crimp joint during high vibration applications

- Internal barrel serrations assure good wire contact and maximum tensile strength
- UL Flammability UL 94V-2/HB, maximum insulation temperature 221°F (105°C)
- UL and CSA rated up to 600 V per UL 486

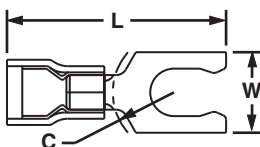

Part Number	Wire Range	Color Code	Stock Thickness	Max. Ins.	Stud Size	Figure Dimensions (In.)			Recommended Installation Tool	Std. Pkg. Qty.**	Std. Ctn. Qty.
						L	W	C			
PNF18-6LF-C	22 – 18 AWG	Red	.03	.145	#6	.82	.27	.20	CT-100‡, CT-600-A‡, CT-1550‡, CT-1551‡, CT-2500‡	100	500
PNF18-6LFW-C			.03	.145	#6	.85	.29	.20			
PNF18-8LF-C			.03	.145	#8	.89	.29	.26			
PNF18-10LF-C	18 – 14 AWG	Blue	.03	.145	#10	.89	.33	.25	CT-100‡, CT-600-A‡, CT-1550‡, CT-1551‡, CT-2500‡	100	500
PNF14-6LF-C			.03	.162	#6	.87	.25	.20			
PNF14-8LF-C			.03	.162	#8	.93	.29	.25			
PNF14-10LF-C	12 – 10 AWG	Yellow	.03	.162	#10	.93	.33	.25	CT-100‡, CT-600-A‡, CT-1550‡, CT-1551‡, CT-2500‡	100	500
PNF10-6LF-L			.04	.225	#6	1.02	.30	.20			
PNF10-8LF-L			.04	.225	#8	1.05	.30	.20			
PNF10-10LF-L			.04	.225	#10	1.05	.34	.22		50	500
PNF10-14LF-L			.04	.225	1/4"	1.19	.46	.33			

**To order in bulk, replace -C in the part number with -M for a bulk package of 1000 and replace -L with -D for a bulk package of 500.

‡UL and CSA approved tooling/product combinations. For crimping tool information, see pages D1.83, D1.84, D1.86 and D1.88.



Locking Fork Terminal, Vinyl Insulated – Funnel Entry

Type PV-LF

- Locks in place for secure connection
- Fork design provides for fast and easy installation, without the need to remove fastener
- Insulation support helps to prevent wire damage in bending applications

- UL Flammability UL 94V-0, maximum insulation temperature 221°F (105°C)
- Internal barrel serrations assure good wire contact and maximum tensile strength
- UL and CSA rated to 600 V per UL 486

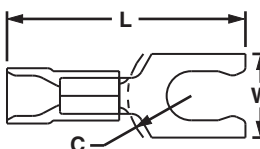

Part Number	Wire Range	Color Code	Stock Thickness	Max. Ins.	Stud Size	Figure Dimensions (In.)			Recommended Installation Tool	Std. Pkg. Qty.**	Std. Ctn. Qty.
						L	W	C			
PV18-6LF-CY	22 – 18 AWG	Red	.03	.150	#6	.90	.27	.22	CT-100‡, CT-600-A‡, CT-1550‡, CT-1551‡, CT-2500‡	100	500
PV18-6LFW-CY			.03	.150	#6	.90	.29	.22			
PV18-8LF-CY			.03	.150	#8	.97	.29	.25			
PV18-10LF-CY	18 – 14 AWG	Blue	.03	.150	#10	.97	.33	.25	CT-100‡, CT-600-A‡, CT-1550‡, CT-1551‡, CT-2500‡	100	500
PV18-10LFN-CY*			.03	.150	#10	.97	.29	.25			
PV14-6LF-C			.03	.170	#6	.90	.25	.22			
PV14-6LFW-C	12 – 10 AWG	Yellow	.03	.170	#6	.90	.29	.22	CT-100‡, CT-600-A‡, CT-1550‡, CT-1551‡, CT-2500‡	100	500
PV14-8LF-C			.03	.170	#8	.97	.29	.25			
PV14-10LF-C			.03	.170	#10	.97	.33	.25			
PV14-10LFN-C			.03	.170	#10	.97	.29	.25		100	500
PV10-6LF-L			.04	.225	#6	1.03	.30	.23			
PV10-8LF-L			.04	.225	#8	1.05	.30	.23			
PV10-10LF-L			.04	.225	#10	1.04	.34	.23		50	500
PV10-14LF-L			.04	.225	1/4"	1.19	.46	.36			

*Not UL Listed or CSA Certified.

**To order in bulk, replace -C or -CY in the part number with -M or -MY for a bulk package of 1000 and replace -L with -D for a bulk package of 500.

‡UL and CSA approved tooling/product combinations. For crimping tool information, see pages D1.83, D1.84, D1.86 and D1.88.

A. System Overview

B1. Cable Ties

B2. Cable Accessories

B3. Stainless Steel Ties

C1. Wiring Duct

C2. Surface Raceway

C3. Abrasion Protection

C4. Cable Management

D1. Terminals

D2. Power Connectors

D3. Grounding Connectors

E1. Labeling Systems

E2. Labels

E3. Pre-Printed & Write-On Markers

E4. Permanent Identification

E5. Lockout/Tagout & Safety Solutions

F. Index

A. System Overview

B1. Cable Ties

B2. Cable Accessories

B3. Stainless Steel Ties

C1. Wiring Duct

C2. Surface Raceway

C3. Abrasion Protection

C4. Cable Management

D1. Terminals

D2. Power Connectors

D3. Grounding Connectors

E1. Labeling Systems

E2. Labels

E3. Pre-Printed & Write-On Markers

E4. Permanent Identification

E5. Lockout/Tagout & Safety Solutions

F. Index



Locking Fork Terminal, Vinyl Insulated – Expanded Insulation

Type PV-LFX

- Expanded wire entry designed to accommodate wire with a larger insulation thickness
- Locks in place for secure connection
- Insulation support helps to prevent wire damage in bending applications
- Brazed seam protects terminal barrel from splitting during the crimp process
- UL Flammability UL 94V-0, maximum insulation temperature 221°F (105°C)
- Internal barrel serrations assure good wire contact and maximum tensile strength
- UL and CSA rated up to 600 V per UL 486

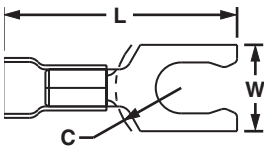

Part Number	Wire Range	Color Code	Stock Thickness	Max. Ins.	Stud Size	Figure Dimensions (In.)			Recommended Installation Tool	Std. Pkg. Qty.**	Std. Ctn. Qty.
						L	W	C			
PV18-6LFX-CY	22 – 16 AWG	Red	.03	.170	#6	.95	.27	.20	CT-100‡, CT-600-A‡, CT-1550‡, CT-1551‡, CT-2500‡	100	500
PV18-8LFX-CY			.03	.170	#8	1.01	.29	.20			
PV18-10LFX-CY			.03	.170	#10	1.04	.33	.23			
PV14-6LFX-C	18 – 14 AWG	Blue	.03	.200	#6	.95	.25	.20	CT-100‡, CT-600-A‡, CT-1550‡, CT-1551‡, CT-2500‡	100	500
PV14-8LFX-C			.03	.200	#8	1.01	.29	.23			
PV14-10LFX-C			.03	.200	#10	1.01	.33	.23			
PV10-6LFX-L	12 – 10 AWG	Yellow	.04	.250	#6	1.09	.30	.23	CT-100‡, CT-600-A‡, CT-1550‡, CT-1551‡, CT-2500‡	50	500
PV10-8LFX-L			.04	.250	#8	1.12	.30	.23			
PV10-10LFX-L			.04	.250	#10	1.12	.34	.23			
PV10-14LFX-L			.04	.250	1/4"	1.25	.46	.32		50	500

**To order in bulk, replace -C or -CY in the part number with -M or -MY for a bulk package of 1000 and replace -L with -D for a bulk package of 500.

‡UL and CSA approved tooling/product combinations. For crimping tool information, see pages D1.83, D1.84, D1.86 and D1.88.



Short Locking Fork Terminal, Nylon Insulated

Type PN-SLF

- Locks in place for a secure connection in limited spaces
- Fork design provides for fast and easy installation, without the need to remove fastener
- Metal insulation grip sleeve crimps to wire insulation, providing protection to the crimp joint during high vibration applications
- Internal barrel serrations assure good wire contact and maximum tensile strength
- UL Flammability UL 94V-2/HB, maximum insulation temperature 221°F (105°C)
- UL and CSA rated up to 600 V per UL 486

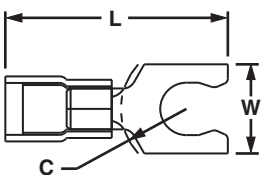

Part Number	Wire Range	Color Code	Stock Thickness	Max. Ins.	Stud Size	Figure Dimensions (In.)			Recommended Installation Tool	Std. Pkg. Qty.**	Std. Ctn. Qty.
						L	W	C			
PN18-5SLF-C	22 – 18 AWG	Red	.03	.145	#5	.75	.26	.19	CT-1550, CT-1551, CT-2500	100	500
PN18-6SLF-C			.03	.145	#6	.75	.27	.19			
PN18-8SLF-C			.03	.145	#8	.80	.29	.23			
PN18-10SLF-C			.03	.145	#10	.81	.33	.23			
PN14-5SLF-C	16 – 14 AWG	Blue	.03	.162	#5	.75	.25	.19	CT-1550, CT-1551, CT-2500	100	500
PN14-6SLF-C			.03	.162	#6	.75	.25	.19			
PN14-8SLF-C			.03	.162	#8	.80	.29	.23			
PN14-10SLF-C			.03	.162	#10	.81	.33	.23			
PN14-14SLF-C			.03	.162	1/4"	.90	.44	.28		100	500
PN10-5SLF-L	12 – 10 AWG	Yellow	.04	.225	#5	.86	.25	.22	CT-1550, CT-1551, CT-2500	50	500
PN10-6SLF-L			.04	.225	#6	.86	.25	.22			
PN10-8SLF-L			.04	.225	#8	.92	.29	.26			
PN10-10SLF-L			.04	.225	#10	.92	.33	.26			
PN10-14SLF-L			.04	.225	1/4"	1.01	.45	.33		50	500

**To order in bulk, replace -C in the part number with -M for a bulk package of 1000 and replace -L with -D for a bulk package of 500.

For crimping tool information, see pages D1.84 and D1.88.



Short Locking Fork Terminal, Nylon Insulated – Funnel Entry

Type PNF-SLF

- Locks in place for a secure connection in limited spaces
- Fork design provides for fast and easy installation, without the need to remove fastener
- Metal insulation grip sleeve crimps to wire insulation, providing protection to the crimp joint during high vibration applications
- Internal barrel serrations assure good wire contact and maximum tensile strength
- UL Flammability UL 94V-2/HB, maximum insulation temperature 221°F (105°C)
- UL and CSA rated up to 600 V per UL 486

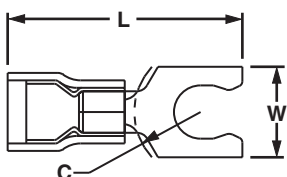

Part Number	Wire Range	Color Code	Stock Thickness	Max. Ins.	Stud Size	Figure Dimensions (In.)			Recommended Installation Tool	Std. Pkg. Qty.**	Std. Ctn. Qty.
						L	W	C			
PNF18-5SLF-C	22 – 18 AWG	Red	.03	.145	#5	.75	.26	.19	CT-1550, CT-1551, CT-2500	100	500
PNF18-6SLF-C			.03	.145	#6	.75	.27	.19			
PNF18-8SLF-C			.03	.145	#8	.80	.29	.23			
PNF18-10SLF-C			.03	.145	#10	.81	.33	.23			
PNF14-5SLF-C	16 – 14 AWG	Blue	.03	.162	#5	.75	.25	.19	CT-1550, CT-1551, CT-2500	100	500
PNF14-6SLF-C			.03	.162	#6	.75	.25	.19			
PNF14-8SLF-C			.03	.162	#8	.82	.29	.23			
PNF14-10SLF-C			.03	.162	#10	.81	.33	.23			
PNF14-14SLF-C			.03	.162	1/4"	.91	.44	.28		100	500
PNF10-6SLF-L	12 – 10 AWG	Yellow	.04	.225	#6	.91	.25	.17	CT-1550, CT-1551, CT-2500	50	500
PNF10-8SLF-L			.04	.225	#8	.92	.29	.22			
PNF10-10SLF-L			.04	.225	#10	.93	.33	.22			
PNF10-14SLF-L			.04	.225	1/4"	1.02	.45	.28			

**To order in bulk, replace -C in the part number with -M for a bulk package of 1000 and replace -L with -D for a bulk package of 500.

For crimping tool information, see pages D1.84 and D1.88.



Short Locking Fork Terminal, Vinyl Insulated – Funnel Entry

Type PV-SLF

- Locks in place for a secure connection in limited spaces
- Fork design provides for fast and easy installation, without the need to remove fastener
- Insulation support helps to prevent wire damage in bending applications
- Internal barrel serrations assure good wire contact and maximum tensile strength
- UL Flammability UL 94V-0, maximum insulation temperature 221°F (105°C)
- UL and CSA rated up to 600 V per UL 486

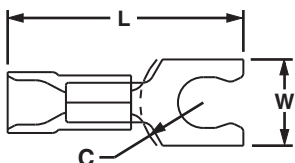

Part Number	Wire Range	Color Code	Stock Thickness	Max. Ins.	Stud Size	Figure Dimensions (In.)			Recommended Installation Tool	Std. Pkg. Qty.**	Std. Ctn. Qty.
						L	W	C			
PV18-5SLF-CY^	22 – 18 AWG	Red	.03	.150	#5	.82	.26	.19	CT-1550, CT-1551, CT-2500	100	500
PV18-6SLF-CY^			.03	.150	#6	.82	.27	.19			
PV18-8SLF-CY^			.03	.150	#8	.87	.29	.23			
PV18-10SLF-CY^			.03	.150	#10	.88	.33	.23			
PV14-5SLF-C*	16 – 14 AWG	Blue	.03	.175	#5	.80	.25	.22	CT-1550, CT-1551, CT-2500	100	1000
PV14-6SLF-C*			.03	.175	#6	.80	.25	.22			
PV14-8SLF-C*			.03	.175	#8	.85	.29	.26			
PV14-10SLF-C*			.03	.175	#10	.86	.33	.26			
PV14-14SLF-C*			.03	.175	1/4"	.95	.44	.33		100	1000
PV10-5SLF-L	12 – 10 AWG	Yellow	.04	.225	#5	.86	.25	.22	CT-1550, CT-1551, CT-2500	50	500
PV10-6SLF-L			.04	.225	#6	.87	.25	.22			
PV10-8SLF-L			.04	.225	#8	.92	.29	.26			
PV10-10SLF-L			.04	.225	#10	.92	.33	.26			
PV10-14SLF-L			.04	.225	1/4"	1.02	.45	.33			

*Not UL Listed or CSA Certified.

**To order in bulk, replace -C or -CY in the part number with -M or -MY for a bulk package of 1000 and replace -L with -D for a bulk package of 500.

For crimping tool information, see pages D1.84 and D1.88.

^CSA Certified only.

A. System Overview

B1. Cable Ties

B2. Cable Accessories

B3. Stainless Steel Ties

C1. Wiring Duct

C2. Surface Raceway

C3. Abrasion Protection

C4. Cable Management

D1. Terminals

D2. Power Connectors

D3. Grounding Connectors

E1. Labeling Systems

E2. Labels

E3. Pre-Printed & Write-On Markers

E4. Permanent Identification

E5. Lockout/Tagout & Safety Solutions

F. Index

A. System Overview

B1. Cable Ties

B2. Cable Accessories

B3. Stainless Steel Ties

C1. Wiring Duct

C2. Surface Raceway

C3. Abrasion Protection

C4. Cable Management

D1. Terminals

D2. Power Connectors

D3. Grounding Connectors

E1. Labeling Systems

E2. Labels

E3. Pre-Printed & Write-On Markers

E4. Permanent Identification

E5. Lockout/Tagout & Safety Solutions

F. Index



Flanged Fork Terminal, Nylon Insulated

Type PN-FF

- Flange design provides extra secure connection on a variety of applications
- Metal insulation grip sleeve crimps to wire insulation, providing protection to the crimp joint during high vibration applications
- Internal barrel serrations assure good wire contact and maximum tensile strength

- UL Flammability UL 94V-2/HB, maximum insulation temperature 221°F (105°C)
- UL and CSA rated up to 600 V per UL 486

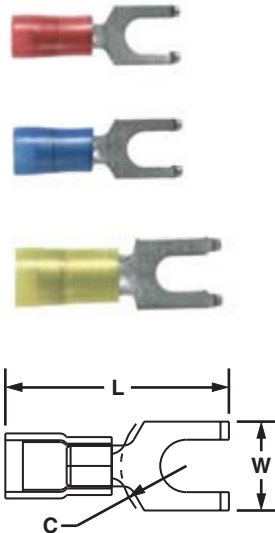

Part Number	Wire Range	Color Code	Stock Thickness	Max. Ins.	Stud Size	Figure Dimensions (In.)			Recommended Installation Tool	Std. Pkg. Qty.**	Std. Ctn. Qty.
						L	W	C			
PN18-6FF-C	22 – 16 AWG	Red	.03	.136	#6	.81	.28	.20	CT-100‡, CT-600-A‡, CT-1550‡, CT-1551‡, CT-2500‡	100	500
PN18-8FF-C			.03	.136	#8	.88	.31	.23			
PN18-10FF-C			.03	.136	#10	.86	.35	.23			
PN14-6FF-C	18 – 14 AWG	Blue	.03	.162	#6	.79	.28	.20	CT-100‡, CT-600-A‡, CT-1550‡, CT-1551‡, CT-2500‡	100	500
PN14-8FF-C			.03	.162	#8	.86	.31	.23			
PN14-10FF-C			.03	.162	#10	.86	.36	.23			
PN10-8FF-L	12 – 10 AWG	Yellow	.04	.225	#8	1.05	.37	.28	CT-100‡, CT-600-A‡, CT-1550‡, CT-1551‡, CT-2500‡	50	500
PN10-10FF-L			.04	.225	#10	1.05	.37	.28			

**To order in bulk, replace -C in the part number with -M for a bulk package of 1000 and replace -L with -D for a bulk package of 500.

‡UL and CSA approved tooling/product combinations. For crimping tool information, see pages D1.83, D1.84, D1.86 and D1.88.



Flanged Fork Terminal, Vinyl Insulated – Funnel Entry

Type PV-FF

- Flange design provides extra secure connection on a variety of applications
- Insulation support helps to prevent wire damage in bending applications
- Brazed seam protects terminal barrel from splitting during the crimp process

- UL Flammability UL 94V-0, maximum insulation temperature 221°F (105°C)
- Internal barrel serrations assure good wire contact and maximum tensile strength
- UL and CSA rated up to 600 V per UL 486

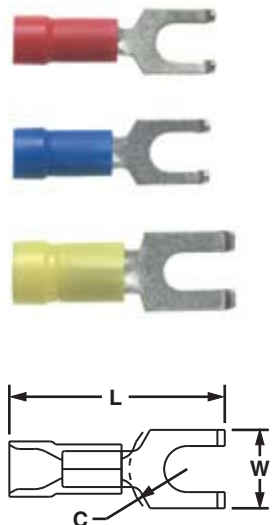

Part Number	Wire Range	Color Code	Stock Thickness	Max. Ins.	Stud Size	Figure Dimensions (In.)			Recommended Installation Tool	Std. Pkg. Qty.**	Std. Ctn. Qty.
						L	W	C			
PV18-6FF-CY	22 – 16 AWG	Red	.03	.150	#6	.87	.28	.19	CT-100‡, CT-600-A‡, CT-1550‡, CT-1551‡, CT-2500‡	100	500
PV18-8FF-CY			.03	.150	#8	.94	.31	.23			
PV18-10FF-CY			.03	.150	#10	.93	.35	.23			
PV14-6FF-C	16 – 14 AWG	Blue	.03	.165	#6	.88	.28	.19	CT-100‡, CT-600-A‡, CT-1550‡, CT-1551‡, CT-2500‡	100	500
PV14-8FF-C			.03	.165	#8	.94	.31	.23			
PV14-10FF-C			.03	.165	#10	.94	.35	.23			
PV10-8FF-L	14 – 10 AWG	Yellow	.04	.225	#8	1.03	.37	.22	CT-100‡, CT-600-A‡, CT-1550‡, CT-1551‡, CT-2500‡	50	500
PV10-10FF-L			.04	.225	#10	1.03	.37	.22			

**To order in bulk, replace -C or -CY in the part number with -M or -MY for a bulk package of 1000 and replace -L with -D for a bulk package of 500.

‡UL and CSA approved tooling/product combinations. For crimping tool information, see pages D1.83, D1.84, D1.86 and D1.88.



Fork Terminal, Non-Insulated

Type P-F

- Fork design provides for fast and easy installation, without the need to remove fastener
- Internal barrel serrations assure good wire contact and maximum tensile strength
- Brazed seam protects terminal barrel from splitting during the crimp process

- Barrel of terminal internally beveled to provide quick and easy wire insertion
- UL and CSA rated up to 2000 V per UL 486
- Maximum recommended operating temperature 302°F (150°C)

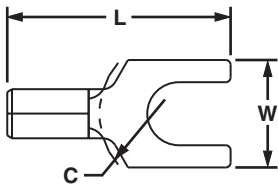

Part Number	Wire Range	Stock Thickness	Stud Size	Figure Dimensions (In.)			Recommended Installation Tool	Std. Pkg. Qty.**	Std. Ctn. Qty.
				L	W	C			
P22-2F-C*	26 – 22 AWG	.02	#2	.49	.19	.19	CT-100, CT-200	100	1000
P22-4F-C*		.02	#4	.49	.20	.19		100	1000
P22-6F-C*		.02	#6	.59	.25	.26		100	1000
P18-6FN-C*	22 – 16 AWG	.03	#6	.63	.24	.19	CT-100‡, CT-200‡, CT-600-A‡, CT-1570‡, CT-2500‡	100	1000
P18-6F-C		.03	#6	.63	.30	.21		100	1000
P18-8F-C		.03	#8	.69	.32	.25		100	1000
P18-10FN-C*		.03	#10	.71	.31	.25		100	1000
P18-10F-C		.03	#10	.71	.35	.25		100	1000
P18-14F-C		.03	1/4"	.88	.44	.33		100	1000
P14-6FN-C	18 – 14 AWG	.03	#6	.63	.24	.20	CT-100‡, CT-200‡, CT-600-A‡, CT-1570‡, CT-2500‡	100	1000
P14-6F-C		.03	#6	.63	.28	.20		100	1000
P14-8F-C		.03	#8	.69	.31	.23		100	1000
P14-10FN-C		.03	#10	.71	.31	.25		100	1000
P14-10F-C		.03	#10	.71	.34	.25		100	1000
P14-14F-C		.03	1/4"	.88	.44	.33		100	1000
P10-6F-L	12 – 10 AWG	.04	#6	.75	.31	.22	CT-100‡, CT-200‡, CT-600-A‡, CT-1570‡, CT-1701‡, CT-2500‡	50	500
P10-8F-L		.04	#8	.78	.37	.22		50	500
P10-10F-L		.04	#10	.78	.37	.23		50	500
P10-14F-L		.04	1/4"	.89	.50	.30		50	500

*Not UL Listed or CSA Certified.

**To order in bulk, replace -C in the part number with -M for a bulk package of 1000 and replace -L with -D for a bulk package of 500.

‡UL and CSA approved tooling/product combinations. For crimping tool information, see pages D1.83, D1.84, D1.86 and D1.88.

A. System Overview

B1. Cable Ties

B2. Cable Accessories

B3. Stainless Steel Ties

C1. Wiring Duct

C2. Surface Raceway

C3. Abrasion Protection

C4. Cable Management

D1. Terminals

D2. Power Connectors

D3. Grounding Connectors

E1. Labeling Systems

E2. Labels

E3. Pre-Printed & Write-On Markers

E4. Permanent Identification

E5. Lockout/Tagout & Safety Solutions

F. Index

A. System Overview

B1. Cable Ties



Flanged Fork Terminal, Non-Insulated

Type P-FF

- Flange design provides extra secure connection on a variety of applications
- Internal barrel serrations assure good wire contact and maximum tensile strength
- Brazed seam protects terminal barrel from splitting during the crimp process

- Barrel of terminal internally beveled to provide quick and easy wire insertion
- UL and CSA rated up to 2000 V per UL 486
- Maximum recommended operating temperature 302°F (150°C)

B2. Cable Accessories

B3. Stainless Steel Ties



C1. Wiring Duct



C2. Surface Raceway



C3. Abrasion Protection

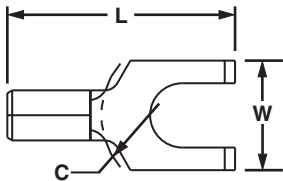

C4. Cable Management



Part Number	Wire Range	Stock Thickness	Stud Size	Figure Dimensions (In.)			Recommended Installation Tool	Std. Pkg. Qty.**	Std. Ctn. Qty.
				L	W	C			
P18-8FF-C	22 – 16 AWG	.03	#8	.72	.31	.25	CT-100‡, CT-200‡, CT-600-A‡, CT-1570‡, CT-2500‡	100	500
P14-6FF-C	16 – 14 AWG	.03	#6	.65	.28	.22		100	500
P14-8FF-C		.03	#8	.72	.31	.25		100	500
P10-10FF-L	12 – 10 AWG	.04	#10	.80	.38	.28	CT-100‡, CT-200‡, CT-600-A‡, CT-1570‡, CT-1701‡, CT-2500‡	50	500

**To order in bulk, replace -C in the part number with -M for a bulk package of 1000 and replace -L with -D for a bulk package of 500.

‡UL and CSA approved tooling/product combinations. For crimping tool information, see pages D1.83, D1.84, D1.86 and D1.88.

D1. Terminals



Locking Fork Terminal, Non-Insulated

Type P-LF

- Locks in place for secure connection
- Fork design provides for fast and easy installation, without the need to remove fastener
- Internal barrel serrations assure good wire contact and maximum tensile strength
- Brazed seam protects terminal barrel from splitting during the crimp process

- Barrel of terminal internally beveled to provide quick and easy wire insertion
- UL and CSA rated up to 2000 V per UL 486
- Maximum recommended operating temperature 302°F (150°C)

D2. Power Connectors

D3. Grounding Connectors



E1. Labeling Systems

E2. Labels

E3. Pre-Printed & Write-On Markers

E4. Permanent Identification

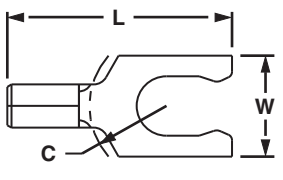

E5. Lockout/Tagout & Safety Solutions

Part Number	Wire Range	Stock Thickness	Stud Size	Figure Dimensions (In.)			Recommended Installation Tool	Std. Pkg. Qty.**	Std. Ctn. Qty.
				L	W	C			
P18-6LF-C	22 – 16 AWG	.03	#6	.68	.27	.22	CT-100‡, CT-200‡, CT-600-A‡, CT-1570‡, CT-2500‡	100	500
P18-6LFW-C		.03	#6	.70	.29	.22		100	500
P18-8LF-C		.03	#8	.74	.29	.23		100	500
P18-10LFN-C*		.03	#10	.74	.28	.23		100	500
P18-10LF-C		.03	#10	.74	.33	.23		100	500
P14-6LF-C	18 – 14 AWG	.03	#6	.70	.25	.22	CT-100‡, CT-200‡, CT-600-A‡, CT-1570‡, CT-2500‡	100	500
P14-6LFW-C		.03	#6	.70	.29	.22		100	500
P14-8LF-C		.03	#8	.77	.29	.27		100	500
P14-10LFN-C		.03	#10	.77	.29	.27		100	500
P14-10LF-C		.03	#10	.77	.33	.27		100	500
P10-6LF-L	14 – 10 AWG	.04	#6	.77	.30	.23	CT-100‡, CT-200‡, CT-600-A‡, CT-1570‡, CT-1701‡, CT-2500‡	50	500
P10-8LF-L		.04	#8	.79	.30	.23		50	500
P10-10LF-L		.04	#10	.79	.34	.23		50	500
P10-14LF-L		.04	1/4"	.92	.46	.33		50	500

*Not UL Listed or CSA Certified.

**To order in bulk, replace -C in the part number with -M for a bulk package of 1000 and replace -L with -D for a bulk package of 500.

‡UL and CSA approved tooling/product combinations. For crimping tool information, see pages D1.83, D1.84, D1.86 and D1.88.

UL LISTED CERTIFIED Short Locking Fork Terminal, Non-Insulated

Type P-SLF

- Locks in place for a secure connection in limited spaces
- Fork design provides for fast and easy installation, without the need to remove fastener
- Internal barrel serrations assure good wire contact and maximum tensile strength
- Brazed seam protects terminal barrel from splitting during the crimp process
- Barrel of terminal internally beveled to provide quick and easy wire insertion
- UL and CSA rated up to 2000 V per UL 486
- Maximum recommended operating temperature 302°F (150°C)

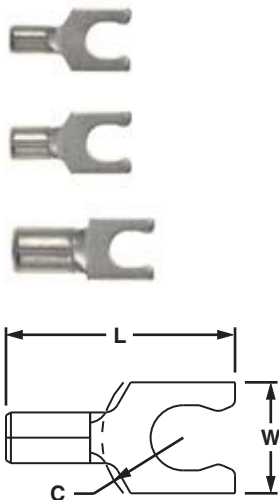

Part Number	Wire Range	Stock Thickness	Stud Size	Figure Dimensions (In.)			Recommended Installation Tool	Std. Pkg. Qty.**	Std. Ctn. Qty.
				L	W	C			
P18-6SLF-C	22 – 16 AWG	.03	#6	.51	.27	.22	CT-100‡, CT-200‡, CT-600-A‡, CT-1570‡, CT-2500‡	100	1000
P18-8SLF-C		.03	#8	.56	.29	.25		100	1000
P18-10SLF-C		.03	#10	.57	.33	.25		100	1000
P14-6SLF-C	16 – 14 AWG	.03	#6	.51	.25	.22	CT-100‡, CT-200‡, CT-600-A‡, CT-1570‡, CT-2500‡	100	1000
P14-8SLF-C		.03	#8	.56	.29	.25		100	1000
P14-10SLF-C		.03	#10	.57	.33	.25		100	1000
P14-14SLF-C		.03	1/4"	.66	.44	.35		100	1000
P10-5SLF-L	14 – 10 AWG	.04	#5	.60	.25	.19	CT-100‡, CT-200‡, CT-600-A‡, CT-1570‡, CT-1701‡, CT-2500‡	50	500
P10-8SLF-L		.04	#8	.66	.29	.23		50	500
P10-10SLF-L		.04	#10	.67	.33	.23		50	500
P10-14SLF-L		.04	1/4"	.76	.45	.28		50	500

**To order in bulk, replace -C in the part number with -M for a bulk package of 1000 and replace -L with -D for a bulk package of 500.

‡UL and CSA approved tooling/product combinations. For crimping tool information, see pages D1.83, D1.84, D1.86 and D1.88.

UL LISTED CERTIFIED Heat Shrink, Fork Terminal

Type PH-F

- Heat shrink polyolefin sleeve with hot melt adhesive protects against moisture
- Heat shrink sleeving forms a protective barrier to provide environmentally sealed terminations ideal for high moisture applications
- Fork design provides for fast and easy installation, without the need to remove fastener
- Brazed seam protects terminal barrel from splitting during the crimp process
- Heat shrink insulation is completed with a standard heat gun
- Minimum continuous operating temperature -65°F (-55°C)
- Maximum continuous operation temperature 230°F (110°C)
- Shrink temperature 250°F (120°C)



Part Number	Wire Range	Color Code	Max. Ins.	Stud Size	Figure Dimensions (In.)		Wire Strip Length	Recommended Installation Tool	Std. Pkg. Qty.	Std. Ctn. Qty.
					L	W				
PH18-6F-Q	22 – 18 AWG	Red	.170	#6	1.04	.32	5/16	CT-310	25	125
PH18-8F-Q			.170	#8	1.04	.32	5/16		25	125
PH18-10F-Q			.170	#10	1.04	.32	5/16		25	125
PH14-6F-Q	16 – 14 AWG	Blue	.190	#6	1.07	.38	5/16	CT-310	25	125
PH14-8F-Q			.190	#8	1.07	.38	5/16		25	125
PH14-10F-Q			.190	#10	1.07	.38	5/16		25	125
PH10-8F-E	12 – 10 AWG	Yellow	.240	#8	1.20	.38	5/16	CT-310	20	100
PH10-10F-E			.240	#10	1.20	.38	5/16		20	100

For crimping tool information, see page D1.85.

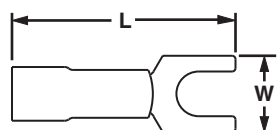

A. System Overview

B1. Cable Ties

B2. Cable Accessories

B3. Stainless Steel Ties

C1. Wiring Duct

C2. Surface Raceway

C3. Abrasion Protection

C4. Cable Management

D1. Terminals

D2. Power Connectors

D3. Grounding Connectors

E1. Labeling Systems

E2. Labels

E3. Pre-Printed & Write-On Markers

E4. Permanent Identification

E5. Lockout/Tagout & Safety Solutions

F. Index

A. System Overview

Features and Benefits – PAN-TERM® Metric Terminals

All PANDUIT terminals feature high quality materials made with electrolytic copper for high conductivity and are tin-plated for corrosion resistance.

B1. Cable Ties

B2. Cable Accessories

B3. Stainless Steel Ties

C1. Wiring Duct

C2. Surface Raceway

C3. Abrasion Protection

C4. Cable Management

Nylon Insulated Terminals with Insulation Grip Sleeve Type PMN or PMNF

Internal barrel serrations assure good wire contact and maximum tensile strength



Maximum insulation temperature 221°F (105°C)

Sleeved barrel assures crimp reliability

Insulation grip sleeve provides a superior insulation crimp for high vibration and high strain relief applications

Color-coded insulation identifies wire range

Funnel entry for faster insertion and lower installed cost

Rated up to 600 V per UL 486.

Flammability – UL 94V-21HB.

Proprietary blend of UL 094V-2 and UL 94HB flammability related materials.

Vinyl Insulated Terminals with Insulation Support Type PMV

Internal barrel serrations assure good wire contact and maximum tensile strength



Maximum insulation temperature 221°F (105°C)

Color-coded insulation identifies wire range

Brazed seam assures crimp reliability

Insulation crimp provides insulation support to protect electrical crimp

Funnel entry for faster insertion and lower installed cost

Rated up to 600 V per UL 486.

Flammability – UL 94V-0.

Non-Insulated Terminals Type PM

Product markings provide easy identification of wire size



Maximum recommended operating temperature 302°F (150°C)

Extended barrel length assures a good quality crimp and makes crimping easier

Internal barrel serrations assure good wire contact and maximum tensile strength

Brazed seam assures crimp reliability

Internally beveled barrel for quick easy wire insertion

Rated up to 2000 V per UL 486.

D1. Terminals

D2. Power Connectors

D3. Grounding Connectors

E1. Labeling Systems

E2. Labels

E3. Pre-Printed & Write-On Markers

E4. Permanent Identification

E5. Lockout/Tagout & Safety Solutions

F. Index



PANDUIT extensive line of tooling is specifically designed for optimum crimping performance.

See pages D1.83 – D1.88.



PANDUIT designs and manufactures a full line of labeling products, software, and printers to assist you with your labeling requirements.

See pages E1.1 – E2.30.

Part Number System for *PAN-TERM*® Metric Terminals

PM	V	1	—	3	R	B	—	C
Type	Insulation	Wire Range		Stud Size	Tongue Configuration	Special Configuration		Std. Pkg. Size
PM = <i>PAN-TERM</i> ® Metric	N = Nylon NF = Nylon Funnel V = Vinyl	1 = .5 – 1.0mm ² (22 – 18 AWG) 2 = 1.5 – 2.5mm ² (16 – 14 AWG) 6 = 4.0 – 6.0mm ² (12 – 10 AWG)	—	3 = M3 (#6) 4 = M4 (#8) 5 = M5 (#10) 6 = M6 (1/4) 8 = M8 (5/16)	R = Ring F = Fork	B = Butted Seam	—	X = 10 E = 20 Q = 25 L = 50 C = 100

Metric Ring Terminal, Nylon Insulated – Funnel Entry

Type PMNF-R

- Ring tongue design assures a secure connection in high vibration applications
- Metal insulation grip sleeve crimps to wire insulation, providing protection to the crimp joint during high vibration applications
- Internal barrel serrations assure good wire contact and maximum tensile strength
- Maximum insulation temperature 221°F (105°C)

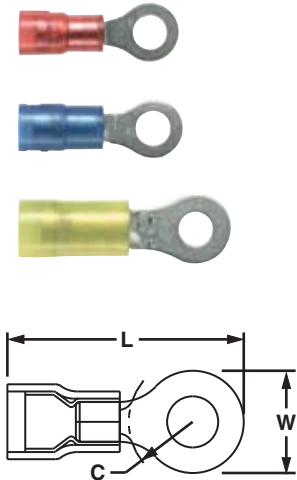

Part Number	Wire Range (mm ²)	Color Code	Max. Ins.	Stud Size	Figure Dimensions (mm)			Recommended Installation Tool	Std. Pkg. Qty.	Std. Ctn. Qty.
					L	W	C			
PMNF1-3R-C	.5 – 1.5	Red	3.76	M3	19.3	5.8	5.3	CT-1550, CT-2500	100	500
PMNF1-4R-C			3.76	M4	21.6	7.9	6.4		100	500
PMNF1-5R-C			3.76	M5	21.8	8.9	6.4		100	500
PMNF1-6R-C			3.76	M6	26.7	10.9	9.7		100	500
PMNF2-3R-C	1.5 – 2.5	Blue	4.11	M3	19.4	5.9	4.8	CT-1550, CT-2500	100	500
PMNF2-4R-C			4.11	M4	21.8	7.9	7.4		100	500
PMNF2-5R-C			4.11	M5	22.4	8.9	7.4		100	500
PMNF2-6R-C			4.11	M6	26.5	10.9	10.7		100	500
PMNF6-3R-L	2.5 – 6.0	Yellow	5.94	M3	26.7	5.8	9.1	CT-1550, CT-2500	50	250
PMNF6-4R-L			5.94	M4	27.4	7.9	9.1		50	250
PMNF6-5R-L			5.94	M5	28.5	9.7	9.1		50	250
PMNF6-6R-L			5.94	M6	30.2	10.9	10.9		50	250
PMNF6-8R-L			5.94	M8	31.5	13.2	10.9		50	250

For crimping tool information, see pages D1.84 and D1.88.

A. System Overview

B1. Cable Ties

B2. Cable Accessories

B3. Stainless Steel Ties

C1. Wiring Duct

C2. Surface Raceway

C3. Abrasion Protection

C4. Cable Management

D1. Terminals

D2. Power Connectors

D3. Grounding Connectors

E1. Labeling Systems

E2. Labels

E3. Pre-Printed & Write-On Markers

E4. Permanent Identification

E5. Lockout/Tagout & Safety Solutions

F. Index

A. System Overview

Metric Ring Terminal, Vinyl Insulated – Funnel Entry

B1. Cable Ties

Type PMV-R

- Ring tongue design assures a secure connection in high vibration applications
- Insulation support helps to prevent wire damage in bending applications
- Brazed seam protects terminal barrel from splitting during the crimp process
- Internal barrel serrations assure good wire contact and maximum tensile strength
- Maximum insulation temperature 221°F (105°C)

B2. Cable Accessories

B3. Stainless Steel Ties



C1. Wiring Duct



C2. Surface Raceway



C3. Abrasion Protection

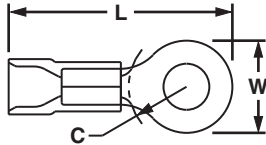

C4. Cable Management

Part Number	Wire Range (mm ²)	Color Code	Max. Ins.	Stud Size	Figure Dimensions (mm)			Recommended Installation Tool	Std. Pkg. Qty.	Std. Ctn. Qty.
					L	W	C			
PMV1-3RB-CY	.5 – 1.5	Red	4.01	M3	20.8	5.8	5.6	CT-1550, CT-2500	100	500
PMV1-4RB-CY			4.01	M4	23.1	7.9	7.4		100	500
PMV1-5RB-CY			4.01	M5	23.1	8.9	7.4		100	500
PMV1-6RB-CY			4.01	M6	28.2	10.9	10.7		100	500
PMV2-3RB-C	1.5 – 2.5	Blue	4.70	M3	20.5	5.8	6.4	CT-1550, CT-2500	100	500
PMV2-4RB-C			4.70	M4	23.1	7.9	6.4		100	500
PMV2-5RB-C			4.70	M5	23.8	8.9	6.4		100	500
PMV2-6RB-C			4.70	M6	25.7	10.9	9.7		100	500
PMV6-3R-L	2.5 – 6.0	Yellow	6.10	M3	26.1	5.8	7.9	CT-1550, CT-2500	50	250
PMV6-4R-L			6.10	M4	26.5	7.9	7.9		50	250
PMV6-5R-L			6.10	M5	27.1	9.5	7.9		50	250
PMV6-6R-L			6.10	M6	30.3	10.9	9.7		50	250
PMV6-8R-L			6.10	M8	31.4	13.2	9.7		50	250

For crimping tool information, see page D1.84 and D1.88.

D1. Terminals

Metric Ring Terminal, Non-Insulated

D2. Power Connectors

Type PM-R

- Ring tongue design assures a secure connection in high vibration applications
- Internal barrel serrations assure good wire contact and maximum tensile strength
- Brazed seam protects terminal barrel from splitting during the crimp process
- Barrel of terminal internally beveled to provide quick and easy wire insertion
- Maximum recommended operating temperature 302°F (150°C)

D3. Grounding Connectors

E1. Labeling Systems



E2. Labels



E3. Pre-Printed & Write-On Markers



E4. Permanent Identification

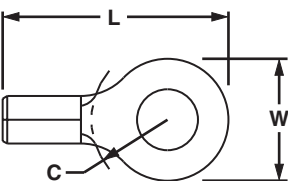

E5. Lockout/Tagout & Safety Solutions

F. Index

Part Number	Wire Range (mm ²)	Stud Size	Figure Dimensions (mm)			Recommended Installation Tool	Std. Pkg. Qty.	Std. Ctn. Qty.
			L	W	C			
PM1-3R-C	.5 – 1.5	M3	15.8	5.8	5.6	CT-1570, CT-2500	100	500
PM1-4R-C		M4	18.0	7.9	7.4		100	500
PM1-5R-C		M5	18.0	8.9	7.4		100	500
PM2-3R-C	1.5 – 2.5	M3	15.8	5.8	5.6	CT-1570, CT-2500	100	500
PM2-4R-C		M4	18.0	7.9	7.4		100	500
PM2-5R-C		M5	18.0	8.9	7.4		100	500
PM6-3R-L	2.5 – 6.0	M3	19.2	5.8	7.9	CT-1570, CT-2500	50	250
PM6-4R-L		M4	19.8	7.9	7.9		50	250
PM6-5R-L		M5	20.6	9.5	7.9		50	250
PM6-6R-L		M6	23.5	10.9	9.7		50	250
PM6-8R-L		M8	24.7	13.3	9.7		50	250

For crimping tool information, see pages D1.84 and D1.88.

Metric Fork Terminal, Nylon Insulated – Funnel Entry

Type PMNF-F

- Fork design provides for fast and easy installation, without the need to remove fastener
- Metal insulation grip sleeve crimps to wire insulation, providing protection to the crimp joint during high vibration applications
- Internal barrel serrations assure good wire contact and maximum tensile strength
- Maximum insulation temperature 221°F (105°C)

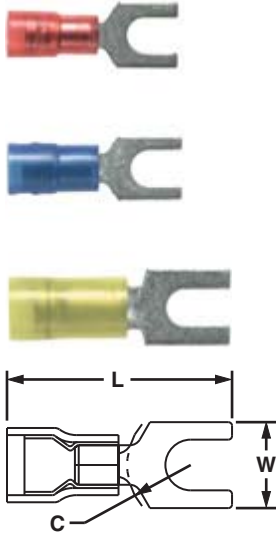

Part Number	Wire Range (mm²)	Color Code	Max. Ins.	Stud Size	Figure Dimensions (mm)			Recommended Installation Tool	Std. Pkg. Qty.	Std. Ctn. Qty.
					L	W	C			
PMNF1-3F-C	.5 – 1.5	Red	3.76	M3	21.1	5.9	5.1	CT-1550, CT-2500	100	500
PMNF1-4F-C			3.76	M4	22.6	8.1	5.8		100	500
PMNF1-5F-C			3.76	M5	22.9	8.9	6.4		100	500
PMNF1-6F-C			3.76	M6	27.4	11.2	8.4		100	500
PMNF2-3F-C	1.5 – 2.5	Blue	4.11	M3	19.8	5.9	5.1	CT-1550, CT-2500	100	500
PMNF2-4F-C			4.11	M4	21.3	7.9	5.9		100	500
PMNF2-5F-C			4.11	M5	21.9	8.6	6.4		100	500
PMNF2-6F-C			4.11	M6	26.2	11.2	8.5		100	500
PMNF6-4F-L	2.5 – 6.0	Yellow	5.94	M4	27.2	7.9	6.2	CT-1550, CT-2500	50	250
PMNF6-5F-L			5.94	M5	26.9	9.5	6.2		50	250
PMNF6-6F-L			5.94	M6	29.0	11.0	8.2		50	250

For crimping tool information, see pages D1.84 and D1.88.

Metric Fork Terminal, Vinyl Insulated – Funnel Entry

Type PMV-F

- Ring tongue design assures a secure connection in high vibration applications
- Insulation support helps to prevent wire damage in bending applications
- Brazed seam protects terminal barrel from splitting during the crimp process
- Internal barrel serrations assure good wire contact and maximum tensile strength
- Maximum insulation temperature 221°F (105°C)

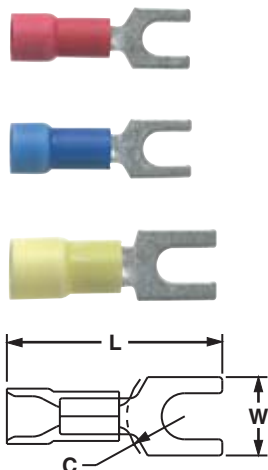

Part Number	Wire Range (mm²)	Color Code	Max. Ins.	Stud Size	Figure Dimensions (mm)			Recommended Installation Tool	Std. Pkg. Qty.	Std. Ctn. Qty.
					L	W	C			
PMV1-3FB-CY	.5 – 1.5	Red	4.01	M3	21.6	5.8	4.8	CT-1550, CT-2500	100	500
PMV1-4FB-CY			4.01	M4	23.1	8.1	5.8		100	500
PMV1-5FB-CY			4.01	M5	23.6	9.1	6.1		100	500
PMV1-6FB-CY			4.01	M6	27.9	11.2	8.1		100	500
PMV2-3FB-C	1.5 – 2.5	Blue	4.70	M3	21.3	5.8	4.8	CT-1550, CT-2500	100	500
PMV2-4FB-C			4.70	M4	22.9	7.9	5.8		100	500
PMV2-5FB-C			4.70	M5	23.4	8.6	6.1		100	500
PMV2-6FB-C			4.70	M6	27.7	11.2	8.1		100	500
PMV6-4F-L	2.5 – 6.0	Yellow	6.10	M4	26.4	8.1	5.6	CT-1550, CT-2500	50	250
PMV6-5F-L			6.10	M5	26.4	9.7	5.6		50	250
PMV6-6F-L			6.10	M6	29.5	10.9	8.1		50	250

For crimping tool information, see pages D1.84 and D1.88.

A. System Overview

B1. Cable Ties

B2. Cable Accessories

B3. Stainless Steel Ties

C1. Wiring Duct

C2. Surface Raceway

C3. Abrasion Protection

C4. Cable Management

D1. Terminals

D2. Power Connectors

D3. Grounding Connectors

E1. Labeling Systems

E2. Labels

E3. Pre-Printed & Write-On Markers

E4. Permanent Identification

E5. Lockout/Tagout & Safety Solutions

F. Index

A. System Overview

Metric Fork Terminal, Non-Insulated

B1. Cable Ties

Type PM-F

- Fork design provides for fast and easy installation, without the need to remove fastener
- Internal barrel serrations assure good wire contact and maximum tensile strength
- Brazed seam protects terminal barrel from splitting during the crimp process
- Barrel of terminal internally beveled to provide quick and easy wire insertion
- Maximum recommended operating temperature 302°F (150°C)

B2. Cable Accessories

B3. Stainless Steel Ties



C1. Wiring Duct

C2. Surface Raceway

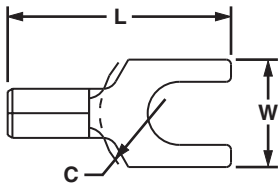

C3. Abrasion Protection

C4. Cable Management

Part Number	Wire Range (mm ²)	Stud Size	Figure Dimensions (mm)			Recommended Installation Tool	Std. Pkg. Qty.	Std. Ctn. Qty.
			L	W	C			
PM1-3F-C	.5 – 1.5	M3	16.0	5.8	5.6	CT-1570, CT-2500	100	500
PM1-4F-C		M4	17.5	8.1	6.4		100	500
PM1-5F-C		M5	18.0	8.8	6.6		100	500
PM2-3F-C	1.5 – 2.5	M3	16.0	5.8	5.6	CT-1570, CT-2500	100	500
PM2-4F-C		M4	17.5	7.9	6.4		100	500
PM2-5F-C		M5	18.0	8.6	6.9		100	500
PM6-5F-L	2.5 – 6.0	M5	19.4	9.5	7.1	CT-1570, CT-2500	50	250
PM6-6F-L		M6	22.6	10.9	8.6		50	250

For crimping tool information, see pages D1.84 and D1.88.

D1. Terminals

Plastic Box Terminal Kits

- Ideal for maintenance and construction wiring
- Positive latching case prevents accidental opening
- With the case top closed, parts remain in their compartments
- Case features a hanging tab for storage

D2. Power Connectors

D3. Grounding Connectors



KP-1075Y



KP-1165Y

E1. Labeling Systems

E2. Labels

E3. Pre-Printed & Write-On Markers

E4. Permanent Identification

E5. Lockout/Tagout & Safety Solutions

F. Index

Part Number	Part Description	Std. Pkg. Qty.
KP-1075Y	Terminal kit without crimping tool. Includes the following: (20) PV18-8R; PV18-6F; PV14-8F; PV14-10R; (10) PV10-8R; PV10-10R; DNF14-250; DNF18-250; BSV18X; BSV14X; BSV10X; (5) JN418-212.	1
KP-1000	Empty plastic box, twelve terminal compartments and one tool compartment, measures 11" wide x 6 3/4" deep x 1 3/4" high. Positive latch prevents accidental opening. Once top is closed, terminals remain in their compartments.	1
KP-1165Y	Includes the following: (18) PV18-8R; PV14-10R; PV18-6F; PV14-8F; (10) PV10-8R; PV10-10R; BSV18X; BSV14X; BSV10X; DV18-250B; DV14-188B; (5) JN418-212; (1) CT-160 tool; KP-1000 box.	1
KP-1166	Includes the following: (18) P18-8R; P14-10R; P18-6F; P14-8F; (10) P10-8R; P10-10R; BS18; BS14; BS10; D18-250; D14-188; (5) JN218-216; (1) CT-160 tool; KP-1000 box.	1

Steel Kit Boxes

- Latch prevents accidental opening
- Once lid is closed, terminals remain in their compartments
- Handle for portability or as drawer pull when used in rack



- Drop-in label area on front measures: 2.13"H x 13.75"W x 9.75"D (54.0mm x 349.3mm x 247.7mm)

Part Number	Part Description	Std. Pkg. Qty.
K-1000	Empty steel box, 20 terminal compartments and one tool compartment, dimensions: 2.00"H x 13.33"W x 9.33"D (50.8mm x 338.6mm x 237.0mm).	1
K-1001	Empty steel kit box, 15 terminal compartments and two tool compartments, box dimensions: 2.00"H x 13.33"W x 9.33"D (50.8mm x 338.6mm x 237.0mm).	1
K-1100	Steel box and CT-100 crimping tool.	1
K-1102Y	Includes the following: (100) PV18-6LF; PV18-8LF; PV14-8LF; PV14-10LF; BSV18X; BSV14X; (50) PV10-10LF; BSV10X; (1) CT-100 tool; K-1000 box.	1
K-1103Y	Includes the following: (100) DV18-250B; DV14-250B; DV14-250MB; D18-250; D14-250; (50) DV10-250; D10-250; (1) CT-100 tool; K-1000 box.	1
K-1104	Includes the following: (50) PN18-10R; PN14-6R; PN14-10R; PN18-6F; PN14-6F; PN14-10F; (25) PN10-10R; PN10-56R; PN10-10F; BSN14; BSN10; JN418-212; (1) CT-100 tool; K-1000 box.	1

Steel Slide Racks

- Steel boxes for cable tie kits and K-1000 terminal kits
- Steel boxes, storage slide racks, and base can be combined for neat and organized storage of cable ties and terminals

- Rugged and durable steel construction
- Empty boxes, full kits, slide racks and base are purchased according to your application needs



Part Number	Part Description	Std. Pkg. Qty.
SR2	2-drawer slide rack to hold K-504 cable tie kit or K-1000 series terminal kit. Dimensions: 6.25"H x 15.25"W x 11.75"D (158.7mm x 387.4mm x 298.5mm)	1
SR4	4-drawer slide rack to hold K-1000 series terminal kit. Dimensions: 11.25"H x 15.25"W x 11.75"D (285.8mm x 387.4mm x 298.5mm)	1
SR6	6-drawer slide rack to hold K-1000 series terminal kit. Dimensions: 16.38"H x 15.25"W x 11.75"D (416.1mm x 387.4mm x 298.5mm)	1

Base and slide racks are sold separately.

Slide racks will accommodate the following PANDUIT kits:	
K-1000	K-1103Y
K-1001	K-1104
K-1100	K1-PNKIT
K-1102Y	K2-PVKITY

A. System Overview

B1. Cable Ties

B2. Cable Accessories

B3. Stainless Steel Ties

C1. Wiring Duct

C2. Surface Raceway

C3. Abrasion Protection

C4. Cable Management

D1. Terminals

D2. Power Connectors

D3. Grounding Connectors

E1. Labeling Systems

E2. Labels

E3. Pre-Printed & Write-On Markers

E4. Permanent Identification

E5. Lockout/Tagout & Safety Solutions

F. Index

A.
System
Overview

Industrial Maintenance Kits

B1.
Cable Ties

- Steel kits have individual compartments for storage of terminals
- Once top is closed, terminals remain in their compartments
- Convenient carrying handle

B2.
Cable
Accessories

B3.
Stainless
Steel Ties

C1.
Wiring
Duct

C2.
Surface
Raceway

C3.
Abrasion
Protection

C4.
Cable
Management

D1.
Terminals

D2.
Power
Connectors

D3.
Grounding
Connectors

E1.
Labeling
Systems

E2.
Labels

E3.
Pre-Printed
& Write-On
Markers

E4.
Permanent
Identification

E5.
Lockout/
Tagout/
& Safety
Solutions

F.
Index



K1-PNKIT



K2-PVKITY



K-205

Part Number	Part Description	Std. Pkg. Qty.
K1-PNKIT	<p>Kit contains:</p> <ul style="list-style-type: none"> (1) K-1001 steel kit box (1) CT-260 installation tool <p><u>Cable Ties</u></p> <ul style="list-style-type: none"> (100) PLT2S cable ties <p><u>Terminals</u></p> <ul style="list-style-type: none"> (100) PN14-610R multi-stud terminals (100) PN18-610R multi-stud terminals (100) PN18-6LF locking fork terminals (100) PN14-8LF locking fork terminals (50) PN10-10LF locking fork terminals (100) PN18-8F fork terminals (100) PN14-10R ring terminals (50) PN10-10R ring terminals <p><u>Disconnects</u></p> <ul style="list-style-type: none"> (100) DNF18-250 disconnects (100) DNF14-250 disconnects (50) DV10-250 disconnects <p><u>Splices</u></p> <ul style="list-style-type: none"> (50) BSN18 butt splices (50) BSN14 butt splices (25) BSN10 butt splices <p><u>Marking System</u></p> <ul style="list-style-type: none"> (1) PMD-0-9 marking dispenser and tape (100) MP150 marker tags (1) PX-0 marker 	1
K2-PVKITY	<p>Kit contains:</p> <ul style="list-style-type: none"> (1) K-1001 steel kit box (1) CT-260 installation tool <p><u>Cable Ties</u></p> <ul style="list-style-type: none"> (100) PLT2S cable ties <p><u>Terminals</u></p> <ul style="list-style-type: none"> (100) PV18-8F fork terminals (100) PV18-6LF locking fork terminals (100) PV14-8LF locking fork terminals (50) PV10-10LF locking fork terminals (100) PV18-610R multi-stud terminals (100) PV14-10R ring terminals (50) PV10-10R ring terminals <p><u>Disconnects</u></p> <ul style="list-style-type: none"> (100) DNF18-250 disconnects (100) DV14-250B disconnects (50) DV10-250 disconnects <p><u>Splices</u></p> <ul style="list-style-type: none"> (50) BSV18X butt splices (50) BSV14X butt splices (25) BSV10X butt splices <p><u>Wire Joints</u></p> <ul style="list-style-type: none"> (30) JN224-318 (15) JN314-412 <p><u>Marking System</u></p> <ul style="list-style-type: none"> (1) PMD-0-9 marking dispenser and tape 	1
K-205*	<p>Kit for Indoor Use</p> <p>PAN-Ty® Cable Ties, cable tie installation tool, terminals, splices and crimp tool:</p> <ul style="list-style-type: none"> (1) GTS tool (1) CT-100 crimp tool <p><u>Natural Nylon 6.6 Cable Ties</u></p> <ul style="list-style-type: none"> (100) PLT1M (100) PLT1.5I (100) PLT2S <p><u>Terminals</u></p> <ul style="list-style-type: none"> (100) PV18-6LF (100) PV14-8LF (100) PV14-10LF (50) PV10-10LF <p><u>Splices</u></p> <ul style="list-style-type: none"> (50) BSV10X (100) BSV14X (100) BSV18X 	1

*The K-205 does not fit into the SR2, SR4, or SR6.

PAN-TERM® DISCONNECTS

PANDUIT® PAN-TERM® Disconnects are designed and precision made to function as a reliable method of making quick, repeatable interconnections. Available with nylon, premium nylon, vinyl insulation or non-insulated.



- Fully insulated design provides excellent protection from electrical shorts and provides additional installer protection for safety from electrical shocks
- Funnel entry speeds insertion and minimizes turned back wire strands
- Integrated metal insulation grip provides double crimp insulation grip for high vibration or conductor strain environments on select SUPRA-GRIP™ Disconnects and DISCO-LOK™ Disconnects and DISCOGRIP™ Disconnects
- Applicable sizes are UL Listed and CSA Certified, as noted
- Wide assortment of manual, controlled cycle, battery operated hydraulic and pneumatic crimping tools for reliable connections at the lowest installed cost

PANDUIT continually provides new designs to meet the application challenges encountered by our customers. PANDUIT offers a wide assortment of PAN-TERM® termination products at the lowest installed cost.

A.
System
Overview

B1.
Cable Ties

B2.
Cable
Accessories

B3.
Stainless
Steel Ties

C1.
Wiring
Duct

C2.
Surface
Raceway

C3.
Abrasion
Protection

C4.
Cable
Management

D1.
Terminals

D2.
Power
Connectors

D3.
Grounding
Connectors

E1.
Labeling
Systems

E2.
Labels

E3.
Pre-Printed
& Write-On
Markers

E4.
Permanent
Identification

E5.
Lockout/
Tagout/
& Safety
Solutions

F.
Index

A. System Overview

Features and Benefits – PAN-TERM® Disconnects

PAN-TERM® Disconnects are fabricated from brass and are electro tin-plated for a long, corrosion resistant operating life.

B1. Cable Ties

B2. Cable Accessories

B3. Stainless Steel Ties

C1. Wiring Duct

C2. Surface Raceway

C3. Abrasion Protection

C4. Cable Management

Nylon Fully Insulated Female Receptacles and Male Tabs Type DNF-FIB

Available in tab sizes to accommodate .110", .187", .205" or .250" tabs

Fully insulated design provides protection from electrical shorts

Expanded wire entry (on select sizes) accommodates large insulation or multiple wires

Maximum insulation temperature 257°F (125°C)

Insulation support restricts excessive wire movement to minimize stress on crimp joint

Funnel entry for faster wire insertion and lower installed cost



UL and CSA rated up to 600 V per UL 310.

DISCO-GRIP™ Premium Nylon Fully Insulated Female Receptacles and Male Tabs Type DNF and DPF

Available in tab sizes to accommodate .110", .187", .205" or .250" tabs

Fully insulated design provides protection from electrical shorts

Maximum insulation temperature 221°F (105°C)

Funnel entry for faster wire insertion and lower installed cost



UL and CSA rated up to 600 V per UL 310.

Male products available .250" width in standard and oversized housing configurations.

D1. Terminals

D2. Power Connectors

D3. Grounding Connectors

E1. Labeling Systems

E2. Labels

E3. Pre-Printed & Write-On Markers

E4. Permanent Identification

E5. Lockout/Tagout & Safety Solutions

F. Index

SUPRA-GRIP™ Nylon Fully Insulated Female Disconnects Type DNG-FB

Available in tab sizes to accommodate .187" or .250" tabs

Fully insulated design provides protection from electrical shorts

Maximum insulation temperature 221°F (105°C)

Funnel entry for faster wire insertion and lower installed cost

Fully integrated metal insulation grip for high vibration, high strain relief, and double crimp requirements



UL and CSA rated up to 600 V per UL 310.

DISCO-LOK™ Nylon Fully Insulated Locking Female Disconnects Type DNG-FL

Available in tab sizes to accommodate .250" tabs

Unique locking mechanism allows for low insertion forces (mating) and positive locking for secure connections

Maximum insulation temperature 221°F (105°C)

Funnel entry for faster wire insertion and lower installed cost

Insulation grip sleeve provides a superior insulation crimp for high vibration and high strain relief applications



UL and CSA rated up to 300 V.



PANDUIT extensive line of tooling is specifically designed for optimum crimping performance.

See pages D1.83 – D1.88.



PANDUIT designs and manufactures a full line of labeling products, software, and printers to assist you with your labeling requirements.

See pages E1.1 – E2.30.

Features and Benefits – PAN-TERM® Disconnects (continued)

Nylon Barrel Insulated Female Receptacles and Male Tabs Type DNF

Available in tab sizes to accommodate .110", .187", .205" or .250" tabs

Maximum insulation temperature 221°F (105°C)

Funnel entry for faster wire insertion and lower installed cost

Insulation grip sleeve provides a superior insulation crimp for high vibration and high strain relief applications



UL and CSA rated up to 300 V.
Male products available .250" width.

Vinyl Barrel Insulated Female Receptacles and Male Tabs Type DV and DVF

Available in tab sizes to accommodate .187", .205", or .250" tabs

Maximum insulation temperature 221°F (105°C)

Insulation support to protect electrical crimp

Insulation grip sleeve provides a superior insulation crimp for high vibration and high strain relief applications



UL and CSA rated up to 600 V.
Male products available .250" width.
Flammability – UL 94V-0.

Non-Insulated Female Receptacles and Male Tabs Type D

Available in tab sizes to accommodate .187" or .250" tabs

Sleeved barrel assures crimp reliability

Maximum recommended operating temperature 302°F (150°C)



Male products available .250" width.

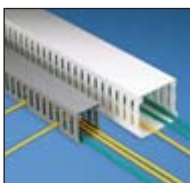

PANDUIT wiring duct offers a wide variety of sizes and types to meet the wire capacity needs and space constraints of the smallest wall mounted to the largest integrated systems.

See pages C1.1 – C1.52.



A comprehensive selection of cable ties used to bundle, mount, and identify wire and cable.

See pages B1.1 – B1.122.

A. System Overview

B1. Cable Ties

B2. Cable Accessories

B3. Stainless Steel Ties

C1. Wiring Duct

C2. Surface Raceway

C3. Abrasion Protection

C4. Cable Management

D1. Terminals

D2. Power Connectors

D3. Grounding Connectors

E1. Labeling Systems

E2. Labels

E3. Pre-Printed & Write-On Markers

E4. Permanent Identification

E5. Lockout/ Tagout & Safety Solutions

F. Index

A. System Overview

Selection Guide – PAN-TERM® Disconnects

B1. Cable Ties

B2. Cable Accessories

B3. Stainless Steel Ties

C1. Wiring Duct

C2. Surface Raceway

C3. Abrasion Protection

C4. Cable Management

D1. Terminals

D2. Power Connectors

D3. Grounding Connectors

E1. Labeling Systems

E2. Labels

E3. Pre-Printed & Write-On Markers

E4. Permanent Identification

E5. Lockout/Tagout & Safety Solutions

F. Index

Material	Style	Design	Feature	Type	Page Number
Nylon	Fully Insulated	Female	Funnel Entry, Ins. Grip	DNG-FB	D1.43
		Female	Funnel, Ins. Grip, Locking	DNG-FL	D1.44
		Female	Funnel, Ins. Support, Two-Pc.	DNF-FIB	D1.45
		Female	Funnel, Ins. Support, Three-Pc.	DNF-FI	D1.45
		Female	Funnel Entry, Premium Nylon	DPF-FIB	D1.46
		Male	Funnel, Ins. Support, Two-Pc.	DNF-FIM	D1.44
		Male	Premium Nylon	DPF-FIM	D1.46
		Female Right Angle	Funnel Entry, Ins. Support	DNFR-FIB	D1.49
		Female Right Angle	Funnel Entry, Open Top	DNFR-B	D1.50
		Nylon	Barrel Insulated	Female	Funnel Entry, Ins. Grip
Male	Funnel Entry, Ins. Grip			DNF-M	D1.52
Vinyl	Barrel Insulated	Female	Funnel Entry, Ins. Grip, Three-Pc.	DVF	D1.48
		Female	Funnel Entry, Butted Seam, Two-Pc.	DV-B	D1.48
		Male	Funnel Entry, Butted Seam, Two-Pc.	DV-MB	D1.52
		Piggyback	Funnel Entry, Ins. Grip	DV-P	D1.51
Heat Shrink	Fully Insulated	Female	Heat Shrink Insulated	DNH-FIB	D1.47
		Male	Heat Shrink Insulated	DNH-FIM	D1.47
Non-Insulated		Female	Sleeved Barrel	D	D1.49
		Female Right Angle	Sleeved Barrel	DR	D1.50
		Female Right Angle	Butted Seam	DR-B	D1.51
		Male	Butted Seam	D-MB	D1.53
		Adapter	Two Female to One Male	D-A	D1.51

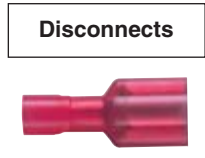

Part Number System for *PAN-TERM*® Disconnects

D	NF	—	14	250	FIB	—	M
Type	Insulation		Wire Range	Tab Size	Special Configuration		Standard Package Size
D = Disconnects	N = Nylon		18 = #22 – 18	110 = .110 x .032	A = Adapter		L = 50
	NF = Nylon, Funnel Entry		14 = #16 – 14	111 = .110 x .020	B = Butted Seam		C = 100
	NFR = Nylon, Funnel Entry, Right Angle		10 = #12 – 10	145 = .145 x .032	FB = Metal Insulation Grip, Female		D = 500
	NG = Nylon, Funnel Entry, Metal Insulation Grip			187 = .187 x .032	FI = Fully Insulated, Female		M = 1000
				188 = .187 x .020	FIB = Fully Insulated, Butted Seam, Female		
				205 = .187/.205 x .032	FIM = Fully Insulated, Male		
	PF = Premium Grade Nylon, Funnel Entry			206 = .187/.205 x .020	FIMB = Fully Insulated, Male with Oversized Housing		
	R = Non-insulated, Right Angle			250 = .250 x .032	FL = Locking, Metal Insulation Grip, Female		
	V = Vinyl				M = Male		
	= Non-Insulated (leave blank)				= Female (leave blank)		
					P = Piggyback		

UL LISTED CERTIFIED SUPRA-GRIP™ Female Disconnect, Nylon Fully Insulated – Funnel Entry

Type DNG-FB

- Disconnect can be inserted and removed from the male tab without the use of tools for lower installed cost
- Flared barrel extension integrated into stamping to provide insulation grip for double crimp requirements
- Internal barrel serrations assure good wire contact and maximum tensile strength
- Internal wire stop assures proper length of insertion into terminal barrel, providing a higher-quality connection
- Mates with DNF-FIMB Family

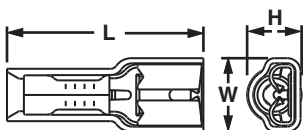

Part Number	Wire Range	Color Code	Max. Ins.	Figure Dimensions (In.)			Tab Size	Recommended Installation Tool	Std. Pkg. Qty.**	Std. Ctn. Qty.
				L	W	H				
DNG18-187FB-C	22 – 18 AWG	Red	.126	.89	.29	.22	.187 x .032	CT-1015	100	1000
DNG18-188FB-C			.126	.89	.29	.22	.187 x .020		100	1000
DNG18-250FB-C			.126	.93	.35	.22	.250 x .032		100	1000
DNG14-187FB-C*	16 – 14 AWG	Blue	.153	.89	.29	.25	.187 x .032	CT-1015	100	1000
DNG14-188FB-C*			.153	.89	.29	.25	.187 x .020		100	1000
DNG14-250FB-C			.153	.93	.35	.25	.250 x .032		100	1000

*UL Recognized for use with copper alloy tabs.

**To order in bulk, replace -C in the part number with -M for a bulk package of 1000.

For crimping tool information, see page D1.84.

A. System Overview

B1. Cable Ties

B2. Cable Accessories

B3. Stainless Steel Ties

C1. Wiring Duct

C2. Surface Raceway

C3. Abrasion Protection

C4. Cable Management

D1. Terminals

D2. Power Connectors

D3. Grounding Connectors

E1. Labeling Systems

E2. Labels

E3. Pre-Printed & Write-On Markers

E4. Permanent Identification

E5. Lockout/Tagout & Safety Solutions

F. Index

A. System Overview

Disco-Lok™ Female Disconnect, Nylon Fully Insulated – Funnel Entry

Type DNG-FL

- Disconnect can be inserted and removed from the male tab without the use of tools for lower installed cost
- Unique locking mechanism design allows for low insertion forces (mating) and positive lock for high vibration applications where a secure connection is mandatory
- Fully insulated design provides protection from electrical shorts
- Flared barrel extension integrated into stamping to provide insulation grip for double crimp requirements
- Insulation housing moves back and forth to engage and disengage locking mechanism for repeated use.
- Specialty tool required to install this disconnect (CT-1014)
- Mates with DNF-FIMB family

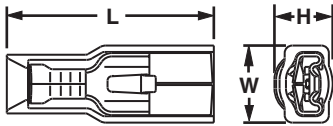

Part Number	Wire Range	Color Code	Max. Ins.	Figure Dimensions (In.)			Tab Size	Recommended Installation Tool	Std. Pkg. Qty.**	Std. Ctn. Qty.
				L	W	H				
DNG18-250FL-C	22–18 AWG	Red	.126	.97	.36	.24	.250 x .032	CT-1014	100	1000
DNG14-250FL-C	16–14 AWG	Blue	.150	.97	.36	.25	.250 x .032	CT-1014	100	1000

**To order in bulk, replace -C in the part number with -M for a bulk package of 1000. For crimping tool information, see page D1.84.

B1. Cable Ties

B2. Cable Accessories

B3. Stainless Steel Ties

C1. Wiring Duct

C2. Surface Raceway

C3. Abrasion Protection

C4. Cable Management



Male/Female Coupler, Nylon Fully Insulated – Funnel Entry

Type DNF

- Disconnect can be inserted and removed from the male tab without the use of tools for lower installed cost
- Fully insulated design provides protection from electrical shorts
- Metal insulation grip sleeve crimps to wire insulation, providing protection to the crimp joint during high vibration applications
- Internal barrel serrations assure good wire contact and maximum tensile strength
- Internal wire stop assures proper length of insertion into terminal barrel, providing a higher quality connection
- UL Flammability UL 94V-2/HB, maximum insulation temperature 221°F (105°C)
- Coupler, male, and female parts sold separately

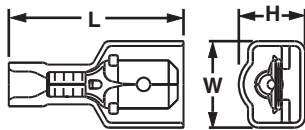

MALE

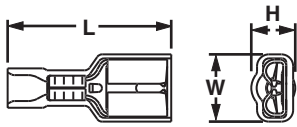

FEMALE

Part Number	Wire Range	Color Code	Max. Ins.	Figure Dimensions (In.)			Tab Size	Recommended Installation Tool	Std. Pkg. Qty.**	Std. Ctn. Qty.
				L	W	H				
DNF18-250FIM-C Male	22 – 18 AWG	Red	.133	.90	.42	.27	.250 x .032	CT-100‡, CT-600-A, CT-1525‡, CT-2500‡	100	1000
DNF18-250FIMB-L Male			.136	.91	.45	.34	.250 x .032		50	500
DNF18-250FIB-C Female			.136	.84	.35	.22	.250 x .032	CT-100, CT-600-A, CT-1525‡, CT-2500‡	100	1000
DNF14-250FIM-C Male	16 – 14 AWG	Blue	.158	.90	.42	.27	.250 x .032	CT-600-A, CT-1525‡, CT-2500‡	100	1000
DNF14-250FIMB-L Male			.160	.91	.45	.34	.250 x .032		50	500
DNF14-250FIB-C Female			.160	.84	.35	.22	.250 x .032	CT-100, CT-600-A, CT-1525‡, CT-2500‡	100	1000
DNF10-250FIMB-L Male	12 – 10 AWG	Yellow	.220	.96	.45	.36	.250 x .032	CT-600-A‡, CT-1550‡, CT-1551‡, CT-2500‡	50	500
DNF10-250FI-L Female			.220	.95	.36	.27	.250 x .032		CT-100‡, CT-600-A‡, CT-1550‡, CT-1551‡, CT-2500‡	50

**To order in bulk, replace -C in the part number with -M for a bulk package of 1000 and replace -L with -D for a bulk package of 500.

‡UL and CSA approved tooling/product combinations. For crimping tool information, see pages D1.83, D1.84, D1.86 and D1.88.



Female Disconnect,, Nylon Fully Insulated – Funnel Entry

Type DNF-FIB

- Disconnect can be inserted and removed from the male tab without the use of tools for lower installed cost
- Premium nylon insulation retains its shape when crimped and provides a tight grip around the wire insulation for maximum strain relief
- Fully insulated design provides protection from electrical shorts
- Internal wire stop assures proper length of insertion into terminal barrel, providing a higher quality connection
- Disconnects available in common industry tab sizes
- UL and CSA rated up to 600 V per UL 310



Part Number	Wire Range	Color Code	Max. Ins.	Figure Dimensions (In.)			Tab Size	Recommended Installation Tool	Std. Pkg. Qty.**	Std. Ctn. Qty.
				L	W	H				
DNF18-110FIB-C	22 – 18 AWG	Red	.120	.71	.19	.16	.110 x .032	CT-100, CT-600-A, CT-1525‡, CT-2500‡	100	1000
DNF18-111FIB-C			.120	.71	.19	.16	.110 x .020		100	1000
DNF18-187FIB-C			.136	.78	.29	.16	.187 x .032		100	1000
DNF18-188FIB-C			.136	.78	.29	.16	.187 x .020		100	1000
DNF18-205FIB-C			.136	.78	.31	.22	.205/.187 x .032		100	1000
DNF18-206FIB-C			.136	.78	.31	.22	.205/.187 x .020		100	1000
DNF18-250FIB-C	16 – 14 AWG	Blue	.136	.84	.35	.22	.250 x .032	CT-100, CT-600-A, CT-1525‡, CT-2500‡	100	1000
DNF14-187FIB-C			.160	.78	.29	.18	.187 x .032		100	1000
DNF14-188FIB-C			.160	.78	.29	.18	.187 x .020		100	1000
DNF14-205FIB-C			.160	.78	.31	.22	.205/.187 x .032		100	1000
DNF14-206FIB-C			.160	.78	.31	.22	.205/.187 x .020		100	1000
DNF14-250FIB-C	12 – 10 AWG	Yellow	.160	.84	.35	.22	.250 x .032	CT-1525‡, CT-2500‡	100	1000
DNF10-250FIB-L			.220	.96	.35	.23	.250 x .032		50	500

**To order in bulk, replace -C in the part number with -M for a bulk package of 1000 and replace -L with -D for a bulk package of 500.

‡UL and CSA approved tooling/product combinations. For crimping tool information, see pages D1.83, D1.84, D1.86 and D1.88.



Female Disconnect, Nylon Fully Insulated – Funnel Entry, Metal Collar

Type DNF-FI

- Disconnect can be inserted and removed from the male tab without the use of tools for lower installed cost
- Fully insulated design provides protection from electrical shorts
- Internal wire stop assures proper length of insertion into terminal barrel, providing a higher quality connection
- Barrel design with larger outside diameter for use with more common hand tools
- UL and CSA rated up to 600 V per UL 310

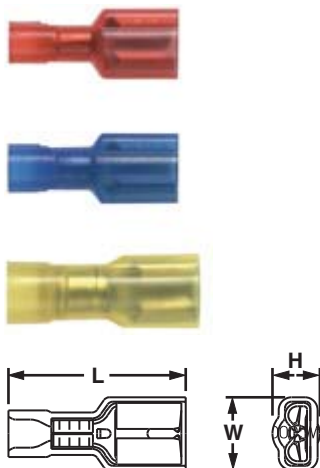

Part Number	Wire Range	Color Code	Max. Ins.	Figure Dimensions (In.)			Tab Size	Recommended Installation Tool	Std. Pkg. Qty.**	Std. Ctn. Qty.
				L	W	H				
DNF18-250FI-C	22 – 18 AWG	Red	.140	.94	.36	.21	.250 x .032	CT-100, CT-600-A, CT-1550, CT-1551, CT-2500	100	1000
DNF14-250FI-C	16 – 14 AWG	Blue	.160	.94	.36	.24	.250 x .032		100	1000
DNF10-250FI-L	12 – 10 AWG	Yellow	.220	.95	.36	.27	.250 x .032	CT-100‡, CT-600-A‡, CT-1550‡, CT-1551‡, CT-2500‡	50	500

**To order in bulk, replace -C in the part number with -M for a bulk package of 1000 and replace -L with -D for a bulk package of 500.

‡UL and CSA approved tooling/product combination. For crimping tool information, see pages D1.83, D1.84, D1.86 and D1.88.

A. System Overview

B1. Cable Ties

B2. Cable Accessories

B3. Stainless Steel Ties

C1. Wiring Duct

C2. Surface Raceway

C3. Abrasion Protection

C4. Cable Management

D1. Terminals

D2. Power Connectors

D3. Grounding Connectors

E1. Labeling Systems

E2. Labels

E3. Pre-Printed & Write-On Markers

E4. Permanent Identification

E5. Lockout/Tagout & Safety Solutions

F. Index

A. System Overview

B1. Cable Ties

B2. Cable Accessories

B3. Stainless Steel Ties

C1. Wiring Duct

C2. Surface Raceway

C3. Abrasion Protection

C4. Cable Management

D1. Terminals

D2. Power Connectors

D3. Grounding Connectors

E1. Labeling Systems

E2. Labels

E3. Pre-Printed & Write-On Markers

E4. Permanent Identification

E5. Lockout/Tagout & Safety Solutions

F. Index



DISCOGRIP™ Male Disconnect, Premium Nylon Fully Insulated – Funnel Entry

Type DPF-FIM

- Disconnect can be inserted and removed from the male tab without the use of tools for lower installed cost
- Premium nylon insulation retains its shape when crimped and provides a tight grip around the wire insulation for maximum strain relief
- Fully insulated design provides protection from electrical shorts
- Oversized housing designed for maximum versatility to mate with most commercially available fully insulated female disconnects
- Internal wire stop assures proper length of insertion into terminal barrel, providing a higher quality connection
- UL and CSA rated up to 600 V per UL 310

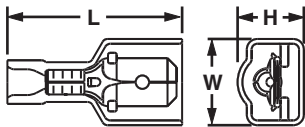

Part Number	Wire Range	Color Code	Max. Ins.	Figure Dimensions (In.)			Tab Size	Recommended Installation Tool	Std. Pkg. Qty.**	Std. Ctn. Qty.
				L	W	H				
DPF18-250FIM-C	22 – 18 AWG	Red	.133	.90	.41	.29	.250 x .032	CT-600-A, CT-1525, CT-2500	100	1000
DPF14-250FIM-C	16 – 14 AWG	Blue	.156	.90	.41	.29	.250 x .032		100	1000
DPF18-250FIMB-L*	22 – 18 AWG	Red	.133	.92	.46	.34	.250 x .032		50	500
DPF14-250FIMB-L*	16 – 14 AWG	Blue	.156	.92	.46	.34	.250 x .032		50	500

*Oversized housing design will mate with receptacles up to .390" wide and .235" (.285" high for parts with orientation bump).

**To order in bulk, replace -C in the part number with -M for a bulk package of 1000 and replace -L with -D for a bulk package of 500.

For crimping tool information, see pages D1.84, D1.86, and D1.88.



DISCOGRIP™ Female Disconnect, Premium Nylon Fully Insulated – Funnel Entry

Type DPF-FIB

- Disconnect can be inserted and removed from the male tab without the use of tools for lower installed cost
- Premium nylon insulation retains its shape when crimped and provides a tight grip around the wire insulation for maximum strain relief
- Fully insulated design provides protection from electrical shorts
- Internal wire stop assures proper length of insertion into terminal barrel, providing a higher quality connection
- Disconnects available in common industry tab sizes
- UL and CSA rated up to 600 V per UL 310

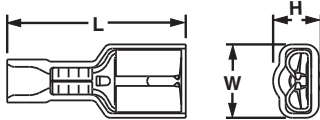

Part Number	Wire Range	Color Code	Max. Ins.	Figure Dimensions (In.)			Tab Size	Recommended Installation Tool	Std. Pkg. Qty.**	Std. Ctn. Qty.
				L	W	H				
DPF18-110FIB-C	22 – 18 AWG	Red	.132	.71	.19	.16	.110 x .032	CT-600-A‡, CT-1525‡, CT-2500‡	100	1000
DPF18-111FIB-C			.132	.71	.19	.16	.110 x .020		100	1000
DPF18-205FIB-C			.133	.78	.31	.22	.205/.187 x .032		100	1000
DPF18-206FIB-C			.133	.78	.31	.22	.205/.187 x .020		100	1000
DPF18-250FIB-C			.133	.84	.35	.22	.250 x .032		100	1000
DPF14-205FIB-C	16 – 14 AWG	Blue	.156	.78	.31	.22	.205/.187 x .032	CT-600-A‡, CT-1525‡, CT-2500‡	100	1000
DPF14-206FIB-C			.156	.78	.31	.22	.205/.187 x .020		100	1000
DPF14-250FIB-C			.156	.84	.35	.22	.250 x .032		100	1000
DPF10-250FI-L*	12 – 10 AWG	Yellow	.218	.95	.36	.27	.250 x .032	CT-600-A‡, CT-1525‡, CT-2500‡	50	500
DPF10-250FIB-L			.220	.96	.35	.23	.250 x .032		50	500

*Not UL listed or CSA approved.

**To order in bulk, replace -C in the part number with -M for a bulk package of 1000 and replace -L with -D for a bulk package of 500.

‡UL and CSA approved tooling/product combinations. For crimping tool information, see pages D1.84, D1.86, and D1.88.

Heat Shrink Disconnects, Fully Insulated – Funnel Entry

Type DNH

- Disconnect can be inserted and removed from the male tab without the use of tools for lower installed cost
- Heat shrink polyolefin sleeve with hot melt adhesive protects against moisture
- Heat shrink sleeving forms a protective barrier to provide environmentally sealed terminations ideal for high moisture applications
- Heat shrink sleeving provides additional level of strain relief for the wire
- Minimum continuous operating temperature -65°F (-55°C)
- Maximum continuous operation temperature 230°F (110°C)
- Shrink temperature 250°F (120°C)

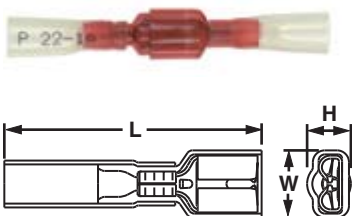

Part Number	Wire Range	Color Code	Max. Ins.	Figure Dimensions (In.)			Type	Wire Strip Length	Recommended Installation Tool	Std. Pkg. Qty.	Std. Ctn. Qty.
				L	W	H					
DNH18-250FIM-Q	22 – 18 AWG	Red	.133	1.50	.41	.31	Male	5/16	CT-310	25	125
DNH18-250FIB-Q			.132	1.44	.35	.22	Female				
DNH14-250FIM-Q	16 – 14 AWG	Blue	.158	1.50	.41	.31	Male			25	125
DNH14-250FIB-Q			.156	1.44	.35	.22	Female				
DNH10-250FI-E	12 – 10 AWG	Yellow	.230	1.44	.35	.27	Female			20	100

For crimping tool information, see page D1.85.

Female Disconnect, Nylon Barrel Insulated – Funnel Entry

Type DNF

- Disconnect can be inserted and removed from the male tab without the use of tools for lower installed cost
- Fully insulated design provides protection from electrical shorts
- Metal insulation grip sleeve crimps to wire insulation, providing protection to the crimp joint during high vibration applications
- Internal barrel serrations assure good wire contact and maximum tensile strength
- Internal wire stop assures proper length of insertion into terminal barrel, providing a higher quality connection
- UL Flammability UL 94V-2/HB, maximum insulation temperature 194°F (90°C)

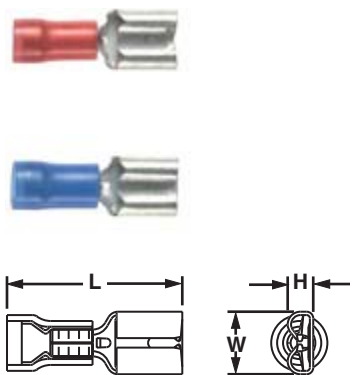

Part Number	Wire Range	Color Code	Max. Ins.	Figure Dimensions (In.)			Tab Size	Recommended Installation Tool	Std. Pkg. Qty.**	Std. Ctn. Qty.		
				L	W	H						
DNF18-110-C	22 – 18 AWG	Red	.100	.69	.15	.08	.110 x .032	CT-600-A‡, CT-1525‡, CT-2500‡	100	500		
DNF18-111-C			.100	.69	.15	.07	.110 x .020					
DNF18-187-C			.137	.76	.23	.10	.187 x .032	CT-600-A‡, CT-1550, CT-1551, CT-2500	100	500		
DNF18-188-C			.137	.76	.23	.10	.187 x .020					
DNF18-205-C			.137	.76	.25	.12	.205/.187 x .032					
DNF18-206-C			.137	.76	.25	.12	.205/.187 x .020					
DNF18-250-C			.138	.81	.29	.12	.250 x .032					
DNF14-110-C*			16 – 14 AWG	Blue	.162	.75	.15				.08	.110 x .032
DNF14-111-C*					.162	.75	.15	.07	.110 x .020			
DNF14-187-C					.162	.76	.23	.10	.187 x .032	CT-600-A‡, CT-1550, CT-1551, CT-2500	100	500
DNF14-188-C	.162	.76			.23	.10	.187 x .020					
DNF14-205-C	.162	.76			.25	.12	.205/.187 x .032					
DNF14-206-C	.162	.76			.25	.12	.205/.187 x .020					
DNF14-250-C	.162	.83			.29	.12	.250 x .032					

*Not UL Listed or CSA Certified.

**To order in bulk, replace -C in the part number with -M for a bulk package of 1000.

‡UL and CSA approved tooling/product combinations. For crimping tool information, see pages D1.84, D1.86, and D1.88.

A. System Overview

B1. Cable Ties



Female Disconnect, Vinyl Barrel Insulated – Funnel Entry

Type DVF

- Disconnect can be inserted and removed from the male tab without the use of tools for lower installed cost
- Metal insulation grip sleeve crimps to wire insulation, providing protection to the crimp joint during high vibration applications
- Internal barrel serrations assure good wire contact and maximum tensile strength
- Internal wire stop assures proper length of insertion into terminal barrel, providing a higher quality connection
- UL Flammability UL 94V-0, maximum insulation temperature 194°F (90°C)

B2. Cable Accessories

B3. Stainless Steel Ties



C1. Wiring Duct



C2. Surface Raceway

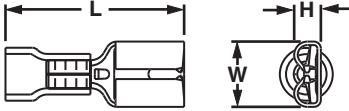

C3. Abrasion Protection

Part Number	Wire Range	Color Code	Max. Ins.	Figure Dimensions (In.)			Tab Size	Recommended Installation Tool	Std. Pkg. Qty.**	Std. Ctn. Qty.
				L	W	H				
DVF18-187-CY	22 – 18 AWG	Red	.137	.76	.23	.10	.187 x .032	CT-1550‡, CT-1551‡, CT-2500‡	100	500
DVF18-188-CY			.137	.76	.23	.10	.187 x .020		100	500
DVF18-205-CY			.137	.76	.25	.12	.205/.187 x .032		100	500
DVF18-206-CY			.137	.76	.25	.12	.205/.187 x .020		100	500
DVF18-250-CY			.137	.81	.29	.12	.250 x .032		100	500
DVF14-187-C	16 – 14 AWG	Blue	.162	.76	.23	.10	.187 x .032	CT-1550‡, CT-1551‡, CT-2500‡	100	500
DVF14-188-C			.162	.76	.23	.10	.187 x .020		100	500
DVF14-205-C			.162	.76	.25	.12	.205/.187 x .032		100	500
DVF14-206-C			.162	.76	.25	.12	.205/.187 x .020		100	500
DVF14-250-C			.162	.81	.29	.12	.250 x .032		100	500

**To order in bulk, replace -C or -CY in the part number with -M or -MY for a bulk package of 1000.

‡UL and CSA approved tooling/product combinations. For crimping tool information, see pages D1.84 and D1.88.

C4. Cable Management

D1. Terminals



Female Disconnect, Vinyl Barrel Insulated – Butted Seam

Type DV-B

- Disconnect can be inserted and removed from the male tab without the use of tools for lower installed cost
- Metal insulation grip sleeve crimps to wire insulation, providing protection to the crimp joint during high vibration applications
- Internal barrel serrations assure good wire contact and maximum tensile strength
- Internal wire stop assures proper length of insertion into terminal barrel, providing a higher quality connection
- UL Flammability UL 94V-0, maximum insulation temperature 221°F (105°C)

D2. Power Connectors

D3. Grounding Connectors



E2. Labels



E3. Pre-Printed & Write-On Markers



E4. Permanent Identification

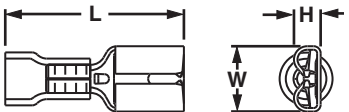

Part Number	Wire Range	Color Code	Max. Ins.	Figure Dimensions (In.)			Tab Size	Recommended Installation Tool	Std. Pkg. Qty.**	Std. Ctn. Qty.
				L	W	H				
DV18-187B-CY	22 – 18 AWG	Red	.150	.75	.23	.10	.187 x .032	CT-1525‡, CT-2500‡	100	500
DV18-188B-CY			.150	.76	.23	.10	.187 x .020		100	500
DV18-205B-CY			.150	.75	.25	.12	.187/.205 x .032		100	500
DV18-206B-CY			.150	.75	.25	.12	.187/.205 x .020		100	500
DV18-250B-CY			.150	.81	.29	.12	.250 x .032		100	500
DV14-187B-C	16 – 14 AWG	Blue	.170	.75	.23	.10	.187 x .032	CT-1525^, CT-2500	100	500
DV14-188B-C			.162	.79	.23	.10	.187 x .020		100	500
DV14-205B-C			.170	.75	.25	.12	.187/.205 x .032		100	500
DV14-206B-C			.170	.75	.25	.12	.187/.205 x .020		100	500
DV14-250B-C			.170	.81	.29	.12	.250 x .032		100	500
DV10-250-L*	12 – 10 AWG	Yellow	.229	1.03	.30	.13	.250 x .032	CT-1550^, CT-1551^, CT-2500	50	500

*Sleeved barrel, maximum insulation temperature 194°F (90°C).

**To order in bulk, replace -C or -CY in the part number with -M or -MY for a bulk package of 1000 and replace -L with -D for a bulk package of 500.

‡UL and CSA approved tooling/product combinations. For crimping tool information, see page D1.84 and D1.88.

^CSA approved tooling/product combinations.

*UL Recognized only.

E5. Lockout/Tagout & Safety Solutions

F. Index



Female Disconnect, Non-Insulated – Metal Sleeve

Type D

- Disconnect can be inserted and removed from the male tab without the use of tools for lower installed cost
- Sleeved barrel helps to facilitate high mechanical and electrical performance when crimping
- Barrel of terminal internally beveled to provide quick and easy wire insertion
- Internal barrel serrations assure good wire contact and maximum tensile strength
- Internal wire stop assures proper length of insertion into terminal barrel, providing a higher quality connection
- Maximum recommended operating temperature 302°F (150°C)

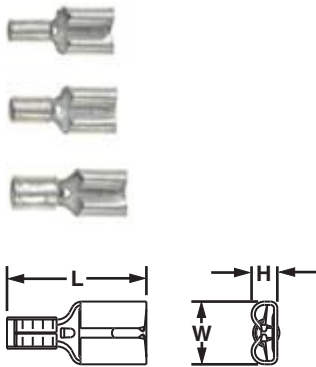

Part Number	Wire Range	Figure Dimensions (In.)			Tab Size	Recommended Installation Tool	Std. Pkg. Qty.**	Std. Ctn. Qty.
		L	W	H				
D18-187-C	22 – 18 AWG	.58	.23	.10	.187 x .032	CT-100‡, CT-200‡, CT-1570‡, CT-2500‡	100	500
D18-188-C		.58	.23	.10	.187 x .020		100	500
D18-250-C		.66	.30	.12	.250 x .032		100	500
▲ D14-187-C	16 – 14 AWG	.58	.23	.10	.187 x .032	CT-100, CT-200, CT-600-A, CT-1570, CT-2500	100	500
▲ D14-188-C		.58	.23	.10	.187 x .020		100	500
▲ D14-250-C		.66	.30	.12	.250 x .032		100	500
D10-250-L	12 – 10 AWG	.72	.30	.12	.250 x .032	CT-600-A‡, CT-1570‡, CT-1701‡, CT-2500‡	50	500

**To order in bulk, replace -C in the part number with -M for a bulk package of 1000 and replace -L with -D for a bulk package of 500.

‡UL and CSA approved tooling/product combinations. For crimping tool information, see pages D1.83, D1.84, D1.86 and D1.88.

*UL Recognized only.



Right Angle Female Disconnect, Nylon Fully Insulated – Funnel Entry

Type DNFR-FIB

- Right angle design for use in limited space applications
- Fully insulated design provides protection from electrical shorts
- Internal wire stop assures proper length of insertion into terminal barrel, providing a higher quality connection
- Disconnect can be inserted and removed from the male tab without the use of tools for lower installed cost
- Disconnects available in common industry tab sizes

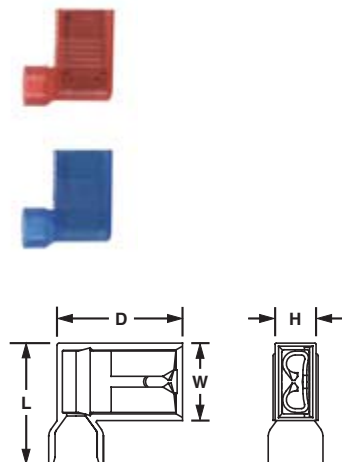

Part Number	Wire Range	Color Code	Max. Ins.	Figure Dimensions (In.)				Tab Size	Recommended Installation Tool	Std. Pkg. Qty.**	Std. Ctn. Qty.
				L	W	H	D				
DNFR18-205FIB-C	22 – 18 AWG	Red	.178	.58	.37	.21	.60	.205/.187 x .032	CT-300-1	100	1000
DNFR18-206FIB-C			.178	.58	.37	.21	.60	.205/.187 x .020		100	1000
DNFR18-250FIB-C			.178	.58	.37	.21	.60	.250 x .032		100	1000
DNFR14-205FIB-C	16 – 14 AWG	Blue	.178	.58	.37	.21	.60	.205/.187 x .032	CT-300-1	100	1000
DNFR14-206FIB-C			.178	.58	.37	.21	.60	.205/.187 x .020		100	1000
DNFR14-250FIB-C			.178	.58	.37	.21	.60	.250 x .032		100	1000

**To order in bulk, replace -C in the part number with -M for a bulk package of 1000. For crimping tool information, see page D1.85.

A. System Overview

B1. Cable Ties

B2. Cable Accessories

B3. Stainless Steel Ties

C1. Wiring Duct

C2. Surface Raceway

C3. Abrasion Protection

C4. Cable Management

D1. Terminals

D2. Power Connectors

D3. Grounding Connectors

E1. Labeling Systems

E2. Labels

E3. Pre-Printed & Write-On Markers

E4. Permanent Identification

E5. Lockout/Tagout & Safety Solutions

F. Index

A. System Overview

B1. Cable Ties

B2. Cable Accessories

B3. Stainless Steel Ties

C1. Wiring Duct

C2. Surface Raceway

C3. Abrasion Protection

C4. Cable Management

D1. Terminals

D2. Power Connectors

D3. Grounding Connectors

E1. Labeling Systems

E2. Labels

E3. Pre-Printed & Write-On Markers

E4. Permanent Identification

E5. Lockout/Tagout & Safety Solutions

F. Index



Right Angle Female Disconnect, Nylon Insulated – Funnel Entry

Type DNFR-B

- Right angle design for use in limited space applications
- Disconnect can be inserted and removed from the male tab without the use of tools for lower installed cost
- Disconnects available in common industry tab sizes
- Longer barrel design for use with PANDUIT standard disconnect tool

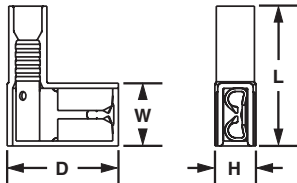

Part Number	Wire Range	Color Code	Max. Ins.	Figure Dimensions (In.)				Tab Size	Recommended Installation Tool	Std. Pkg. Qty.	Std. Ctn. Qty.
				L	W	H	D				
DNFR18-205B-C	22 – 18 AWG	Red	.130	.78	.36	.20	.62	.205/.187 x .032	CT-1525‡, CT-2500‡	100	1000
DNFR18-206B-C			.130	.78	.36	.20	.62	.205/.187 x .020			
DNFR18-250B-C			.130	.78	.36	.20	.62	.250 x .032			
DNFR14-205B-C	16 – 14 AWG	Blue	.155	.78	.36	.20	.63	.205/.187 x .032	CT-1525‡, CT-2500‡	100	1000
DNFR14-206B-C			.155	.78	.36	.20	.63	.205/.187 x .020			
DNFR14-250B-C			.155	.78	.36	.20	.63	.250 x .032			

**To order in bulk, replace -C in the part number with -M for a bulk package of 1000 and replace -L with -D for a bulk package of 500.

‡UL and CSA approved tooling/product combinations. For crimping tool information, see pages D1.84 and D1.88.



Right Angle Female Disconnect, Non-Insulated – Metal Sleeve

Type DR

- Right angle design for use in limited space applications
- Disconnect can be inserted and removed from the male tab without the use of tools for lower installed cost
- Sleeved barrel helps to facilitate high mechanical and electrical performance when crimping
- Barrel of terminal internally beveled to provide quick and easy wire insertion
- Internal barrel serrations assure good wire contact and maximum tensile strength
- Maximum recommended operating temperature 302°F (150°C)

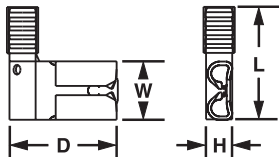

Part Number	Wire Range	Figure Dimensions (In.)				Tab Size	Recommended Installation Tool	Std. Pkg. Qty.	Std. Ctn. Qty.
		L	W	H	D				
DR18-205-C	22 – 18 AWG	.54	.25	.12	.53	.205/.187 x .032	CT-100‡, CT-200‡, CT-600-A‡, CT-1570‡, CT-2500‡	100	1000
DR18-206-C		.54	.25	.12	.53	.205/.187 x .020			
DR18-250-C		.57	.30	.12	.54	.250 x .032			
DR14-205-C	16 – 14 AWG	.54	.25	.12	.55	.205/.187 x .032	CT-100‡, CT-200‡, CT-600-A‡, CT-1570‡, CT-2500‡	100	1000
DR14-206-C		.54	.25	.12	.55	.205/.187 x .020			
DR14-250-C		.57	.30	.12	.55	.250 x .032			
DR10-250-L	12 – 10 AWG	.61	.30	.12	.57	.250 x .032	CT-100‡, CT-200‡, CT-600-A‡, CT-1570‡, CT-1701‡, CT-2500‡	50	500

**To order in bulk, replace -C in the part number with -M for a bulk package of 1000 and replace -L with -D for a bulk package of 500.

‡UL and CSA approved tooling/product combinations. For crimping tool information, see pages D1.83, D1.84, D1.86 and D1.88.

▲UL Recognized only.

SP® Right Angle Female Disconnect, Non-Insulated

Type DR-B

- Barrel of terminal internally beveled to provide quick and easy wire insertion
- Internal barrel serrations assure good wire contact and maximum tensile strength
- Butted seam offers an economical solution for less demanding applications
- For use in limited space applications

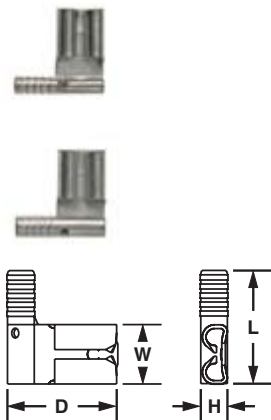

Part Number	Wire Range	Figure Dimensions (In.)				Tab Size	Recommended Installation Tool	Std. Pkg. Qty.**	Std. Ctn. Qty.
		L	W	H	D				
DR18-205B-C	22 – 18 AWG	.54	.25	.12	.53	.205/.187 x .032	CT-100, CT-200	100	1000
DR18-206B-C		.54	.25	.12	.53	.205/.187 x .020		100	1000
DR18-250B-C		.55	.30	.12	.53	.250 x .032		100	1000
DR14-205B-C*	16 – 14 AWG	.54	.25	.12	.55	.205/.187 x .032	CT-100, CT-200	100	1000
DR14-206B-C*		.54	.25	.12	.55	.205/.187 x .020		100	1000
DR14-250B-C		.55	.30	.12	.55	.250 x .032		100	1000

*Not CSA Certified.

**To order in bulk, replace -C in the part number with -M for a bulk package of 1000. For crimping tool information, see page D1.83.

Piggyback Disconnect, Vinyl Insulated

Type DV-P

- Combination of female disconnect and male tab allows versatility in points of connection
- Multiple connection points allow additional circuits to be added to existing equipment without expensive rework
- Metal insulation grip sleeve crimps to wire insulation, providing protection to the crimp joint during high vibration applications

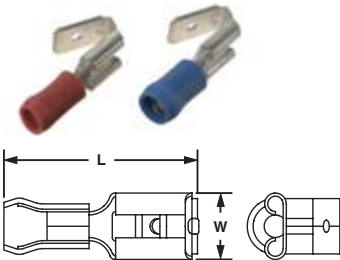

Part Number	Wire Range	Color Code	Max. Ins.	Figure Dimensions (In.)		Tab Size	Recommended Installation Tool	Std. Pkg. Qty.**	Std. Ctn. Qty.
				L	W				
DV18-250P-CY	22 – 18 AWG	Red	.130	.88	.29	.250 x .032	CT-100, CT-260, CT-1550, CT-1551, CT-2500	100	1000
DV14-250P-C	16 – 14 AWG	Blue	.160	.88	.29	.250 x .032		100	1000

**To order in bulk, replace -C or CY in the part number with -M or MY for a bulk package of 1000. For crimping tool information, see pages D1.83, D1.84, and D1.88.

Disconnect Adapter, Non-Insulated

Type D-A

- Couples two female disconnects to one male disconnect (all .250 x .032)
- Multiple connection points allow additional circuits to be added to existing equipment without expensive rework
- Disconnect can be inserted and removed from the male tab without the use of tools for lower installed cost

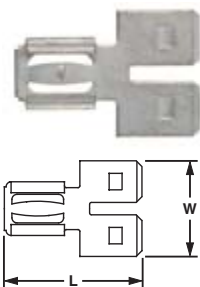

Part Number	Figure Dimensions (In.)		Tab Size	Std. Pkg. Qty.**	Std. Ctn. Qty.
	L	W			
D-250A-C	.82	.57	.250 x .032	100	1000

**To order in bulk, replace -C in the part number with -M for a bulk package of 1000.

A. System Overview

B1. Cable Ties

B2. Cable Accessories

B3. Stainless Steel Ties

C1. Wiring Duct

C2. Surface Raceway

C3. Abrasion Protection

C4. Cable Management

D1. Terminals

D2. Power Connectors

D3. Grounding Connectors

E1. Labeling Systems

E2. Labels

E3. Pre-Printed & Write-On Markers

E4. Permanent Identification

E5. Lockout/Tagout & Safety Solutions

F. Index

A. System Overview

B1. Cable Ties

SP CERTIFIED Male Disconnect, Nylon Barrel Insulated – Funnel Entry

Type DNF-M

- Male tab couples with (all .250 x .032) female disconnects
- Male tab can be inserted and removed from the female disconnect without the use of tools for lower installed cost
- Metal insulation grip sleeve crimps to wire insulation, providing protection to the crimp joint during high vibration applications
- Internal barrel serrations assure good wire contact and maximum tensile strength
- Maximum insulation temperature 221°F (105°C)

B3. Stainless Steel Ties



C1. Wiring Duct



C2. Surface Raceway

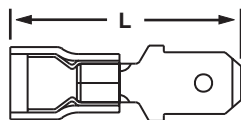

C3. Abrasion Protection

C4. Cable Management

Part Number	Wire Range	Color Code	Max. Ins.	Figure Dimensions (In.)		Recommended Installation Tool	Std. Pkg. Qty.**	Std. Ctn. Qty.
				L	Tab Size			
DNF18-250M-C	22 – 18 AWG	Red	.136	.90	.250 x .032	CT-1550, CT-1551, CT-2500	100	1000
DNF14-250M-C	16 – 14 AWG	Blue	.162	.90	.250 x .032		100	1000
DNF10-250M-L*	12 – 10 AWG	Yellow	.230	1.03	.250 x .032		50	500

*Not UL Listed or CSA Certified.

**To order in bulk, replace -C in the part number with -M for a bulk package of 1000 and replace -L with -D for a bulk package of 500.

For crimping tool information, see pages D1.84 and D1.88.

D1. Terminals

D2. Power Connectors

D3. Grounding Connectors

SP CERTIFIED Male Disconnect, Vinyl Barrel Insulated – Funnel Entry

Type DV-MB

- Male tab couples with (all .250 x .032) female disconnects
- Insulation support helps to prevent wire damage in bending applications
- Male tab can be inserted and removed from the female disconnect without the use of tools for lower installed cost
- UL and CSA rated up to 600 V per UL 310

E1. Labeling Systems



E2. Labels



E3. Pre-Printed & Write-On Markers



E4. Permanent Identification

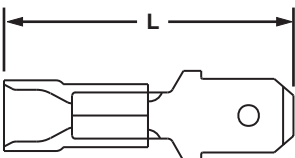

E5. Lockout/Tagout & Safety Solutions

F. Index

Part Number	Wire Range	Color Code	Max. Ins.	Figure Dimensions (In.)		Recommended Installation Tool	Std. Pkg. Qty.**	Std. Ctn. Qty.
				L	Tab Size			
DV18-250MB-CY	22 – 18 AWG	Red	.154	.98	.250 x .032	CT-1550, CT-1551, CT-2500	100	500
DV14-250MB-C	16 – 14 AWG	Blue	.180	.96	.250 x .032		100	500
DV10-250M-L*	12 – 10 AWG	Yellow	.235	.98	.250 x .032		50	500

*Not UL Listed or CSA Certified.

**To order in bulk, replace -C or -CY in the part number with -M or -MY for a bulk package of 1000 and replace -L with -D for a bulk package of 500.

For crimping tool information, see pages D1.84 and D1.88.

Male Disconnect, Non-Insulated – Butted Seam

Type D-MB

- Male tab couples with (all .250 x .032) female disconnects
- Male tab can be inserted and removed from the female disconnect without the use of tools for lower installed cost
- Internal barrel serrations assure good wire contact and maximum tensile strength
- Barrel of terminal internally beveled to provide quick and easy wire insertion
- Maximum recommended operating temperature 302°F (150°C)

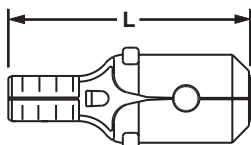

Part Number	Wire Range	Figure Dimensions (In.)		Tab Size	Recommended Installation Tool	Std. Pkg. Qty.**	Std. Ctn. Qty.
		L					
D18-250MB-C	22 – 18 AWG	.69		.250 x .032	CT-100	100	500
D14-250MB-C	16 – 14 AWG	.69		.250 x .032		100	500
D10-250M-L*	12 – 10 AWG	.72		.250 x .032	CT-100, CT-200, CT-260, CT-1570, CT-2500	50	500

*Brazed seam.

**To order in bulk, replace -C in the part number with -M for a bulk package of 1000 and replace -L with -D for a bulk package of 500.

For crimping tool information, see pages D1.83, D1.84, and D1.88.

A.
System
Overview

B1.
Cable
Ties

B2.
Cable
Accessories

B3.
Stainless
Steel Ties

C1.
Wiring
Duct

C2.
Surface
Raceway

C3.
Abrasion
Protection

C4.
Cable
Management

D1.
Terminals

D2.
Power
Connectors

D3.
Grounding
Connectors

E1.
Labeling
Systems

E2.
Labels

E3.
Pre-Printed
& Write-On
Markers

E4.
Permanent
Identification

E5.
Lockout/
Tagout/
& Safety
Solutions

F.
Index

A. System Overview

Selection Guide – Specialty Terminals

B1. Cable Ties

B2. Cable Accessories

B3. Stainless Steel Ties

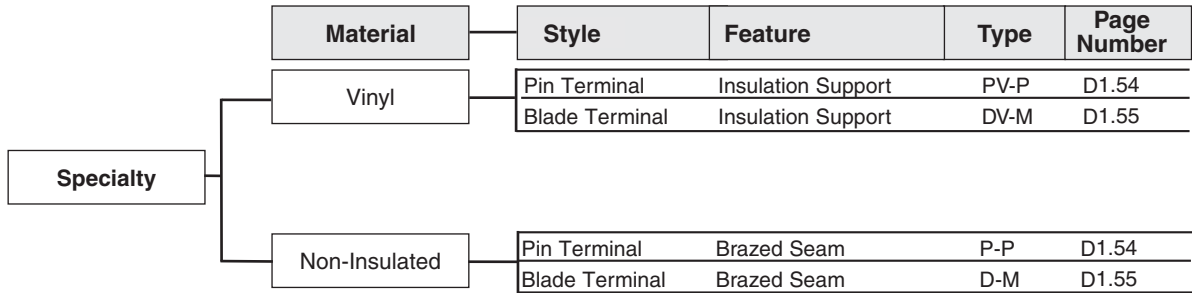

C1. Wiring Duct

Pin Terminal, Vinyl Insulated – Funnel Entry Type PV-P

C2. Surface Raceway

- Solid pin designed to prevent damage to the wire from over tightening, resulting in a reliable electrical connection
- Insulation support helps to prevent wire damage in bending applications
- Brazen seam protects terminal barrel from splitting during the crimp process

- Internal barrel serrations assure good wire contact and maximum tensile strength
- UL rated up to 600 V per UL 486 (18 and 14 gauge only)
- For use with pin-type terminal blocks

C3. Abrasion Protection



C4. Cable Management



D1. Terminals



Part Number	Wire Range	Color Code	Max. Ins.	Figure Dimensions (In.)			Recommended Installation Tool	Std. Pkg. Qty.**	Std. Ctn. Qty.
				L	W	P			
PV18-P47-CY	22 – 18 AWG	Red	.150	.97	.07	.49	CT-100, CT-260, CT-1550, CT-1551, CT-2500	100	1000
PV14-P47-C	16 – 14 AWG	Blue	.170	.97	.07	.49		100	1000
PV10-P55-L*	12 – 10 AWG	Yellow	.250	1.10	.10	.55		50	500

*Not UL Recognized.

**To order in bulk, replace -C or -CY in the part number with -M or -MY for a bulk package of 1000 and replace -L with -D for a bulk package of 500.

For crimping tool information, see pages D1.83, D1.84, and D1.88.

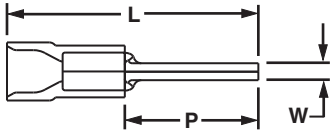

D2. Power Connectors

D3. Grounding Connectors

Pin Terminal, Non-Insulated Type P-P

E1. Labeling Systems

- Solid pin designed to prevent damage to the wire from over tightening, resulting in a reliable electrical connection
- Brazen seam protects terminal barrel from splitting during the crimp process
- Internal barrel serrations assure good wire contact and maximum tensile strength

- Barrel of terminal internally beveled to provide quick and easy wire insertion
- UL rated up to 600 V per UL 486 (18 and 14 gauge only)
- Maximum recommended operating temperature 302°F (150°C)
- For use with pin-type terminal blocks

E2. Labels

E3. Pre-Printed & Write-On Markers



E4. Permanent Identification



E5. Lockout/Tagout & Safety Solutions



Part Number	Wire Range	Figure Dimensions (In.)			Recommended Installation Tool	Std. Pkg. Qty.**	Std. Ctn. Qty.
		L	W	P			
P18-P47-C	22 – 18 AWG	.75	.07	.49	CT-100, CT-200, CT-260, CT-1570, CT-2500	100	1000
P14-P47-C	16 – 14 AWG	.75	.07	.49		100	1000
P10-P55-L*	12 – 10 AWG	.79	.11	.55	CT-100, CT-200, CT-260, CT-1570, CT-2500	50	500

*Not UL Recognized.

**To order in bulk, replace -C in the part number with -M for a bulk package of 1000 and replace -L with -D for a bulk package of 500.

‡UL and CSA approved tooling/product combinations. For crimping tool information, see pages D1.83, D1.84, and D1.88.

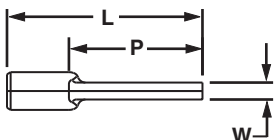

PA **SP** Male Blade Adapter, Vinyl Insulated – Funnel Entry

Type DV-M

- Flat blade design to prevent damage to the wire from over tightening, resulting in a reliable electrical connection
- For use with blade-type terminal blocks
- Insulation support helps to prevent wire damage in bending applications
- Brazed seam protects terminal barrel from splitting during the crimp process

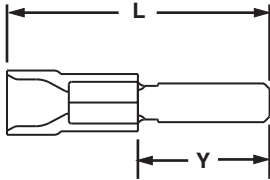

Part Number	Wire Range	Color Code	Max. Ins.	Figure Dimensions (In.)		Tab Size	Recommended Installation Tool	Std. Pkg. Qty.**	Std. Ctn. Qty.
				L	Y				
DV18-145M-CY	22 – 18 AWG	Red	.150	.97	.42	.145 x .032	CT-600-A, CT-1550‡, CT-1551‡, CT-2500‡	100	500
DV14-145M-C	16 – 14 AWG	Blue	.170	.97	.42	.145 x .032		100	500

**To order in bulk, replace -C or -CY in the part number with -M or -MY for a bulk package of 1000.
‡UL and CSA approved tooling/product combinations. For crimping tool information, see pages D1.84, D1.86, and D1.88.

PA **SP** Male Blade Adapter, Non-Insulated

Type D-M

- Flat blade design to prevent damage to the wire from over tightening, resulting in a reliable electrical connection
- For use with blade-type terminal blocks
- Internal barrel serrations assure good wire contact and maximum tensile strength
- Brazed seam protects terminal barrel from splitting during the crimp process
- Barrel of terminal internally beveled to provide quick and easy wire insertion

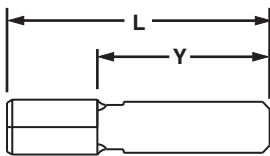

Part Number	Wire Range	Figure Dimensions (In.)		Tab Size	Recommended Installation Tool	Std. Pkg. Qty.**	Std. Ctn. Qty.
		L	Y				
D18-145M-C	22 – 18 AWG	.75	.42	.145 x .032	CT-100‡, CT-200‡, CT-600-A, CT-1570‡, CT-2500‡	100	500
D14-145M-C	16 – 14 AWG	.75	.42	.145 x .032		100	500

**To order in bulk, replace -C in the part number with -M for a bulk package of 1000.
‡UL and CSA approved tooling/product combinations. For crimping tool information, see pages D1.83, D1.84, D1.86 and D1.88.

A.
System Overview

B1.
Cable Ties

B2.
Cable Accessories

B3.
Stainless Steel Ties

C1.
Wiring Duct

C2.
Surface Raceway

C3.
Abrasion Protection

C4.
Cable Management

D1.
Terminals

D2.
Power Connectors

D3.
Grounding Connectors

E1.
Labeling Systems

E2.
Labels

E3.
Pre-Printed & Write-On Markers

E4.
Permanent Identification

E5.
Lockout/ Tagout & Safety Solutions

F.
Index

A. System Overview

Features and Benefits – PAN-TERM® Metric Disconnects

B1. Cable Ties

Metric Nylon Fully Insulated Female and Male Tabs Type DMNF-FIB

Available in tab sizes to accommodate 2.8, 4.8, and 6.3mm tabs

Fully insulated design provides protection from electrical shorts

Expanded wire entry (on select sizes) accommodates large insulation or multiple wires

Maximum insulation temperature 257°F (125°C)

Insulation support restricts excessive wire movement to minimize stress on crimp joint

Funnel entry for faster wire insertion and lower installed cost

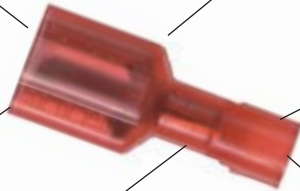

Rated at 600 V.

B2. Cable Accessories

B3. Stainless Steel Ties

C1. Wiring Duct

C2. Surface Raceway

C3. Abrasion Protection

C4. Cable Management

D1. Terminals

D2. Power Connectors

D3. Grounding Connectors

E1. Labeling Systems

E2. Labels

E3. Pre-Printed & Write-On Markers

E4. Permanent Identification

E5. Lockout/Tagout & Safety Solutions

F. Index

Nylon Barrel Insulated Female Receptacles and Male Tabs Type DMNF

Available in tab sizes to accommodate 2.8, 4.8, and 6.3mm tabs

Maximum insulation temperature 194°F (90°C)

Funnel entry for faster wire insertion and lower installed cost



Rated at 600 V.

Vinyl Barrel Insulated Female Receptacles Type DMV

Available in tab sizes to accommodate 2.8, 4.8, and 6.3mm tabs

Maximum insulation temperature 221°F (105°C)

Insulation support to protect electrical crimp

Insulation grip sleeve provides a superior insulation crimp for high vibration and high strain relief applications



Rated at 600 V.
Flammability UL 94V-0.

Non-Insulated Female Receptacles and Male Tabs Type DM

Available in tab sizes to accommodate 2.8, 4.8, and 6.3mm tabs

Maximum recommended operating temperature 302°F (150°C)

Sleeved barrel assures crimp reliability

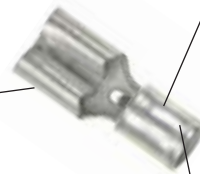

PANDUIT extensive line of tooling is specifically designed for optimum crimping performance.

See pages D1.83 – D1.88.



PANDUIT designs and manufactures a full line of labeling products, software, and printers to assist you with your labeling requirements.

See pages E1.1 – E2.30.

Part Number System for PAN-TERM® Metric Disconnects

DM	NF	1	—	285	—	FIB	—	C
Type	Insulation	Wire Range		Size and Type		Special Configuration		Package Size
DM = Disconnect Metric	N = Nylon NF = Nylon Funnel V = Vinyl	1 = .5 – 1.0mm ² (22 – 18 AWG) 2 = 1.5 – 2.5mm ² (16 – 14 AWG) 6 = 4.0 – 6.0mm ² (12 – 10 AWG)		285 = 2.8mm x .5mm (.110 x .020) 288 = 2.8mm x .8mm (.110 x .032) 488 = 4.8mm x .8mm (.188 x .032) 63 = 6.3mm x .8mm (.250 x .032)		B = Butted Seam FI = Fully Insulated Female FIB = Fully Insulated Butted Seam Female FIM = Fully Insulated Male M = Male MB = Butted Seam Male		X = 10 E = 20 Q = 25 L = 50 C = 100

Female Metric Disconnect, Fully Insulated Nylon – Funnel Entry

Type DMNF-FIB

- Disconnect can be inserted and removed from the male tab without the use of tools for lower installed cost
- Fully insulated design provides protection from electrical shorts
- Disconnects available in common industry tab sizes
- Internal wire stop assures proper length of insertion into terminal barrel, providing a higher quality connection

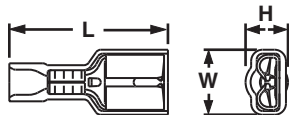

Part Number	Wire Range	Color Code	Max. Ins.	Figure Dimensions (mm)			Tab Size	Recommended Installation Tool	Std. Pkg. Qty.	Std. Ctn. Qty.
				L	W	H				
DMNF1-285FIB-C	.5 – 1.0	Red	3.05	18.0	4.8	4.1	2.8 x .5	CT-1525, CT-2500	100	500
DMNF1-288FIB-C			3.05	18.0	4.8	4.1	2.8 x .8		100	500
DMNF1-488FIB-C**	.5 – 1.0		3.35	19.8	7.9	5.5	4.8 x .8		100	1000
DMNF1-63FIB-C			3.35	21.3	8.9	5.5	6.3 x .8		100	500
DMNF2-488FIB-C**	1.5 – 2.5	Blue	3.96	19.8	7.9	5.5	4.8 x .8	CT-1551	100	1000
DMNF2-63FIB-C			3.96	21.3	8.9	5.5	6.3 x .8		100	500
DMNF6-63FI-L	4.0 – 6.0	Yellow	5.84	24.4	8.9	6.9	6.3 x .8	CT-1551	50	250

**Only DMNF1-488FIB and DMNF2-488FIB are available in bulk; to order, replace -C in the part number with -M for a bulk package of 1000.

For crimping tool information, see pages D1.84 and D1.88.

A. System Overview

B1. Cable Ties

B2. Cable Accessories

B3. Stainless Steel Ties

C1. Wiring Duct

C2. Surface Raceway

C3. Abrasion Protection

C4. Cable Management

D1. Terminals

D2. Power Connectors

D3. Grounding Connectors

E1. Labeling Systems

E2. Labels

E3. Pre-Printed & Write-On Markers

E4. Permanent Identification

E5. Lockout/Tagout & Safety Solutions

F. Index

A. System Overview

Female Metric Disconnect, Nylon Barrel Insulated – Funnel Entry

B1. Cable Ties

Type DMNF

- Disconnect can be inserted and removed from the male tab without the use of tools for lower installed cost
- Fully insulated design provides protection from electrical shorts
- Metal insulation grip sleeve crimps to wire insulation, providing protection to the crimp joint during high vibration applications
- Internal barrel serrations assure good wire contact and maximum tensile strength
- Internal wire stop assures proper length of insertion into terminal barrel, providing a higher quality connection

B2. Cable Accessories

B3. Stainless Steel Ties



C1. Wiring Duct



C2. Surface Raceway

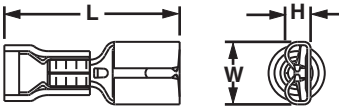

Part Number	Wire Range (mm ²)	Color Code	Max. Ins.	Figure Dimensions (mm)			Tab Size (mm)	Recommended Installation Tool	Std. Pkg. Qty.	Std. Ctn. Qty.
				L	W	H				
DMNF1-285-C	.5 – 1.0	Red	2.50	17.8	3.8	2.0	2.8 x .5	CT-1551	100	500
DMNF1-288-C			2.50	17.6	3.8	2.0	2.8 x .8		100	500
DMNF1-488-C			3.60	19.6	5.8	2.5	4.8 x .8		100	500
DMNF1-63-C	.5 – 1.5	Red	3.58	20.7	7.4	3.1	6.3 x .8		100	500
DMNF2-288-C			4.20	18.8	3.8	2.0	2.8 x .8		100	500
DMNF2-488-C			4.20	19.6	5.8	2.5	4.8 x 0.8		100	500
DMNF2-63-C	1.5 – 2.5	Blue	4.22	21.1	7.4	3.1	6.3 x 0.8		100	500

For crimping tool information, see page D1.84.

C3. Abrasion Protection

Female Metric Disconnect, Vinyl Barrel Insulated – Funnel Entry

C4. Cable Management

Type DMV

- Disconnect can be inserted and removed from the male tab without the use of tools for lower installed cost
- Metal insulation grip sleeve crimps to wire insulation, providing protection to the crimp joint during high vibration applications
- Internal barrel serrations assure good wire contact and maximum tensile strength
- Internal wire stop assures proper length of insertion into terminal barrel, providing a higher quality connection

D1. Terminals

D2. Power Connectors



D3. Grounding Connectors

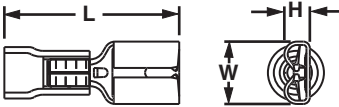

Part Number	Wire Range (mm ²)	Color Code	Max. Ins.	Figure Dimensions (mm)			Tab Size (mm)	Recommended Installation Tool	Std. Pkg. Qty.	Std. Ctn. Qty.
				L	W	H				
DMV6-63-L	4.0 – 6.0	Yellow	5.80	25.7	7.6	3.3	6.3 x .8	CT-1551	50	250

For crimping tool information, see page D1.84.

E1. Labeling Systems

Female Metric Disconnect, Non-Insulated – Metal Sleeve

E2. Labels

Type DM

- Disconnect can be inserted and removed from the male tab without the use of tools for lower installed cost
- Sleeved barrel helps to facilitate high mechanical and electrical performance when crimping
- Barrel of terminal internally beveled to provide quick and easy wire insertion
- Internal barrel serrations assure good wire contact and maximum tensile strength
- Internal wire stop assures proper length of insertion into terminal barrel, providing a higher quality connection

E3. Pre-Printed & Write-On Markers



E4. Permanent Identification



E5. Lockout/Tagout & Safety Solutions

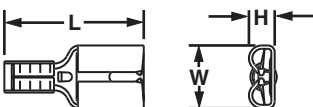

Part Number	Wire Range (mm ²)	Figure Dimensions (mm)			Tab Size (mm)	Recommended Installation Tool	Std. Pkg. Qty.	Std. Ctn. Qty.
		L	W	H				
DM1-488-C	.5 – 1.0	15.0	5.9	2.5	4.8 x .8	CT-1570, CT-2500	100	500
DM1-63-C	.5 – 1.0	16.8	7.6	3.0	6.3 x .8		100	500
DM2-488-C	1.5 – 2.5	15.0	5.9	2.5	4.8 x .8		100	500
DM2-63-C	1.5 – 2.5	16.8	7.6	3.0	6.3 x .8		100	500
DM6-63-L	4.0 – 6.0	18.2	7.6	3.0	6.3 x .8		50	250

For crimping tool information, see pages D1.84 and D1.88.

Piggyback Metric Disconnect, Vinyl Barrel Insulated

Type DMV-P

- Combination of female disconnect and male tab allows versatility in points of connection
- Metal insulation grip sleeve crimps to wire insulation, providing protection to the crimp joint during high vibration applications
- Multiple connection points allow additional circuits to be added to existing equipment without expensive rework

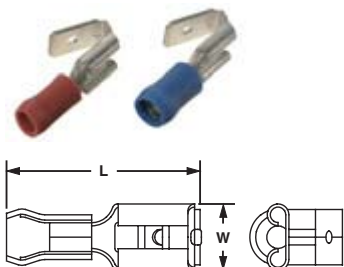

Part Number	Wire Range (mm ²)	Color Code	Max. Ins.	Figure Dimensions (mm)		Tab Size (mm)	Recommended Installation Tool	Std. Pkg. Qty.	Std. Ctn. Qty.
				L	W				
DMV1-63P-CY	.5 – 1.5	Red	3.30	22.4	7.4	6.3 x .8	CT-1551	100	500
DMV2-63P-C	1.5 – 2.5	Blue	4.06	22.4	7.4	6.3 x .8		100	500

For crimping tool information, see page D1.84.

Male Metric Disconnect, Fully Insulated Nylon – Funnel Entry

Type DMNF-FIM

- Male tab couples with (all .250 x .032) female disconnects
- Fully insulated design provides protection from electrical shorts
- Male tab can be inserted and removed from the female disconnect without the use of tools for lower installed cost
- Internal barrel serrations assure good wire contact and maximum tensile strength

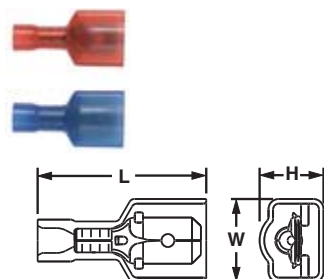

Part Number	Wire Range (mm ²)	Color Code	Max. Ins.	Figure Dimensions (mm)			Tab Size (mm)	Recommended Installation Tool	Std. Pkg. Qty.	Std. Ctn. Qty.
				L	W	H				
DMNF1-63FIM-C	.5 – 1.0	Red	3.38	22.9	10.3	7.03	6.3 x .8	CT-1525, CT-2500	100	500
DMNF2-63FIM-C	1.5 – 2.5	Blue	4.01	22.9	10.4	7.05	6.3 x .8		100	500

For crimping tool information, see pages D1.84 and D1.88.

Male Metric Disconnect, Nylon Barrel Insulated – Funnel Entry

Type DMNF-M

- Male tab couples with (all .250 x .032) female disconnects
- Male tab can be inserted and removed from the female disconnect without the use of tools for lower installed cost
- Metal insulation grip sleeve crimps to wire insulation, providing protection to the crimp joint during high vibration applications
- Internal barrel serrations assure good wire contact and maximum tensile strength

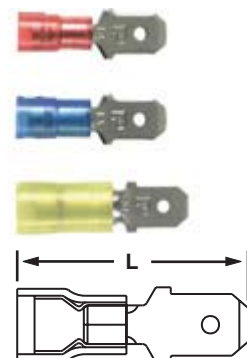

Part Number	Wire Range (mm ²)	Color Code	Max. Ins.	Figure Dimensions (mm)	Tab Size (mm)	Recommended Installation Tool	Std. Pkg. Qty.	Std. Ctn. Qty.
				L				
DMNF1-63M-C	.5 – 1.5	Red	3.96	22.7	6.3 x .8	CT-1551	100	500
DMNF2-63M-C	1.5 – 2.5	Blue	4.83	23.6	6.3 x .8		100	500
DMNF6-63M-L	2.5 – 6.0	Yellow	6.20	23.6	6.3 x .8		50	250

For crimping tool information, see page D1.84.

A.
System
Overview

B1.
Cable Ties

B2.
Cable
Accessories

B3.
Stainless
Steel Ties

C1.
Wiring
Duct

C2.
Surface
Raceway

C3.
Abrasion
Protection

C4.
Cable
Management

D1.
Terminals

D2.
Power
Connectors

D3.
Grounding
Connectors

E1.
Labeling
Systems

E2.
Labels

E3.
Pre-Printed
& Write-On
Markers

E4.
Permanent
Identification

E5.
Lockout/
Tagout
& Safety
Solutions

F.
Index

A. System Overview

Male Metric Disconnect, Non-Insulated – Butted Seam

B1. Cable Ties

Type DM-M

- Male tab couples with (all 250 x .032) female disconnects
- Male tab can be inserted and removed from the female disconnect without the use of tools for lower installed cost
- Internal barrel serrations assure good wire contact and maximum tensile strength
- Barrel of terminal internally beveled to provide quick and easy wire insertion

B2. Cable Accessories



B3. Stainless Steel Ties

C1. Wiring Duct

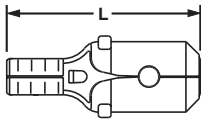

C2. Surface Raceway

C3. Abrasion Protection

Metric Pin Terminal, Vinyl Insulated – Funnel Entry

Type PMV-P

- Solid pin designed to prevent damage to the wire from over tightening, resulting in a reliable electrical connection
- For use with pin-type terminal blocks
- Insulation support helps to prevent wire damage in bending applications
- Brazed seam protects terminal barrel from splitting during the crimp process
- Internal barrel serrations assure good wire contact and maximum tensile strength

C4. Cable Management

D1. Terminals



D2. Power Connectors

D3. Grounding Connectors

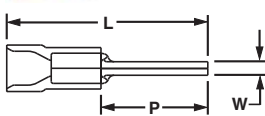

Part Number	Wire Range (mm ²)	Figure Dimensions (mm)		Tab Size (mm)	Recommended Installation Tool	Std. Pkg. Qty.	Std. Ctn. Qty.
		L	P				
DM1-63M-C	.5 – 1.0	19.2		6.3 x .8	CT-1570, CT-2500	100	500
DM2-63M-C	1.5 – 2.5	19.2		6.3 x .8		100	500
DM6-63M-L*	2.5 – 6.0	18.2		6.3 x .8		50	250

*Brazed seam.
For crimping tool information, see pages D1.84 and D1.88.

E1. Labeling Systems

Metric Pin Terminal, Non-Insulated

Type PM-P

- Solid pin designed to prevent damage to the wire from over tightening, resulting in a reliable electrical connection
- For use with pin-type terminal blocks
- Insulation support helps to prevent wire damage in bending applications
- Brazed seam protects terminal barrel from splitting during the crimp process
- Internal barrel serrations assure good wire contact and maximum tensile strength

E2. Labels

E3. Pre-Printed & Write-On Markers



E4. Permanent Identification

E5. Lockout/Tagout & Safety Solutions

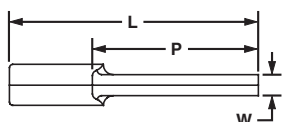

Part Number	Wire Range (mm ²)	Figure Dimensions (mm)			Recommended Installation Tool	Std. Pkg. Qty.	Std. Ctn. Qty.
		L	W	P			
PM1-P10-C	.5 – 1.0	19.0	1.8	12.4	CT-1570, CT-2500	100	500
PM2-P10-C	1.5 – 2.5	19.0	1.8	12.4		100	500
PM6-P10-L	4.0 – 6.0	20.1	2.8	14.0		50	250

For crimping tool information, see pages D1.84 and D1.88.

F. Index

PAN-TERM® SPLICES

PANDUIT® PAN-TERM® Splices are designed and manufactured for fast assembly, and long reliable performance. As the demand for splices increases, it becomes essential to provide a complete system for termination products. We provide an extensive line of tooling designed specifically to provide optimum performance when used as a system for terminating.



- Suitable for in-line, parallel, and group splicing of wires
- Nylon and vinyl insulated as well as non-insulated
- Available in sizes from #26 – 10 AWG
- Internal wire stops on butt splices prevent over insertion of wires
- Applicable sizes are UL Listed and CSA Certified, as noted
- Wide assortment of manual, controlled cycle, battery operated hydraulic and pneumatic crimping tools for reliable connections at the lowest installed cost

PANDUIT continually provides new designs to meet the application challenges encountered by our customers. PANDUIT offers a wide assortment of PAN-TERM® termination products to meet customer needs at the lowest installed cost.

A.
System
Overview

B1.
Cable Ties

B2.
Cable
Accessories

B3.
Stainless
Steel Ties

C1.
Wiring
Duct

C2.
Surface
Raceway

C3.
Abrasion
Protection

C4.
Cable
Management

D1.
Terminals

D2.
Power
Connectors

D3.
Grounding
Connectors

E1.
Labeling
Systems

E2.
Labels

E3.
Pre-Printed
& Write-On
Markers

E4.
Permanent
Identification

E5.
Lockout/
Tagout/
& Safety
Solutions

F.
Index

A. System Overview

Features and Benefits – PAN-TERM® Splices and Wire Joints

B1. Cable Ties

Non-Insulated Wire Joints Type J

Only one crimp needed to complete splice

Maximum recommended operating temperature 302°F (150°C)



Internally beveled barrel for quick easy wire insertion

UL and CSA rated up to 600 V.

Non-Insulated Parallel Splices Type PS

Seamless tubular barrel provides consistent high performance quality crimps

Maximum recommended operating temperature 302°F (150°C)



Only one crimp needed to complete splice

UL and CSA rated up to 300 V.

B2. Cable Accessories

B3. Stainless Steel Ties

C1. Wiring Duct

C2. Surface Raceway

C3. Abrasion Protection

C4. Cable Management

D1. Terminals

D2. Power Connectors

D3. Grounding Connectors

E1. Labeling Systems

E2. Labels

E3. Pre-Printed & Write-On Markers

E4. Permanent Identification

E5. Lockout/Tagout & Safety Solutions

F. Index

Nylon Wire Joints Type JN

Fully insulated housing protects crimp joint

Maximum insulation temperature 221°F (105°C)



Only one crimp needed to complete splice

Deep skirt to accommodate multiple variations of wire combinations

UL and CSA rated up to 600 V. Metric versions available.

Nylon Parallel Splices Type PSN

Maximum insulation temperature 221°F (105°C)



Only one crimp needed to complete splice

UL and CSA rated up to 300 V.



PANDUIT extensive line of tooling is specifically designed for optimum crimping performance.

See pages D1.83 – D1.88.



PANDUIT designs and manufactures a full line of labeling products, software, and printers to assist you with your labeling requirements.

See pages E1.1 – E2.30.

Features and Benefits – PAN-TERM® Splices

Nylon Butt Splices Type BSN

Internal wire stops assure proper insertion length



Maximum insulation temperature 221°F (105°C)

Brazed seam assures crimp reliability

UL and CSA rated up to 600 V.

Vinyl Butt Splices Type BSV

Internal wire stops assure proper insertion, length



Maximum insulation temperature 221°F (105°C)

Expanded wire entry accommodates larger insulation

Brazed seam assures crimp reliability

UL and CSA rated up to 600 V.
Flammability – UL 94V-0.
Metric versions available.

Non-Insulated Butt Splices Type BS

Internal wire stops assure proper insertion length



Brazed seam assures crimp reliability

Maximum recommended operating temperature 302°F (150°C)

Internally beveled barrel for quick easy wire insertion

UL and CSA rated up to 600 V.
Metric versions available.

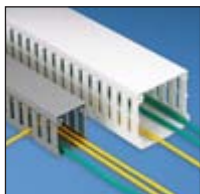

PANDUIT wiring duct offers a wide variety of sizes and types to meet the wire capacity needs and space constraints of the smallest wall mounted to the largest integrated systems.

See pages C1.1 – C1.52.



A comprehensive selection of cable ties used to bundle, mount, and identify wire and cable.

See pages B1.1 – B1.122.

A. System Overview

B1. Cable Ties

B2. Cable Accessories

B3. Stainless Steel Ties

C1. Wiring Duct

C2. Surface Raceway

C3. Abrasion Protection

C4. Cable Management

D1. Terminals

D2. Power Connectors

D3. Grounding Connectors

E1. Labeling Systems

E2. Labels

E3. Pre-Printed & Write-On Markers

E4. Permanent Identification

E5. Lockout/ Tagout & Safety Solutions

F. Index

A. System Overview

Selection Guide – PAN-TERM® Splices and Wire Joints

B1. Cable Ties

B2. Cable Accessories

B3. Stainless Steel Ties

C1. Wiring Duct

C2. Surface Raceway

C3. Abrasion Protection

C4. Cable Management

D1. Terminals

D2. Power Connectors

D3. Grounding Connectors

E1. Labeling Systems

E2. Labels

E3. Pre-Printed & Write-On Markers

E4. Permanent Identification

E5. Lockout/Tagout & Safety Solutions

F. Index



Splices and Wire Joints

Material	Style	Feature	Type	Page Number
Nylon	Butt Splice	Brazed Seam	BSN	D1.65
	Parallel Splice	Seamless Barrel	PSN	D1.66
	Wire Joint	Multiple Wire Connector	JN	D1.67
Vinyl	Butt Splice	Expanded Insulation	BSV	D1.65
Heat Shrink	Butt Splice	Heat Shrink Insulation	BSH	D1.68
Non-Insulated	Butt Splice	Brazed Seam	BS	D1.66
	Parallel Splice	Seamless Barrel	PS	D1.67
	Wire Joint		J	D1.68

Part Number System for PAN-TERM® Splices

BS

Type

BS = Butt Splice
PS = Parallel Splice

V

Insulation

N = Nylon
V = Vinyl

14

Wire Range

22 = #26 – 22
18 = #22 – 18
14 = #16 – 14
13 = #14 – 12
10 = #12 – 10

X

Special Configuration

X = Expanded Insulation

—

M

Standard Package Size

X = 10
Q = 25
L = 50
C = 100
T = 200
D = 500
M = 1000

Part Number System for PAN-TERM® Wire Joints

JN

Type

J = Non-Insulated
JN = Nylon-Insulated

418-212

Wire Range

J Types
214 – 312 = 2 #14 – 3 #12
318 – 412 = 3 #14 – 4 #12
216 – 410 = 2 #16 – 4 #10

JN Types
224 – 318 = 2 #24 – 3 #18
218 – 216 = 2 #18 – 2 #16
418 – 212 = 4 #18 – 2 #12
314 – 412 = 3 #14 – 4 #12

—

C

Standard Package Size

X = 10
Q = 25
L = 50
C = 100
T = 200
D = 500
M = 1000

UL LISTED CERTIFIED **Butt Splice, Nylon Insulated**

Type BSN

- Designed to splice two solid or stranded wires together to repair or lengthen wires
- Butted configuration provides low profile for limited space applications
- Brazed seam protects terminal barrel from splitting during the crimp process
- Internal wire stop assures proper length of insertion into terminal barrel
- UL Flammability UL 94V-2/HB, maximum insulation temperature 221°F (105°C)
- UL and CSA rated up to 600 V per UL 486

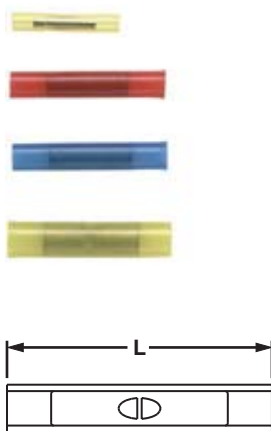

Part Number	Wire Range	Color Code	Max. Ins.	Figure Dimensions (In.)	Recommended Installation Tool	Std. Pkg. Qty.**	Std. Ctn. Qty.
				L			
BSN22-C*	26 – 22 AWG	Yellow	.080	.79	CT-100, CT-1525, CT-2500	100	1000
BSN18-C	22 – 18 AWG	Red	.115	1.15	CT-100, CT-600-A, CT-1550, CT-1551, CT-2500	100	1000
BSN14-C	16 – 14 AWG	Blue	.148	1.15	CT-100, CT-600-A, CT-1550, CT-1551, CT-2500	100	1000
BSN10-L	12 – 10 AWG	Yellow	.210	1.14	CT-100, CT-600-A, CT-1550, CT-1551, CT-2500	50	500

*Not UL Listed.

**To order in bulk, replace -C in the part number with -M for a bulk package of 1000 and replace -L with -D for a bulk package of 500.

For crimping tool information, see pages D1.83, D1.84, D1.86 and D1.88.

UL LISTED CERTIFIED **Butt Splice, Vinyl Insulated**

Type BSV

- Expanded wire entry designed to accommodate wire with a larger insulation thickness
- Designed to splice two solid or stranded wires together to repair or lengthen wires
- Brazed seam protects terminal barrel from splitting during the crimp process
- Internal wire stop assures proper length of insertion into terminal barrel
- UL Flammability UL 94V-0, maximum insulation temperature 221°F (105°C)
- UL and CSA rated up to 600 V per UL 486

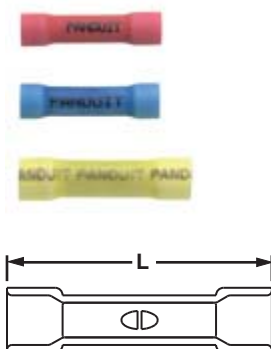

Part Number	Wire Range	Color Code	Max. Ins.	Figure Dimensions (In.)	Recommended Installation Tool	Std. Pkg. Qty.**	Std. Ctn. Qty.
				L			
BSV18X-CY	22 – 18 AWG	Red	.170	1.03	CT-100, CT-600-A, CT-1550, CT-1551, CT-2500	100	1000
BSV14X-C	16 – 14 AWG	Blue	.200	1.04		100	1000
BSV10X-L	12 – 10 AWG	Yellow	.250	1.18		50	500

**To order in bulk, replace -C or -CY in the part number with -M or -MY for a bulk package of 1000 and replace -L with -D for a bulk package of 500.

For crimping tool information, see pages D1.83, D1.84, D1.86 and D1.88.

A. System Overview

B1. Cable Ties

B2. Cable Accessories

B3. Stainless Steel Ties

C1. Wiring Duct

C2. Surface Raceway

C3. Abrasion Protection

C4. Cable Management

D1. Terminals

D2. Power Connectors

D3. Grounding Connectors

E1. Labeling Systems

E2. Labels

E3. Pre-Printed & Write-On Markers

E4. Permanent Identification

E5. Lockout/Tagout & Safety Solutions

F. Index

A. System Overview

B1. Cable Ties



Butt Splice, Non-Insulated

Type BS

- Designed to splice two solid or stranded wires together to repair or lengthen wires
- Butted configuration provides low profile for limited space applications
- Brazed seam protects terminal barrel from splitting during the crimp process
- Internal wire stop assures proper length of insertion into terminal barrel
- Maximum recommended operating temperature 302°F (150°C)
- Non-insulated barrel can be used to provide an economical termination when insulation is not required

B2. Cable Accessories

B3. Stainless Steel Ties



C1. Wiring Duct



C2. Surface Raceway



C3. Abrasion Protection

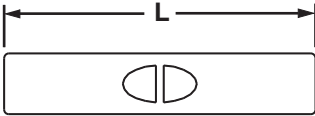

C4. Cable Management

D1. Terminals

D2. Power Connectors

D3. Grounding Connectors

Part Number	Wire Range	Figure Dimensions (In.)	Recommended Installation Tool	Std. Pkg. Qty.**	Std. Ctn. Qty.
		L			
BS22-C*	26 – 22 AWG	.47	CT-100	100	1000
BS18-C	22 – 18 AWG	.62	CT-100, CT-200, CT-600-A, CT-1570, CT-2500	100	1000
BS14-C	16 – 14 AWG	.62	CT-100, CT-200, CT-600-A, CT-1570, CT-2500	100	1000
BS10-L	12 – 10 AWG	.63	CT-100, CT-200, CT-600-A, CT-1570, CT-2500, CT-1701‡	50	500

*Not UL Listed.
 **To order in bulk, replace -C in the part number with -M for a bulk package of 1000 and replace -L with -D for a bulk package of 500.
 ‡UL and CSA approved tooling/product combinations. For crimping tool information, see pages D1.83, D1.84, D1.86 and D1.88.

E1. Labeling Systems

E2. Labels

E3. Pre-Printed & Write-On Markers



E4. Permanent Identification



E5. Lockout/Tagout & Safety Solutions

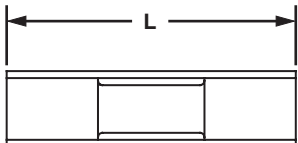

F. Index

Parallel Splice, Nylon Insulated

Type PSN

- Designed to splice two solid or stranded wires together to repair or lengthen wires
- Parallel design results in only one crimp required to complete splice
- Seamless tubular barrel provides a consistent high performance quality crimp
- UL Flammability UL 94V-2/HB, maximum insulation temperature 221°F (105°C)
- UL and CSA rated up to 300 V

Part Number	Wire Range	Color Code	Max. Ins.	Figure Dimensions (In.)	Wire Strip Length (In.)	Recommended Installation Tool	Std. Pkg. Qty.**	Std. Ctn. Qty.
				L				
PSN18-C	22 – 18 AWG	Red	.120	.75	5/16	CT-100, CT-1525, CT-2500	100	500
PSN16-C	20 – 16 AWG	Blue	.150	.75	5/16		100	500
PSN12-L	14 – 12 AWG	Yellow	.210	.83	7/16	CT-100	50	500

**To order in bulk, replace -C in the part number with -M for a bulk package of 1000 and replace -L with -D for a bulk package of 500.
 For crimping tool information, see pages D1.83, D1.84, and D1.88.



Parallel Splice, Non-Insulated

Type PS

- Designed to splice two solid or stranded wires together to repair or lengthen wires
- Parallel design results in only one crimp required to complete splice
- Seamless tubular barrel provides a consistent high performance quality crimp
- Maximum recommended operating temperature 302°F (150°C)
- Non-insulated barrel can be used to provide an economical termination when insulation is not required

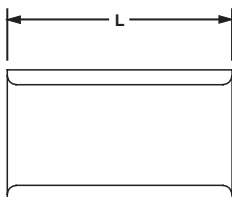

Part Number	Wire Range	Color Code	Max. Ins.	Figure Dimensions (In.)	Wire Strip Length (In.)	Recommended Installation Tool	Std. Pkg. Qty.**	Std. Ctn. Qty.
				L				
PS18-C	22 – 18 AWG	—	—	.29	5/16	CT-100, CT-200	100	500
PS16-C	20 – 16 AWG	—	—	.29	5/16		100	500
PS12-L	14 – 12 AWG	—	—	.38	7/16		50	500

**To order in bulk, replace -C in the part number with -M for a bulk package of 1000 and replace -L with -D for a bulk package of 500.
For crimping tool information, see page D1.83.



Wire Joint, Nylon Insulated

Type JN

- Large barrel, designed to accommodate from one to seven wires with just one crimp
- Accommodates multiple wire sizes in varying combinations
- Barrel of terminal internally beveled to provide quick and easy wire insertion
- UL and CSA rated up to 600 V per UL 486
- UL Flammability UL 94V-2/HB, maximum insulation temperature 221°F (105°C)

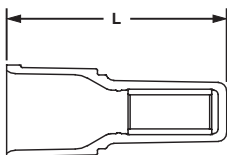

Part Number	Wire Range	Color Code	CMA Range		Figure Dimensions (In.)	Wire Strip Length (In.)	Recommended Installation Tool	Std. Pkg. Qty.**	Std. Ctn. Qty.
			Min.	Max.	L				
JN224-318-C	(2) #24 – (2) #16	Red	808	5160	.79	7/16	CT-1550‡, CT-1551‡, CT-2500‡	100	1000
JN218-216-C	(2) #22 – (2) #16	Clear	1284	5160	.78	7/16	CT-1550‡, CT-1551‡, CT-2500‡	100	1000
JN418-212-C	(4) #18 – (2) #12	Clear	6480	14750	.93	1/2	CT-100‡, CT-1550‡, CT-1551‡, CT-2500‡	100	1000
JN314-412-C*	(3) #14 – (4) #12	Clear	10320	26120	.97	5/8	CT-100, CT-160, CT-260	100	1000

*Not UL Listed.

**To order in bulk, replace -C in the part number with -M for a bulk package of 1000, with exception of JN418-212-C, replace -C with -D for bulk package of 500.

‡UL and CSA approved tooling/product combinations. For crimping tool information, see pages D1.83, D1.84, and D1.88.

Note: Wire combinations using #24 AWG wire are not UL Listed or CSA Certified.

A. System Overview

B1. Cable Ties

B2. Cable Accessories

B3. Stainless Steel Ties

C1. Wiring Duct

C2. Surface Raceway

C3. Abrasion Protection

C4. Cable Management

D1. Terminals

D2. Power Connectors

D3. Grounding Connectors

E1. Labeling Systems

E2. Labels

E3. Pre-Printed & Write-On Markers

E4. Permanent Identification

E5. Lockout/Tagout & Safety Solutions

F. Index

A. System Overview

B1. Cable Ties



Wire Joint, Non-Insulated

Type J

- Large barrel, designed to accommodate from one to seven wires with just one crimp
- Accommodates multiple wire sizes in varying combinations
- Non-insulated barrel can be used to provide an economical termination when insulation is not required
- Barrel of terminal internally beveled to provide quick and easy wire insertion
- Maximum recommended operating temperature 302°F (150°C)

B2. Cable Accessories

B3. Stainless Steel Ties

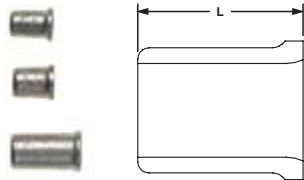

C1. Wiring Duct

C2. Surface Raceway

C3. Abrasion Protection



Heat Shrink, Butt Splices

Type BSH

- Designed to splice two solid or stranded wires together to repair or lengthen wires
- Butted configuration provides low profile for limited space applications
- Heat shrink polyolefin sleeve with hot melt adhesive protects against moisture
- After crimping, heat shrink insulation is completed with a standard heat gun
- Minimum continuous operating temperature -65°F (-55°C)
- Maximum continuous operation temperature 230°F (110°C)
- Shrink temperature 250°F (120°C)

C4. Cable Management

D1. Terminals



Part Number	Wire Range	Color Code	Max. Ins.	Figure Dimensions (In.)	Wire Strip Length (In.)	Recommended Installation Tool	Std. Pkg. Qty.**	Std. Ctn. Qty.
				L				
BSH18-Q	22 – 18 AWG	Red	.170	1.45	5/16	CT-310	25	125
BSH14-Q	16 – 14 AWG	Blue	.190	1.45	5/16	CT-310	25	125
BSH10-E	12 – 10 AWG	Yellow	.240	1.64	5/16	CT-310	20	100

**To order in bulk, replace -Q in the part number with -D for a bulk package of 500 and replace -E with -T for a bulk package of 200.
For crimping tool information, see page D1.85.

D2. Power Connectors

D3. Grounding Connectors

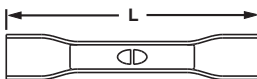

E1. Labeling Systems

Metric Butt Splice, Vinyl Insulated

Type BSMV

- Expanded wire entry designed to accommodate wire with a larger insulation thickness
- Designed to splice two solid or stranded wires together to repair or lengthen wires
- Brazed seam protects terminal barrel from splitting during the crimp process
- Internal wire stop assures proper length of insertion into terminal barrel

E2. Labels

E3. Pre-Printed & Write-On Markers



Part Number	Wire Range (mm²)	Color Code	Max Ins.	Figure Dimensions (mm)	Recommended Installation Tool	Std. Pkg. Qty.	Std. Ctn. Qty.
				L			
BSMV1BX-CY[^]	.5 – 1.5	Red	4.3	26.4	CT-1551	100	500
BSMV2BX-C[^]	1.5 – 2.5	Blue	5.1	26.4	CT-1551	100	500
BSMV6X-L[*]	2.5 – 6.0	Yellow	6.4	30.0	CT-1551	50	250

*Brazed seam.

**To order bulk, replace -C, or -CY in the part number with -M, or -MY for a bulk package of 1000 and replace -L with -D for bulk package of 500.

[^]Butted seam.

For crimping tool information, see page D1.84.

E4. Permanent Identification

E5. Lockout/Tagout & Safety Solutions

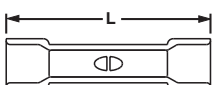

F. Index

Metric Butt Splice, Non-Insulated

Type BSM

- Designed to splice two solid or stranded wires together to repair or lengthen wires
- Butted configuration provides low profile for limited space applications
- Brazed seam protects terminal barrel from splitting during the crimp process
- Internal wire stop assures proper length of insertion into terminal barrel
- Maximum recommended operating temperature 302°F (150°C)
- Non-insulated barrel can be used to provide an economical termination when insulation is not required



Part Number	Wire Range (mm²)	Figure Dimensions (mm)	Recommended Installation Tool	Std. Pkg. Qty.	Std. Ctn. Qty.
		L			
BSM1-C	.5 – 1.5	15.7	CT-1570, CT-2500	100	500
BSM2-C	1.5 – 2.5	15.7		100	500
BSM6-L	2.5 – 6.0	18.2		50	250

For crimping tool information, see pages D1.84 and D1.88.

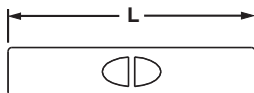

Metric Wire Joints, Nylon Insulated

Type JMN

- Large barrel, designed to accommodate from one to seven wires with just one crimp
- Accommodates multiple wire sizes in varying combinations
- Barrel of terminal internally beveled to provide quick and easy wire insertion



Part Number	Wire Range (mm²)	Color Code	CMA Range Min.	CMA Range Max.	Figure Dimensions (mm)	Recommended Installation Tool	Std. Pkg. Qty.	Std. Ctn. Qty.
					L			
JMN2-C	.5 – 2.5	Clear	1284	5160	19.9	CT-1551	100	500
JMN6-C	.75 – 6.0	Clear	6480	14750	23.9	CT-1551	100	500

For crimping tool information, see page D1.84.

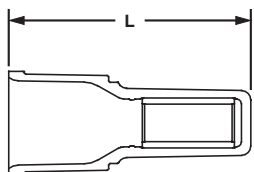

A.
System
Overview

B1.
Cable
Ties

B2.
Cable
Accessories

B3.
Stainless
Steel Ties

C1.
Wiring
Duct

C2.
Surface
Raceway

C3.
Abrasion
Protection

C4.
Cable
Management

D1.
Terminals

D2.
Power
Connectors

D3.
Grounding
Connectors

E1.
Labeling
Systems

E2.
Labels

E3.
Pre-Printed
& Write-On
Markers

E4.
Permanent
Identification

E5.
Lockout/
Tagout
& Safety
Solutions

F.
Index

A. System Overview

B1. Cable Ties

B2. Cable Accessories

B3. Stainless Steel Ties

C1. Wiring Duct

C2. Surface Raceway

C3. Abrasion Protection

C4. Cable Management

D1. Terminals

D2. Power Connectors

D3. Grounding Connectors

E1. Labeling Systems

E2. Labels

E3. Pre-Printed & Write-On Markers

E4. Permanent Identification

E5. Lockout/Tagout & Safety Solutions

F. Index

PAN-TERM® FERRULES

PANDUIT® PAN-TERM® Ferrule end sleeves terminate stranded wire into terminal blocks with superior termination performance. A wide assortment of ferrule styles and tool designs provide a proven way to make reliable connections, especially for limited space applications. Insulation flare allows for ease of wire insertion and eliminates loose strands of wire. Encapsulated crimp contains loose wires to eliminate stray wire breakage.



- Ideal for control panel and terminal block applications
- Insulated single wire range of #26 – 1 AWG, sizes meets French and DIN color code standards
- Insulated twin wire end sleeve range of #22 – 10 AWG, sizes meets DIN color code standard
- Non-insulated wire range of #24 – 1 AWG
- Insulated ferrules single wire range #20 – 14 AWG, available in strips of 50 for use with the semiautomatic ferrule crimping tool, CT-1000, for improved reliability and productivity
- Wide assortment of controlled cycle, crimping tools for reliable connections at the lowest installed cost

PANDUIT continually provides new designs to meet the application challenges encountered by our customers. PANDUIT offers a wide assortment of PAN-TERM® termination products to meet customer needs at the lowest installed cost.

Features and Benefits – PAN-TERM® Ferrules

PANDUIT ferrules are available for wiring applications from #26 – 1 AWG. Offerings include insulated and non-insulated ferrules, in single-wire or double-wire configurations. Insulated ferrules are color-coded to DIN or French standards. Crimped on the metal barrel these ferrules provide improved performance for terminal block and panel building applications.

<p style="text-align: center;">Insulated Ferrules – Single Wire Type FSF and FSD</p>	<p style="text-align: center;">Insulated Ferrules – Twin Wire Type FTD</p>
---	---

Non-Insulated Ferrules

Type F



PANDUIT provides a wide assortment of crimping tools for reliable connections at the lowest installed cost.

See page D1.85.



PANDUIT designs and manufactures a full line of labeling products, software, and printers to assist you with your labeling requirements.

See pages E1.1 – E2.30.

A.
System
Overview

B1.
Cable Ties

B2.
Cable
Accessories

B3.
Stainless
Steel Ties

C1.
Wiring
Duct

C2.
Surface
Raceway

C3.
Abrasion
Protection

C4.
Cable
Management

D1.
Terminals

D2.
Power
Connectors

D3.
Grounding
Connectors

E1.
Labeling
Systems

E2.
Labels

E3.
Pre-Printed
& Write-On
Markers

E4.
Permanent
Identification

E5.
Lockout/
Tagout
& Safety
Solutions

F.
Index

A.
System
Overview

Selection Guide – *PAN-TERM*® Ferrules

B1.
Cable Ties

B2.
Cable
Accessories

B3.
Stainless
Steel Ties

C1.
Wiring
Duct

C2.
Surface
Raceway

C3.
Abrasion
Protection

C4.
Cable
Management

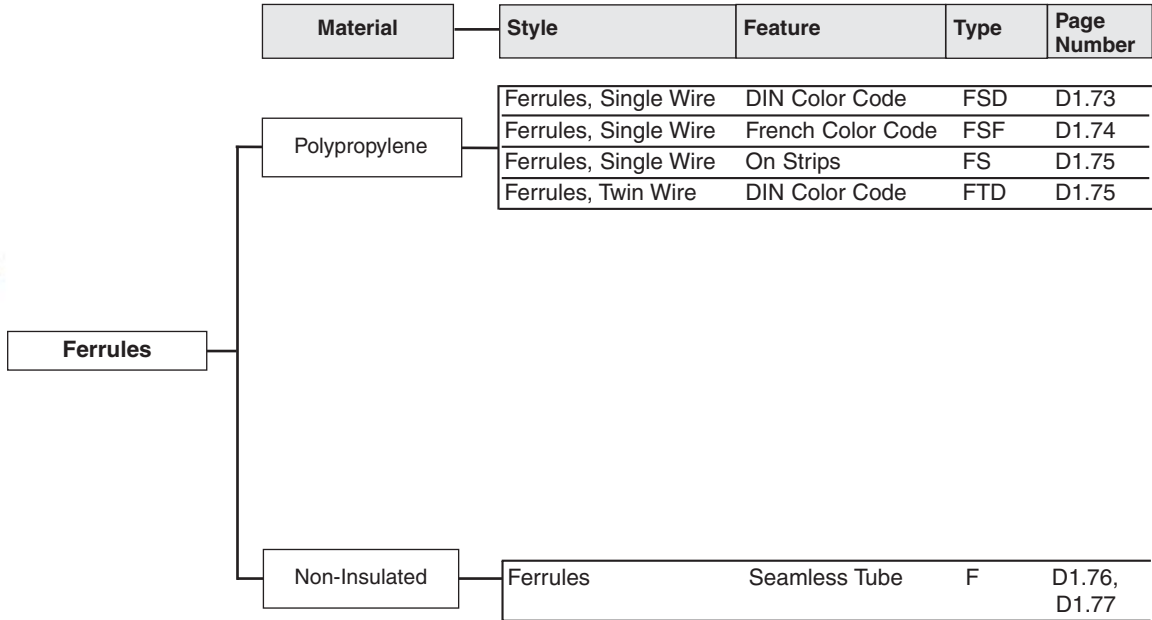

D1.
Terminals

Part Number System for *PAN-TERM*® Ferrules

D2.
Power
Connectors

D3.
Grounding
Connectors

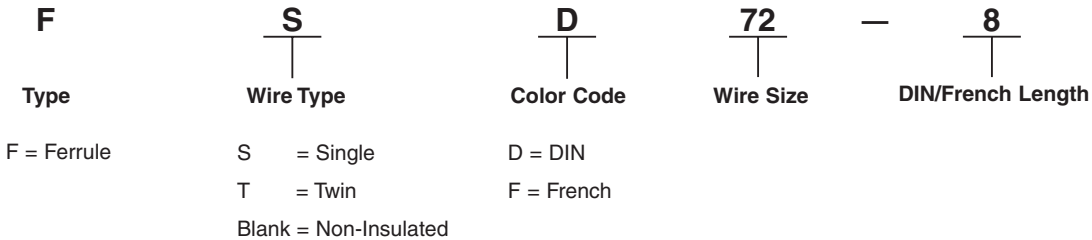

E1.
Labeling
Systems

E2.
Labels

E3.
Pre-Printed
& Write-On
Markers

E4.
Permanent
Identification

E5.
Lockout/
Tagout/
& Safety
Solutions

F.
Index

Insulated Ferrules – Single Wire DIN End Sleeve

Type FSD

- Polypropylene insulation housing conforms to DIN color requirements
- Meets DIN standards for single wire containment
- Funnel entry for faster insertion and lower installed cost
- Designed with a seamless barrel to contain loose wire strands for superior terminations
- Eases insertion of wire into terminal block
- Suitable for limited space panel applications
- Multiple pin lengths available for a variety of terminal blocks

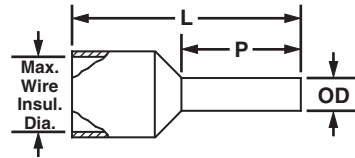

Part Number	Wire Size		Color Code	Max. Wire Insul. Dia.		Figure Dimensions						Wire Strip Length		Recommended Installation Tool	Std. Pkg. Qty.
	AWG	mm ²		In.	mm	L		P		OD		In.	mm		
FSD72-6-D	26 AWG	.14	Gray	.07	1.7	.41	10.5	.24	6.0	.05	1.3	3/8	9.5	CT-1002, CT-1123	500
FSD72-8-D				.07	1.7	.49	12.5	.31	8.0	.05	1.3	15/32	11.9		500
FSD73-6-D				.07	1.7	.41	10.5	.24	6.0	.05	1.3	3/8	9.5		500
FSD73-8-D	24 AWG	.25	Yellow	.07	1.7	.49	12.5	.31	8.0	.05	1.3	15/32	11.9	500	
FSD74-6-D			Turquoise	.07	1.7	.41	10.5	.24	6.0	.05	1.3	3/8	9.5	500	
FSD74-8-D				.07	1.7	.49	12.5	.31	8.0	.05	1.3	15/32	11.9	500	
FSD75-6-D	22 AWG	.50	White	.09	2.2	.45	11.5	.24	6.0	.06	1.4	3/8	9.5	500	
FSD75-8-D				.09	2.2	.53	13.5	.31	8.0	.06	1.4	15/32	11.9	500	
FSD75-10-D				.09	2.2	.61	15.5	.39	10.0	.06	1.4	17/32	13.5	500	
FSD76-6-D	20 AWG	.75	Gray	.09	2.4	.47	12.0	.24	6.0	.06	1.6	3/8	9.5	500	
FSD76-8-D				.09	2.4	.55	14.0	.31	8.0	.06	1.6	15/32	11.9	500	
FSD76-10-D				.09	2.4	.63	16.0	.39	10.0	.06	1.6	17/32	13.5	500	
FSD76-12-D				.09	2.4	.71	18.0	.47	12.0	.06	1.6	5/8	15.9	500	
FSD77-6-D	18 AWG	1.0	Red	.11	2.7	.49	12.5	.24	6.0	.07	1.8	3/8	9.5	500	
FSD77-8-D				.11	2.7	.57	14.5	.31	8.0	.07	1.8	15/32	11.9	500	
FSD77-10-D				.11	2.7	.65	16.5	.39	10.0	.07	1.8	17/32	13.5	500	
FSD77-12-D				.11	2.7	.73	18.5	.47	12.0	.07	1.8	5/8	15.9	500	
FSD78-6-D	16 AWG	1.5	Black	.12	3.0	.49	12.5	.24	6.0	.08	2.1	3/8	9.5	500	
FSD78-8-D				.12	3.0	.57	14.5	.31	8.0	.08	2.1	15/32	11.9	500	
FSD78-10-D				.12	3.0	.65	16.5	.39	10.0	.08	2.1	17/32	13.5	500	
FSD78-12-D				.12	3.0	.73	18.5	.47	12.0	.08	2.1	5/8	15.9	500	
FSD78-18-D				.12	3.0	.96	24.5	.71	18.0	.08	2.1	7/8	22.2	500	
FSD79-8-D	14 AWG	2.1	Yellow	.13	3.2	.57	14.5	.31	8.0	.09	2.4	15/32	11.9	500	
FSD80-8-D				.15	3.7	.59	15.0	.31	8.0	.10	2.6	15/32	11.9	500	
FSD80-12-D		2.5	Blue	.15	3.7	.75	19.0	.47	12.0	.10	2.6	5/8	15.9	500	
FSD80-18-D				.15	3.7	.98	25.0	.71	18.0	.10	2.6	7/8	22.2	500	
FSD81-10-D	12 AWG	4.0	Gray	.17	4.3	.69	17.5	.39	10.0	.13	3.3	17/32	13.5	500	
FSD81-12-C				.17	4.3	.79	20.0	.47	12.0	.13	3.3	5/8	15.9	100	
FSD81-18-C				.17	4.3	1.02	26.0	.71	18.0	.13	3.3	7/8	22.2	100	
FSD82-12-C	10 AWG	6.0	Yellow	.22	5.5	.79	20.0	.47	12.0	.16	4.0	5/8	15.9	100	
FSD82-18-C				.22	5.5	1.02	26.0	.71	18.0	.16	4.0	7/8	22.2	100	
FSD83-12-C	8 AWG	10.0	Red	.27	6.8	.83	21.0	.47	12.0	.20	5.0	5/8	15.9	100	
FSD83-18-C				.27	6.8	1.06	27.0	.71	18.0	.20	5.0	7/8	22.2	100	
FSD84-12-C	6 AWG	16.0	Blue	.32	8.2	.91	23.0	.47	12.0	.25	6.4	5/8	15.9	100	
FSD84-18-C				.32	8.2	1.14	29.0	.71	18.0	.25	6.4	7/8	22.2	100	
FSD85-16-L	4 AWG	25.0	Yellow	.41	10.3	1.14	29.0	.63	16.0	.31	7.9	3/4	19.1	50	
FSD85-18-L				.41	10.3	1.22	31.0	.71	18.0	.31	7.9	7/8	22.2	50	
FSD85-22-L				.41	10.3	1.38	35.0	.87	22.0	.31	7.9	1	25.4	50	
FSD86-16-L	2 AWG	35.0	Red	.45	11.5	1.18	30.0	.63	16.0	.35	8.9	3/4	19.1	50	
FSD86-18-L				.45	11.5	1.26	32.0	.71	18.0	.35	8.9	7/8	22.2	50	
FSD86-25-L				.45	11.5	1.54	39.0	.98	25.0	.35	8.9	1 1/8	28.6	50	
FSD87-20-L	1 AWG	50.0	Blue	.54	13.7	1.42	36.0	.79	20.0	.44	11.1	15/16	23.8	50	
FSD87-25-Q				.54	13.7	1.61	41.0	.98	25.0	.44	11.1	1 1/8	28.6	25	

For crimping tool information, see page D1.85

- A. System Overview
- B1. Cable Ties
- B2. Cable Accessories
- B3. Stainless Steel Ties
- C1. Wiring Duct
- C2. Surface Raceway
- C3. Abrasion Protection
- C4. Cable Management
- D1. Terminals
- D2. Power Connectors
- D3. Grounding Connectors
- E1. Labeling Systems
- E2. Labels
- E3. Pre-Printed & Write-On Markers
- E4. Permanent Identification
- E5. Lockout/Tagout & Safety Solutions
- F. Index

A. System Overview

Insulated Ferrules – Single Wire French End Sleeve Type FSF

B1. Cable Ties

- Polypropylene insulation housing conforms to French color requirements
- Meets DIN standards for single wire containment
- Funnel entry for faster insertion and lower installed cost
- Eases insertion of wire into terminal block
- Suitable for limited space panel applications

B2. Cable Accessories

- Designed with a seamless barrel to contain loose wire strands for superior terminations

B3. Stainless Steel Ties

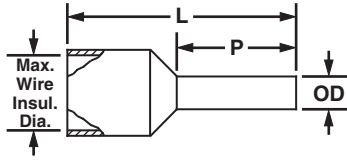

C1. Wiring Duct

C2. Surface Raceway

C3. Abrasion Protection

C4. Cable Management

D1. Terminals

D2. Power Connectors

D3. Grounding Connectors

E1. Labeling Systems

E2. Labels

E3. Pre-Printed & Write-On Markers

E4. Permanent Identification

E5. Lockout/Tagout & Safety Solutions

F. Index

Part Number	Wire Size		Color Code	Max. Wire Insul. Dia.		Figure Dimensions						Wire Strip Length		Recommended Installation Tool	Std. Pkg. Qty.
	AWG	mm ²		In.	mm	L		P		OD		In.	mm		
FSF72-6-D	26 AWG	.14	Brown	.07	1.7	.41	10.5	.24	6.0	.05	1.3	3/8	9.5	CT-1002, CT-1123	500
FSF72-8-D				.07	1.7	.49	12.5	.31	8.0	.05	1.3	15/32	11.9		500
FSF73-6-D	24 AWG	.25	Violet	.07	1.7	.41	10.5	.24	6.0	.05	1.3	3/8	9.5		500
FSF73-8-D				.07	1.7	.49	12.5	.31	8.0	.05	1.3	15/32	11.9		500
FSF74-6-D		.34	Pink	.07	1.7	.41	10.5	.24	6.0	.05	1.3	3/8	9.5		500
FSF74-8-D				.07	1.7	.49	12.5	.31	8.0	.05	1.3	15/32	11.9		500
FSF75-6-D	22 AWG	.50	White	.09	2.2	.45	11.5	.24	6.0	.06	1.4	3/8	9.5	500	
FSF75-8-D				.09	2.2	.53	13.5	.31	8.0	.06	1.4	15/32	11.9	500	
FSF75-10-D				.09	2.2	.61	15.5	.39	10.0	.06	1.4	17/32	13.5	500	
FSF76-6-D	20 AWG	.75	Blue	.09	2.4	.47	12.0	.24	6.0	.06	1.6	3/8	9.5	500	
FSF76-8-D				.09	2.4	.55	14.0	.31	8.0	.06	1.6	15/32	11.9	500	
FSF76-10-D				.09	2.4	.63	16.0	.39	10.0	.06	1.6	17/32	13.5	500	
FSF76-12-D				.09	2.4	.71	18.0	.47	12.0	.06	1.6	5/8	15.9	500	
FSF77-6-D	18 AWG	1.0	Red	.11	2.7	.49	12.5	.24	6.0	.07	1.8	3/8	9.5	500	
FSF77-8-D				.11	2.7	.57	14.5	.31	8.0	.07	1.8	15/32	11.9	500	
FSF77-10-D				.11	2.7	.65	16.5	.39	10.0	.07	1.8	17/32	13.5	500	
FSF77-12-D	16 AWG	1.5	Black	.11	2.7	.73	18.5	.47	12.0	.07	1.8	5/8	15.9	500	
FSF78-6-D				.12	3.0	.49	12.5	.24	6.0	.08	2.1	3/8	9.5	CT-1002, CT-1003, CT-1123	500
FSF78-8-D				.12	3.0	.57	14.5	.31	8.0	.08	2.1	15/32	11.9		500
FSF78-10-D				.12	3.0	.65	16.5	.39	10.0	.08	2.1	17/32	13.5		500
FSF78-12-D	.12	3.0	.73	18.5	.47	12.0	.08	2.1	5/8	15.9	500				
FSF78-18-D	14 AWG	2.1	Yellow	.12	3.0	.96	24.5	.71	18.0	.08	2.1	7/8	22.2	500	
FSF79-8-D				.13	3.2	.57	14.5	.31	8.0	.09	2.4	15/32	11.9	500	
FSF80-8-D				.15	3.7	.59	15.0	.31	8.0	.10	2.6	15/32	11.9	500	
FSF80-12-D	2.5	Gray	.15	3.7	.75	19.0	.47	12.0	.10	2.6	5/8	15.9	500		
FSF80-18-D			.15	3.7	.98	25.0	.71	18.0	.10	2.6	7/8	22.2	500		
FSF81-10-D	12 AWG	4.0	Orange	.17	4.3	.69	17.5	.39	10.0	.13	3.3	17/32	13.5	500	
FSF81-12-C				.17	4.3	.79	20.0	.47	12.0	.13	3.3	5/8	15.9	100	
FSF81-18-C				.17	4.3	1.02	26.0	.71	18.0	.13	3.3	7/8	22.2	100	
FSF82-12-C	10 AWG	6.0	Green	.22	5.5	.79	20.0	.47	12.0	.16	4.0	5/8	15.9	100	
FSF82-18-C				.22	5.5	1.02	26.0	.71	18.0	.16	4.0	7/8	22.2	100	
FSF83-12-C	8 AWG	10.0	Brown	.27	6.8	.83	21.0	.47	12.0	.20	5.0	5/8	15.9	CT-1003, CT-1004, CT-1123	100
FSF83-18-C				.27	6.8	1.06	27.0	.71	18.0	.20	5.0	7/8	22.2		100
FSF84-12-C	6 AWG	16.0	White	.32	8.2	.91	23.0	.47	12.0	.25	6.4	5/8	15.9	CT-1004	100
FSF84-18-C				.32	8.2	1.14	29.0	.71	18.0	.25	6.4	7/8	22.2		100
FSF85-16-L	4 AWG	25.0	Black	.41	10.3	1.14	29.0	.63	16.0	.31	7.9	3/4	19.1	50	
FSF85-18-L				.41	10.3	1.22	31.0	.71	18.0	.31	7.9	7/8	22.2	50	
FSF85-22-L				.41	10.3	1.38	35.0	.87	22.0	.31	7.9	1	25.4	50	
FSF86-16-L	2 AWG	35.0	Red	.45	11.5	1.18	30.0	.63	16.0	.35	8.9	3/4	19.1	50	
FSF86-18-L				.45	11.5	1.26	32.0	.71	18.0	.35	8.9	7/8	22.2	50	
FSF86-25-L				.45	11.5	1.54	39.0	.98	25.0	.35	8.9	1 1/8	28.6	50	
FSF87-20-L	1 AWG	50.0	Blue	.54	13.7	1.42	36.0	.79	20.0	.44	11.1	15/16	23.8	CT-1006	50
FSF87-25-Q				.54	13.7	1.61	41.0	.98	25.0	.44	11.1	1 1/8	28.6		25

For crimping tool information, see page D1.85.

Insulated Ferrules – Twin Wire DIN End Sleeve

Type FTD

- Meets DIN standards for twin wire containment
- Polypropylene insulation housing conforms to DIN color requirements
- Funnel entry for faster insertion and lower installed cost
- Designed with a seamless barrel to contain loose wire strands for superior terminations

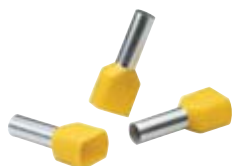

- Eases insertion of wire into terminal block
- Suitable for limited space panel applications
- Multiple pin lengths available for a variety of terminal blocks

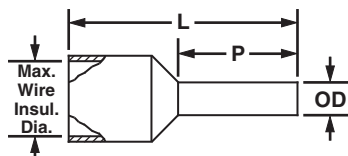

Part Number	Wire Size		Color Code	Max. Wire Insul. Dia.		Figure Dimensions						Wire Strip Length	Recommended Installation Tool	Std. Pkg. Qty.	
	AWG	mm²		In.	mm	L		P		OD					
FTD75-8-D	22 AWG	.50	White	.87	2.2	.59	15.0	.31	8.0	.07	1.8	7/16	11.2	CT-1002, CT-1003, CT-1123	500
FTD76-8-D	20 AWG	.75	Gray	.09	2.4	.59	15.0	.31	8.0	.08	2.1	7/16	11.2		500
FTD76-10-D				.09	2.4	.67	17.0	.39	10.0	.08	2.1	9/16	14.0		500
FTD77-8-D	18 AWG	1.0	Red	.11	2.7	.59	15.0	.31	8.0	.09	2.4	7/16	11.2		500
FTD77-10-D				.11	2.7	.67	17.0	.39	10.0	.09	2.4	9/16	14.0		500
FTD78-8-D	16 AWG	1.5	Black	.12	3.0	.63	16.0	.31	8.0	.10	2.6	7/16	11.2		500
FTD78-12-D				.12	3.0	.79	20.0	.47	12.0	.10	2.6	21/32	16.8		500
FTD80-10-TL	14 AWG	2.5	Blue	.15	3.7	.73	18.5	.39	10.0	.13	3.3	9/16	14.0		250
FTD80-13-TL				.15	3.7	.85	21.5	.51	13.0	.13	3.3	23/32	16.2		250
FTD81-12-C	12 AWG	4.0	Gray	.17	4.3	.91	23.0	.47	12.0	.17	4.2	21/32	16.8		100
FTD82-14-C	10 AWG	6.0	Yellow	.19	4.8	.98	25.0	.55	14.0	.20	5.0	25/32	19.6	CT-1003, CT-1004	100

For crimping tool information, see page D1.85.

Insulated Ferrules on Strips – Single Wire

Type FS

- Polypropylene insulation housing available in DIN standard colors in strips of 50
- Continuously molded design provides consistent placement of ferrules in tool to ensure fast, reliable terminations

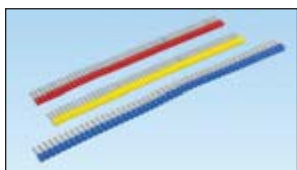

- Available in #20 – 14 AWG featuring a seamless barrel design to contain loose wire strands for superior terminations
- Designed for use with the Semiautomatic Ferrule Crimping Tool CT-1000 for medium volume applications

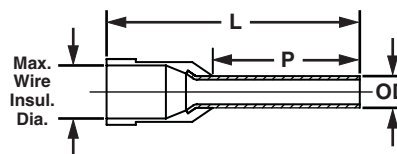

Part Number	Wire Size		Color Code	Max. Wire Insul. Dia.		Figure Dimensions						Wire Strip Length	Recommended Installation Tool	Std. Pkg. Qty.	
	AWG	mm²		In.	mm	L		P		OD					
DIN End Sleeves															
FSD75-8-DSL10	20 AWG	.50	White	.10	2.6	.60	15.2	.31	8.0	.05	1.4	13/32	10	CT-1000	500
FSD76-8-DSL8	18 AWG	.75	Gray	.11	2.7	.60	15.2	.31	8.0	.07	1.8	13/32	10		500
FSD77-8-DSL2		1.00	Red	.12	3.0	.60	15.2	.31	8.0	.08	2.1	13/32	10		500
FSD78-8-DSL0	16 AWG	1.50	Black	.13	3.2	.60	15.2	.31	8.0	.10	2.6	13/32	10		500
FSD80-8-DSL6	14 AWG	2.50	Blue	.16	4.0	.60	15.2	.31	8.0	.10	2.6	13/32	10		500
Additional Colored End Sleeves															
FS75-8-DSL3	20 AWG	.50	Orange	.10	2.6	.60	15.2	.31	8.0	.05	1.4	13/32	10	CT-1000	500
FS76-8-DSL10	18 AWG	.75	White	.11	2.7	.60	15.2	.31	8.0	.06	1.6	13/32	10		500
FS76-8-DSL7			Light Blue	.11	2.7	.60	15.2	.31	8.0	.06	1.6	13/32	10		500
FS77-8-DSL4			1.00	Yellow	.12	3.0	.60	15.2	.31	8.0	.07	1.8	13/32		10
FS78-8-DSL2	16 AWG	1.50	Red	.13	3.2	.60	15.2	.31	8.0	.08	2.1	13/32	10		500
FS80-8-DSL8	14 AWG	2.50	Gray	.16	4.0	.60	15.2	.31	8.0	.10	2.6	13/32	10		500

For crimping tool information, see page D1.86.

A. System Overview

B1. Cable Ties

B2. Cable Accessories

B3. Stainless Steel Ties

C1. Wiring Duct

C2. Surface Raceway

C3. Abrasion Protection

C4. Cable Management

D1. Terminals

D2. Power Connectors

D3. Grounding Connectors

E1. Labeling Systems

E2. Labels

E3. Pre-Printed & Write-On Markers

E4. Permanent Identification

E5. Lockout/Tagout & Safety Solutions

F. Index

A. System Overview

Ferrules, Non-Insulated

B1. Cable Ties

Type F

B2. Cable Accessories

- Designed with a seamless barrel to contain loose wire strands for superior terminations
- Eases insertion of wire into terminal block
- Meets DIN standards for wire containment
- Suitable for limited space panel applications
- Multiple pin lengths available for a variety of terminal blocks

B3. Stainless Steel Ties

C1. Wiring Duct

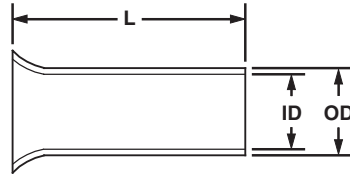

C2. Surface Raceway

C3. Abrasion Protection

C4. Cable Management

D1. Terminals

D2. Power Connectors

D3. Grounding Connectors

E1. Labeling Systems

E2. Labels

E3. Pre-Printed & Write-On Markers

E4. Permanent Identification

E5. Lockout/Tagout & Safety Solutions

F. Index

Part Number	Wire Size		Figure Dimensions						Wire Strip Length		Recommended Installation Tool	Std. Pkg. Qty.
			L		ID		OD					
	AWG	mm ²	In.	mm	In.	mm	In.	mm	In.	mm		
F73-5-M	24 AWG	.25	.20	5.0	.03	.80	.04	1.1	7/32	5.0	CT-1002, CT-1003	1000
F73-7-M			.28	7.0	.03	.80	.04	1.1	9/32	7.0		1000
F74-5-M		.34	.20	5.0	.04	.90	.05	1.2	7/32	5.0		1000
F74-7-M			.28	7.0	.04	.90	.05	1.2	9/32	7.0		1000
F75-6-M	22 AWG	.50	.24	6.0	.04	1.0	.05	1.3	1/4	6.0	CT-1002, CT-1003, CT-1123	1000
F75-8-M			.31	8.0	.04	1.0	.05	1.3	5/16	8.0		1000
F75-10-M			.39	10.0	.04	1.0	.05	1.3	13/32	10.0		1000
F76-6-M	20 AWG	.75	.24	6.0	.05	1.2	.06	1.5	1/4	6.0	CT-1002, CT-1003, CT-1123	1000
F76-8-M			.31	8.0	.05	1.2	.06	1.5	5/16	8.0		1000
F76-10-M			.39	10.0	.05	1.2	.06	1.5	13/32	10.0		1000
F76-12-M			.47	12.0	.05	1.2	.06	1.5	15/32	12.0		1000
F77-6-M	18 AWG	1.0	.24	6.0	.06	1.4	.07	1.7	1/4	6.0	CT-1002, CT-1003, CT-1123	1000
F77-7-M			.28	7.0	.06	1.4	.07	1.7	9/32	7.0		1000
F77-8-M			.31	8.0	.06	1.4	.07	1.7	5/16	8.0		1000
F77-10-M			.39	10.0	.06	1.4	.07	1.7	13/32	10.0		1000
F77-12-M	16 AWG	1.5	.47	12.0	.06	1.4	.07	1.7	15/32	12.0	CT-1002, CT-1003, CT-1123	1000
F78-7-M			.28	7.0	.07	1.7	.08	2.0	9/32	7.0		1000
F78-8-M			.31	8.0	.07	1.7	.08	2.0	5/16	8.0		1000
F78-10-M			.39	10.0	.07	1.7	.08	2.0	13/32	10.0		1000
F78-12-M	14 AWG	2.5	.47	12.0	.07	1.7	.08	2.0	15/32	12.0	CT-1002, CT-1003	1000
F78-15-M			.59	15.0	.07	1.7	.08	2.0	19/32	15.0		1000
F78-18-M			.71	18.0	.07	1.7	.08	2.0	23/32	18.0		1000
F78-20-M			.79	20.0	.07	1.7	.08	2.0	25/32	20.0		1000
F80-7-M	14 AWG	2.5	.28	7.0	.09	2.2	.10	2.5	9/32	7.0	CT-1002, CT-1003	1000
F80-8-M			.31	8.0	.09	2.2	.10	2.5	5/16	8.0		1000
F80-10-M			.39	10.0	.09	2.2	.10	2.5	13/32	10.0		1000
F80-12-M			.47	12.0	.09	2.2	.10	2.5	15/32	12.0		1000
F80-15-M			.59	15.0	.09	2.2	.10	2.5	19/32	15.0		1000
F80-18-M			.71	18.0	.09	2.2	.10	2.5	23/32	18.0		1000
F80-20-M			.79	20.0	.09	2.2	.10	2.5	25/32	20.0		1000

For crimping tool information, see page D1.85.

Ferrules, Non-Insulated (continued)

Type F

Part Number	Wire Size		Figure Dimensions						Wire Strip Length		Recommended Installation Tool	Std. Pkg. Qty.
			L		ID		OD					
	AWG	mm ²	In.	mm	In.	mm	In.	mm	In.	mm		
F81-9-M	12 AWG	4.0	.35	9.0	.11	2.8	.13	3.3	11/32	8.0	CT-1002, CT-1003, CT-1123	1000
F81-10-M			.39	10.0	.11	2.8	.13	3.3	13/32	10.0		1000
F81-12-M			.47	12.0	.11	2.8	.13	3.3	15/32	12.0		1000
F81-15-M			.59	15.0	.11	2.8	.13	3.3	19/32	15.0		1000
F81-18-M			.71	18.0	.11	2.8	.13	3.3	23/32	18.0		1000
F81-20-M			.79	20.0	.11	2.8	.13	3.3	25/32	20.0		1000
F82-10-M	10 AWG	6.0	.39	10.0	.14	3.5	.15	3.9	13/32	10.0	CT-1003, CT-1004, CT-1123	1000
F82-12-M			.47	12.0	.14	3.5	.15	3.9	15/32	12.0		1000
F82-15-M			.59	15.0	.14	3.5	.15	3.9	19/32	15.0		1000
F82-18-M			.71	18.0	.14	3.5	.15	3.9	23/32	18.0		1000
F82-20-M			.79	20.0	.14	3.5	.15	3.9	25/32	20.0		1000
F83-12-D	8 AWG	10.0	.47	12.0	.18	4.5	.19	4.9	15/32	12.0	CT-1003, CT-1004, CT-1123	500
F83-15-D			.59	15.0	.18	4.5	.19	4.9	19/32	15.0		500
F83-18-D			.71	18.0	.18	4.5	.19	4.9	23/32	18.0		500
F83-20-D			.79	20.0	.18	4.5	.19	4.9	25/32	20.0		500
F83-25-D			.98	25.0	.18	4.5	.19	4.9	31/32	25.0		500
F84-12-TL	6 AWG	16.0	.47	12.0	.23	5.8	.24	6.2	15/32	12.0	CT-1004	250
F84-15-TL			.59	15.0	.23	5.8	.24	6.2	19/32	15.0		250
F84-18-TL			.71	18.0	.23	5.8	.24	6.2	23/32	18.0		250
F84-20-TL			.79	20.0	.23	5.8	.24	6.2	25/32	20.0		250
F84-25-TL			.98	25.0	.23	5.8	.24	6.2	31/32	25.0		250
F84-32-TL			1.26	32.0	.23	5.8	.24	6.2	1 1/4	32.0		250
F85-12-C	4 AWG	25.0	.47	12.0	.29	7.3	.30	7.7	15/32	12.0	CT-1005	100
F85-15-C			.59	15.0	.29	7.3	.30	7.7	19/32	15.0		100
F85-18-C			.71	18.0	.29	7.3	.30	7.7	23/32	18.0		100
F85-25-C			.98	25.0	.29	7.3	.30	7.7	31/32	25.0		100
F85-32-C			1.26	32.0	.29	7.3	.30	7.7	1 1/4	32.0		100
F86-18-C	2 AWG	35.0	.71	18.0	.33	8.3	.34	8.7	23/32	18.0	CT-1006	100
F86-20-C			.79	20.0	.33	8.3	.34	8.7	25/32	20.0		100
F86-25-C			.98	25.0	.33	8.3	.34	8.7	31/32	25.0		100
F86-32-C			1.26	32.0	.33	8.3	.34	8.7	1 1/4	32.0		100
F87-18-C	1 AWG	50.0	.71	18.0	.41	10.3	.43	10.9	23/32	18.0	CT-1006	100
F87-22-C			.87	22.0	.41	10.3	.43	10.9	7/8	22.0		100
F87-25-C			.98	25.0	.41	10.3	.43	10.9	31/32	25.0		100
F87-32-C			1.26	32.0	.41	10.3	.43	10.9	1 1/4	32.0		100

For crimping tool information, see page D1.85.

A.
System
Overview

B1.
Cable Ties

B2.
Cable
Accessories

B3.
Stainless
Steel Ties

C1.
Wiring
Duct

C2.
Surface
Raceway

C3.
Abrasion
Protection

C4.
Cable
Management

D1.
Terminals

D2.
Power
Connectors

D3.
Grounding
Connectors

E1.
Labeling
Systems

E2.
Labels

E3.
Pre-Printed
& Write-On
Markers

E4.
Permanent
Identification

E5.
Lockout/
Tagout
& Safety
Solutions

F.
Index

A.
System
Overview

Ferrule Assortment Kits

B1.
Cable Ties

- Large selection of ferrules in a convenient compact case
- Plastic case is both durable and reusable keeping ferrules organized and separated

B2.
Cable
Accessories



KP-FSD1, KP-FSD2,
and KP-FSD3

B3.
Stainless
Steel Ties

C1.
Wiring
Duct

C2.
Surface
Raceway



KP-F1 and KP-F2

C3.
Abrasion
Protection

C4.
Cable
Management

Part Number	Part Description	Std. Pkg. Qty.
KP-FSD1	Ferrule kit includes: #24 – 18 AWG insulated DIN ferrules. Case includes: 30 pieces each of FSD73-6, FSD74-6, FSD75-8, FSD76-8 and FSD77-8.	1
KP-FSD2	Ferrule kit includes: #22 – 14 AWG insulated DIN ferrules. Case includes: 100 pieces each of FSD76-8, FSD77-8, FSD78-8 50 pieces each of FSD75-8 and FSD80-8.	1
KP-FSD3	Ferrule kit includes: #12 – 6 AWG insulated DIN ferrules. Case includes: 50 pieces of FSD81-10 20 pieces each of FSD82-12 and FSD83-12 10 pieces of FSD84-12.	1
KP-F1	Ferrule kit includes: #22 – 14 AWG non-insulated ferrules. Case includes: 500 pieces of F75-6 400 pieces each of F76-6 and F77-6 300 pieces of F78-7 200 pieces of F80-7.	1
KP-F2	Ferrule kit includes: #12 – 6 AWG non-insulated ferrules. Case includes: 150 pieces of F81-9 100 pieces of F82-10 80 pieces of F83-12 40 pieces of F84-12.	1

Ferrule kits do not include crimping tool.

D1.
Terminals

D2.
Power
Connectors

D3.
Grounding
Connectors

E1.
Labeling
Systems

E2.
Labels

E3.
Pre-Printed
& Write-On
Markers

E4.
Permanent
Identification

E5.
Lockout/
Tagout/
& Safety
Solutions

F.
Index

TERMINAL CRIMPING TOOLS

PANDUIT offers a wide assortment of tools to provide solutions for installing terminals, disconnects, splices, ferrules and lugs. PANDUIT installation tools provide quality performance and ease of installation at the lowest installed cost. The long-term reliability of PANDUIT installation tools provides the highest level of service to meet customer requirements.



- Ergonomic design to minimize operator effort
- Features crimping tools with a controlled cycle mechanism ensuring repeat reliability in every crimp
- Superior locator ensures proper location of the terminal barrel or insulated disconnect in the crimp pocket
- Battery powered, hydraulic tools with fingertip operation are available to meet a variety of installation needs
- UL Listed and CSA Certified tooling/product combinations, as noted

PANDUIT terminal crimping tools are available in an assortment of styles to meet a variety of installation needs. The installer can control the crimp with the plier type hand operated crimping tool. Hand operated *CONTOUR CRIMP™* Controlled Cycle Crimping Tools feature ergonomically designed cushioned grips with low handle effort. PANDUIT terminal crimping tools are designed for use with PANDUIT terminals, providing the right solution for your termination needs.

A.
System
Overview

B1.
Cable
Ties

B2.
Cable
Accessories

B3.
Stainless
Steel
Ties

C1.
Wiring
Duct

C2.
Surface
Raceway

C3.
Abrasion
Protection

C4.
Cable
Management

D1.
Terminals

D2.
Power
Connectors

D3.
Grounding
Connectors

E1.
Labeling
Systems

E2.
Labels

E3.
Pre-Printed
& Write-On
Markers

E4.
Permanent
Identification

E5.
Lockout/
Tagout/
& Safety
Solutions

F.
Index

A. System Overview

Crimping Guidelines for PANDUIT® PAN-TERM® Terminals, Disconnects, Splices and Wire Joints

B1. Cable Ties

1. Select the proper PANDUIT terminal for the application and wire size used

- Ring terminals are used for high vibration and grounding applications
- Fork terminals are used for static (non-vibration) applications
- Disconnects are used for applications that require quick connection of wires without the use of tools
- Splices and wire joints are used to join wires together



B2. Cable Accessories

B3. Stainless Steel Ties

2. Strip wire to the proper length as specified on:

- PANDUIT product packaging label
- Packaging instructions included with the PANDUIT product
- Or if no packaging instructions are available, plan your strip length so that 1/32" of wire can be seen protruding through the tongue end of the terminal barrel

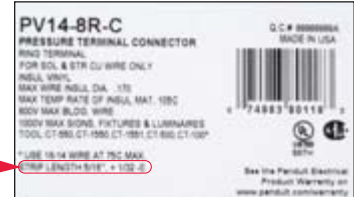

C1. Wiring Duct

C2. Surface Raceway

3. Select the proper crimp tool to be used

- Use crimping tools that provide a UL Listed and/or CSA Certified electrical termination, to assure a safe and reliable connection
- PANDUIT terminals are UL Listed and CSA Certified when crimped with PANDUIT plier type crimping tool or with the preferred *CONTOUR CRIMP™* Controlled Cycle Crimping Tool specified on the packaging label

C3. Abrasion Protection

C4. Cable Management



Plier Type Crimping Tool



CONTOUR CRIMP™ Controlled Cycle Crimping Tool

D1. Terminals

4. Select the proper crimp pocket for the terminals and wire size you are using

- PANDUIT crimping tools simplify this process with color-coded crimp pockets. The yellow, blue, and red pockets are specifically designed for the industry standard barrel sizes, each with a specific color code.

D2. Power Connectors

D3. Grounding Connectors



E1. Labeling Systems

5. Perform the electrical crimp for the plier type tool Insulated Terminals and Disconnects

- Locate terminal in appropriate size color-coded crimp die pocket with tool centered on insulation sleeve. (See Note 1, page D1.82)
- Rotate terminal so tongue is level with crimp die.
- Insert properly stripped wire into terminal until a minimum of 1/32" of wire extends beyond the terminal barrel.
- Squeeze tool handles firmly to perform the electrical crimp. (See Note 2, page D1.82)
- Provide second crimp on the flared portion of the insulation housing to close the insulation as shown. Caution: When using plier type crimping tools, do not squeeze as firmly as you did for the electrical crimp. (See Note 3, page D1.82)



Step A



Step B



Steps C and D



Step E



Complete Crimp

E2. Labels

E3. Pre-Printed & Write-On Markers

E4. Permanent Identification

E5. Lockout/Tagout & Safety Solutions

F. Index

Crimping Guidelines for PANDUIT® PAN-TERM® Terminals, Disconnects, Splices and Wire Joints (continued)

Non-Insulated Terminals and Disconnects

- Locate terminal in appropriate wire gauge crimp die pocket with indenter centered on barrel seam.
- Rotate terminal so tongue is level with crimp die.
- Insert properly stripped wire (based on recommendations on package label) into terminal until a minimum of 1/32" of wire extends beyond the terminal barrel.
- Squeeze tool handles firmly to perform the electrical crimp. (See Note 2, page D1.82)



Step A



Step B



Steps C and D



Complete Crimp

Insulated and Non-Insulated Parallel Splices

- Locate parallel splice in appropriate wire gauge crimp die pocket and position tool on the center of the splice.
- Rotate terminal so tongue is level with crimp die.
- Insert properly stripped wire (based on recommendations on package label) into each end of the parallel splice.
- Squeeze tool handles firmly. (See Note 2, page D1.82)
- An insulation crimp is not required on an insulated parallel splice.

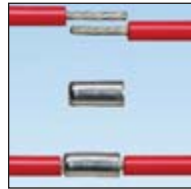

Steps A and B



Steps C and D



Complete Crimp

Insulated and Non-Insulated Butt Splices

- Locate butt splice in appropriate color-coded crimp die pocket and position crimp halfway between the wire stop (center of splice) and the end of the insulation crimp area. (See Note 4, page D1.82)
- Insert properly stripped wire (based on recommendations on package label) into one end of butt splice.
- Squeeze tool handles firmly to perform the electrical crimp (See Note 2, page D1.82)
- Provide second crimp on the flared portion of the insulation housing to close the insulation. Caution: When using plier type crimping tools, do not squeeze as firmly as you did for the electrical crimp. (See Note 3, page D1.82)
- Repeat steps 1 – 4 for opposite end of butt splice. (See Note 3, page D1.82)



Steps A and B



Step C

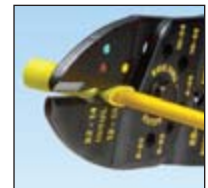

Steps D and E



Complete Crimp

A.
System
Overview

B1.
Cable
Ties

B2.
Cable
Accessories

B3.
Stainless
Steel Ties

C1.
Wiring
Duct

C2.
Surface
Raceway

C3.
Abrasion
Protection

C4.
Cable
Management

D1.
Terminals

D2.
Power
Connectors

D3.
Grounding
Connectors

E1.
Labeling
Systems

E2.
Labels

E3.
Pre-Printed
& Write-On
Markers

E4.
Permanent
Identification

E5.
Lockout/
Tagout
& Safety
Solutions

F.
Index

A.
System
Overview

B1.
Cable Ties

B2.
Cable
Accessories

B3.
Stainless
Steel Ties

C1.
Wiring
Duct

C2.
Surface
Raceway

C3.
Abrasion
Protection

C4.
Cable
Management

D1.
Terminals

D2.
Power
Connectors

D3.
Grounding
Connectors

E1.
Labeling
Systems

E2.
Labels

E3.
Pre-Printed
& Write-On
Markers

E4.
Permanent
Identification

E5.
Lockout/
Tagout/
& Safety
Solutions

F.
Index

Crimping Guidelines for PANDUIT® PAN-TERM® Terminals, Disconnects, Splices and Wire Joints (continued)

Insulated and Non-Insulated Wire Joints

- Properly strip wires per manufacturer's recommendations on product package label.
- Twist stripped wire ends together and insert wires into wire joint.
- Locate wire joint in appropriate wire gauge crimp die pocket and position crimp in the center of the metal insert.
- Squeeze tool handles firmly to perform the electrical crimp. (See Note 2 below)

Note: An insulation crimp is not required on an insulated wire joint.



Steps A and B

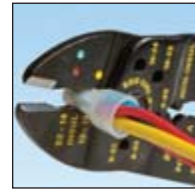

Steps C and D



Complete Crimp

NOTES for Crimping with the Preferred Hand Operated Controlled Cycle Crimping Tools:

- PANDUIT controlled cycle crimping tools properly locate rings, forks, and barrel insulated disconnects, pins, and blades. No further positioning is required.
- When using the preferred controlled cycle tool, once a crimp has been started, the ratchet device of controlled cycle tools will not release until the crimp is complete, independent of operator expertise.
- Controlled cycle tools provide the electrical crimp and the insulation closure in a single cycle of the tool.
- When using controlled cycle tooling, insulated butt splices must be inserted from the back of the tool to ensure that the electrical and insulation closure crimp pockets are properly aligned with the splice.

5. Perform the electrical crimp using the preferred controlled cycle tool

- Make sure the terminal barrel is centered correctly in the right die pocket by using the product locator on the backside of the tool.
- Determine the correct die pocket to use based on the color code of the terminal.
- Squeeze the handles of the tool until one click is heard; this click indicates the terminal is now held in place securely to insert the wire.
- Insert the wire and complete cycle to perform the electrical and insulation crimp simultaneously.
- Crimp is complete.



Step A



Step B



Step C



Step D



Complete Crimp

6. Inspect the crimp

Note: If your crimp looks like any of the examples shown below, cut off the terminal and recrimp. These crimps would provide a poor connection!



Bent Back Strands



Over Crimp



Rotated Crimp

Hand Operated Plier Type Tools

- Installer controlled crimp
- Available with wire stripping and cutting features
- Plier type crimp for #22 – 10 AWG insulated and non-insulated terminal products



CT-260



CT-200



CT-160



CT-100

Part Number	Part Description	Std. Pkg. Qty.
CT-260	Crimps most <i>PANDUIT</i> #22 – 10 AWG insulated and non-insulated terminals. Forged steel tool. Cuts wire.	1
CT-200	Forged steel tool. Crimps most <i>PANDUIT</i> #22 – 10 AWG non-insulated terminals, disconnects, and splices. Cuts wire.	1
CT-160	Crimps most <i>PANDUIT</i> #22 – 10 AWG insulated and non-insulated terminals disconnects, and splices. Cuts three U.S. and three metric screw sizes. Cuts and strips wire. Has insulation closure pocket.	1
CT-100	Crimps most <i>PANDUIT</i> #22 – 10 AWG insulated and non-insulated terminals, disconnects, and splices. Cuts #4, #6, #8 and #10 screw sizes. Cuts and strips wire. Excellent all-around application tool of heat treated finished steel with comfortable cushioned plastic grip handles.	1

Wire and Cable Stripping Tools

- Strips and cuts #20 – 10 AWG wire
- Lightweight and durable for comfortable long use
- Rust resistant coating included to improve durability of tool



Part Number	Wire Range (O.D.)	Part Description	Std. Pkg. Qty.
CST115	#20 – 10 AWG	Plier nose wire stripper.	1

A.
System
Overview

B1.
Cable Ties

B2.
Cable
Accessories

B3.
Stainless
Steel Ties

C1.
Wiring
Duct

C2.
Surface
Raceway

C3.
Abrasion
Protection

C4.
Cable
Management

D1.
Terminals

D2.
Power
Connectors

D3.
Grounding
Connectors

E1.
Labeling
Systems

E2.
Labels

E3.
Pre-Printed
& Write-On
Markers

E4.
Permanent
Identification

E5.
Lockout/
Tagout/
& Safety
Solutions

F.
Index

A. System Overview

CONTOUR CRIMP™ Controlled Cycle Tools

B1. Cable Ties

- Specifically designed for the installation of *PAN-TERM*® terminals, disconnects, and splices

- Polypropylene handles provide chemical resistance and a cushioned, non-slip grip

B2. Cable Accessories

- Controlled cycle mechanism assures high quality, consistent terminations

- Multiple position locator facilitates a high quality repeatable crimp

B3. Stainless Steel Ties



CT-1525

C1. Wiring Duct



CT-1550

C2. Surface Raceway



CT-1551

C3. Abrasion Protection



CT-1570

C4. Cable Management



CT-1700

D1. Terminals



CT-1701

D2. Power Connectors



CT-1014

D3. Grounding Connectors



CT-1015

E1. Labeling Systems

E2. Labels

E3. Pre-Printed & Write-On Markers

E4. Permanent Identification

E5. Lockout/Tagout & Safety Solutions

F. Index

Part Number	Part Description	Std. Pkg. Qty.
CT-1525	Crimps <i>PANDUIT</i> #26 – 22 AWG insulated terminals and splices, #22 – 10 AWG fully insulated disconnects and insulated parallel splices. Crimps <i>PANDUIT</i> #22 – 14 AWG barrel insulated disconnects.	1
CT-1550	Crimps most <i>PAN-TERM</i> ® #22 – 10 AWG nylon and vinyl insulated terminals, splices, and disconnects. The CT-1550 has the red/blue pocket closest to the pivot which provides a reduced crimp effort for those who make red/blue terminations.	1
CT-1551	Crimps most <i>PAN-TERM</i> ® #22 – 10 AWG nylon and vinyl insulated terminals, splices, and disconnects. The CT-1551 has the yellow pocket closest to the pivot which provides a reduced crimp effort for those who make yellow terminations.	1
CT-1570	Crimps most <i>PAN-TERM</i> ® #22 – 10 AWG and .5mm ² – 6.0mm ² non-insulated terminals and disconnects. Crimps <i>PANDUIT</i> #22 – 10 AWG and .5mm ² – 6.0mm ² non-insulated splices and #10 AWG compression lugs.	1
CT-1700	Crimps <i>PANDUIT</i> #8 – 2 AWG non-insulated tubular terminals (S series), #8 – 1 AWG copper code conductor lugs and splices, #6 – 4 AWG dual rated aluminum lugs and splices and CTAPF10-16 to CTAPF3-12 copper taps. Includes 5-position, color-coded rotating die.	1
CT-1701	Crimps <i>PANDUIT</i> #10 – 2 AWG non-insulated large gauge ring terminals (P series) and #12 – 4 AWG non-insulated heavy duty ring terminals (P series). Includes 5-position rotating die.	1
CT-1014	Crimps <i>PANDUIT</i> #22 – 14 AWG loose piece <i>DISCO-LOK</i> ™ Disconnects.	1
CT-1015	Crimps <i>PANDUIT</i> #22 – 14 AWG loose piece <i>SUPRA-GRIP</i> ™ Disconnects.	1

For battery powered crimping tools, see compression connector tools selection guide on pages D3.30 – D3.32.

Controlled Cycle Crimping Tools

- Specialty crimping tools for fully insulated right angle disconnects and heat shrink insulated terminals, disconnects, and splices
- Controlled cycle mechanism assures high quality, consistent terminations



Part Number	Part Description	Std. Pkg. Qty.
CT-300-1	Crimps <i>PANDUIT</i> #22 – 14 AWG fully insulated right angle disconnects (DNFR-FIB series).	1
CT-310	Crimps <i>PANDUIT</i> #22 – 10 AWG heat shrink insulated terminals, disconnects, and splices	1

Controlled Cycle Crimping Tools – Ferrule End Sleeve

- Specifically designed for the installation of *PAN-TERM*® Ferrules
- Ergonomic tool design assures operator comfort, safety, and performance
- Controlled cycle mechanism assures high quality, consistent terminations
- Multi-position locator facilitates a high quality repeatable crimp



Part Number	Part Description	Std. Pkg. Qty.
CT-1002	Crimps <i>PANDUIT</i> #26 – 10 AWG single polypropylene insulated ferrules (DIN). #26 – 10 AWG single wire insulated ferrules (French). #22 – 12 AWG polypropylene insulated dual-wire ferrules (DIN). #24 – 10 AWG non-insulated ferrules.	1
CT-1003	Crimps <i>PANDUIT</i> #22 – 8 AWG single wire insulated ferrules (DIN). #22 – 8 AWG single wire polypropylene insulated ferrules (French). #22 – 10 AWG polypropylene insulated dual-wire (DIN) ferrules. #22 – 10 AWG non-insulated ferrules.	1
CT-1004	Crimps <i>PANDUIT</i> #8 – 6 AWG single wire polypropylene insulated ferrule (DIN). #8 – 6 AWG single wire polypropylene insulated ferrules (French). #10 AWG polypropylene insulated dual-wire (DIN) ferrule. #8 – 6 AWG non-insulated ferrules.	1
CT-1005	Crimps <i>PANDUIT</i> #4 – 2 AWG single wire polypropylene insulated ferrule (DIN). #4 – 2 AWG single wire polypropylene insulated ferrules (French). #4 – 2 AWG non-insulated ferrules.	1
CT-1006	Crimps <i>PANDUIT</i> #1 AWG single wire polypropylene insulated ferrule (DIN) and (French). #1 AWG non-insulated ferrules.	1
CT-1104	Controlled cycle square crimp profile tool for #8 – 6 AWG (10mm ² – 16mm ²) insulated and non-insulated ferrules.	1
CT-1123	Controlled cycle square crimp profile tool for #26 – 8 AWG (.14mm ² – 10mm ²) insulated and non-insulated ferrules.	1

A. System Overview

B1. Cable Ties

B2. Cable Accessories

B3. Stainless Steel Ties

C1. Wiring Duct

C2. Surface Raceway

C3. Abrasion Protection

C4. Cable Management

D1. Terminals

D2. Power Connectors

D3. Grounding Connectors

E1. Labeling Systems

E2. Labels

E3. Pre-Printed & Write-On Markers

E4. Permanent Identification

E5. Lockout/Tagout & Safety Solutions

F. Index

A. System Overview



Semiautomatic Ferrule Crimping Tool CT-1000

B1. Cable Ties

- Innovative rapid load design utilizes continuously molded ferrules to significantly reduce installation time
- Adjustable die setting allows termination of all *PANDUIT* #14 – 20 AWG continuously molded ferrules with a single tool
- Controlled cycle tool cuts, strips, and crimps wire to maximize efficiency

B2. Cable Accessories

B3. Stainless Steel Ties



Part Number	Part Description	Std. Pkg. Qty.
CT-1000	Crimps <i>PANDUIT</i> #20 – 14 AWG continuously molded ferrules on strips. Also cuts and strips wire.	1

C1. Wiring Duct

C2. Surface Raceway

Controlled Cycle Crimping Tools – In-Line

- Military specialty tools help meet military and nuclear test requirements for Class 2 applications
- Calibration-recalibration is possible for maintaining exact crimp dimensions
- In-line crimp action for greater dielectric strength with uniform insulation compression

C3. Abrasion Protection

C4. Cable Management



Part Number	Part Description	Std. Pkg. Qty.
CT-400	Crimps #22 – 14 <i>PANDUIT</i> insulated terminals, disconnects, and splices. Comes complete with tools for calibration. Has adjustable pre-load and emergency ratchet. Helps meet military and nuclear requirements.	1
CT-460	Crimps #16 – 10 <i>PANDUIT</i> insulated terminals, disconnects, and splices. Has same features as CT-400 above.	1

For proper crimp head selection, see the tooling selection guide for *PANDUIT* terminals, splices, and disconnects on pages D1.89 – D1.91, in this catalog.

D1. Terminals

D2. Power Connectors

Pneumatic Crimping Tool

- Quickly crimps a variety of loose piece terminals in a variety of wire sizes for medium volume production
- Portable — the small size, ease of bench mounting and quick pneumatic connection allow the tool to be moved from one work station to another or to the work itself
- Versatile interchangeable crimping heads let you switch terminal types quickly to meet changing production requirements; this tool, when used with only four crimp heads, can crimp a full range of #26 – 10 AWG insulated and non-insulated terminal products

D3. Grounding Connectors

E1. Labeling Systems



E2. Labels

E3. Pre-Printed & Write-On Markers

E4. Permanent Identification

E5. Lockout/Tagout & Safety Solutions

F. Index

Part Number	Part Description	Std. Pkg. Qty.
CT-600-A	Pneumatic tool, 6' air hose and carrying case. Does not include crimping heads (ordered separately).	1
CT-500CH	Crimping head for most #22 – 14 insulated terminals, splices, and disconnects.	1
CT-520CH	Crimping head for most #22 – 14 insulated butted seam disconnects and #26 – 22 insulated terminals.	1
CT-550CH	Crimping head for most #22 – 10 insulated terminals and splices.	1
CT-570CH	Crimping head for #22 – 10 non-insulated terminals, splices, and disconnects.	1
PD-600-A	Positioning device (for bench mounting of CT-600-A).	1
FPC-600-A	Foot actuator operating air pressure: 80 – 100 psi .233 SCFM type of air: lubricated. Recommend using Norgren (Brand) #FLR222-012-043008 filter lubricator regulator.	1
K600-A	Update kit for foot pedal control and positioning device to work with new CT-600-A pneumatic crimping tool.	1

For proper crimp head selection, see the tooling selection guide for *PANDUIT* terminals, splices, and disconnects on pages D1.89 – D1.91, in this catalog.

Die Type, Manual, Crimping Tool

- High quality, durable tool construction provides long term dependability
- Develops 6 tons of crimping force, crimps copper compression lugs and splices up to 500 kcmil
- Provides UL Listed and CSA Certified connections on *PANDUIT* copper and aluminum lugs, splices insulated terminals



Part Number	Part Description	Std. Pkg. Qty.
CT-720	Manual crimping tool for UL Listed or Recognized and CSA Certified terminations of <i>PANDUIT</i> ® <i>PAN-LUG</i> ™ copper compression lugs and splices for #8 AWG – 500 kcmil copper code conductor and aluminum compression lugs and splices for #6 AWG – 350 kcmil copper and aluminum code conductors. Provides UL Listed terminations of <i>PANDUIT</i> ® <i>PAN-TERM</i> ® #8 – 2 AWG vinyl insulated terminals. Color-coded CD-720 crimping dies, carrying/storage case, and controlled cycle mechanism must be purchased separately. Specifications: Output: 6 tons Weight: 7.7 lbs. Length: 26" Handle span: 58" (open), 2.5" (closed) Warranty: 90 days	1
CC-720	Optional controlled cycle mechanism only. Total weight of tool with CC-720 is 8.25 lbs.	1
C-720	Black steel carrying case for CT-720 crimping tool.	1

For battery powered crimping tools, see compression connector tools selection guide on pages D3.30 – D3.32.

CD-720 Crimping Dies

- Color-coded for easy matching to color-coding marked on connectors
- Embosses die index number on connector barrels to provide post crimp inspection except CD-720PV8-2
- Part number permanently marked on crimping die for easy identification
- Provides 5-sided crimp results in terminations with premium electrical and mechanical performance



CD-720PV8-2

Part Number	Used to Install <i>PANDUIT</i> Compression Lug and Splice Sizes				Std. Pkg. Qty.
	Copper Conductor Size	Copper Die Color and Die No.	Aluminum Conductor Size	Aluminum Die Color and Die No.	
CD-720-1	#8 – 2 AWG	Red P21 Blue P24 Gray P29 Brown P33	#6 AWG	Gray P29	1
CD-720-2	#1 – 3/0 AWG	Green P37 Pink P42 Black P45 Orange P50	#4 – 1/0 AWG	Green P37 Pink P42 Gold P45 Tan P50	1
CD-720-3	4/0 AWG – 250 kcmil	Purple P54 Yellow P62	2/0 – 3/0 AWG	Olive P54 Ruby P62	1
CD-720-4	300 kcmil	White P66	4/0 AWG	White P66	1
CD-720-5	350 kcmil	Red P71	250 kcmil	Red P71	1
CD-720-6	400 kcmil	Blue P76	300 kcmil	Blue P76	1
CD-720-7	500 kcmil	Brown P87	350 kcmil	Brown P87	1
CD-720PV8-2	#8 – 2 AWG, Vinyl Insulated <i>PAN-TERM</i> ® Terminals	Red, Blue, Yellow	—	—	1

See pages D3.30 – D3.32 for connector and tool selection information.

A.
System
Overview



CT-2500 Battery Powered Crimping Tool

B1.
Cable Ties

- Quick two-second crimping cycle results in less time to crimp terminals compared to conventional methods
- Interchangeable crimp heads for termination of all *PANDUIT* #22 – 10 AWG terminals, disconnects, and splices
- Lightweight 3.3 lb. design provides maximum productivity and ease of use in continuous workflow operations

B2.
Cable
Accessories

B3.
Stainless
Steel Ties



CT-2500CHR

C1.
Wiring
Duct

C2.
Surface
Raceway



CT-2500BC

C3.
Abrasion
Protection

C4.
Cable
Management



CT-2500CASE

D1.
Terminals

D2.
Power
Connectors

D3.
Grounding
Connectors



CT-2550CH

E1.
Labeling
Systems

E2.
Labels

E3.
Pre-Printed
& Write-On
Markers

E4.
Permanent
Identification

E5.
Lockout/
Tagout/
& Safety
Solutions

F.
Index

Part Number	Part Description	Std. Pkg. Qty.
Crimping Tools		
CT-2500	Crimps <i>PANDUIT</i> #22 – 10 AWG insulated and non-insulated terminals, disconnects and splices. Includes tool, two batteries, a battery charger and carrying case. Crimp heads not included. Meets U.S. voltage requirements.	1
CT-2500/E	Crimps <i>PANDUIT</i> #22 – 10 AWG insulated and non-insulated terminals, disconnects, and splices. Includes tool, two batteries, a battery charger and carrying case. Crimp heads not included. Meets European voltage requirements.	1
Accessories		
CT-2500CHR	U.S. compatible battery charger for use with the CT-2500.	1
CT-2500CHR/E	European compatible battery charger for use with the CT-2500/E.	1
CT-2500BC	Rechargeable tool battery for use with the CT-2500.	1
CT-2500CASE	Carrying case holds CT-2500 and accessories.	1
Crimp Heads		
CT-2550CH	Crimps <i>PANDUIT</i> #22 – 10 AWG insulated terminals, disconnects, and splices.	1
CT-2525CH	Crimps <i>PANDUIT</i> #22 – 10 AWG fully insulated disconnects and insulated parallel splices.	1
CT-2570CH	Crimps <i>PANDUIT</i> #22 – 10 AWG non-insulated terminals, disconnects, and splices.	1

A.
System
Overview

B1.
Cable Ties

B2.
Cable
Accessories

B3.
Stainless
Steel Ties

C1.
Wiring
Duct

C2.
Surface
Raceway

C3.
Abrasion
Protection

C4.
Cable
Management

D1.
Terminals

D2.
Power
Connectors

D3.
Grounding
Connectors

E1.
Labeling
Systems

E2.
Labels

E3.
Pre-Printed
& Write-On
Markers

E4.
Permanent
Identification

E5.
Lockout/
Tagout
& Safety
Solutions

F.
Index

Tooling Selection Guide for PANDUIT Terminals, Splices, and Disconnects (continued)

PANDUIT Terminal Series	Terminal Description	Std. Wire Range (AWG)	Wire Strip Length (In.) [+1/32;-0]	Plier Tools				Controlled Cycle Hand Tools										Crimp Heads for Pneumatic CT-600-A Tool				Mechanical			
				CT-100	CT-160	CT-200	CT-260	CT-300-1	CT-310	CT-400	CT-460	CT-1014	CT-1015	CT-1525	CT-1550	CT-1551	CT-1570	CT-1701	CT-2500	CT-500CH	CT-520CH	CT-550CH	CT-570CH	CT-720	
DNF-M	Nylon insulated, funnel entry, barrel insulated, male disconnects	22 - 18	9/32	X	X		X											X	X						
		16 - 14	9/32	X	X		X											X	X						
		12 - 10	9/32	X	X		X											X							
DNFR-B	Nylon pre-insulated, right angle disconnects	22 - 18	9/32	X								X													
		16 - 14	9/32	X								X													
DNFR-FIB	Nylon butted seam, right angle disconnects	22 - 18	11/32					X																	
		16 - 14	11/32					X																	
DNG-FB	SUPRA GRIP™ nylon, fully insulated disc., (except DNG14-187FB and DNG14-188FB)	22 - 18	1/4										X												
		16 - 14	1/4										X												
DNG-FL	DISCO-LOK™ nylon, fully insulated disconnects	22 - 18	1/4											X											
		16 - 14	1/4											X											
DNH	Heat shrink disconnects	22 - 18	5/16							X															
		16 - 14	5/16							X															
		12 - 10	5/16							X															
DV	Vinyl barrel insulated sleeved disconnects	22 - 18	9/32	X														X	X					X	
		16 - 14	9/32	X															X	X				X	
DV-B	Vinyl insulated, butted seam disconnects	22 - 18	1/4	X										X					X					X	
		16 - 14	1/4	X										X					X					X	
DV-M	Vinyl barrel insulated male blade adapters	22 - 18	9/32	X	X		X				X				X	X			X	X				X	
		16 - 14	9/32	X	X		X				X	X			X	X			X	X				X	
DV-MB	Vinyl insulated butted seam male disconnects	22 - 18	9/32	X			X												X	X				X	
		16 - 14	9/32	X			X				X	X							X	X				X	
DV-P	Vinyl insulated piggyback disconnects	22 - 18	1/4	X	X		X								X	X			X	X				X	
		16 - 14	1/4	X	X		X									X	X			X	X			X	
DVF	Vinyl funnel entry barrel insulated female disconnect	22 - 18	9/32																X	X				X	
		16 - 14	9/32																X	X				X	
J	Non-insulated wire joints																								
		J214-312	14 - 12	1/2	X		X																		
		J318-412	18 - 12	1/2	X		X																		
		J216-410	16 - 10	3/4			X																		
JN	Nylon insulated wire joints																								
		JN224-318	24 - 16	7/16	X	X		X							X	X			X	X				X	
		JN218-216	22 - 16	7/16	X	X					X				X	X			X	X				X	
		JN418-212	18 - 12	1/2	X	X						X			X	X			X	X				X	
		JN314-412	14 - 12	5/8		X																			
P-HDR	Non-insulated heavy duty rings	16 - 12	9/32	X		X	X										X	X	X				X		
P-P	Non-insulated pin terminals	22 - 18	9/32	X	X	X	X											X						X	
		16 - 14	9/32	X	X	X	X											X						X	
		12 - 10	9/32	X	X	X	X											X	X	X				X	
P-R	Non-insulated large ring terminals	8	3/8																X						
		6	7/16																X						
		4	1/2																X						
		2	1/2																X						

Tooling Selection Guide for PANDUIT Terminals, Splices, and Disconnects (continued)

PANDUIT Terminal Series	Terminal Description	Std. Wire Range (AWG)	Wire Strip Length (In.) [+1/32;-0]	Plier Tools				Controlled Cycle Hand Tools												Crimp Heads for Pneumatic CT-600-A Tool				Mechanical			
				CT-100	CT-160	CT-200	CT-260	CT-300-1	CT-310	CT-400	CT-460	CT-1014	CT-1015	CT-1525	CT-1550	CT-1551	CT-1570	CT-1701	CT-2500	CT-500CH	CT-520CH	CT-550CH	CT-570CH	CT-720			
P-R, P-F, P-LF, P-SLF, P-FF	Non-insulated rings, forks, locking forks, short locking forks, flanged forks	26 – 22	3/16	X		X	X																				
		22 – 18	7/32	X	X	X	X																				
		16 – 14	7/32	X	X	X	X																				
		12 – 10	9/32	X	X	X	X																				
P-RHT6	High temperature rings	22 – 18	9/32	X	X	X	X																				
		16 – 14	9/32	X	X	X	X																				
		12 – 10	9/32	X	X	X	X																				
PH	Heat shrink terminals	22 – 18	5/16						X																		
		16 – 14	5/16						X																		
		12 – 10	5/16						X																		
PN-R, PN-RX, PN-F, PN-LF, PN-FF, PNF-R, PNF-F, PNF-LF	Nylon and nylon funnel entry forks, locking forks, flanged forks (includes expanded insulation)	26 – 22	3/16	X																							
		22 – 18	7/32	X							X																
		16 – 14	7/32	X							X	X															
		12 – 10	9/32	X								X															
PN-HDR, PN-HDRX	Nylon insulated heavy duty and nylon expanded insulated heavy duty rings	16 – 12	9/32								X																
PN-SLF, PNF-SLF	Nylon insulated short locking forks	22 – 18	7/32								X																
		16 – 14	7/32								X	X															
		12 – 10	9/32									X															
PS	Non-insulated parallel splices	22 – 18	5/16	X		X	X																				
		20 – 16	5/16	X		X	X																				
		14 – 12	7/16	X		X	X																				
PSN	Nylon insulated parallel splices	22 – 18	5/16																								
		20 – 16	5/16	X	X		X																				
		14 – 12	7/16																								
PK-R	KYNAR® rings	22 – 18	7/32	X			X				X																
		16 – 14	7/32	X			X					X															
		12 – 10	9/32	X																							
PV-HDR, PV-HDRX	Vinyl insulated heavy duty rings	16 – 12	5/16								X																
PV-LF, PV-LFX	Vinyl insulated locking forks (includes expanded insulation)	22 – 18	5/16	X			X				X																
		16 – 14	5/16	X							X	X															
		12 – 10	5/16	X		X						X															
PV-P	Vinyl insulated pin terminals	22 – 18	5/16	X	X		X																				
		16 – 14	5/16	X	X		X																				
		12 – 10	5/16	X	X		X																				
PV-R, PV-F, PV-FF, PV-RX, PV-FX	Vinyl insulated rings and forks (includes expanded insulation)	26 – 22	3/16	X																							
		22 – 18	5/16	X	X		X																				
		16 – 14	5/16	X	X		X																				
		12 – 10	5/16	X	X		X																				
PV-R, PV-RX	Vinyl insulated large ring terminals	8	3/8																							X‡	
		6	7/16																							X‡	
		4	1/2																								X‡
		2	1/2																								X‡
PV-SLF	Vinyl insulated short locking forks	22 – 18	5/16								X																
		16 – 14	5/16								X	X															
		12 – 10	5/16																								

*KYNAR is a registered trademark of Atonfina Chemicals, Inc.
 ‡Use Die CD-720PV8-2.

A. System Overview

B1. Cable Ties

B2. Cable Accessories

B3. Stainless Steel Ties

C1. Wiring Duct

C2. Surface Raceway

C3. Abrasion Protection

C4. Cable Management

D1. Terminals

D2. Power Connectors

D3. Grounding Connectors

E1. Labeling Systems

E2. Labels

E3. Pre-Printed & Write-On Markers

E4. Permanent Identification

E5. Lockout/Tagout & Safety Solutions

F. Index

A.
System
Overview

Tooling Selection Guide for *PANDUIT* Tubular Ring Terminals

B1.
Cable Ties

B2.
Cable
Accessories

B3.
Stainless
Steel Ties

C1.
Wiring
Duct

C2.
Surface
Raceway

C3.
Abrasion
Protection

C4.
Cable
Management

D1.
Terminals

D2.
Power
Connectors

D3.
Grounding
Connectors

E1.
Labeling
Systems

E2.
Labels

E3.
Pre-Printed
& Write-On
Markers

E4.
Permanent
Identification

E5.
Lockout/
Tagout/
& Safety
Solutions

F.
Index

Tooling	CT-1700	CT-720	CT-930, CT-930CH, CT-920, CT-920CH, CT-2920, CT-940CH	CT-980, CT-980CH, CT-2950, CT-2980	CT-2001
<i>PANDUIT</i> Part Number	<i>PANDUIT</i> Die Part Number Die Index Number (Number of Crimps)				
S8-10R-Q	P21 (2)	CD-720-1 P21 (1)	CD-920-8 P21 (1)	—	CD-2001-8 P21 (1)
S8-14R-Q					
S8-56R-Q					
S8-38R-Q					
S6-10R-E	P24 (2)	CD-720-1 P24 (1)	CD-920-6 P24 (1)	—	CD-2001-6 P24 (1)
S6-14R-E					
S6-56R-E					
S6-38R-E					
S4-10R-E	P29 (2)	CD-720-1 P29 (1)	CD-920-4 P28 (1)	STD (1)	CD-2001-4 P29 (1)
S4-14R-E					
S4-56R-E					
S4-38R-E					
S2-10R-X	P37 (3)	CD-720-2 P37 (1)	CD-920-1 P37 (1)	STD (1)	CD-2001-1 P37 (1)
S2-14R-X					
S2-56R-X					
S2-38R-X					
S2-12R-X	—	CD-720-2 P42 (1)	CD-920-1/0 P42 (1)	STD (1)	CD-2001-1/0 P42 (1)
S1/0-14R-X					
S1/0-56R-X					
S1/0-38R-X					
S1/0-12R-X	—	CD-720-2 P45 (2)	CD-920-2/0 P45 (1)	STD (1)	CD-2001-2/0 P45 (2)
S2/0-14R-X					
S2/0-56R-X					
S2/0-38R-X					
S2/0-76R-X	—	CD-720-2 P50 (2)	CD-920-3/0 P50 (1)	STD (1)	CD-2001-3/0 P50 (2)
S2/0-12R-X					
S3/0-14R-5					
S3/0-56R-5					
S3/0-38R-5	—	CD-720-2 P54 (2)	CD-920-4/0 P54 (1)	STD (1)	CD-2001-4/0 P54 (2)
S3/0-76R-5					
S3/0-12R-5					
S4/0-38R-5					
S4/0-76R-5	—	CD-720-3 P62 (2)	CD-920-250 P62 (1)	STD (1)	CD-2001-250 P62 (2)
S4/012R-5					
S250-56R-5					
S250-38R-5					
S250-76R-5	—	CD-720-3 P62 (2)	CD-920-250 P62 (1)	STD (1)	CD-2001-250 P62 (2)
S250-12R-5					

Tooling Selection Guide for PANDUIT Ferrules

PANDUIT Ferrule Series	Ferrule Description	Wire Range (AWG)	Wire Range (mm ²)	Wire Strip Length	Controlled Cycle Hand Tools									
					CT-1000	CT-1002	CT-1003	CT-1004	CT-1005	CT-1006	CT-1104	CT-1123		
F	Non-insulated ferrules	24	.25	Please See Ferrule Tables – Pgs. D1.73 – D1.77		X	X							
		22 – 18	.50 – 1.00			X	X						X	
		16	1.50			X	X						X	
		14	2.50			X	X							
		12	4.00			X	X						X	
		10	6.00			X	X						X	
		8	10.0				X	X					X	
		6	16.0					X	X				X	
		4 – 2	25.0 – 35.0								X		X	
		1	50.0									X		
FSD, FSF	Insulated single wire ferrules (DIN or French color code)	26 – 18	.41 – 1.00			X	X					X		
		16 – 14	1.50 – 2.00			X	X					X		
		12 – 10	4.00 – 6.00			X	X					X		
		8	10.0				X	X			X	X		
		6	16.0				X	X			X			
		4 – 2	25.0 – 35.0							X				
FTD	Insulated twin wire ferrules	22 – 18	.50 – 1.00			X	X					X		
		16 – 14	1.50 – 2.00			X	X					X		
		12	4.00				X	X				X		
		10	6.00				X	X			X			
FSD-DSL FS-DSL	Insulated single wire ferrules on strips of 50 (DIN or other color code)	20 – 14	.50 – 2.50	.31" (8mm)	X									

A. System Overview

B1. Cable Ties

B2. Cable Accessories

B3. Stainless Steel Ties

C1. Wiring Duct

C2. Surface Raceway

C3. Abrasion Protection

C4. Cable Management

D1. Terminals

D2. Power Connectors

D3. Grounding Connectors

E1. Labeling Systems

E2. Labels

E3. Pre-Printed & Write-On Markers

E4. Permanent Identification

E5. Lockout/Tagout & Safety Solutions

F. Index

A.
System
Overview

Technical Specification and Selection Information

B1.
Cable Ties

The following pages provide information helpful in specifying *PANDUIT* terminals and selecting the appropriate terminal and tooling for your applications.

B2.
Cable
Accessories

PANDUIT Terminal Approvals



B3.
Stainless
Steel Ties

C1.
Wiring
Duct

C2.
Surface
Raceway

C3.
Abrasion
Protection

C4.
Cable
Management

D1.
Terminals

D2.
Power
Connectors

D3.
Grounding
Connectors

E1.
Labeling
Systems

E2.
Labels

E3.
Pre-Printed
& Write-On
Markers

E4.
Permanent
Identification

E5.
Lockout/
Tagout
& Safety
Solutions

F.
Index

Logo (Symbol)	Agency	Spec/Approval	Requirement	Applicable Products
	Underwriters Laboratories, Inc.	#E52164 – UL 486A	Minimum tensile strength (pull out force for the crimp terminal) and test current for max. 50°C rise (amps)	All Ring and Fork Terminals
		#E78522 – UL 310	Minimum tensile strength (pull out force for the crimp terminal) and continuous test current for max. 30°C rise (amps) (for .187", .205", .250" tab widths) and (.110" tab width)	All Disconnects
		#E52164 – UL 486C	Minimum tensile strength (pull out force for the crimp terminal) and test current for max. 50°C rise (amps)	All Splices
	Canadian Standards Association	#LR31212 – C22.2 No. 65	Minimum tensile Strength (pull out force for the crimp terminal) and test current for max. 50°C rise (amps)	All Ring and Fork Terminals
		#LR31212 – C22.2 No. 153		All Disconnects
	American Bureau of Shipping	ABS Rules, Steel Vessel Rules 1-1-4/7.7, 4-8-3/9.19, 4-8-4/21.28	Passed extensive testing requirements to verify that product will perform reliably in marine and offshore environments	Fork Terminals: P-F, PN-F, PV-F, PN-LF, PNF-LF, PV-LF, P-LF Ring Terminals: P-R, PN-R, PNF-R, RV-R, S-R Wire Joints: JN224-318, JN218-216, JN418-212 Splices: BSN, BSV, BS Disconnects: DNF, DNF-FIB, DVF, D, DNF-FL, DNF-M, DNF18-250M, DNF14-250M, DNF18-250FIM, FIMB, FIB, 14-250FIM, FIMB, FIB
	U.S. Code, Title 10, Section 2533a	The Berry Amendment 252.225-7014 for Specialty Metals	Bans the use of various metals manufactured outside of the United States	All Ring, Fork, Pin and Blade Terminals, Splices, Ferrules, Wire Joints and Disconnects
	IEEE (Institute of Electrical and Electronics Engineers)	IEEE std 323-2003 for Qualifying Class 1E Eqpt. for Nuclear Power Generating Stations	Meets criteria for use in harsh, high radiation environments in nuclear power plants	■KYNAR Ring Terminals
	Dept. of Defense	Mil Spec Qualification Test Ref #01017302.AB/08-31-2006	Approved for listing on QPL AS 7928 Class I and Class II	Ring Terminals

■KYNAR is a registered trademark of Atofina Chemicals, Inc.

Performance Requirements

	Wire Size (AWG)								
	#26	#24	#22	#20	#18	#16	#14	#12	#10
UL 486A (TERMINALS), UL 310 (MALE BLADE ADAPTERS)									
Test Current for Max. 50°C Rise (Amps)	3.5	7	9	12	17	18	30	35	50
Min. Tensile Strength* (Lbs.)	3	5	8	13	20	30	50	70	80
UL 486C (SPLICES)									
Test Current for Max. 50°C Rise (Amps)	5.5	7	9	12	17	18	30	35	50
Min. Tensile Strength* (Lbs.)	3	5	8	10	10	15	25	35	40

*Pull-out force of the crimped terminal.

	Wire Size (AWG)						
	#22	#20	#18	#16	*#14	#12	#10
UL 310 (DISCONNECTS)							
Continuous Test Current for Max. 30°C Rise (amps) (for 187", 205", 250" tab widths)	3	4	7	10	15	20	24
Continuous Test Current for Max. 30°C Rise (amps) (for .110", tab width)	2	3	4	5	Not Applicable		
Min. Tensile Strength* (Lbs.)	8	13	20	30	50	70	80

*Pull-out force of the crimped disconnect.

Applicable **PAN-TERM®** products meet or exceed the following test specifications:

- UL 486A (Terminals)
- UL 486C (Splices)
- UL 310 (Blade Adapters)
- CSA C22.2 No. 65 (all designs)

UL and CSA approved products are shown with the applicable logos in the product section. UL file #E52164, CSA File #LR31212.

Applicable **PAN-TERM®** products meet or exceed the following test specifications:

- UL 310 (Disconnects)
- CSA C22.2 No. 153 (all designs)

UL and CSA Listed products are shown with the applicable logos in the product section. UL file #E78522 and CSA file #LR31212.

PANDUIT® PAN-TERM® Terminal Military Cross Reference

Current Mil. Std Part No., Class 1	Ring Terminals Nylon Insulated
MS25036-101	PN18-6RN
MS25036-102	PN18-6R
MS25036-103	PN18-10R
MS25036-104	PN18-56R
MS25036-105	PN18-38R
MS25036-106	PN14-6RN
MS25036-107	PN14-6R
MS25036-108	PN14-10R
MS25036-109	PN14-56R
MS25036-110	PN14-38R
MS25036-111	PN10-6R
MS25036-112	PN10-10R
MS25036-113	PN10-56R
MS25036-114	PN10-38R
MS25036-148	PN18-4RN
MS25036-149	PN18-8R
MS25036-150	PN18-14R
MS25036-152	PN14-4R
MS25036-153	PN14-8R
MS25036-154	PN14-14R
MS25036-156	PN10-8R
MS25036-157	PN10-14R

Current Mil. Std. Part No., Class 2	Ring Terminals, Nylon Insulated or Nylon Insulated with Funnel Entry
MS25036-101	PN18-6RN or PNF18-6RN
MS25036-102	PN18-6R or PNF18-6R
MS25036-103	PN18-10R or PNF18-10R
MS25036-104	PN18-56R or PNF18-56R
MS25036-105	PN18-38R or PNF18-38R
MS25036-106	PN14-6RN or PNF14-6RN
MS25036-107	PN14-6R or PNF14-6R
MS25036-108	PN14-10R or PNF14-10R
MS25036-109	PN14-56R or PNF14-56R
MS25036-110	PN14-38R or PNF14-38R
MS25036-111	PN10-6R or PNF10-6R
MS25036-112	PN10-10R or PNF10-10R
MS25036-113	PN10-56R or PNF10-56R
MS25036-114	PN10-38R or PNF10-38R
MS25036-148	PN18-4RN or PNF18-4RN
MS25036-149	PN18-8R or PNF18-8R
MS25036-150	PN18-14R or PNF18-14R
MS25036-152	PN14-4R or PNF14-4R
MS25036-153	PN14-8R or PNF14-8R
MS25036-154	PN14-14R or PNF14-14R
MS25036-156	PN10-8R or PNF10-8R
MS25036-157	PN10-14R or PNF10-14R

Crimping Tools: CT-400 and CT-460

Current Mil. Std. Part No., Class 1	Ring Terminals Non-Insulated
MS20659-165	P10-6R
MS20659-105	P10-10R
MS20659-106	P10-56R
MS20659-128	P10-38R

A. System Overview

B1. Cable Ties

B2. Cable Accessories

B3. Stainless Steel Ties

C1. Wiring Duct

C2. Surface Raceway

C3. Abrasion Protection

C4. Cable Management

D1. Terminals

D2. Power Connectors

D3. Grounding Connectors

E1. Labeling Systems

E2. Labels

E3. Pre-Printed & Write-On Markers

E4. Permanent Identification

E5. Lockout/Tagout & Safety Solutions

F. Index

A.
System
Overview

Stud Size Chart (Inches/Millimeters)

B1.
Cable Ties

B2.
Cable
Accessories

B3.
Stainless
Steel Ties

C1.
Wiring
Duct

C2.
Surface
Raceway

C3.
Abrasion
Protection

C4.
Cable
Management

D1.
Terminals

D2.
Power
Connectors

D3.
Grounding
Connectors

E1.
Labeling
Systems











E2.
Labels

E3.
Pre-Printed
& Write-On
Markers

E4.
Permanent
Identification



E5.
Lockout/
Tagout/
& Safety
Solutions

F.
Index

										
Standard Stud Size	#2	#4	#5	#6	#8	#10	1/4"	5/16"	3/8"	7/16"
Metric Stud Size (mm)	M2	M2.5	M3	M.35	M4	M5	M6	M8	M10	M11
Stud Size Decimal Equivalent	.086"	.112"	.127"	.138"	.164"	.190"	.250"	.312"	.375"	.438"
Metric Diameter (mm)	2.18	2.84	3.18	3.51	4.17	4.83	6.35	7.92	9.53	11.13
Terminal Hole Diameter	.090"	.118"	.130"	.147"	.173"	.204"	.270"	.343"	.392**	.456"
Terminal Hole Diameter Metric (mm)	2.29	3.0	3.23	3.71	4.39	5.18	6.86	8.71	9.78	11.58
Stud Size Designation in PANDUIT Part Number	2	4	5	6	8	10	14	56	38	76

*Terminal stud.

**Power Connector stud.

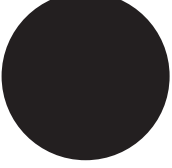
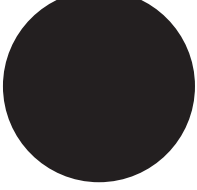
					
Standard Stud Size	1/2"	5/8"	3/4"	7/8"	1"
Metric Stud Size (mm)	M12	M16	M18	M20	M25
Stud Size Decimal Equivalent	.500"	.625"	.750"	.875"	1.00"
Metric Diameter (mm)	12.7	15.88	19.05	22.23	25.4
Terminal Hole Diameter	.531"	.656"	.810"	.906"	1.031"
Terminal Hole Diameter Metric (mm)	13.49	16.66	20.57	23.01	26.19
Stud Size Designation in PANDUIT Part Number	12	58	34	78	1

Note: Stud hole diagrams are for U.S. reference only.

Equivalent Tables

Decimal/Inches/Millimeters

1/64 — .0156 0,396	17/64 — .2656 6,746	33/64 — .5156 13,100	49/64 — .7656 19,446
1/32 — 0.312 0,792	9/32 — .2812 7,143	17/32 — .5312 13,492	25/32 — .7812 14,842
3/64 — .0468 1,189	19/64 — .2968 7,541	35/64 — .5468 13,891	51/64 — .7968 20,241
1/16 — .0625 1,588	5/16 — .3125 7,938	9/16 — .5625 14,288	13/16 — .8125 20,637
5/64 — .0781 1,984	21/64 — .3281 8,337	37/64 — .5781 14,684	53/64 — .8281 21,034
3/32 — .0937 2,380	11/32 — .3437 8,730	19/32 — .5937 15,080	27/32 — .8437 21,480
7/64 — .1093 2,779	23/64 — .3593 9,129	39/64 — .6093 15,479	55/64 — .8593 21,828
1/8 — .125 3,175	3/8 — .375 9,525	5/8 — .625 15,875	7/8 — .875 22,225
9/64 — .1406 3,571	25/64 — .3906 9,921	41/64 — .6406 16,271	57/64 — .8906 22,620
5/32 — .1562 3,968	13/32 — .4062 10,317	21/32 — .6562 16,667	29/32 — .9062 23,017
11/64 — .1718 4,366	27/64 — .4218 10,716	43/64 — .6718 17,066	59/64 — .9218 23,416
3/16 — .1875 4,763	7/16 — .4375 11,113	11/16 — .6875 17,463	15/16 — .9375 23,810
13/64 — .2031 5,159	29/64 — .4531 11,509	45/64 — .7031 17,859	61/64 — .9531 24,208
7/32 — .2187 5,555	15/32 — .4687 11,905	23/32 — .7187 18,255	31/32 — .9687 24,605
15/64 — .2343 5,954	31/64 — .4843 12,304	47/64 — .7343 18,654	63/64 — .9843 25,001
1/4 — .25 6,350	1/2 — .5 12,700	3/4 — .75 19,050	1 — 1. 25,400

Common Conductor Size Chart (Stranded Wire)

Size	No. of Strands	Individual Strand Size			Conductor Size				
		Inches (mm)	Inches (mm)	Circle Mil Area (mm ²)	Inches (mm)	Inches (mm)	Circle Mil Area (mm ²)		
22 AWG	7	.0096 (0.24)	.029 (0.74)	640 (0.324)	1/0 AWG	19	.0745 (1.89)	.373 (9.47)	105,600 (0.823)
20 AWG	10	.0100 (0.25)	.038 (0.97)	1020 (0.519)	2/0 AWG	19	.0837 (2.13)	.418 (10.62)	133,100 (67.43)
18 AWG	16	.0100 (0.25)	.048 (1.22)	1620 (0.823)	3/0 AWG	19	.0940 (2.39)	.470 (11.94)	167,800 (85.01)
16 AWG	26	.0100 (0.25)	.060 (1.52)	2580 (1.310)	4/0 AWG	19	.1055 (2.68)	.528 (13.41)	211,600 (107.2)
14 AWG	7	.0242 (0.61)	.073 (1.85)	4110 (2.080)	250 kcmil	37	.0822 (2.09)	.575 (14.61)	250,000 (127)
12 AWG	7	.0305 (0.77)	.092 (2.34)	6530 (3.310)	300 kcmil	37	.0900 (2.29)	.630 (16.00)	300,000 (152)
10 AWG	7	.0385 (0.98)	.116 (2.95)	10,380 (5.261)	350 kcmil	37	.0973 (2.47)	.681 (17.29)	350,000 (177)
8 AWG	7	.0486 (1.23)	.146 (3.71)	16,510 (8.367)	400 kcmil	37	.1040 (2.64)	.728 (18.49)	400,000 (203)
6 AWG	7	.0612 (1.55)	.184 (4.67)	26,240 (13.30)	500 kcmil	37	.1162 (2.95)	.813 (20.65)	500,000 (253)
4 AWG	7	.0772 (1.96)	.232 (5.89)	41,740 (21.15)	600 kcmil	61	.0992 (2.52)	.893 (22.68)	600,000 (304)
2 AWG	7	.0974 (2.47)	.292 (7.42)	66,360 (33.62)	750 kcmil	61	.1109 (2.82)	.998 (25.35)	750,000 (380)
1 AWG	19	.0664 (1.69)	.332 (8.43)	83,690 (42.41)	800 kcmil	61	.1145 (2.91)	1.031 (26.19)	800,000 (405)
					1000 kcmil	61	.1280 (3.25)	1.152 (29.26)	1,000,000 (507)

A. System Overview

B1. Cable Ties

Common Conductor Sizes and Strandings Reference Chart

B2. Cable Accessories

B3. Stainless Steel Ties

C1. Wiring Duct

C2. Surface Raceway

C3. Abrasion Protection

C4. Cable Management

D1. Terminals

D2. Power Connectors

D3. Grounding Connectors

E1. Labeling Systems

E2. Labels

E3. Pre-Printed & Write-On Markers

E4. Permanent Identification

E5. Lockout/Tagout & Safety Solutions

F. Index

Conductor		Individual Strands			Overall Conductor Size			Conductor		Individual Strands			Overall Conductor Size		
AWG	Metric mm ²	No.	Diameter		Diameter		Circ. MILS	AWG	Metric mm ²	No.	Diameter		Diameter		Circ. MILS
			mm	In.	mm	In.					mm	In.	mm	In.	
	.05	25	.05	.002	.25	.010	97			19	0.25	.010	1.30	.051	1841
	.06	41	.05	.002	.36	.014	159			1	1.13	.044	1.13	.044	1979
26		10	.13	.005	.53	.021	250	16		32	.20	.008	1.30	.051	1984
		1	.41	.016	.41	.016	256			7	.43	.017	1.30	.051	2006
		7	.16	.006	.48	.019	278			19	.29	.011	1.47	.058	2426
		19	.10	.004	.51	.020	304			65	.16	.006	1.50	.059	2580
		41	.08	.003	.58	.023	384			*26	.25	.010	1.50	.059	2600
24		10	.16	.006	.58	.023	397			1	1.30	.051	1.30	.051	2601
		1	.51	.020	.51	.020	400			105	.13	.005	1.50	.059	2625
		7	.20	.008	.61	.024	448			*7	.51	.020	1.52	.060	2828
		19	.13	.005	.61	.024	475			30	.25	.010	1.70	.067	2906
		65	.07	.003	.65	.026	484			21	.30	.012	1.60	.063	2930
22		128	.05	.002	.65	.026	496			189	.10	.004	1.90	.075	2930
		32	.10	.004	.65	.026	496			7	.52	.020	1.60	.063	2934
		14	.16	.006	.65	.026	556			1	1.38	.054	1.38	.054	2952
		1	.64	.025	.64	.025	625			45	.16	.006	1.85	.073	3786
		16	.16	.006	.76	.030	635			19	.38	.014	1.85	.073	3831
20		26	.13	.005	.76	.030	650	14		1	1.63	.064	1.63	.064	4096
		7	.25	.010	.76	.030	700			*41	.25	.010	1.85	.073	4100
		19	.16	.006	.79	.031	754			*7	.64	.025	1.85	.073	4481
		48	.10	.004	.80	.031	744			50	.25	.010	2.20	.087	4844
		194	.05	.002	.80	.031	752			7	.67	.026	2.10	.083	4871
18		100	.07	.003	.80	.031	760			35	.30	.012	2.20	.087	4883
		7	.27	.011	.80	.031	791			315	.10	.004	2.20	.087	4883
		12	.21	.008	.80	.031	820			1	1.78	.070	1.78	.070	4911
		21	.16	.006	.80	.031	833			19	.45	.018	2.36	.093	6088
		7	.30	.012	.90	.035	977			*65	.25	.010	2.41	.095	6500
16		16	.20	.008	.90	.035	992	12		165	.16	.006	2.41	.095	6549
		1	.80	.031	.80	.031	992			1	2.06	.081	2.06	.081	6561
		*10	.25	.010	.89	.035	1000			*7	.81	.032	2.44	.096	7168
		1	.81	.032	.81	.032	1024			56	.30	.012	3.10	.122	7812
		41	.13	.005	.91	.036	1025			1	2.26	.089	2.26	.089	7917
14		26	.16	.006	.91	.036	1032	10		511	.10	.004	3.00	.118	7921
		*7	.32	.013	.97	.038	1111			19	.52	.020	2.70	.106	7963
		19	.20	.008	.94	.037	1216			37	.40	.016	2.92	.115	9354
		7	.37	.015	1.10	.043	1485			49	.36	.014	2.95	.116	9880
		24	.20	.008	1.20	.047	1488			*7	.98	.039	2.95	.116	10376
12		1	1.00	.039	1.00	.039	1550			1	2.59	.102	2.59	.102	10404
		*16	.25	.010	1.19	0.047	1600			*105	.25	.010	2.95	.116	10500
		1	1.02	.040	1.02	.040	1600			84	.30	.012	3.50	.138	11718
		65	.13	.005	1.19	.047	1625			756	.10	.004	3.70	.146	11718
		41	.16	.006	1.19	.047	1627			1	2.76	.109	2.76	.109	11807
10		*7	.40	.016	1.22	.048	1770			7	1.05	.041	3.20	.126	11962
		19	.25	.010	1.24	.049	1900			19	.64	.025	3.30	.130	12063

*Strandings required for UL and CSA certification testing.

This chart details the different conductors commonly used in the industry. For each size, either AWG or metric, various stranding options are listed. Typically the higher stranding is used in applications requiring greater conductor flexibility.

AWG to Metric Wire Crosses	
AWG	Metric (mm ²)
26 – 22	0.1 – 0.5
22 – 18	0.5 – 1.0
16 – 14	1.5 – 2.5
12 – 10	4.0 – 6.0

Common Conductor Sizes and Strandings Reference Chart (continued)

Conductor		Individual Strands			Overall Conductor Size			Conductor		Individual Strands			Overall Conductor Size		
		No.	Diameter		Diameter		Area			No.	Diameter		Diameter		Area
AWG	Metric mm ²			mm	In.	mm	In.	Circ. MILS					mm	In.	Circ. MILS
	6	7	0.107	0.042	3.21	0.126	11840		95	19	2.57	0.101	12.8	0.505	187500
		1	2.77	0.109	2.77	0.109	11840			37	1.83	0.072	12.5	0.504	187500
9		7	1.1	0.0432	3.3	0.13	13000	4/0		19	2.89	0.1055	13.4	0.528	211600
		1	2.91	0.1144	2.91	0.114	13090		120	37	2.06	0.081	14.4	0.567	237.8 kcmil
8		1	3.26	0.1285	3.25	0.128	16510	250 kcmil		37	2.07	0.0822	14.6	0.575	250 kcmil
		7	1.23	0.0486	3.7	0.146	16510	300 kcmil	150	37	2.29	0.09	16	0.63	300 kcmil
	10	7	1.37	0.054	4.12	0.162	19740	350 kcmil		37	2.47	0.0973	17.3	0.681	350 kcmil
		1	3.58	0.141	3.58	0.141	19740		185	37	2.54	0.1	17.8	0.7	365.1 kcmil
7		7	1.38	0.0545	4.15	0.164	20520	400 kcmil		37	2.64	0.104	18.5	0.728	400 kcmil
		1	3.67	0.1443	3.67	0.144	20520		240	37	2.9	0.114	20.3	0.798	473.6 kcmil
6		7	1.55	0.0612	4.66	0.184	26240			61	2.26	0.089	20.3	0.801	473.6 kcmil
		1	4.11	0.162	4.11	0.162	26240	500 kcmil		37	2.95	0.1162	20.7	0.813	500 kcmil
	16	7	1.73	0.008	5.13	0.204	31580			61	2.3	0.0905	20.7	0.814	500 kcmil
5		7	1.75	0.0688	5.24	0.206	33090		300 kcmil	61	2.51	0.099	22.6	0.891	592.1 kcmil
4		7	1.96	0.0772	5.88	0.232	41740	600 kcmil		61	2.52	0.0992	22.7	0.893	600 kcmil
	25	7	2.16	0.085	6.48	0.255	49340	700 kcmil		61	2.72	0.1071	24.5	0.964	700 kcmil
		19	1.32	0.052	6.6	0.26	49340	750 kcmil		61	2.82	0.1109	25.4	0.998	750 kcmil
3		7	2.2	0.0867	6.61	0.26	52620			91	2.31	0.0908	25.4	0.998	750 kcmil
2		7	2.47	0.0974	7.42	0.292	66300		400	61	2.9	0.114	26.1	1.026	798.4 kcmil
	35	7	2.54	0.1	7.62	0.300	69070	800 kcmil		61	2.91	0.1145	26.2	1.031	800 kcmil
		19	1.55	0.001	7.75	0.305	69070			91	2.38	0.0938	26.2	1.032	800 kcmil
1		19	1.5	0.0064	8.43	0.332	83690	1000 kcmil	500	61	3.25	0.128	28.3	1.152	986.8 kcmil
	50	19	1.85	0.073	9.27	0.365	98680			91	2.66	0.1048	29.3	1.153	1000 kcmil
1/0		19	1.59	0.0745	9.46	0.373	10500		625	91	2.97	0.117	32.7	1.287	1233.7 kcmil
2/0		19	2.13	0.0837	10.6	0.419	133100								
	70	19	2.18	0.086	10.9	0.43	138100								
		19	2.59	0.094	11.9	0.47	167800								
3/0		36	1.71	0.0673	12	0.471	167800								

This chart details the different conductors commonly used in the industry. For each size, either AWG or metric, various stranding options are listed. Typically the higher stranding is used in applications requiring greater conductor flexibility.

AWG to Metric Wire Crosses	
AWG	Metric (mm ²)
26 – 22	0.1 – 0.5
22 – 18	0.5 – 1.0
16 – 14	1.5 – 2.5
12 – 10	4.0 – 6.0

A.
System
Overview

B1.
Cable Ties

B2.
Cable
Accessories

B3.
Stainless
Steel Ties

C1.
Wiring
Duct

C2.
Surface
Raceway

C3.
Abrasion
Protection

C4.
Cable
Management

D1.
Terminals

D2.
Power
Connectors

D3.
Grounding
Connectors

E1.
Labeling
Systems

E2.
Labels

E3.
Pre-Printed
& Write-On
Markers

E4.
Permanent
Identification

E5.
Lockout/
Tagout/
& Safety
Solutions

F.
Index

NOTES

REEL SMART™ SYSTEM



The PANDUIT® REEL SMART™ System provides the best solution for quality, high volume terminations designed to dramatically reduce set-up time and production downtime. This increased efficiency translates into real cost savings throughout the termination process from start to finish.



NEW!

- One applicator system terminates over 400 continuously molded terminals, reducing cost of ownership
- Continuously molded integrated carrier guarantees alignment of terminal; front-to-back and side-to-side to eliminate skewing of product resulting in consistent, high quality low cost termination
- Available in large reels requiring less product changeover, resulting in less downtime
- Applicable sizes are UL Listed and CSA Certified, as noted
- PANDUIT® CA9 EZAIR™ Universal Applicator works with REEL SMART™ reel-fed terminals to deliver the ultimate fully automatic, high-capacity termination performance
- New PANDUIT reel and strip ferrules combine with tooling options to support wire harness, control panel, and automatic wire processing applications

PANDUIT continually provides new designs with innovative features to meet the application challenges encountered by customers, while providing the lowest installed cost.

A.
System
Overview

B1.
Cable Ties

B2.
Cable
Accessories

B3.
Stainless
Steel Ties

C1.
Wiring
Duct

C2.
Surface
Raceway

C3.
Abrasion
Protection

C4.
Cable
Management

D1.
Terminals

D2.
Power
Connectors

D3.
Grounding
Connectors

E1.
Labeling
Systems

E2.
Labels

E3.
Pre-Printed
& Write-On
Markers

E4.
Permanent
Identification

E5.
Lockout/
Tagout
& Safety
Solutions

F.
Index

A.
System
Overview

Features and Benefits – REEL SMART™ Termination System

The PANDUIT continuously molded REEL SMART™ products are designed such that the terminal, disconnect, and butt splice housings are connected by an integral molded carrier in the barrel crimp zone, producing a continuous length of product. Plated metal terminals, disconnects, and splices are then assembled into the housings. During termination, the continuously molded components are fed into a universal applicator. This process produces a reel-fed solution that eliminates a variety of problems associated with other reel-fed designs and provides high quality, high capacity product on reels for longer, uninterrupted production runs – resulting in the lowest installed cost.

B1.
Cable Ties

B2.
Cable
Accessories

B3.
Stainless
Steel Ties

C1.
Wiring
Duct

C2.
Surface
Raceway

C3.
Abrasion
Protection

C4.
Cable
Management

D1.
Terminals

D2.
Power
Connectors

D3.
Grounding
Connectors

E1.
Labeling
Systems

E2.
Labels

E3.
Pre-Printed
& Write-On
Markers

E4.
Permanent
Identification

E5.
Lockout/
Tagout/
& Safety
Solutions

F.
Index

Pre-insulated design eliminates the need for post-insulation – resulting in labor savings

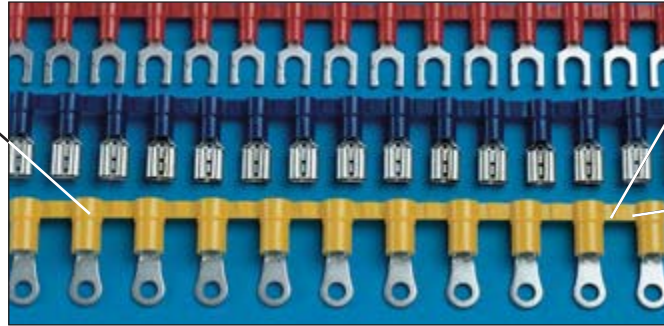

Continuously molded design always aligns product with the carrier strip – resulting in trouble free tool operation

Plastic carrier strip eliminates sharp, unplated edges as found on metal strip-fed carriers – providing better corrosion resistance

REEL SMART™ CA9 EZAIR™ Universal Applicator

The PANDUIT® CA9 EZAIR™ applicator automatically adjusts feed stroke to the correct pitch and length for the entire product line of continuously molded products. The need for multiple applicators is eliminated. The applicator, in conjunction with the precision, continuously molded product provides perfect front-to-back and side-to-side alignment in the die pocket for a high quality termination every time – resulting in the most optimum system to terminate terminals.

Automatic, self-adjusting feed stroke – resulting in correct pitch and length

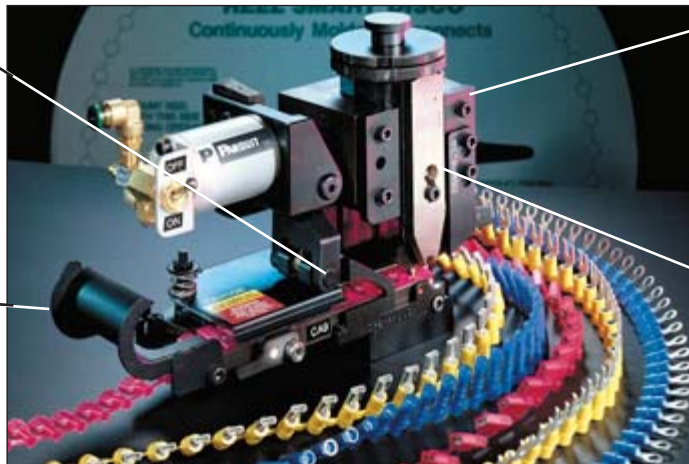

Universal applicator installs entire REEL SMART™ product line – resulting in lower tooling inventory costs

Versatile applicator design – allows for use in bench presses, and most automatic wire processing systems

Quick change dies – provide fast product change-over and reduction in set-up time

Nylon Insulated Terminals with Insulation Grip Sleeve (Funnel and Non-Funnel Entry Types)

The three-piece design terminal provides a permanently attached tin-plated brass sleeve for insulation grip in funnel and straight entry sleeve designs. This product feature offers the highest quality reliable terminations. Nylon insulation is rated up to 600 V maximum and designed for up to 221°F (105°C) operating temperature maximum. Supplied on rings, forks, locking forks, short locking forks and flanged forks in wire sizes #22 – 10.



- Sleeved barrel – assures crimp reliability
- PNF – funnel-entry styles available
- Metal insulation crimp – provides DOUBLE CRIMP wire insulation grip sleeve for high vibration or conductor strain environments

- Internal wire barrel serrations – assure good wired contact and maximum tensile strength
- Product markings – UL and CSA rated – up to 600 V, maximum operating temperature 221°F(105°C)

Part Number System for REEL SMART™ Terminals

P	NF	14	6	R	N	3K
Type	Insulation	Wire Range	Stud Size	Tongue Configuration	Special Configuration	Std. Pkg. Size
P = Terminal BS = Butt Splice	N = Nylon Insulated NF = Nylon Insulated Funnel Entry V = Vinyl Insulated	18 = #22 – 18 14 = #16 – 14 12 = #16 – 12 10 = #12 – 10	4 = #4 5 = #5 6 = #6 8 = #8 10 = #10 14 = 1/4" 56 = 5/16" 38 = 3/8"	R = Ring HDR = Heavy Duty Ring F = Fork FF = Fanged Fork LF = Locking Fork SLF = Short Locking Fork	N = Narrow Tongue W = Wide Tongue B = Butted Seam = Standard (leave blank)	2K = 2,000 pcs. 3K = 3,000 pcs.

UL LISTED SP® Ring Terminals, Nylon Insulated – Non-Funnel Entry

Type PN-R

- Continuously molded design provides reliable, consistent performance through the applicator for a high quality termination every time
- Ring tongue design assures a secure connection in high vibration applications
- Metal insulation grip sleeve crimps to wire insulation, providing protection to the crimp joint during high vibration applications
- Internal barrel serrations assure good wire contact and maximum tensile strength
- UL Flammability UL 94V-2/HB, maximum insulation temperature 221°F (105°C)
- UL and CSA rated up to 600 V per UL 486

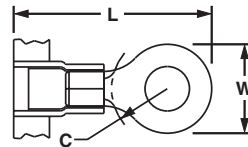

Part Number	Wire Range	Color Code	Stock Thickness	Max. Ins.	Stud Size	Figure Dimension (In.)			CA9 Series Crimp Die	CA-800 Series Crimp Die	Pieces Per Reel
						L	W	C			
PN18-4R-3K	22 – 18 AWG	Red	.03	.145	#4	.80	.25	.22	CD9-1A	CD-800-1	3000
PN18-6RN-3K					#6	.74	.22	.18			3000
PN18-6R-3K					#6	.78	.25	.22			3000
PN18-8R-3K					#8	.86	.31	.25			3000
PN18-10R-3K					#10	.86	.31	.25			3000
PN18-14R-3K					1/4"	1.05	.45	.38			3000
PN14-4R-3K	16 – 14 AWG	Blue	.03	.162	#4	.76	.25	.22	CD9-2A	CD-800-2	3000
PN14-6RN-3K					#6	.76	.25	.22			3000
PN14-6R-3K					#6	.86	.31	.25			3000
PN14-8R-3K					#8	.86	.31	.25			3000
PN14-10R-3K					#10	.86	.31	.25			3000
PN14-14R-3K					1/4"	1.06	.44	.38			3000
PN10-6R-2K	12 – 10 AWG	Yellow	.04	.225	#6	1.06	.38	.31	CD9-3B	CD-800-3	2000
PN10-8R-2K					#8	1.06	.38	.31			2000
PN10-10R-2K					#10	1.06	.38	.31			2000
PN10-14R-2K					1/4"	1.21	.52	.38			2000
PN10-56R-2K					5/16"	1.21	.52	.38			2000
PN10-38R-2K					3/8"	1.29	.58	.43			2000

For applicator information, see page D1.143.

A.
System
Overview



Ring Terminals, Nylon Insulated – Funnel Entry

B1.
Cable Ties

Type PNF-R

- Continuously molded design provides reliable, consistent performance through the applicator for a high quality termination every time
- Ring tongue design assures a secure connection in high vibration applications
- Metal insulation grip sleeve crimps to wire insulation, providing protection to the crimp joint during high vibration applications

- Internal barrel serrations assure good wire contact and maximum tensile strength
- UL Flammability UL 94V-2/HB, maximum insulation temperature 221°F (105°C)
- UL and CSA rated up to 600 V per UL 486

B2.
Cable
Accessories

B3.
Stainless
Steel Ties

C1.
Wiring
Duct

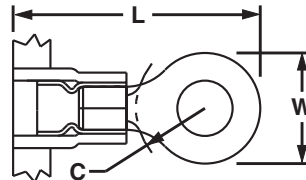

C2.
Surface
Raceway

C3.
Abrasion
Protection

C4.
Cable
Management

D1.
Terminals

D2.
Power
Connectors

D3.
Grounding
Connectors

E1.
Labeling
Systems

E2.
Labels

E3.
Pre-Printed
& Write-On
Markers

E4.
Permanent
Identification

E5.
Lockout/
Tagout
& Safety
Solutions

F.
Index

Part Number	Wire Range	Color Code	Stock Thickness	Max. Ins.	Stud Size	Figure Dimensions (In.)			CA9 Series Crimp Die	CA-800 Series Crimp Die	Pieces Per Reel
						L	W	C			
PNF18-4RN-3K	22 – 18 AWG	Red	.03	.145	#4	.74	.22	.19	CD9-1A	CD-800-1	3000
PNF18-4R-3K					#4	.78	.25	.21			3000
PNF18-6RN-3K					#6	.74	.22	.16			3000
PNF18-6R-3K					#6	.78	.25	.21			3000
PNF18-8R-3K					#8	.86	.31	.25			3000
PNF18-10R-3K					#10	.86	.31	.25			3000
PNF18-14R-3K					1/4"	1.06	.46	.38			3000
PNF14-4R-3K	16 – 14 AWG	Blue	.03	.162	#4	.78	.25	.18	CD9-2A	CD-800-2	3000
PNF14-6RN-3K					#6	.78	.25	.18			3000
PNF14-6R-3K					#6	.87	.31	.24			3000
PNF14-8R-3K					#8	.87	.31	.25			3000
PNF14-10R-3K					#10	.85	.31	.29			3000
PNF14-14R-3K					1/4"	1.06	.46	.40			3000
PNF10-6R-2K					12 – 10 AWG	Yellow	.04	.225			#6
PNF10-8R-2K	#8	1.06	.38	.31					2000		
PNF10-10R-2K	#10	1.06	.38	.31					2000		
PNF10-14R-2K	1/4"	1.21	.52	.38					2000		
PNF10-56R-2K	5/16"	1.21	.52	.38					2000		
PNF10-38R-2K	3/8"	1.29	.58	.43					2000		

For applicator information, see page D1.143.

UL LISTED CERTIFIED Ring Terminals, Vinyl Insulated – Funnel Entry

Type PV-RB

- Continuously molded design provides reliable, consistent performance through the applicator for a high quality termination every time
- Ring tongue design assures a secure connection in high vibration applications



- Insulation support helps to prevent wire damage in bending applications
- Maximum insulation temperature 221°F (105°C)
- UL and CSA rated up to 600 V per UL 486

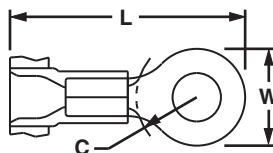

Part Number	Wire Range	Color Code	Stock Thickness	Max. Ins.	Stud Size	Figure Dimensions (In.)			CA9 Series Crimp Die	CA-800 Series Crimp Die	Pieces Per Reel						
						L	W	C									
PV18-4RNB-3K	22 – 18 AWG	Red	.03	.150	#4	.74	.21	.19	CD9-1A	CD-800-1	3000						
PV18-4RB-3K					#4	.78	.25	.20			3000						
PV18-6RNB-3K					#6	.75	.23	.19			3000						
PV18-6RB-3K					#6	.78	.25	.20			3000						
PV18-8RB-3K					#8	.86	.31	.25			3000						
PV18-10RB-3K					#10	.86	.31	.25			3000						
PV18-14RB-3K					1/4"	1.06	.45	.38			3000						
PV18-56RB-2K					5/16"	1.06	.46	.38			2000						
PV18-38RB-2K					3/8"	1.15	.53	.43			2000						
PV14-4RB-3K					16 – 14 AWG	Blue	.03	.170			#4	.76	.25	.22	CD9-2A	CD-800-2	3000
PV14-6RNB-3K	#6	.76	.25	.22					3000								
PV14-6RB-3K	#6	.86	.31	.25					3000								
PV14-8RB-3K	#8	.86	.31	.25					3000								
PV14-10RB-3K	#10	.86	.31	.25					3000								
PV14-14RB-3K	1/4"	1.05	.45	.38					3000								
PV14-56RB-2K	5/16"	1.06	.46	.38					2000								
PV14-38RB-2K	3/8"	1.15	.53	.43					2000								
PV10-6RB-2K	12 – 10 AWG	Yellow	.04	.225					#6	1.02	.31	.31	CD9-3B	CD-800-3			2000
PV10-8RB-2K									#8	1.02	.31	.31					2000
PV10-10RB-2K					#10	1.02	.31	.31	2000								
PV10-14RB-2K					1/4"	1.20	.52	.38	2000								
PV10-56RB-2K					5/16"	1.20	.52	.38	2000								
PV10-38RB-2K					3/8"	1.23	.58	.38	2000								

For applicator information, see page D1.143.

UL LISTED CERTIFIED Multiple Stud Ring Terminals, Vinyl Insulated – Funnel Entry

Type PV-610RB

- Continuously molded design provides reliable, consistent performance through the applicator for a high quality termination every time
- Teardrop shaped mounting hole of multiple stud terminals permits use with #6, #8, or #10 size studs
- Ring tongue design assures a secure connection in high vibration applications



- Insulation support helps to prevent wire damage in bending applications
- Maximum insulation temperature 221°F (105°C)
- UL and CSA rated up to 600 V per UL 486

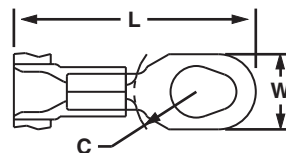

Part Number	Wire Range	Color Code	Stock Thickness	Max. Ins.	Stud Size	Figure Dimensions (In.)			CA9 Series Crimp Die	CA-800 Series Crimp Die	Pieces Per Reel
						L	W	C			
PV18-610RB-3K	22 – 18 AWG	Red	.03	.150	#6, #8, #10	.95	.31	.25	CD9-1A	CD-800-1	3000
PV14-610RB-3K	16 – 14 AWG	Blue	.03	.170		.95	.31	.25	CD9-2A	CD-800-2	3000
PV10-610RB-2K	12 – 10 AWG	Yellow	.04	.225		1.17	.37	.31	CD9-3B	CD-800-3	2000

For applicator information, see page D1.143.

A. System Overview

B1. Cable Ties

B2. Cable Accessories

B3. Stainless Steel Ties

C1. Wiring Duct

C2. Surface Raceway

C3. Abrasion Protection

C4. Cable Management

D1. Terminals

D2. Power Connectors

D3. Grounding Connectors

E1. Labeling Systems

E2. Labels

E3. Pre-Printed & Write-On Markers

E4. Permanent Identification

E5. Lockout/Tagout & Safety Solutions

F. Index

A. System Overview



Ring Terminals, Nylon Insulated – Heavy Duty

Type PN-HDR

- Continuously molded design provides reliable, consistent performance through the applicator for a high quality termination every time
- Manufactured from stock 56% thicker than a standard #16 – 14 AWG terminal for use in heavy duty applications
- Insulation housing is marked with “HDR” to signify heavy duty ring
- Metal insulation grip sleeve crimps to wire insulation, providing protection to the crimp joint during high vibration applications
- Internal barrel serrations assure good wire contact and maximum tensile strength
- UL Flammability UL 94V-2/HB, maximum insulation temperature 221°F (105°C)
- UL and CSA rated up to 600 V per UL 486

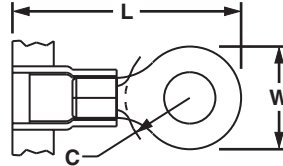

B1. Cable Ties

B2. Cable Accessories

B3. Stainless Steel Ties

C1. Wiring Duct

C2. Surface Raceway

C3. Abrasion Protection

C4. Cable Management

Part Number	Wire Range	Color Code	Stock Thickness	Max. Ins.	Stud Size	Figure Dimensions (In.)			CA9 Series Crimp Die	CA-800 Series Crimp Die	Pieces Per Reel
						L	W	C			
PN12-6HDR-2K	16 – 12 AWG	Yellow	.05	.225	#6	1.02	.31	.31	CD9-3B	CD-800-3	2000
PN12-8HDR-2K					#8	1.02	.31	.31			2000
PN12-10HDR-2K					#10	1.05	.38	.31			2000
PN12-14HDR-2K					1/4"	1.20	.52	.38			2000
PN12-56HDR-2K					5/16"	1.20	.52	.38			2000
PN12-38HDR-2K					3/8"	1.28	.58	.38			2000

For applicator information, see page D1.143.

D1. Terminals



Ring Terminals, Vinyl Insulated – Heavy Duty

Type PV-HDRB

- Continuously molded design provides reliable, consistent performance through the applicator for a high quality termination every time
- Manufactured from stock 56% thicker than a standard #16 – 14 AWG terminal for use in heavy duty applications
- Insulation housing is marked with “HDR” to signify heavy duty ring
- Insulation support helps to prevent wire damage in bending applications
- Maximum insulation temperature 221°F (105°C)
- UL and CSA rated up to 600 V per UL 486

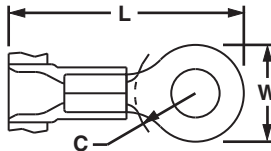

D2. Power Connectors

D3. Grounding Connectors

E1. Labeling Systems

E2. Labels

E3. Pre-Printed & Write-On Markers

E4. Permanent Identification

E5. Lockout/Tagout & Safety Solutions

F. Index

Part Number	Wire Range	Color Code	Stock Thickness	Max. Ins.	Stud Size	Figure Dimensions (In.)			CA9 Series Crimp Die	CA-800 Series Crimp Die	Pieces Per Reel
						L	W	C			
PV12-6HDRB-2K	16 – 12 AWG	Yellow	.05	.225	#6	1.03	.31	.36	CD9-3B	CD-800-3	2000
PV12-8HDRB-2K					#8	1.03	.31	.36			2000
PV12-10HDRB-2K					#10	1.06	.37	.36			2000
PV12-14HDRB-2K					1/4"	1.23	.52	.43			2000
PV12-56HDRB-2K					5/16"	1.23	.52	.43			2000
PV12-38HDRB-2K					3/8"	1.30	.58	.48			2000

For applicator information, see page D1.143.



Fork Terminals, Nylon Insulated – Non-Funnel Entry

Type PN-F

- Continuously molded design provides reliable, consistent performance through the applicator for a high quality termination every time
- Fork design provides for fast and easy installation, without the need to remove fastener
- Metal insulation grip sleeve crimps to wire insulation, providing protection to the crimp joint during high vibration applications
- Internal barrel serrations assure good wire contact and maximum tensile strength
- UL Flammability UL 94V-2/HB, maximum insulation temperature 221°F (105°C)
- UL and CSA rated up to 600 V per UL 486

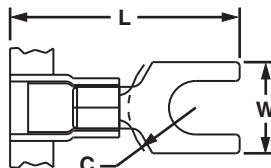

Part Number	Wire Range	Color Code	Stock Thickness	Max. Ins.	Stud Size	Figure Dimensions (In.)			CA9 Series Crimp Die	CA-800 Series Crimp Die	Pieces Per Reel
						L	W	C			
PN18-6FN-3K	22 – 18 AWG	Red	.03	.145	#6	.78	.25	.20	CD9-1A	CD-800-1	3000
PN18-6F-3K					#6	.78	.30	.20			3000
PN18-8F-3K					#8	.84	.32	.23			3000
PN18-10FN-3K					#10	.86	.31	.25			3000
PN18-10F-3K					#10	.86	.35	.25			3000
PN18-14F-3K					1/4"	1.03	.44	.33			3000
PN14-6FN-3K	16 – 14 AWG	Blue	.03	.162	#6	.78	.24	.19	CD9-2A	CD-800-2	3000
PN14-6F-3K					#6	.78	.28	.19			3000
PN14-8F-3K					#8	.84	.31	.23			3000
PN14-10FN-3K					#10	.86	.31	.24			3000
PN14-10F-3K					#10	.86	.34	.24			3000
PN14-14F-3K					1/4"	1.03	.44	.32			3000
PN10-6F-2K	12 – 10 AWG	Yellow	.04	.225	#6	1.00	.31	.24	CD9-3B	CD-800-3	2000
PN10-8F-2K					#8	1.03	.37	.24			2000
PN10-10F-2K					#10	1.04	.37	.24			2000
PN10-14F-2K					1/4"	1.14	.49	.32			2000

For applicator information, see page D1.143.

A. System Overview

B1. Cable Ties

B2. Cable Accessories

B3. Stainless Steel Ties

C1. Wiring Duct

C2. Surface Raceway

C3. Abrasion Protection

C4. Cable Management

D1. Terminals

D2. Power Connectors

D3. Grounding Connectors

E1. Labeling Systems

E2. Labels

E3. Pre-Printed & Write-On Markers

E4. Permanent Identification

E5. Lockout/Tagout & Safety Solutions

F. Index

A.
System
Overview



Fork Terminals, Nylon Insulated – Funnel Entry

B1.
Cable Ties

Type PNF-F

- Continuously molded design provides reliable, consistent performance through the applicator for a high quality termination every time
- Fork design provides for fast and easy installation, without the need to remove fastener
- Metal insulation grip sleeve crimps to wire insulation, providing protection to the crimp joint during high vibration applications

- Internal barrel serrations assure good wire contact and maximum tensile strength
- UL Flammability UL 94V-2/HB, maximum insulation temperature 221°F (105°C)
- UL and CSA rated up to 600 V per UL 486

B2.
Cable
Accessories

B3.
Stainless
Steel Ties

C1.
Wiring
Duct

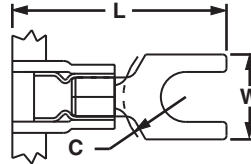

C2.
Surface
Raceway

C3.
Abrasion
Protection

C4.
Cable
Management

D1.
Terminals

D2.
Power
Connectors

D3.
Grounding
Connectors

E1.
Labeling
Systems

E2.
Labels

E3.
Pre-Printed
& Write-On
Markers

E4.
Permanent
Identification

E5.
Lockout/
Tagout/
& Safety
Solutions

F.
Index

Part Number	Wire Range	Color Code	Stock Thickness	Max. Ins.	Stud Size	Figure Dimensions (In.)			CA9 Series Crimp Die	CA-800 Series Crimp Die	Pieces Per Reel
						L	W	C			
PNF18-6F-3K	22 – 18 AWG	Red	.03	.145	#6	.77	.24	.19	CD9-1A	CD-800-1	3000
PNF18-6FN-3K					#6	.78	.30	.19			3000
PNF18-8F-3K					#8	.83	.32	.22			3000
PNF18-10F-3K					#10	.85	.35	.24			3000
PNF18-14F-3K					1/4"	1.02	.44	.33			3000
PNF14-6FN-3K*	16 – 14 AWG	Blue	.03	.162	#6	.78	.24	.19	CD9-2A	CD-800-2	3000
PNF14-6F-3K					#6	.78	.28	.19			3000
PNF14-8F-3K					#8	.84	.31	.23			3000
PNF14-10F-3K					#10	.86	.34	.24			3000
PNF14-14F-3K					1/4"	1.03	.44	.32			3000
PNF10-6F-2K	12 – 10 AWG	Yellow	.04	.225	#6	1.01	.31	.24	CD9-3B	CD-800-3	2000
PNF10-8F-2K					#8	1.02	.37	.24			2000
PNF10-10F-2K					#10	1.02	.37	.22			2000
PNF10-14F-2K					1/4"	1.13	.49	.32			2000

*Not UL Listed or CSA Certified.
For applicator information, see page D1.143.



Fork Terminals, Vinyl Insulated – Funnel Entry

Type PV-FB

- Continuously molded design provides reliable, consistent performance through the applicator for a high quality termination every time
- Fork design provides for fast and easy installation, without the need to remove fastener
- Insulation support helps to prevent wire damage in bending applications
- Maximum insulation temperature 221°F (105°C)
- UL and CSA rated up to 600 V per UL 486

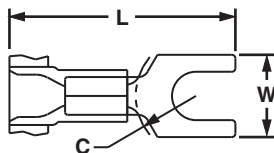

Part Number	Wire Range	Color Code	Stock Thickness	Max. Ins.	Stud Size	Figure Dimensions (In.)			CA9 Series Crimp Die	CA-800 Series Crimp Die	Pieces Per Reel
						L	W	C			
PV18-6FB-3K	22 – 18 AWG	Red	.03	.150	#6	.78	.25	.20	CD9-1A	CD-800-1	3000
PV18-6FNB-3K					#6	.78	.30	.20			3000
PV18-8FB-3K					#8	.84	.32	.23			3000
PV18-10FB-3K					#10	.86	.35	.25			3000
PV18-14FB-3K					1/4"	1.03	.44	.33			3000
PV14-6FB-3K	16 – 14 AWG	Blue	.03	.170	#6	.78	.24	.19	CD9-2A	CD-800-2	3000
PV14-6FNB-3K*					#6	.78	.28	.19			3000
PV14-8FB-3K					#8	.84	.31	.23			3000
PV14-10FB-3K					#10	.86	.31	.24			3000
PV14-10FNB-3K*					#10	.86	.34	.24			3000
PV14-14FB-3K	1/4"	1.03	.44	.32	3000						
PV10-6FB-2K	12 – 10 AWG	Yellow	.04	.225	#6	.99	.31	.22	CD9-3B	CD-800-3	2000
PV10-8FB-2K					#8	1.00	.38	.22			2000
PV10-10FB-2K					#10	1.04	.38	.22			2000
PV10-14FB-2K					1/4"	1.13	.49	.32			2000

*CSA Certified only.

For applicator information, see page D1.143.

A. System Overview

B1. Cable Ties

B2. Cable Accessories

B3. Stainless Steel Ties

C1. Wiring Duct

C2. Surface Raceway

C3. Abrasion Protection

C4. Cable Management

D1. Terminals

D2. Power Connectors

D3. Grounding Connectors

E1. Labeling Systems

E2. Labels

E3. Pre-Printed & Write-On Markers

E4. Permanent Identification

E5. Lockout/Tagout & Safety Solutions

F. Index

A. System Overview



Locking Fork Terminals, Nylon Insulated – Non-Funnel Entry

Type PN-LF

- Continuously molded design provides reliable, consistent performance through the applicator for a high quality termination every time
- Lock in place for secure connection
- Fork design provides for fast and easy installation, without the need to remove fastener
- Metal insulation grip sleeve crimps to wire insulation, providing protection to the crimp joint during high vibration applications

- Internal barrel serrations assure good wire contact and maximum tensile strength
- UL Flammability UL 94V-2/HB, maximum insulation temperature 221°F (105°C)
- UL and CSA rated up to 600 V per UL 486

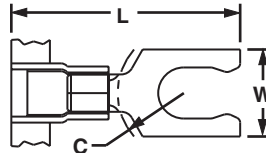

B1. Cable Ties

B2. Cable Accessories

B3. Stainless Steel Ties

C1. Wiring Duct

C2. Surface Raceway

C3. Abrasion Protection

C4. Cable Management

Part Number	Wire Range	Color Code	Stock Thickness	Max. Ins.	Stud Size	Figure Dimensions (In.)			CA9 Series Crimp Die	CA-800 Series Crimp Die	Pieces Per Reel
						L	W	C			
PN18-6LF-3K	22 – 18 AWG	Red	.03	.145	#6	.82	.24	.19	CD9-1A	CD-800-1	3000
PN18-8LF-3K					#8	.89	.29	.23			3000
PN18-10LF-3K					#10	.89	.33	.23			3000
PN14-6LF-3K	16 – 14 AWG	Blue	.03	.162	#6	.85	.25	.18	CD9-2A	CD-800-2	3000
PN14-8LF-3K					#8	.92	.29	.23			3000
PN14-10LF-3K					#10	.92	.33	.23			3000
PN10-6LF-2K	12 – 10 AWG	Yellow	.04	.225	#6	1.02	.30	.21	CD9-3B	CD-800-3	2000
PN10-8LF-2K					#8	1.05	.30	.21			2000
PN10-10LF-2K					#10	1.05	.34	.21			2000

For applicator information, see page D1.143.

D1. Terminals



Locking Fork Terminals, Nylon Insulated – Funnel Entry

Type PNF-LF

- Continuously molded design provides reliable, consistent performance through the applicator for a high quality termination every time
- Lock in place for secure connection
- Fork design provides for fast and easy installation, without the need to remove fastener
- Metal insulation grip sleeve crimps to wire insulation, providing protection to the crimp joint during high vibration applications

- Internal barrel serrations assure good wire contact and maximum tensile strength
- UL Flammability UL 94V-2/HB, maximum insulation temperature 221°F (105°C)
- UL and CSA rated up to 600 V per UL 486

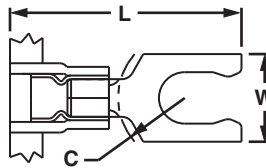

E1. Labeling Systems

E2. Labels

E3. Pre-Printed & Write-On Markers

E4. Permanent Identification

E5. Lockout/Tagout & Safety Solutions

F. Index

Part Number	Wire Range	Color Code	Stock Thickness	Max. Ins.	Stud Size	Figure Dimensions (In.)			CA9 Series Crimp Die	CA-800 Series Crimp Die	Pieces Per Reel
						L	W	C			
PNF18-6LF-3K	22 – 18 AWG	Red	.03	.145	#6	.85	.27	.19	CD9-1A	CD-800-1	3000
PNF18-6LFW-3K					#6	.85	.29	.19			3000
PNF18-8LF-3K					#8	.89	.29	.23			3000
PNF18-10LF-3K	16 – 14 AWG	Blue	.03	.162	#10	.89	.33	.23	CD9-2A	CD-800-2	3000
PNF14-6LF-3K					#6	.85	.25	.18			3000
PNF14-8LF-3K					#8	.92	.29	.23			3000
PNF14-10LFN-3K	12 – 10 AWG	Yellow	.04	.225	#10	.92	.28	.23	CD9-3B	CD-800-3	3000
PNF14-10LF-3K					#10	.92	.33	.23			3000
PNF10-6LF-2K	12 – 10 AWG	Yellow	.04	.225	#6	1.02	.30	.21	CD9-3B	CD-800-3	2000
PNF10-8LF-2K					#8	1.05	.30	.21			2000
PNF10-10LF-2K					#10	1.05	.34	.21			2000
PNF10-14LF-2K					1/4"	1.19	.46	.32			2000

For applicator information, see page D1.143.



Locking Fork Terminals, Vinyl Insulated – Funnel Entry

Type PV-LFB

- Continuously molded design provides reliable, consistent performance through the applicator for a high quality termination every time
- Lock in place for secure connection
- Fork design provides for fast and easy installation, without the need to remove fastener
- Insulation support helps to prevent wire damage in bending applications
- Maximum insulation temperature 221°F (105°C)
- UL and CSA rated to 600 V per UL 486

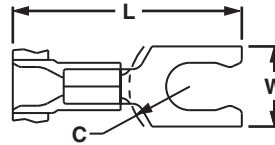

Part Number	Wire Range	Color Code	Stock Thickness	Max. Ins.	Stud Size	Figure Dimensions (In.)			CA9 Series Crimp Die	CA-800 Series Crimp Die	Pieces Per Reel
						L	W	C			
PV18-6LFB-3K	22 – 18 AWG	Red	.03	.150	#6	.80	.27	.19	CD9-1A	CD-800-1	3000
PV18-6LFWB-3K					#6	.83	.29	.19			3000
PV18-8LFB-3K					#8	.87	.29	.23			3000
PV18-10LFNB-3K*					#10	.87	.29	.23			3000
PV18-10LFB-3K					#10	.87	.33	.23			3000
PV14-6LFB-3K	16 – 14 AWG	Blue	.03	.170	#6	.85	.25	.18	CD9-2A	CD-800-2	3000
PV14-6LFWB-3K					#6	.85	.29	.18			3000
PV14-8LFB-3K					#8	.92	.29	.23			3000
PV14-10LFB-3K					#10	.92	.33	.23			3000
PV10-6LFB-2K	12 – 10 AWG	Yellow	.04	.225	#6	1.02	.30	.21	CD9-3B	CD-800-3	2000
PV10-8LFB-2K					#8	1.04	.30	.21			2000
PV10-10LFB-2K					#10	1.04	.34	.21			2000
PV10-14LFB-2K					1/4"	1.16	.46	.32			2000

*Not UL Listed or CSA Certified.

For applicator information, see page D1.143.

A. System Overview

B1. Cable Ties

B2. Cable Accessories

B3. Stainless Steel Ties

C1. Wiring Duct

C2. Surface Raceway

C3. Abrasion Protection

C4. Cable Management

D1. Terminals

D2. Power Connectors

D3. Grounding Connectors

E1. Labeling Systems

E2. Labels

E3. Pre-Printed & Write-On Markers

E4. Permanent Identification

E5. Lockout/Tagout & Safety Solutions

F. Index

A. System Overview



Short Locking Fork Terminals, Nylon Insulated – Non-Funnel Entry

Type PN-SLF

- Continuously molded design provides reliable, consistent performance through the applicator for a high quality termination every time
- Lock in place for a secure connection in limited spaces
- Fork design provides for fast and easy installation, without the need to remove fastener
- Metal insulation grip sleeve crimps to wire insulation, providing protection to the crimp joint during high vibration applications

- Internal barrel serrations assure good wire contact and maximum tensile strength
- UL Flammability UL 94V-2/HB, maximum insulation temperature 221°F (105°C)
- UL and CSA rated up to 600 V per UL 486

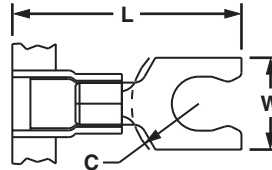

B1. Cable Ties

B2. Cable Accessories

B3. Stainless Steel Ties

C1. Wiring Duct

C2. Surface Raceway

C3. Abrasion Protection

C4. Cable Management

Part Number	Wire Range	Color Code	Stock Thickness	Max. Ins.	Stud Size	Figure Dimensions (In.)			CA9 Series Crimp Die	CA-800 Series Crimp Die	Pieces Per Reel
						L	W	C			
PN18-5SLF-3K	22 – 18 AWG	Red	.03	.145	#5	.75	.26	.19	CD9-1A	CD-800-1	3000
PN18-6SLF-3K					#6	.75	.27	.19			3000
PN18-8SLF-3K					#8	.79	.29	.23			3000
PN18-10SLF-3K					#10	.80	.33	.23			3000
PN14-5SLF-3K	16 – 14 AWG	Blue	.03	.162	#5	.75	.25	.19	CD9-2A	CD-800-2	3000
PN14-6SLF-3K					#6	.75	.25	.19			3000
PN14-8SLF-3K					#8	.80	.29	.23			3000
PN14-10SLF-3K					#10	.81	.33	.23			3000
PN10-8SLF-2K	12 – 10 AWG	Yellow	.04	.225	#8	.92	.29	.22	CD9-3B	CD-800-3	2000
PN10-10SLF-2K					#10	.92	.33	.22			2000

For applicator information, see page D1.143.

D1. Terminals



Short Locking Fork Terminals, Nylon Insulated – Funnel Entry

Type PNF-SLF

- Continuously molded design provides reliable, consistent performance through the applicator for a high quality termination every time
- Lock in place for a secure connection in limited spaces
- Fork design provides for fast and easy installation, without the need to remove fastener
- Metal insulation grip sleeve crimps to wire insulation, providing protection to the crimp joint during high vibration applications

- Internal barrel serrations assure good wire contact and maximum tensile strength
- UL Flammability UL 94V-2/HB, maximum insulation temperature 221°F (105°C)
- UL and CSA rated up to 600 V per UL 486

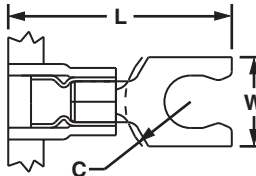

D2. Power Connectors

D3. Grounding Connectors

E1. Labeling Systems

E2. Labels

E3. Pre-Printed & Write-On Markers

E4. Permanent Identification

E5. Lockout/Tagout & Safety Solutions

F. Index

Part Number	Wire Range	Color Code	Stock Thickness	Max. Ins.	Stud Size	Figure Dimensions (In.)			CA9 Series Crimp Die	CA-800 Series Crimp Die	Pieces Per Reel
						L	W	C			
PNF18-5SLF-3K	22 – 18 AWG	Red	.03	.145	#5	.73	.26	.19	CD9-1A	CD-800-1	3000
PNF18-6SLF-3K					#6	.74	.27	.19			3000
PNF18-8SLF-3K					#8	.80	.29	.23			3000
PNF18-10SLF-3K					#10	.80	.33	.23			3000
PNF14-6SLF-3K	16 – 14 AWG	Blue	.03	.162	#6	.75	.25	.19	CD9-2A	CD-800-2	3000
PNF14-10SLF-3K					#10	.81	.33	.23			3000
PNF10-6SLF-2K	12 – 10 AWG	Yellow	.04	.225	#6	.91	.25	.17	CD9-3B	CD-800-3	2000
PNF10-8SLF-2K					#8	.92	.29	.22			2000
PNF10-10SLF-2K					#10	.93	.33	.22			2000

For applicator information, see page D1.143.



Short Locking Fork Terminals, Vinyl Insulated – Funnel Entry

Type PV-SLFB

- Continuously molded design provides reliable, consistent performance through the applicator for a high quality termination every time
- Lock in place for a secure connection in limited spaces
- Fork design provides for fast and easy installation, without the need to remove fastener

- Insulation support helps to prevent wire damage in bending applications
- Maximum insulation temperature 221°F (105°C)
- UL and CSA rated up to 600 V per UL 486

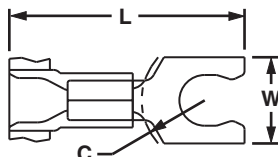

Part Number	Wire Range	Color Code	Stock Thickness	Max. Ins.	Stud Size	Figure Dimensions (In.)			CA9 Series Crimp Die	CA-800 Series Crimp Die	Pieces Per Reel
						L	W	C			
PV18-5SLFB-3K	22 – 18 AWG	Red	.03	.150	#5	.72	.26	.19	CD9-1A	CD-800-1	3000
PV18-6SLFB-3K					#6	.72	.27	.19			3000
PV18-8SLFB-3K					#8	.77	.29	.23			3000
PV18-10SLFB-3K					#10	.78	.33	.23			3000
PV14-6SLFB-3K	16 – 14 AWG	Blue	.03	.170	#6	.75	.25	.19	CD9-2A	CD-800-2	3000
PV14-8SLFB-3K					#8	.80	.29	.23			3000
PV14-10SLFB-3K					#10	.81	.33	.23			3000
PV14-14SLFB-3K					1/4"	.90	.44	.29			3000
PV10-6SLFB-2K	12 – 10 AWG	Yellow	.04	.225	#6	.84	.25	.17	CD9-3B	CD-800-3	2000
PV10-8SLFB-2K					#8	.90	.29	.22			2000
PV10-10SLFB-2K					#10	.91	.33	.22			2000

For applicator information, see page D1.143.



Flanged Fork Terminals, Nylon Insulated – Non-Funnel Entry

Type PN-FF

- Continuously molded design provides reliable, consistent performance through the applicator for a high quality termination every time
- Flange design provides extra secure connection on a variety of applications
- Metal insulation grip sleeve crimps to wire insulation, providing protection to the crimp joint during high vibration applications

- Internal barrel serrations assure good wire contact and maximum tensile strength
- UL Flammability UL 94V-2/HB, maximum insulation temperature 221°F (105°C)
- UL and CSA rated up to 600 V per UL 486

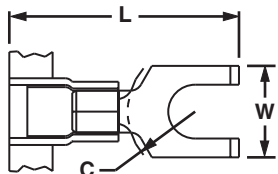

Part Number	Wire Range	Color Code	Stock Thickness	Max. Ins.	Stud Size	Figure Dimensions (In.)			CA9 Series Crimp Die	CA-800 Series Crimp Die	Pieces Per Reel
						L	W	C			
PN18-6FF-3K	22 – 18 AWG	Red	.03	.136	#6	.80	.28	.19	CD9-1A	CD-800-1	3000
PN18-8FF-3K					#8	.87	.31	.23			3000
PN18-10FF-3K					#10	.87	.35	.23			3000
PN14-6FF-3K	16 – 14 AWG	Blue	.03	.162	#6	.80	.28	.19	CD9-2A	CD-800-2	3000
PN14-8FF-3K					#8	.87	.31	.23			3000
PN14-10FF-3K					#10	.87	.35	.23			3000
PN10-8FF-2K	12 – 10 AWG	Yellow	.04	.225	#8	1.05	.38	.22	CD9-3B	CD-800-3	2000
PN10-10FF-2K					#10	1.05	.38	.22			2000

For applicator information, see page D1.143.

A. System Overview

B1. Cable Ties

B2. Cable Accessories

B3. Stainless Steel Ties

C1. Wiring Duct

C2. Surface Raceway

C3. Abrasion Protection

C4. Cable Management

D1. Terminals

D2. Power Connectors

D3. Grounding Connectors

E1. Labeling Systems

E2. Labels

E3. Pre-Printed & Write-On Markers

E4. Permanent Identification

E5. Lockout/Tagout & Safety Solutions

F. Index

A. System Overview



Flanged Fork Terminals, Nylon Insulated – Funnel Entry

Type PNF-FF

- Continuously molded design provides reliable, consistent performance through the applicator for a high quality termination every time
- Flange design provides extra secure connection on a variety of applications
- Metal insulation grip sleeve crimps to wire insulation, providing protection to the crimp joint during high vibration applications

- Internal barrel serrations assure good wire contact and maximum tensile strength
- UL Flammability UL 94V-2/HB, maximum insulation temperature 221°F (105°C)
- UL and CSA rated up to 600 V per UL 486

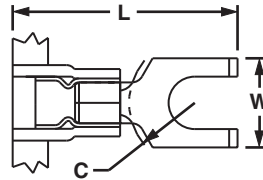

B1. Cable Ties

B2. Cable Accessories

B3. Stainless Steel Ties

C1. Wiring Duct

C2. Surface Raceway

C3. Abrasion Protection

C4. Cable Management

Part Number	Wire Range	Color Code	Stock Thickness	Max. Ins.	Stud Size	Figure Dimensions (In.)			CA9 Series Crimp Die	CA-800 Series Crimp Die	Pieces Per Reel
						L	W	C			
PNF18-6FF-3K	22 – 18 AWG	Red	.03	.145	#6	.80	.28	.19	CD9-1A	CD-800-1	3000
PNF18-8FF-3K					#8	.87	.31	.23			3000
PNF18-10FF-3K					#10	.86	.35	.23			3000
PNF14-6FF-3K	16 – 14 AWG	Blue	.03	.162	#6	.80	.28	.19	CD9-2A	CD-800-2	3000
PNF14-8FF-3K					#8	.87	.31	.23			3000
PNF14-10FF-3K					#10	.87	.35	.23			3000
PNF10-8FF-2K	12 – 10 AWG	Yellow	.04	.225	#8	1.05	.38	.24	CD9-3B	CD-800-3	2000
PNF10-10FF-2K					#10	1.05	.38	.24			2000

For applicator information, see page D1.143.

D1. Terminals



Flanged Fork Terminals, Vinyl Insulated – Funnel Entry

Type PV-FFB

- Continuously molded design provides reliable, consistent performance through the applicator for a high quality termination every time
- Flange design provides extra secure connection on a variety of applications

- Insulation support helps to prevent wire damage in bending applications
- Maximum insulation temperature 221°F (105°C)
- UL and CSA rated up to 600 V per UL 486

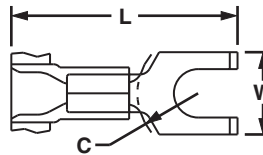

E1. Labeling Systems

E2. Labels

E3. Pre-Printed & Write-On Markers

E4. Permanent Identification

E5. Lockout/Tagout & Safety Solutions

Part Number	Wire Range	Color Code	Stock Thickness	Max. Ins.	Stud Size	Figure Dimensions (In.)			CA9 Series Crimp Die	CA-800 Series Crimp Die	Pieces Per Reel
						L	W	C			
PV18-6FFB-3K	22 – 18 AWG	Red	.03	.150	#6	.80	.28	.19	CD9-1A	CD-800-1	3000
PV18-8FFB-3K					#8	.87	.31	.23			3000
PV18-10FFB-3K					#10	.86	.35	.23			3000
PV14-6FFB-3K	16 – 14 AWG	Blue	.03	.170	#6	.80	.28	.19	CD9-2A	CD-800-2	3000
PV14-8FFB-3K					#8	.86	.31	.23			3000
PV14-10FFB-3K					#10	.86	.35	.23			3000
PV10-8FFB-2K	12 – 10 AWG	Yellow	.04	.225	#8	1.03	.37	.22	CD9-3B	CD-800-3	2000
PV10-10FFB-2K					#10	1.03	.37	.22			2000

For applicator information, see page D1.143.

F. Index

Features and Benefits – REEL SMART™ Metric Terminals

Metric Nylon Insulated Funnel Terminals with Insulation Grip Sleeve Type PMN or PMNF

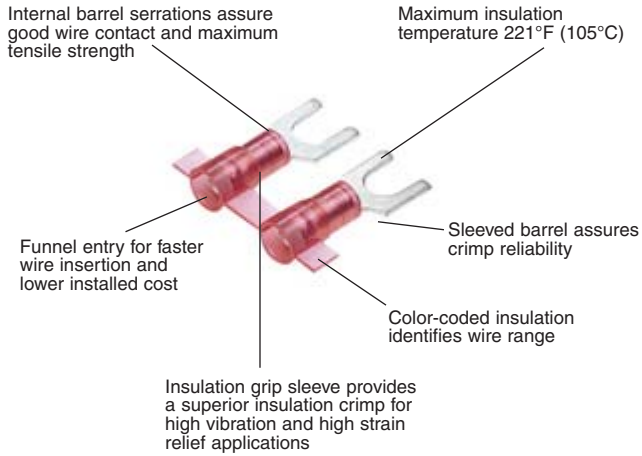

Flammability UL 94V-2/HB

Metric Nylon Insulated Funnel Terminals with Insulation Support Type PMV

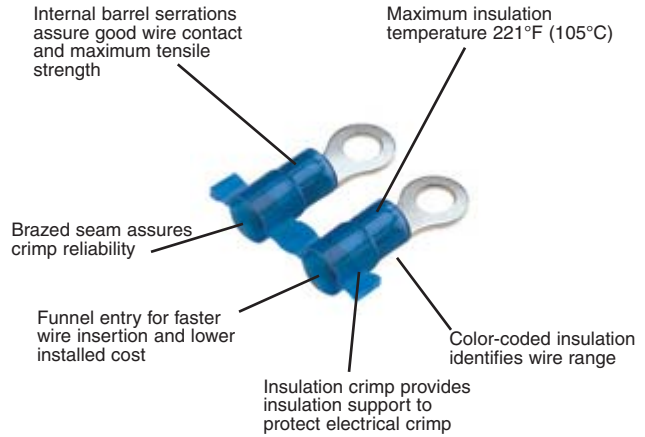

Flammability UL 94V-0

Part Number System for REEL SMART™ Metric Terminals

PM	V	1	—	3	R	B	3K
Type	Insulation	Wire Range	Stud Size	Tongue Configuration	Special Configuration	Std. Pkg. Size	
PM = PAN-TERM® Metric	N = Nylon NF = Nylon Funnel Entry V = Vinyl	1 = .5 – 1.0mm ² or .5 – 1.5mm ² 2 = 1.5 – 2.5mm ² 6 = 2.5 – 6.0mm ² or 4.0 – 6.0mm ²	3 = M3 (#5) 35 = M3.5 (#6) 4 = M4 (#8) 5 = M5 (#10) 6 = M6 (1/4") 8 = M8 (5/16")	R = Ring F = Fork	B = Butted Seam = Standard (leave blank)	2K = 2,000 pcs. 3K = 3,000 pcs.	

A. System Overview

B1. Cable Ties

B2. Cable Accessories

B3. Stainless Steel Ties

C1. Wiring Duct

C2. Surface Raceway

C3. Abrasion Protection

C4. Cable Management

D1. Terminals

D2. Power Connectors

D3. Grounding Connectors

E1. Labeling Systems

E2. Labels

E3. Pre-Printed & Write-On Markers

E4. Permanent Identification

E5. Lockout/Tagout & Safety Solutions

F. Index



Metric Ring Terminals, Nylon Insulated – Non-Funnel Entry

Type PMN-R

- Continuously molded design provides reliable, consistent performance through the applicator for a high quality termination every time
- Ring tongue design assures a secure connection in high vibration applications

- Metal insulation grip sleeve crimps to wire insulation, providing protection to the crimp joint during high vibration applications
- Internal barrel serrations assure good wire contact and maximum tensile strength

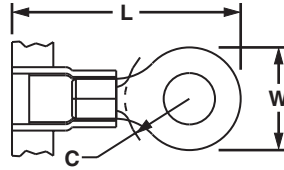

Part Number	Wire Range (mm ²)	Color Code	Max. Ins.	Stud Size (mm)	Figure Dimensions (mm)			CA9 Series Crimp Die	CA-800 Series Crimp Die	Pieces Per Reel
					L	W	C			
PMN1-3R-3K	.5 – 1.5	Red	3.7	M3	19.3	5.8	5.2	CD9-1A	CD-800-1	3000
PMN1-35R-3K				M3.5	19.3	5.8	5.2			3000
PMN1-4R-3K				M4	21.9	7.9	6.4			3000
PMN1-5R-3K				M5	22.4	8.9	6.4			3000
PMN1-6R-3K				M6	26.7	10.9	9.7			3000
PMN2-3R-3K	1.5 – 2.5	Blue	4.1	M3	21.6	5.8	5.1	CD9-2A	CD-800-2	3000
PMN2-35R-3K				M3.5	21.6	5.8	5.1			3000
PMN2-4R-3K				M4	24.1	7.9	6.5			3000
PMN2-5R-3K				M5	24.6	8.9	6.5			3000
PMN2-6R-3K				M6	26.7	10.9	9.7			3000
PMN6-3R-2K	2.5 – 6.0	Yellow	5.7	M3	24.7	5.8	7.9	CD9-3B	CD-800-3	2000
PMN6-35R-2K				M3.5	24.7	5.8	7.9			2000
PMN6-4R-2K				M4	25.7	7.9	7.9			2000
PMN6-5R-2K				M5	26.4	9.7	7.9			2000
PMN6-6R-2K				M6	29.0	10.9	9.7			2000
PMN6-8R-2K				M8	30.0	13.2	9.7			2000

For applicator information, see page D1.143.



Metric Ring Terminals, Nylon Insulated – Funnel Entry



Type PMNF-R

- Continuously molded design provides reliable, consistent performance through the applicator for a high quality termination every time
- Ring tongue design assures a secure connection in high vibration applications
- Metal insulation grip sleeve crimps to wire insulation, providing protection to the crimp joint during high vibration applications
- Internal barrel serrations assure good wire contact and maximum tensile strength

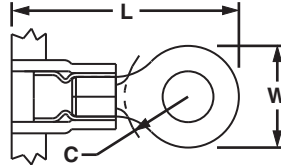

Part Number	Wire Range (mm ²)	Color Code	Max. Ins.	Stud Size (mm)	Figure Dimensions (mm)			CA9 Series Crimp Die	CA-800 Series Crimp Die	Pieces Per Reel
					L	W	C			
PMNF1-3R-3K	.5 – 1.5	Red	3.7	M3	19.3	5.8	5.2	CD9-1A	CD-800-1	3000
PMNF1-35R-3K				M3.5	19.3	5.8	5.2			3000
PMNF1-4R-3K				M4	21.9	7.9	6.4			3000
PMNF1-5R-3K				M5	22.4	8.9	6.4			3000
PMNF1-6R-3K				M6	26.7	10.9	9.7			3000
PMNF2-3R-3K				1.5 – 2.5	Blue	4.1	M3			19.4
PMNF2-35R-3K	M3.5	19.4	5.8				5.1	3000		
PMNF2-4R-3K	M4	21.8	7.9				6.5	3000		
PMNF2-5R-3K	M5	22.4	8.9				6.5	3000		
PMNF2-6R-3K	M6	26.5	10.9				9.7	3000		
PMNF6-3R-2K	2.5 – 6.0	Yellow	5.7				M3	24.7	5.8	7.9
PMNF6-35R-2K				M3.5	24.7	5.8	7.9	2000		
PMNF6-4R-2K				M4	25.7	7.9	7.9	2000		
PMNF6-5R-2K				M5	26.4	9.7	7.9	2000		
PMNF6-6R-2K				M6	29.0	10.9	9.7	2000		
PMNF6-8R-2K				M8	30.0	13.2	9.7	2000		

For applicator information, see page D1.143.

A. System Overview

B1. Cable Ties

B2. Cable Accessories

B3. Stainless Steel Ties

C1. Wiring Duct

C2. Surface Raceway

C3. Abrasion Protection

C4. Cable Management

D1. Terminals

D2. Power Connectors

D3. Grounding Connectors

E1. Labeling Systems

E2. Labels

E3. Pre-Printed & Write-On Markers

E4. Permanent Identification

E5. Lockout/Tagout & Safety Solutions

F. Index

A.
System
Overview



Metric Ring Terminals, Vinyl Insulated – Funnel Entry

B1.
Cable Ties

Type PMV-RB

- Continuously molded design provides reliable, consistent performance through the applicator for a high quality termination every time
- Insulation support helps to prevent wire damage in bending applications
- Ring tongue design assures a secure connection in high vibration applications
- Maximum insulation temperature 221°F (105°C)

B2.
Cable
Accessories

B3.
Stainless
Steel Ties



C1.
Wiring
Duct

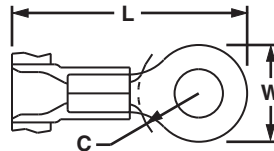

C2.
Surface
Raceway

C3.
Abrasion
Protection

C4.
Cable
Management

D1.
Terminals

D2.
Power
Connectors

D3.
Grounding
Connectors

Part Number	Wire Range (mm ²)	Color Code	Max. Ins.	Stud Size (mm)	Figure Dimensions (mm)			CA9 Series Crimp Die	CA-800 Series Crimp Die	Pieces Per Reel
					L	W	C			
PMV1-3RB-3K	.5 – 1.5	Red	3.7	M3	19.3	5.8	5.2	CD9-1A	CD-800-1	3000
PMV1-35RB-3K				M3.5	19.3	5.8	5.2			3000
PMV1-4RB-3K				M4	21.8	7.9	6.4			3000
PMV1-5RB-3K				M5	22.4	8.9	6.4			3000
PMV1-6RB-3K				M6	26.4	10.9	9.7			3000
PMV2-3RB-3K	1.5 – 2.5	Blue	4.3	M3	21.3	5.8	5.1	CD9-2A	CD-800-2	3000
PMV2-35RB-3K				M3.5	21.3	5.8	5.1			3000
PMV2-4RB-3K				M4	23.9	7.9	6.5			3000
PMV2-5RB-3K				M5	24.4	8.9	6.5			3000
PMV2-6RB-3K				M6	26.7	10.9	9.7			3000
PMV6-3RB-2K	4.0 – 6.0	Yellow	5.7	M3	24.9	6.1	7.9	CD9-3B	CD-800-3	2000
PMV6-35RB-2K				M3.5	24.9	6.1	7.9			2000
PMV6-4RB-2K				M4	25.9	7.9	7.9			2000
PMV6-5RB-2K				M5	26.7	9.4	7.9			2000
PMV6-6RB-2K				M6	29.2	10.9	9.7			2000
PMV6-8RB-2K	M8	30.5	13.2	9.7	2000					

For applicator information, see page D1.143.

E1.
Labeling
Systems

E2.
Labels

E3.
Pre-Printed
& Write-On
Markers

E4.
Permanent
Identification

E5.
Lockout/
Tagout/
& Safety
Solutions

F.
Index



Metric Fork Terminals, Nylon Insulated – Non-Funnel Entry



Type PMN-F

- Continuously molded design provides reliable, consistent performance through the applicator for a high quality termination every time
- Fork design provides for fast and easy installation, without the need to remove fastener

- Metal insulation grip sleeve crimps to wire insulation, providing protection to the crimp joint during high vibration applications
- Internal barrel serrations assure good wire contact and maximum tensile strength

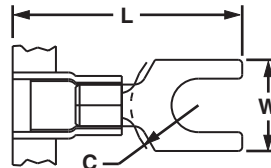

Part Number	Wire Range (mm ²)	Color Code	Max. Ins.	Stud Size (mm)	Figure Dimensions (mm)			CA9 Series Crimp Die	CA-800 Series Crimp Die	Pieces Per Reel
					L	W	C			
PMN1-3F-3K	.5 – 1.5	Red	3.7	M3	19.9	5.9	5.0	CD9-1A	CD-800-1	3000
PMN1-4F-3K				M4	21.6	8.2	5.8			3000
PMN1-5F-3K				M5	21.8	8.9	6.3			3000
PMN1-6F-3K				M6	26.4	11.2	8.4			3000
PMN2-3F-3K	1.5 – 2.5	Blue	4.1	M3	19.8	5.9	5.1	CD9-2A	CD-800-2	3000
PMN2-4F-3K				M4	21.3	7.9	5.9			3000
PMN2-5F-3K				M5	21.9	8.6	6.4			3000
PMN2-6F-3K				M6	26.2	11.2	8.5			3000
PMN6-4F-2K	2.5 – 6.0	Yellow	5.7	M4	25.7	7.9	6.1	CD9-3B	CD-800-3	2000
PMN6-5F-2K				M5	25.7	9.5	6.1			2000
PMN6-6F-2K				M6	28.5	11.0	8.2			2000

For applicator information, see page D1.143.



Metric Fork Terminals, Nylon Insulated – Funnel Entry



Type PMNF-F

- Continuously molded design provides reliable, consistent performance through the applicator for a high quality termination every time
- Flange design provides extra secure connection on a variety of applications

- Metal insulation grip sleeve crimps to wire insulation, providing protection to the crimp joint during high vibration applications
- Internal barrel serrations assure good wire contact and maximum tensile strength

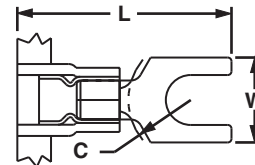

Part Number	Wire Range (mm ²)	Color Code	Max. Ins.	Stud Size (mm)	Figure Dimensions (mm)			CA9 Series Crimp Die	CA-800 Series Crimp Die	Pieces Per Reel
					L	W	C			
PMNF1-3F-3K	.5 – 1.5	Red	3.7	M3	20.0	5.9	5.0	CD9-1A	CD-800-1	3000
PMNF1-4F-3K				M4	21.6	8.2	5.8			3000
PMNF1-5F-3K				M5	21.8	8.9	6.3			3000
PMNF1-6F-3K				M6	26.4	11.2	8.4			3000
PMNF2-3F-3K	1.5 – 2.5	Blue	4.1	M3	19.8	5.9	5.1	CD9-2A	CD-800-2	3000
PMNF2-4F-3K				M4	21.3	7.9	5.9			3000
PMNF2-5F-3K				M5	21.9	8.6	6.4			3000
PMNF2-6F-3K				M6	26.2	11.2	8.5			3000
PMNF6-4F-2K	2.5 – 6.0	Yellow	5.7	M4	25.7	7.9	6.1	CD9-3B	CD-800-3	2000
PMNF6-5F-2K				M5	25.7	9.5	6.1			2000
PMNF6-6F-2K				M6	28.5	11.0	8.2			2000

For applicator information, see page D1.143.

A. System Overview

B1. Cable Ties

B2. Cable Accessories

B3. Stainless Steel Ties

C1. Wiring Duct

C2. Surface Raceway

C3. Abrasion Protection

C4. Cable Management

D1. Terminals

D2. Power Connectors

D3. Grounding Connectors

E1. Labeling Systems

E2. Labels

E3. Pre-Printed & Write-On Markers

E4. Permanent Identification

E5. Lockout/Tagout & Safety Solutions

F. Index

A. System Overview



Metric Fork Terminals, Vinyl Insulated – Funnel Entry

B1. Cable Ties

Type PMV-FB

- Continuously molded design provides reliable, consistent performance through the applicator for a high quality termination every time
- Fork design provides for fast and easy installation, without the need to remove fastener
- Insulation support helps to prevent wire damage in bending applications
- Maximum insulation temperature 221°F (105°C)

B2. Cable Accessories

B3. Stainless Steel Ties

C1. Wiring Duct

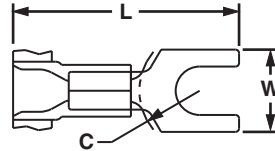

C2. Surface Raceway

C3. Abrasion Protection

C4. Cable Management

D1. Terminals

D2. Power Connectors

D3. Grounding Connectors

E1. Labeling Systems

E2. Labels

E3. Pre-Printed & Write-On Markers

E4. Permanent Identification

E5. Lockout/Tagout & Safety Solutions

F. Index

Part Number	Wire Range (mm ²)	Color Code	Max. Ins.	Stud Size (mm)	Figure Dimensions (mm)			CA9 Series Crimp Die	CA-800 Series Crimp Die	Pieces Per Reel
					L	W	C			
PMV1-3FB-3K	.5 – 1.5	Red	3.7	M3	19.8	5.8	5.1	CD9-1A	CD-800-1	3000
PMV1-4FB-3K				M4	21.3	8.1	5.8			3000
PMV1-5FB-3K				M5	21.8	9.0	6.4			3000
PMV1-6FB-3K				M6	26.2	11.2	8.4			3000
PMV2-3FB-3K	1.5 – 2.5	Blue	4.3	M3	19.8	5.9	5.1	CD9-2A	CD-800-2	3000
PMV2-4FB-3K				M4	21.3	7.9	5.8			3000
PMV2-5FB-3K				M5	21.8	8.6	6.4			3000
PMV2-6FB-3K				M6	26.2	11.2	8.5			3000
PMV6-4FB-2K	2.5 – 6.0	Yellow	5.7	M4	25.9	7.9	6.2	CD9-3B	CD-800-3	2000
PMV6-5FB-2K				M5	25.9	9.7	6.2			2000
PMV6-6FB-2K				M6	28.7	11.0	8.2			2000

For applicator information, see page D1.143.

Features and Benefits – REEL SMART™ Disconnects

SUPRA-GRIP™ Nylon Fully Insulated Funnel Entry, Female Receptacle Type DNG-FB

Available in tab sizes to accommodate .187" or .250" tabs

Fully insulated design provides protection from electrical shorts

Maximum insulation temperature 221°F (105°C)

Fully integrated metal insulation grip for high vibration, high strain relief, and double crimp requirements

Continuously molded design provides reliable, consistent performance through applicator

Funnel entry for faster wire insertion and lower installed cost



UL and CSA Rated up to 600 V per UL 310.

DISCO-LOK™ Nylon Fully Insulated, Funnel Entry, Female Receptacle Type DNG-FL

Available in tab sizes to accommodate .250" tabs

Unique locking mechanism allows for low insertion (mating) and positive locking for secure connections

Maximum insulation temperature 221°F (105°C)

Continuously molded design provides reliable, consistent performance through applicator

Insulation grip sleeve provides a superior insulation crimp for high vibration and high strain relief applications

Funnel entry for faster wire insertion and lower installed cost



UL and CSA rated up to 300 V.

Standard and Premium Nylon Fully Insulated, Funnel Entry, Females Receptacles and Male Tabs Type DNF and DPF

Available in tab sizes to accommodate .110", .187", .205" or .250" tabs

Fully insulated design provides protection from electrical shorts

Maximum insulation temperature 257°F (125°C)

Insulation support restricts excessive wire movement to minimize stress on crimp joint

Continuously molded design provides reliable, consistent performance through applicator

Expanded wire entry (on select sizes) accommodates large insulation or multiple wires

Funnel entry for faster wire insertion and lower installed cost

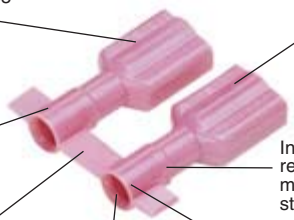

UL and CSA Rated up to 600 V per UL 310.

Vinyl Barrel Insulated Funnel Entry, Female Receptacles and Male Tabs Type DV

Available in tab sizes to accommodate .187", .205", or .250" tabs

Continuously molded design provides reliable, consistent performance through applicator

Insulation grip sleeve provides a superior insulation crimp for high vibration and high strain relief applications

Insulation support to protect electrical crimp



UL and CSA Rated up to 600 V.



High speed electric presses provide for fast terminations. See page D1.144.



Fully Automatic Cable Tie Installation Systems offer an efficient solution for high volume harnessing, assembly, fastening and packaging applications. See pages B1.113 – B1.120.

A. System Overview

B1. Cable Ties

B2. Cable Accessories

B3. Stainless Steel Ties

C1. Wiring Duct

C2. Surface Raceway

C3. Abrasion Protection

C4. Cable Management

D1. Terminals

D2. Power Connectors

D3. Grounding Connectors

E1. Labeling Systems

E2. Labels

E3. Pre-Printed & Write-On Markers

E4. Permanent Identification

E5. Lockout/Tagout & Safety Solutions

F. Index

A. System Overview

Part Number System for REEL SMART™ Disconnects

B1. Cable Ties

D	NF	14	—	250	FIB	3K
Type	Insulation	Wire Range		Size and Type	Special Configuration	Std. Pkg. Size
D = Disconnects	NF = Nylon Funnel Entry NG = Nylon Funnel Entry Metal Insulation Grip NFR = Nylon Funnel Entry Right Angle PF = Premium Grade Nylon (Double Crimp) V = Vinyl	18 = #22 – 18 14 = #16 – 14 10 = #12 – 10		110 = .110 x .032 tab size 111 = .110 x .020 tab size 145 = .145 x .032 tab size 187 = .187 x .032 tab size 188 = .187 x .020 tab size 205 = .187/.205 x .032 tab size 206 = .187/.205 x .020 tab size 250 = .250 x .032 tab size .187/.205: Expandable receptacle will accept male tabs from .187" to .205" widths in .032" or .020" thick styles. Fully reliable connection through all widths.	B = Butted seam C = Compression Tab FB = Metal Insulation Grip, Female FL = Fully Insulated Positive Locking Female FIB = Fully Insulated, Butted Seam, Female FIBX = Fully Insulated, Butted Seam, Female, Expanded Wire Entry FIM = Fully Insulated Male FIMB = Fully Insulated, Male, Oversized Housing FIMX = Fully Insulated, Male, Expanded Wire Entry M = Male MB = Male Butted Seam	K = 1,000 KD = 1,500 2K = 2,000 3K = 3,000

B2. Cable Accessories

B3. Stainless Steel Ties

C1. Wiring Duct

C2. Surface Raceway

C3. Abrasion Protection

C4. Cable Management

D1. Terminals

D2. Power Connectors

D3. Grounding Connectors

E1. Labeling Systems

E2. Labels

E3. Pre-Printed & Write-On Markers

E4. Permanent Identification

E5. Lockout/Tagout & Safety Solutions

F. Index

UL LISTED SUPRA-GRIP™ Female Disconnects, Nylon Fully Insulated – Funnel Entry

Type DNG-FB

- Continuously molded design provides reliable, consistent performance through the applicator for a high quality termination every time
- Disconnect can be inserted and removed from the male tab without the use of tools for lower installed cost
- Flared barrel extension integrated into stamping to provide insulation grip for double crimp requirements
- Internal barrel serrations assure good wire contact and maximum tensile strength
- Internal wire stop assures proper length of insertion into terminal barrel, providing a higher quality connection
- Mates with DNF-FIMB family

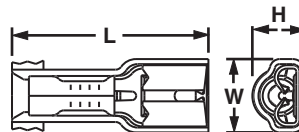

Part Number	Wire Range	Color Code	Max. Ins.	Figure Dimensions (In.)			Tab Size		CA9 Series Crimp Die	CA-800 Series Crimp Die	Pieces Per Reel
				L	W	H	In.	mm			
DNG18-187FB-3K	22 – 18 AWG	Red	.126	.89	.29	.22	.187 x .032	4.8 x .8	CD9-15A	CD-800-15	3000
DNG18-188FB-3K				.89	.29	.22	.187 x .020	4.8 x .5			3000
DNG18-250FB-3K				.93	.35	.23	.250 x .032	6.3 x .8			3000
DNG14-187FB-3K*	16 – 14 AWG	Blue	.153	.89	.29	.25	.187 x .032	4.8 x .8	CD9-16A	CD-800-16	3000
DNG14-188FB-3K				.89	.29	.25	.187 x .020	4.8 x .5			3000
DNG14-250FB-3K				.93	.35	.25	.250 x .032	6.3 x .8			3000

*UL Recognized for copper alloy tabs only.
For applicator information, see page D1.143.

Disco-Lok™ Female Disconnects, Nylon Fully Insulated – Funnel Entry

Type DNG-FL

- Continuously molded design provides reliable, consistent performance through the applicator for a high quality termination every time
- Disconnect can be inserted and removed from the male tab without the use of tools for lower installed cost
- Unique locking mechanism design allows for low insertion forces (mating) and positive lock for high vibration applications where a secure connection is mandatory



- Fully insulated design provides protection from electrical shorts
- Flared barrel extension integrated into stamping to provide insulation grip for double crimp requirements
- Insulation housing moves back and forth to engage and disengage locking mechanism for repeated use
- Specialty tool required to install this disconnect (CT-1014)
- Mates with DNF-FIMB family

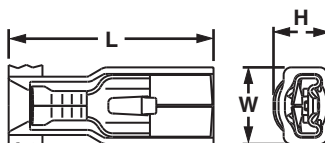

Part Number	Wire Range	Color Code	Max. Ins.	Figure Dimensions (In.)			Tab Size		CA9 Series Crimp Die	CA-800 Series Crimp Die	Pieces Per Reel
				L	W	H	In.	mm			
DNG18-250FL-3K	22 – 18 AWG	Red	.126	.97	.36	.24	.250 x .032	6.3 x .8	CD9-14A	CD-800-14	3000
DNG14-250FL-3K	16 – 14 AWG	Blue	.150	.97	.36	.25	.250 x .032	6.3 x .8	CD9-14A	CD-800-14	3000

For applicator information, see page D1.143.

Female Disconnects, Nylon Fully Insulated – Funnel Entry

Type DNF-FIB

- Continuously molded design provides reliable, consistent performance through the applicator for a high quality termination every time
- Disconnect can be inserted and removed from the male tab without the use of tools for lower installed cost
- Fully insulated design provides protection from electrical shorts



- Disconnects available in common industry tab sizes
- Internal wire stop assures proper length of insertion into terminal barrel, providing a higher quality connection
- UL and CSA rated up to 600 V per UL 310

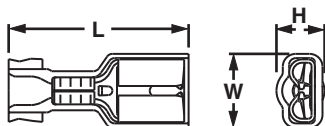

Part Number	Wire Range	Color Code	Max. Ins.	Figure Dimensions (In.)			Tab Size		CA9 Series Crimp Die	CA-800 Series Crimp Die	Pieces Per Reel
				L	W	H	In.	mm			
DNF18-110FIB-3K	22 – 18 AWG	Red	.120	.71	.19	.15	.110 x .032	2.8 x .8	CD9-7A	CD-800-7	3000
DNF18-111FIB-3K		Red	.120	.71	.19	.15	.110 x .020	2.8 x .5	CD9-7A	CD-800-7	3000
DNF18-112FIB-3K*		Natural	.120	.71	.19	.15	.110 x .010	2.8 x .3	CD9-7A	CD-800-7	3000
DNF18-187FIB-3K		Red	.136	.78	.29	.16	.187 x .032	4.8 x .8	CD9-4A	CD-800-4	3000
DNF18-188FIB-3K		Red	.136	.78	.29	.16	.187 x .020	4.8 x .5	CD9-4A	CD-800-4	3000
DNF18-205FIB-3K		Red	.136	.78	.31	.22	.187/.205 x .032	4.8/5.2 x .8	CD9-4A	CD-800-4	3000
DNF18-206FIB-3K		Red	.136	.78	.31	.22	.187/.205 x .020	4.8/5.2 x .5	CD9-4A	CD-800-4	3000
DNF18-250FIB-3K**	Red	.136	.84	.35	.22	.250 x .032	6.3 x .8	CD9-4A	CD-800-4	3000	
DNF14-187FIB-3K	16 – 14 AWG	Blue	.160	.78	.29	.18	.187 x .032	4.8 x .8	CD9-5A	CD-800-5	3000
DNF14-188FIB-3K			.160	.78	.29	.18	.187 x .020	4.8 x .5	CD9-5A	CD-800-5	3000
DNF14-205FIB-3K			.160	.78	.31	.22	.187/.205 x .032	4.8/5.2 x .8	CD9-5A	CD-800-5	3000
DNF14-206FIB-3K			.160	.78	.31	.22	.187/.205 x .020	4.8/5.2 x .5	CD9-5A	CD-800-5	3000
DNF14-250FIB-3K			.160	.84	.35	.22	.250 x .032	6.3 x .8	CD9-5A	CD-800-5	3000
DNF10-250FIB-2K	12 – 10 AWG	Yellow	.220	.96	.35	.23	.250 x .032	6.3 x .8	CD9-13B	CD-800-13	2000
DNF10250FIBC-2K‡			.220	.96	.35	.23	.250 x .032	6.4 x .8	CD9-13B	CD-800-13	2000

*UL/CSA standards do not exist for .110" x .010" receptacles.

**UL with 17 AWG wire.

‡Compressor tab disconnect to fit .250" tabs with a post style support.

For applicator information, see page D1.143.

A. System Overview

B1. Cable Ties

B2. Cable Accessories

B3. Stainless Steel Ties

C1. Wiring Duct

C2. Surface Raceway

C3. Abrasion Protection

C4. Cable Management

D1. Terminals

D2. Power Connectors

D3. Grounding Connectors

E1. Labeling Systems

E2. Labels

E3. Pre-Printed & Write-On Markers

E4. Permanent Identification

E5. Lockout/Tagout & Safety Solutions

F. Index

A. System Overview



Disco™ Female Disconnects, Nylon Fully Insulated – Expanded Wire Entry

Type DNF-FIBX

- Continuously molded design provides reliable, consistent performance through the applicator for a high quality termination every time
- Expanded wire entry designed to accommodate wire with a larger insulation thickness
- Disconnect can be inserted and removed from the male tab without the use of tools for lower installed cost

- Fully insulated design provides protection from electrical shorts
- Disconnects available in common industry tab sizes
- Internal wire stop assures proper length of insertion into terminal barrel, providing a higher quality connection
- UL and CSA rated up to 600 V per UL 310

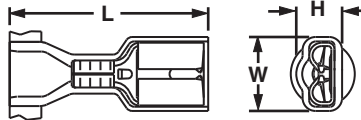

B1. Cable Ties

B2. Cable Accessories

B3. Stainless Steel Ties

C1. Wiring Duct

C2. Surface Raceway

C3. Abrasion Protection

C4. Cable Management

Part Number	Wire Range	Color Code	Max. Ins.	Figure Dimensions (In.)				Tab Size		CA9 Series Crimp Die	CA-800 Series Crimp Die	Pieces Per Reel
				L	W	H	In.	mm				
DNF18205FIBX-2K	22 – 18 AWG	Red	.210	.87	.31	.22	.187/.205 x .032	4.8/5.2 x .8	CD9-6B	CD-800-6	2000	
DNF18206FIBX-2K				.87	.31	.22	.187/.205 x .020	4.8/5.2 x .5			2000	
DNF18250FIBX-2K				.93	.35	.22	.250 x .032	6.3 x .8			2000	
DNF14205FIBX-2K	16 – 14 AWG	Blue	.240	.87	.31	.22	.187/.205 x .032	4.8/5.2 x .8	CD9-8B	CD-800-8	2000	
DNF14206FIBX-2K				.87	.31	.22	.187/.205 x .020	4.8/5.2 x .5			2000	
DNF14250FIBX-2K				.93	.35	.22	.250 x .032	6.3 x .8			2000	

For applicator information, see page D1.143.

D1. Terminals



Disco™ Female Disconnects, Nylon Fully Insulated – Right Angle

Type DNFR-FIB

- Continuously molded design provides reliable, consistent performance through the applicator for a high quality termination every time
- Right angle design for use in limited space applications
- Fully insulated design provides protection from electrical shorts

- Internal wire stop assures proper length of insertion into terminal barrel, providing a higher quality connection
- Disconnect can be inserted and removed from the male tab without the use of tools for lower installed cost
- Disconnects available in common industry tab sizes

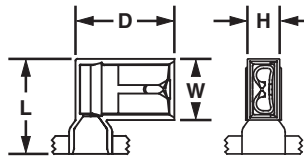

E1. Labeling Systems

E2. Labels

E3. Pre-Printed & Write-On Markers

E4. Permanent Identification

E5. Lockout/Tagout & Safety Solutions

F. Index

Part Number	Wire Range	Color Code	Max. Ins.	Figure Dimensions (In.)				Tab Size		CA9 Series Crimp Die	CA-800 Series Crimp Die	Pieces Per Reel
				L	W	H	D	In.	mm			
DNFR18205FIB-KD	22 – 18 AWG	Red	.178	.57	.37	.21	.60	.187/.205 x .032	4.8/5.2 x .8	CD9-9C	CD-800-9	1500
DNFR18206FIB-KD				.57	.37	.21	.60	.187/.205 x .020	4.8/5.2 x .5			1500
DNFR18250FIB-KD				.57	.37	.21	.60	.250 x .032	6.3 x .8			1500
DNFR14205FIB-KD	16 – 14 AWG	Blue	.178	.57	.37	.21	.60	.187/.205 x .032	4.8/5.2 x .8	CD9-9C	CD-800-9	1500
DNFR14206FIB-KD				.57	.37	.21	.60	.187/.205 x .020	4.8/5.2 x .5			1500
DNFR14250FIB-KD				.57	.37	.21	.60	.250 x .032	6.3 x .8			1500

For applicator information, see page D1.143.



Disco™ Female Disconnects, Vinyl Barrel Insulated – Funnel Entry

Type DV-B

- Continuously molded design provides reliable, consistent performance through the applicator for a high quality termination every time
- Disconnect can be inserted and removed from the male tab without the use of tools for lower installed cost
- Metal insulation grip sleeve crimps to wire insulation, providing protection to the crimp joint during high vibration applications
- Internal barrel serrations assure good wire contact and maximum tensile strength
- Internal wire stop assures proper length of insertion into terminal barrel, providing a higher quality connection
- UL Flammability UL 94V-0, maximum insulation temperature 221°F (105°C)

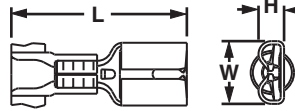

Part Number	Wire Range	Color Code	Max. Ins.	Figure Dimensions (In.)			Tab Size		CA9 Series Crimp Die	CA-800 Series Crimp Die	Pieces Per Reel
				L	W	H	In.	mm			
DV18-187B-3K	22 – 18 AWG	Red	.150	.77	.23	.10	.187 x .032	4.8 x .8	CD9-1A	CD-800-1	3000
DV18-188B-3K			.150	.77	.23	.09	.187 x .020	4.8 x .5			3000
DV18-205B-3K			.150	.77	.25	.12	.187/.205 x .032	4.8/5.2 x .8			3000
DV18-206B-3K			.150	.77	.25	.11	.187/.205 x .020	4.8/5.2 x .5			3000
DV18-250B-3K			.150	.83	.29	.12	.250 x .032	6.3 x .8			3000
DV14-187B-3K	16 – 14 AWG	Blue	.170	.77	.23	.10	.187 x .032	4.8 x .8	CD9-2A	CD-800-2	3000
DV14-188B-3K			.170	.77	.23	.09	.187 x .020	4.8 x .5			3000
DV14-205B-3K			.170	.77	.25	.12	.187/.205 x .032	4.8/5.2 x .8			3000
DV14-206B-3K			.170	.77	.25	.11	.187/.205 x .020	4.5/5.2 x .5			3000
DV14-250B-3K			.170	.83	.29	.12	.250 x .032	6.3 x .8			3000
DV10-250-2K*	12 – 10 AWG	Yellow	.230	.95	.29	.12	.250 x .032	6.3 x .8	CD9-3B	CD-800-3	2000
DV10-250C-2K†**			.230	.95	.29	.12	.250 x .032	6.4 x .8			2000

*Not UL Listed or CSA Certified.

**UL Recognized and CSA Certified.

‡Compression tab disconnect to fit .250" tabs with a post style support.

For applicator information, see page D1.143.

A. System Overview

B1. Cable Ties

B2. Cable Accessories

B3. Stainless Steel Ties

C1. Wiring Duct

C2. Surface Raceway

C3. Abrasion Protection

C4. Cable Management

D1. Terminals

D2. Power Connectors

D3. Grounding Connectors

E1. Labeling Systems

E2. Labels

E3. Pre-Printed & Write-On Markers

E4. Permanent Identification

E5. Lockout/Tagout & Safety Solutions

F. Index

A. System Overview



DISCOGRIP™ Female Disconnects, Fully Insulated

B1. Cable Ties

Type DPF-FIB

- Continuously molded design provides reliable, consistent performance through the applicator for a high quality termination every time
- Disconnect can be inserted and removed from the male tab without the use of tools for lower installed cost
- Premium nylon insulation retains its shape when crimped and provides a tight grip around the wire insulation for maximum strain relief
- Fully insulated design provides protection from electrical shorts
- Internal wire stop assures proper length of insertion into terminal barrel, providing a higher quality connection
- Disconnects available in common industry tab sizes
- UL and CSA rated up to 600 V per UL 310

B2. Cable Accessories

B3. Stainless Steel Ties

C1. Wiring Duct

C2. Surface Raceway

C3. Abrasion Protection

C4. Cable Management

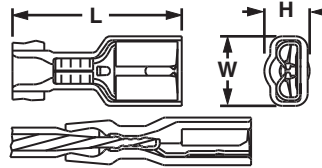

Cross section of DISCOGRIP™ Crimp showing insulation crimp of the wire insulation.

D1. Terminals

D2. Power Connectors

D3. Grounding Connectors

Part Number	Wire Range	Color Code	Max. Ins.	Figure Dimensions (In.)			Tab Size		CA9 Series Crimp Die	CA-800 Series Crimp Die	Pieces Per Reel
				L	W	H	In.	mm			
DPF18-110FIB-3K	22 – 18 AWG	Red	.132	.71	.19	.17	.110 x .032	2.8 x .8	CD9-12A	CD-800-12	3000
DPF18-111FIB-3K			.132	.71	.19	.17	.110 x .020	2.8 x .5			3000
DPF18-187FIB-3K			.136	.78	.29	.16	.187 x .032	4.8 x .8	CD9-10A	CD-800-10	3000
DPF18-188FIB-3K			.136	.78	.29	.16	.187 x .020	4.8 x .5			3000
DPF18-205FIB-3K			.136	.78	.31	.22	.187/.205 x .032	4.8/5.2 x .8			3000
DPF18-206FIB-3K			.136	.78	.31	.22	.187/.205 x .020	4.8/5.2 x .5			3000
DPF18-250FIB-3K	16 – 14 AWG	Blue	.136	.84	.35	.22	.250 x .032	6.3 x .8	CD9-11A	CD-800-11	3000
DPF14-187FIB-3K			.160	.78	.29	.18	.187 x .032	4.8 x .8			3000
DPF14-205FIB-3K			.160	.78	.31	.22	.187/.205 x .032	4.8/5.2 x .8	CD9-13B	CD-800-13	3000
DPF14-206FIB-3K			.160	.78	.31	.22	.187/.205 x .020	4.8/5.2 x .5			3000
DPF14-250FIB-3K			.160	.84	.35	.22	.250 x .032	6.3 x .8	3000		
DPF10-250FIB-2K			12 – 10 AWG	Yellow	.220	.96	.35	.23	.250 x .032	6.3 x .8	

For applicator information, see page D1.143.

E1. Labeling Systems

E2. Labels

E3. Pre-Printed & Write-On Markers

E4. Permanent Identification

E5. Lockout/Tagout & Safety Solutions

F. Index

UL LISTED **SR CERTIFIED** **DISCOGRIP™ Male Disconnects, Fully Insulated**

Type DPF-FIM

- Continuously molded design provides reliable, consistent performance through the applicator for a high quality termination every time
- Disconnect can be inserted and removed from the male tab without the use of tools for lower installed cost
- Fully insulated design provides protection from electrical shorts
- Premium nylon insulation retains its shape when crimped and provides a tight grip around the wire insulation for maximum strain relief

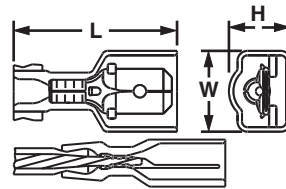

Cross section of DISCOGRIP™ Crimp showing insulation crimp of the wire insulation.

- Oversized housing designed for maximum versatility to mate with most commercially available fully insulated female disconnects
- Internal wire stop assures proper length of insertion into terminal barrel, providing a higher quality connection
- UL and CSA rated up to 600 V per UL 310

Part Number	Wire Range	Color Code	Max. Ins.	Figure Dimensions (In.)			Tab Size		CA9 Series Crimp Die	CA-800 Series Crimp Die	Pieces Per Reel
				L	W	H	In.	mm			
Standard Housing											
DPF18-250FIM-2K	22 – 18 AWG	Red	.133	.90	.41	.29	.250 x .032	6.3 x .8	CD9-10B	CD-800-10	2000
DPF14-250FIM-2K	16 – 14 AWG	Blue	.156						CD9-11B	CD-800-11	2000
Oversized Housing											
DPF18-250FIMB-K*	22 – 18 AWG	Red	.133	.92	.46	.34	.250 x .032	6.3 x .8	CD9-10B	CD-800-10	1000
DPF14-250FIMB-K*	16 – 14 AWG	Blue	.156						CD9-11B	CD-800-11	1000

*To mate with other manufacturers fully insulated .250 x .032 female receptacles. For applicator information, see page D1.143.

A. System Overview

B1. Cable Ties

B2. Cable Accessories

B3. Stainless Steel Ties

C1. Wiring Duct

C2. Surface Raceway

C3. Abrasion Protection

C4. Cable Management

D1. Terminals

D2. Power Connectors

D3. Grounding Connectors

E1. Labeling Systems

E2. Labels

E3. Pre-Printed & Write-On Markers

E4. Permanent Identification

E5. Lockout/Tagout & Safety Solutions

F. Index

A. System Overview



Disco™ Male Disconnects, Nylon Fully Insulated – Funnel Entry

Type DNF-FIM

- Continuously molded design provides reliable, consistent performance through the applicator for a high quality termination every time
- Male tab couples with (all .250 x .032) female disconnects

- Fully insulated design provides protection from electrical shorts
- Male tab can be inserted and removed from the female disconnect without the use of tools for lower installed cost

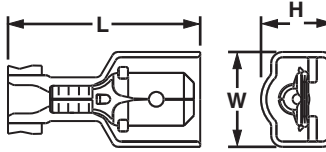

B1. Cable Ties

B2. Cable Accessories

B3. Stainless Steel Ties

C1. Wiring Duct

C2. Surface Raceway

C3. Abrasion Protection

C4. Cable Management

Part Number	Wire Range	Color Code	Max. Ins.	Figure Dimensions (In.)			Tab Size		CA9 Series Crimp Die	CA-800 Series Crimp Die	Pieces Per Reel
				L	W	H	In.	mm			
Standard Housing											
DNF18-250FIM-2K	22 – 18 AWG	Red	.133	.90	.42	.30	.250 x .032	6.3 x .8	CD9-4B	CD-800-4	2000
DNF14-250FIM-2K	16 – 14 AWG	Blue	.158	.90	.42	.30	.250 x .032	6.3 x .8	CD9-5B	CD-800-5	2000
Oversized Housing											
DNF18-250FIMB-K*	22 – 18 AWG	Red	.135	.91	.45	.34	.250 x .032	6.3 x .8	CD9-4B	CD-800-4	1000
DNF14-250FIMB-K*	16 – 14 AWG	Blue	.160	.91	.46	.34	.250 x .032	6.3 x .8	CD9-5B	CD-800-5	1000
DNF10-250FIMB-K	12 – 10 AWG	Yellow	.220	.96	.45	.36	.250 x .032	6.3 x .8	CD9-18B	CD-800-18	1000

*To mate with other manufacturers' fully insulated .250 x .032 female receptacles. For applicator information, see page D1.143.

D1. Terminals



Disco™ Male Disconnects, Nylon Fully Insulated – Expanded Wire Entry

Type DNF-FIMX

- Continuously molded design provides reliable, consistent performance through the applicator for a high quality termination every time
- Expanded wire entry designed to accommodate wire with a larger insulation thickness
- Male tab couples with (all .250 x .032) female disconnects
- Fully insulated design provides protection from electrical shorts

- Male tab can be inserted and removed from the female disconnect without the use of tools for lower installed cost
- Internal barrel serrations assure good wire contact and maximum tensile strength

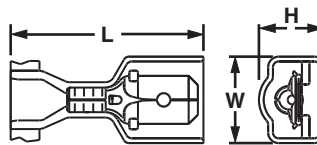

D2. Power Connectors

D3. Grounding Connectors

E1. Labeling Systems

E2. Labels

E3. Pre-Printed & Write-On Markers

E4. Permanent Identification

E5. Lockout/Tagout & Safety Solutions

Part Number	Wire Range	Color Code	Max. Ins.	Figure Dimensions (In.)			Tab Size		CA9 Series Crimp Die	CA-800 Series Crimp Die	Pieces Per Reel
				L	W	H	In.	mm			
DNF18250FIMX-2K*	22 – 18 AWG	Red	.244	.97	.41	.29	.250 x .032	6.3 x .8	CD9-8B	CD-800-8	2000
DNF14250FIMX-2K**	16 – 14 AWG	Blue									2000

*CSA Certified for use with (2) #18 AWG, (2) #20 AWG, or (2) #22 AWG wires.
 **CSA Certified for use with (2) #16 AWG or (2) #18 AWG wires.
 For applicator information, see page D1.143.

F. Index

Disco™ Male Disconnects, Nylon Barrel Insulated – Funnel Entry

CERTIFIED

Type DNF-M

- Continuously molded design provides reliable, consistent performance through the applicator for a high quality termination every time
- Male tab couples with (all .250 x .032) female disconnects
- Male tab can be inserted and removed from the female disconnect without the use of tools for lower installed cost
- Metal insulation grip sleeve crimps to wire insulation, providing protection to the crimp joint during high vibration applications
- Internal barrel serrations assure good wire contact and maximum tensile strength
- Maximum insulation temperature 221°F (105°C)

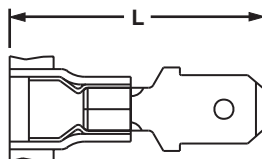

Part Number	Wire Range	Color Code	Max. Ins.	Figure Dimensions (In.)		Tab Size		CA9 Series Crimp Die	CA-800 Series Crimp Die	Pieces Per Reel
				L	In.	mm				
DNF18-250M-3K	22 – 18 AWG	Red	.145	.90	.250 x .032	6.3 x .8	CD9-1A	CD-800-1	3000	
DNF14-250M-3K	16 – 14 AWG	Blue	.162	.90	.250 x .032	6.3 x .8	CD9-2A	CD-800-2	3000	
DNF10-250M-2K*	12 – 10 AWG	Yellow	.225	.95	.250 x .032	6.3 x .8	CD9-3B	CD-800-3	2000	

*Not CSA Certified.

For applicator information, see page D1.143.

Disco™ Male Disconnects, Vinyl Barrel Insulated – Funnel Entry

UL LISTED CERTIFIED

Type DV-MB

- Continuously molded design provides reliable, consistent performance through the applicator for a high quality termination every time
- Male tab couples with (all .250 x .032) female disconnects
- Insulation support helps to prevent wire damage in bending applications
- Male tab can be inserted and removed from the female disconnect without the use of tools for lower installed cost
- UL and CSA rated up to 600 V per UL 310

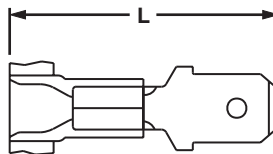

Part Number	Wire Range	Color Code	Max. Ins.	Figure Dimensions (In.)		Tab Size		CA9 Series Crimp Die	CA-800 Series Crimp Die	Pieces Per Reel
				L	In.	mm				
DV18-250MB-3K	22 – 18 AWG	Red	.155	.90	.250 x .032	6.3 x .8	CD9-1A	CD800-1	3000	
DV14-250MB-3K	16 – 14 AWG	Blue	.175				CD9-2A	CD-800-2	3000	
DV10-250M-2K	12 – 10 AWG	Yellow	.225				CD9-3B	CD-800-3	2000	

For applicator information, see page D1.143.

A. System Overview

B1. Cable Ties

B2. Cable Accessories

B3. Stainless Steel Ties

C1. Wiring Duct

C2. Surface Raceway

C3. Abrasion Protection

C4. Cable Management

D1. Terminals

D2. Power Connectors

D3. Grounding Connectors

E1. Labeling Systems

E2. Labels

E3. Pre-Printed & Write-On Markers

E4. Permanent Identification

E5. Lockout/Tagout & Safety Solutions

F. Index

A. System Overview

Pin Terminals, Vinyl Insulated – Funnel Entry

Type PV-PB

B1. Cable Ties

- Continuously molded design provides reliable, consistent performance through the applicator for a high quality termination every time
- Solid pin designed to prevent damage to the wire from over tightening, resulting in a reliable electrical connection

B2. Cable Accessories

B3. Stainless Steel Ties



- For use with pin-type terminal blocks
- Insulation support helps to prevent wire damage in bending applications
- UL rated up to 600 V per UL 486

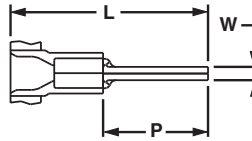

C1. Wiring Duct

Part Number	Wire Range	Color Code	Max. Ins.	Figure Dimensions (In.)			CA9 Series Crimp Die	CA-800 Series Crimp Die	Pieces Per Reel
				L	W	P			
PV18-P47B-3K	22 – 18 AWG	Red	.150	.90	.07	.49	CD9-1A	CD-800-1	3000
PV14-P47B-3K	16 – 14 AWG	Blue	.170	.90	.07	.49	CD9-2A	CD-800-2	3000

For applicator information, see page D1.143.

C2. Surface Raceway

Male Blade Adapters, Vinyl Insulated – Funnel Entry

Type DV-MB

C3. Abrasion Protection

- Continuously molded design provides reliable, consistent performance through the applicator for a high quality termination every time
- Flat blade design to prevent damage to the wire from over tightening, resulting in a reliable electrical connection

C4. Cable Management



- For use with blade-type terminal blocks
- Insulation support helps to prevent wire damage in bending applications
- Brazed seam protects terminal barrel from splitting during the crimp process

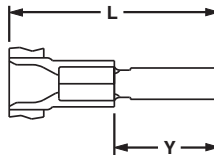

D1. Terminals

Part Number	Wire Range	Color Code	Max. Ins.	Figure Dimensions (In.)		Tab Size (In.)	CA9 Series Crimp Die	CA-800 Series Crimp Die	Pieces Per Reel
				L	Y				
DV18-145MB-3K	22 – 18 AWG	Red	.155	.90	.42	.145 x .032	CD9-1A	CD-800-1	3000
DV14-145MB-3K	16 – 14 AWG	Blue	.175	.90	.42	.145 x .032	CD9-2A	CD-800-2	3000

For applicator information, see page D1.143.

D2. Power Connectors

D3. Grounding Connectors

But Splices Nylon Insulated and Premium Grade Nylon

Type BSN, BSP

E1. Labeling Systems

- Continuously molded design provides reliable, consistent performance through the applicator for a high quality termination every time
- Designed to splice two solid or stranded wires together to repair or lengthen wires
- Butted configuration provides low profile for limited space applications

E2. Labels

E3. Pre-Printed & Write-On Markers



E4. Permanent Identification

- Brazed seam protects terminal barrel from splitting during the crimp process
- Internal wire stop assures proper length of insertion into terminal barrel
- Premium grade nylon insulation available for applications requiring a tighter grip around the wire insulation for maximum strain relief

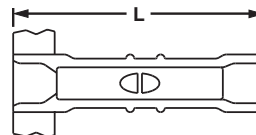

E5. Lockout/Tagout & Safety Solutions

Part Number	Wire Range	Color Code	Max. Ins.	Figure Dimensions (In.)	CA9 Series Crimp Die	CA-800 Series Crimp Die	Pieces Per Reel
				L			
BSN18-3K	22 – 16 AWG	Red	.150	.95	CD9-1A	CD-800-1	3000
BSN14-3K	18 – 14 AWG	Blue	.170	.95	CD9-2A	CD-800-2	3000
BSN10-2K	12 – 10 AWG	Yellow	.230	.95	CD9-17B	CD-800-17	2000
BSP18-3K	22 – 16 AWG	Red	.150	.96	CD9-1A	CD-800-1	3000
BSP14-3K	18 – 14 AWG	Blue	.170	.96	CD9-2A	CD-800-2	3000

For applicator information, see page D1.143.

F. Index

Features and Benefits – REEL SMART™ Metric Disconnects

Metric SUPRA-GRIP™ Nylon Fully Insulated Female Disconnects Type DMNG-FB

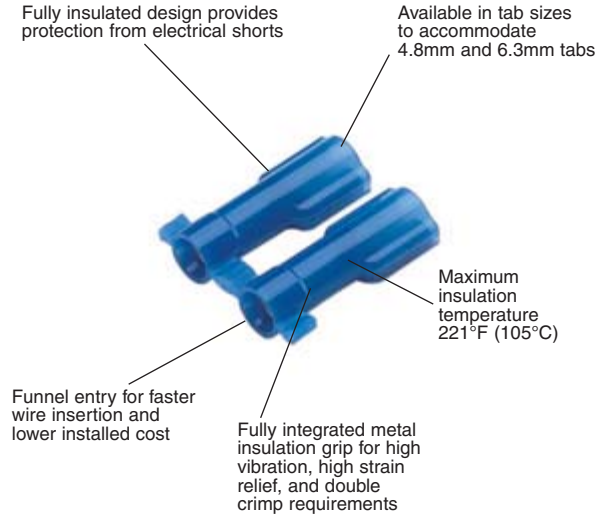

Rated at 600 V.

Metric DISCO-LOK™ Nylon Fully Insulated, Funnel Entry, Female Receptacle Type DMNG-FL

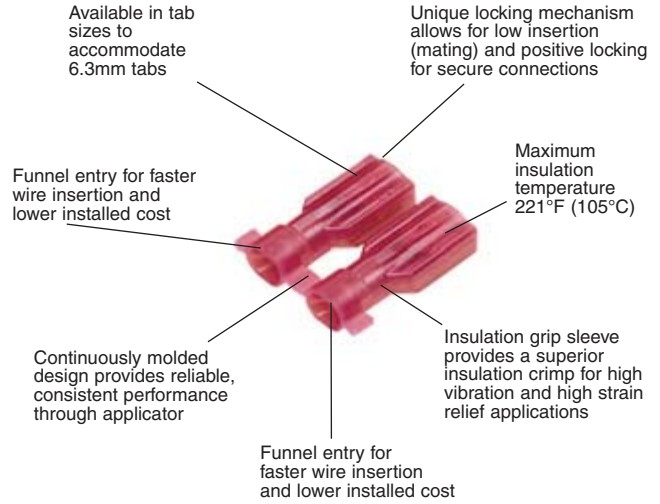

UL and CSA rated up to 300 V.

Metric Standard and Premium Nylon Fully Insulated, Funnel Entry, Female Receptacles and Male Tabs Type DMNF and DMPF

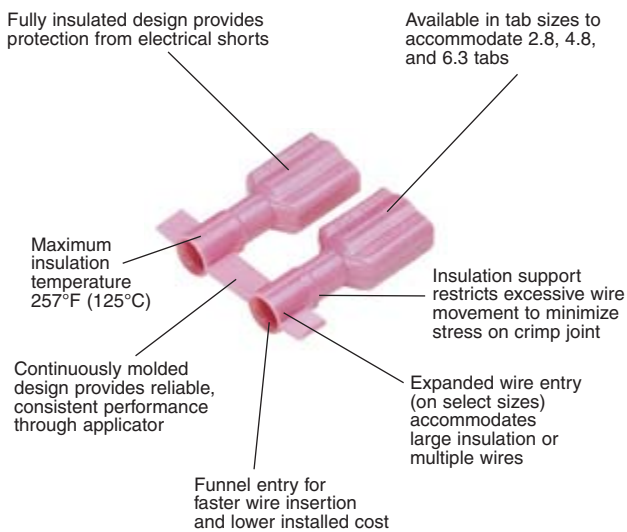

Rated at 600 V.

Metric Vinyl Barrel Insulated Funnel Entry, Female Receptacles and Male Tabs Type DMV

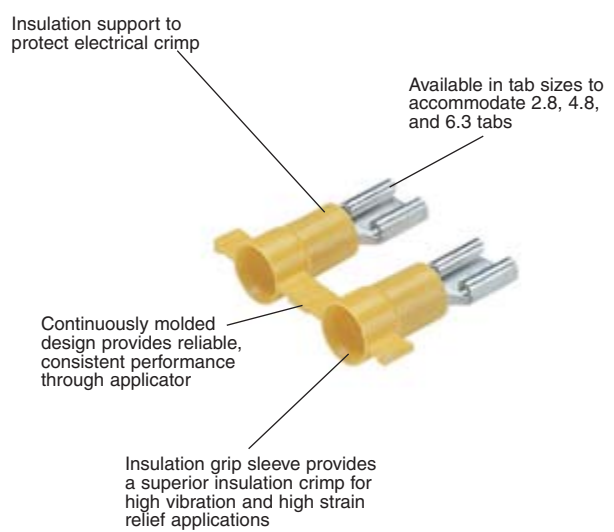

Rated at 600 V.

A. System Overview

B1. Cable Ties

B2. Cable Accessories

B3. Stainless Steel Ties

C1. Wiring Duct

C2. Surface Raceway

C3. Abrasion Protection

C4. Cable Management

D1. Terminals

D2. Power Connectors

D3. Grounding Connectors

E1. Labeling Systems

E2. Labels

E3. Pre-Printed & Write-On Markers

E4. Permanent Identification

E5. Lockout/Tagout & Safety Solutions

F. Index

Part Number System for REEL SMART™ Metric Disconnects

	DM	NF	1	—	285	FIB	3K
	Type	Insulation	Wire Range		Size and Type	Special Configuration	Std. Pkg. Size
A. System Overview	D = Disconnect Metric	N = Nylon NF = Nylon Funnel Entry V = Vinyl	1 = .5 – 1.0mm ² or .5 – 1.5mm ² 2 = 1.5 – 2.5mm ² 6 = 2.5 – 6.0mm ² or 4.0 – 6.0mm ²		283 = 2.8mm x .3mm Tab Size 285 = 2.8mm x .5mm Tab Size 288 = .2.8mm x .8mm Tab Size 485 = 4.8mm x .5mm Tab Size 488 = 4.8mm x .8mm Tab Size 63 = 6.3mm x .8mm Tab Size	B = Butted Seam FB = Metal Insulation Grip, Female FL = Fully Insulated Positive Locking Female FIB = Fully Insulated, Butted Seam, Female FIBX = Fully Insulated, Butted Seam, Female, Expanded Wire Entry FIM = Fully Insulated Male FIMB = Fully Insulated, Male, Oversized Housing FIMX = Fully Insulated, Male, Expanded Wire Entry	K = 1,000 KD = 1,500 2K = 2,000 3K = 3,000
B1. Cable Ties							
B2. Cable Accessories							
B3. Stainless Steel Ties							
C1. Wiring Duct							
C2. Surface Raceway							
C3. Abrasion Protection							
C4. Cable Management						M = Male MB = Male Butted Seam	

NEW!  **Metric SUPRA-GRIP™ Female Disconnects, Nylon Fully Insulated – Funnel Entry**

Type DMNG-FB

- Continuously molded design provides reliable, consistent performance through the applicator for a high quality termination every time
- Disconnect can be inserted and removed from the male tab without the use of tools for lower installed cost
- Flared barrel extension integrated into stamping to provide insulation grip for double crimp requirements
- Internal barrel serrations assure good wire contact and maximum tensile strength
- Internal wire stop assures proper length of insertion into terminal barrel, providing a higher quality connection
- Mates with DNF-FIMB family

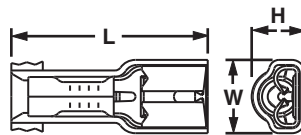

Part Number	Wire Range (mm ²)	Color Code	Max. Ins.	Figure Dimensions (mm)			Tab Size (mm)	CA9 Series Crimp Die	CA-800 Series Crimp Die	Pieces Per Reel
				L	W	H				
DMNG1-485FB-3K	.5 – 1.0	Red	3.2	22.6	7.4	6.1	4.8 x .5	CD9-15A	CD-800-15	3000
DMNG1-488FB-3K			3.2	22.6	7.4	6.1	4.8 x .8			3000
DMNG1-63FB-3K			3.2	23.6	8.9	6.1	6.3 x .8			3000
DMNG2-485FB-3K*	1.5 – 2.5	Blue	3.9	22.6	7.4	6.1	4.8 x .5	CD9-16A	CD-800-16	3000
DMNG2-488FB-3K			3.9	22.6	7.4	6.1	4.8 x .8			3000
DMNG2-63FB-3K			3.9	23.6	8.9	6.1	6.3 x .8			3000

*For #14 AWG wire applications, part to be used with copper alloy tabs only and is UL Recognized. For applicator information, see page D1.143.

Metric *Disco-Lok*™ Female Disconnects, Nylon Fully Insulated – Funnel Entry



Type DMNG-FL

- Continuously molded design provides reliable, consistent performance through the applicator for a high quality termination every time
- Disconnect can be inserted and removed from the male tab without the use of tools for lower installed cost
- Unique locking mechanism design allows for low insertion forces (mating) and positive lock for high vibration applications where a secure connection is mandatory

- Fully insulated design provides protection from electrical shorts
- Flared barrel extension integrated into stamping to provide insulation grip for double crimp requirements
- Insulation housing moves back and forth to engage and disengage locking mechanism for repeated use
- Specialty tool required to install this disconnect (CT-1014)
- Mates with DNF-FIMB family

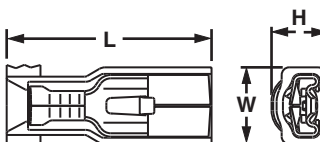

Part Number	Wire Range (mm ²)	Color Code	Max. Ins.	Figure Dimensions (mm)			Tab Size (mm)	CA9 Series Crimp Die	CA-800 Series Crimp Die	Pieces Per Reel
				L	W	H				
DMNG1-63FL-3K	.5 – 1.5	Red	3.2	24.6	9.1	6.1	6.3 x .8	CD9-14A	CD-800-14	3000
DMNG2-63FL-3K	1.5 – 2.5	Blue	3.8	24.6	9.1	6.4	6.3 x .8	CD9-14A	CD-800-14	3000

For applicator information, see page D1.143.



Metric Female Disconnects, Nylon Fully Insulated – Funnel Entry



Type DMNF-FIB

- Continuously molded design provides reliable, consistent performance through the applicator for a high quality termination every time
- Disconnect can be inserted and removed from the male tab without the use of tools for lower installed cost

- Fully insulated design provides protection from electrical shorts
- Disconnects available in common industry tab sizes
- Internal wire stop assures proper length of insertion into terminal barrel, providing a higher quality connection

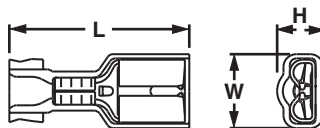

Part Number	Wire Range (mm ²)	Color Code	Max. Ins.	Figure Dimensions (mm)			Tab Size (mm)	CA9 Series Crimp Die	CA-800 Series Crimp Die	Pieces Per Reel	
				L	W	H					
DMNF1-283FIB-3K*	.5 – 1.0	Natural	3.0	18.0	4.8	3.8	2.8 x .3	CD9-7A	CD-800-7	3000	
DMNF1-285FIB-3K			3.0	18.0	4.8	3.8	2.8 x .5			3000	
DMNF1-288FIB-3K			3.0	18.0	4.8	3.8	2.8 x .8			3000	
DMNF1-485FIB-3K			Red	3.4	19.8	7.4	4.1	4.8 x .5	CD9-4A	CD-800-4	3000
DMNF1-488FIB-3K				3.4	19.8	7.4	4.1	4.8 x .8			3000
DMNF1-63FIB-3K				3.4	21.3	8.9	5.6	6.3 x .8			3000
DMNF2-485FIB-3K	1.5 – 2.5	Blue	4.0	19.8	7.4	4.6	4.8 x .5	CD9-5A	CD-800-5	3000	
DMNF2-488FIB-3K			4.0	19.8	7.4	4.6	4.8 x .8			3000	
DMNF2-63FIB-3K			4.1	21.3	8.9	5.6	6.3 x .8			3000	
DMNF6-63FIB-2K			4.0 – 6.0	Yellow	5.6	24.4	8.9			5.8	6.3 x .8

*UL/CSA standards do not exist for 2.8mm x 0.3mm (.110" x .010") receptacles. For applicator information, see page D1.143.

A. System Overview

B1. Cable Ties

B2. Cable Accessories

B3. Stainless Steel Ties

C1. Wiring Duct

C2. Surface Raceway

C3. Abrasion Protection

C4. Cable Management

D1. Terminals

D2. Power Connectors

D3. Grounding Connectors

E1. Labeling Systems

E2. Labels

E3. Pre-Printed & Write-On Markers

E4. Permanent Identification

E5. Lockout/Tagout & Safety Solutions

F. Index

A. System Overview



Metric Disco™ Female Disconnects, Nylon Fully Insulated – Expanded Wire Entry

B1. Cable Ties

Type DMNF-FIBX

- Continuously molded design provides reliable, consistent performance through the applicator for a high quality termination every time
- Expanded wire entry designed to accommodate wire with a larger insulation thickness
- Disconnect can be inserted and removed from the male tab without the use of tools for lower installed cost
- Fully insulated design provides protection from electrical shorts
- Disconnects available in common industry tab sizes
- Internal wire stop assures proper length of insertion into terminal barrel, providing a higher quality connection

B2. Cable Accessories

B3. Stainless Steel Ties

C1. Wiring Duct

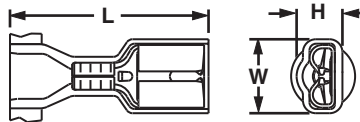

C2. Surface Raceway

C3. Abrasion Protection

C4. Cable Management

Part Number	Wire Range (mm ²)	Color Code	Max. Ins.	Figure Dimensions (mm)			Tab Size (mm)	CA9 Series Crimp Die	CA-800 Series Crimp Die	Pieces Per Reel
				L	W	H				
DMNF1485FIBX-2K	.5 – 1.0	Red	5.3	22.1	7.9	5.5	5.2/4.8 x .5	CD9-6B	CD-800-6	2000
DMNF1488FIBX-2K			5.3	22.1	7.9	5.5	5.2/4.8 x .8			2000
DMNF1-63FIBX-2K			5.3	23.6	8.9	5.5	6.3 x .8			2000
DMNF2485FIBX-2K	1.5 – 2.5	Blue	6.1	22.1	7.9	5.5	5.2/4.8 x .5	CD9-8B	CD-800-8	2000
DMNF2488FIBX-2K			6.1	22.1	7.9	5.5	5.2/4.8 x .8			2000
DMNF2-63FIBX-2K			6.1	23.6	8.9	5.5	6.3 x .8			2000

For applicator information, see page D1.143.

D1. Terminals



Metric Disco™ Female Disconnects, Nylon Fully Insulated – Right Angle

D2. Power Connectors

Type DMNFR-FIB

- Continuously molded design provides reliable, consistent performance through the applicator for a high quality termination every time
- Right angle design for use in limited space applications
- Fully insulated design provides protection from electrical shorts
- Internal wire stop assures proper length of insertion into terminal barrel, providing a higher quality connection
- Disconnect can be inserted and removed from the male tab without the use of tools for lower installed cost
- Disconnects available in common industry tab sizes

D3. Grounding Connectors

E1. Labeling Systems

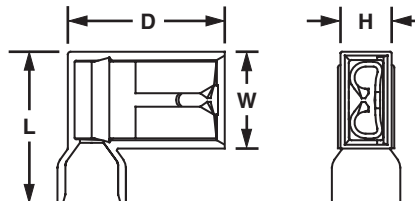

E2. Labels

E3. Pre-Printed & Write-On Markers

E4. Permanent Identification

E5. Lockout/Tagout & Safety Solutions

Part Number	Wire Range (mm ²)	Color Code	Max. Ins.	Figure Dimension (mm)				Tab Size (mm)	CA9 Series Crimp Die	CA-800 Series Crimp Die	Pieces Per Reel
				D	L	W	H				
DMNFR1485FIB-KD	.5 – 1.0	Red	4.5	15.2	14.5	9.4	2.8	5.2/4.8 x .5	CD9-9C	CD-800-9	1500
DMNFR1488FIB-KD			4.5	15.2	14.5	9.4	3.1	5.2/4.8 x .8			1500
DMNFR163FIB-KD			4.5	15.2	14.5	9.4	3.1	6.3 x .8			1500
DMNFR2485FIB-KD	1.5 – 2.5	Blue	4.5	15.2	14.5	9.4	2.8	5.2/4.8 x .5	CD9-9C	CD-800-9	1500
DMNFR2488FIB-KD			4.5	15.2	14.5	9.4	3.1	5.2/4.8 x .8			1500
DMNFR263FIB-KD			4.5	15.2	14.5	9.4	3.1	6.3 x .8			1500

For applicator information, see page D1.143.

F. Index



Metric *Disco*™ Female Disconnects, Vinyl Barrel Insulated – Funnel Entry



Type DMV-B

- Continuously molded design provides reliable, consistent performance through the applicator for a high quality termination every time
- Disconnect can be inserted and removed from the male tab without the use of tools for lower installed cost
- Metal insulation grip sleeve crimps to wire insulation, providing protection to the crimp joint during high vibration applications
- Internal barrel serrations assure good wire contact and maximum tensile strength
- Internal wire stop assures proper length of insertion into terminal barrel, providing a higher quality connection

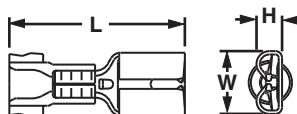

Part Number	Wire Range (mm ²)	Color Code	Max. Ins.	Figure Dimension (mm)			Tab Size (mm)	CA9 Series Crimp Die	CA-800 Series Crimp Die	Pieces Per Reel
				L	W	H				
DMV1-485B-3K	.5 – 1.0	Red	4.06	19.3	5.8	2.5	4.8 x .5	CD9-1A	CD-800-1	3000
DMV1-488B-3K			4.06	18.8	5.8	2.5	4.8 x .8	CD9-2A	CD-800-2	3000
DMV1-63B-3K			4.06	21.1	7.4	3.0	6.3 x .8	CD9-2A	CD-800-2	3000
DMV2-485B-3K	1.5 – 2.5	Blue	4.52	19.6	5.3	2.5	4.8 x .5	CD9-2A	CD-800-2	3000
DMV2-488B-3K			4.52	19.6	5.3	2.5	4.8 x .8	CD9-1A	CD-800-1	3000
DMV2-63B-3K			4.52	21.1	7.4	3.0	6.3 x .8	CD9-2A	CD-800-2	3000
DMV6-63-2K*	4.0 – 6.0	Yellow	5.84	24.1	7.4	3.0	6.3 x .8	CD9-3B	CD-800-8	2000

*Not UL Listed or CSA Certified.
For applicator information, see page D1.143.



Metric *DiscoGRIP*™ Female Disconnects, Fully Insulated – Funnel Entry



Type DMPF-FIB

- Continuously molded design provides reliable, consistent performance through the applicator for a high quality termination every time
- Disconnect can be inserted and removed from the male tab without the use of tools for lower installed cost
- Premium nylon insulation retains its shape when crimped and provides a tight grip around the wire insulation for maximum strain relief
- Fully insulated design provides protection from electrical shorts
- Internal wire stop assures proper length of insertion into terminal barrel, providing a higher quality connection
- Disconnects available in common industry tab sizes

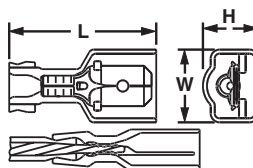

Cross section of *DiscoGRIP*™ Crimp showing insulation crimp of the wire insulation.

Part Number	Wire Range (mm ²)	Color Code	Max. Ins.	Figure Dimensions (mm)			Tab Size (mm)	CA9 Series Crimp Die	CA-800 Series Crimp Die	Pieces Per Reel
				L	W	H				
DMPF1-285FIB-3K	.5 – 1.0	Red	3.4	18.0	4.8	4.3	2.8 x .5	CD9-12A	CD-800-12	3000
DMPF1-288FIB-3K			3.4	18.0	4.8	4.3	2.8 x .8	CD9-12A	CD-800-12	3000
DMPF1-485FIB-3K			3.4	19.8	7.9	4.3	4.8 x .5	CD9-10A	CD-800-10	3000
DMPF1-488FIB-3K	.5 – 1.5	Blue	3.4	19.8	7.9	4.3	4.8 x .8	CD9-10A	CD-800-10	3000
DMPF1-63FIB-3K			3.4	21.3	8.9	5.6	6.3 x .8	CD9-13A	CD-800-13	3000
DMPF2-485FIB-3K			4.0	19.8	7.9	4.8	4.8 x .5	CD9-11A	CD-800-11	3000
DMPF2-488FIB-3K	1.5 – 2.5	Blue	4.0	19.8	7.9	4.8	4.8 x .8	CD9-11A	CD-800-11	3000
DMPF2-63FIB-3K			4.0	21.3	8.9	5.6	6.3 x .8	CD9-11A	CD-800-11	3000
DMPF6-63FIB-2K*	4.0 – 6.0	Yellow	5.5	24.4	8.9	5.8	6.3 x .8	CD9-13A	CD-800-13	2000

*Also approved for use with (2) 1.5 (#16) wires.
For applicator information, see page D1.143.

A. System Overview

B1. Cable Ties

B2. Cable Accessories

B3. Stainless Steel Ties

C1. Wiring Duct

C2. Surface Raceway

C3. Abrasion Protection

C4. Cable Management

D1. Terminals

D2. Power Connectors

D3. Grounding Connectors

E1. Labeling Systems

E2. Labels

E3. Pre-Printed & Write-On Markers

E4. Permanent Identification

E5. Lockout/Tagout & Safety Solutions

F. Index

A. System Overview



Metric *DISCOGRIP*™ Male Disconnects, Fully Insulated – Funnel Entry

B1. Cable Ties

Type DMPF-FIM

- Continuously molded design provides reliable, consistent performance through the applicator for a high quality termination every time
- Disconnect can be inserted and removed from the male tab without the use of tools for lower installed cost
- Fully insulated design provides protection from electrical shorts
- Premium nylon insulation retains its shape when crimped and provides a tight grip around the wire insulation for maximum strain relief

- Oversized housing designed for maximum versatility to mate with most commercially available fully insulated female disconnects
- Internal wire stop assures proper length of insertion into terminal barrel, providing a higher quality connection

B2. Cable Accessories

B3. Stainless Steel Ties

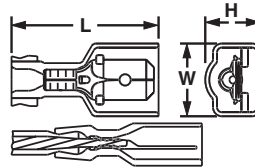

Cross section of *DISCOGRIP*™ Crimp showing insulation crimp of the wire insulation.

C1. Wiring Duct

C2. Surface Raceway

C3. Abrasion Protection

Part Number	Wire Range (mm ²)	Color Code	Max. Ins.	Figure Dimensions (mm)			Tab Size (mm)	CA9 Series Crimp Die	CA-800 Series Crimp Die	Pieces Per Reel
				L	W	H				

Standard Housing

DMPF1-63FIM-2K	.5 – 1.5	Red	3.4	22.9	10.4	7.4	6.3 x .8	CD9-10B	CD-800-10	2000
DMPF2-63FIM-2K	1.5 – 2.5	Blue	4.0	22.9	10.4	7.4	6.3 x .8	CD9-11B	CD-800-11	2000

Oversized Housing

DMPF1-63FIMB-K*	.5 – 1.5	Red	3.4	23.4	11.7	8.6	6.3 x .8	CD9-10B	CD-800-10	1000
DMPF2-63FIMB-K*	1.5 – 2.5	Blue	4.1	23.4	11.7	8.6	6.3 x .8	CD9-11B	CD-800-11	1000

*To mate with other manufacturers' fully insulated .250 x .032 female receptacles. For applicator information, see page D1.143.

C4. Cable Management

D1. Terminals

D2. Power Connectors



Metric *Disco*™ Male Disconnects, Nylon Fully Insulated – Funnel Entry

D3. Grounding Connectors

Type DMNF-FIM

- Continuously molded design provides reliable, consistent performance through the applicator for a high quality termination every time
- Male tab couples with (all .250 x .032) female disconnects
- Fully insulated design provides protection from electrical shorts

- Male tab can be inserted and removed from the female disconnect without the use of tools for lower installed cost
- Internal barrel serrations assure good wire contact and maximum tensile strength

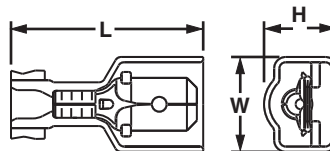

E1. Labeling Systems

E2. Labels

E3. Pre-Printed & Write-On Markers

E4. Permanent Identification

Part Number	Wire Range (mm ²)	Color Code	Max. Ins.	Figure Dimensions (mm)			Tab Size (mm)	CA9 Series Crimp Die	CA-800 Series Crimp Die	Pieces Per Reel
				L	W	H				

Standard Housing

DMNF1-63FIM-2K	.5 – 1.5	Red	3.4	22.9	10.7	7.5	6.3 x .8	CD9-4B	CD-800-4	2000
DMNF2-63FIM-2K	1.5 – 2.5	Blue	4.0	22.9	10.7	7.5	6.3 x .8	CD9-5B	CD-800-5	2000

Oversized Housing

DMNF1-63FIMB-K*	.5 – 1.0	Red	3.4	23.1	11.4	8.6	6.3 x .8	CD9-4B	CD-800-4	1000
DMNF2-63FIMB-K*	1.5 – 2.5	Blue	4.1	23.1	11.7	8.4	6.3 x .8	CD9-5B	CD-800-5	1000

*To mate with other manufacturers' fully insulated .250 x .032 female receptacles. For applicator information, see page D1.143.

E5. Lockout/Tagout & Safety Solutions

F. Index



Metric *Disco*™ Male Disconnects, Nylon Fully Insulated – Expanded Wire Entry



Type DMNF-FIMX

- Continuously molded design provides reliable, consistent performance through the applicator for a high quality termination every time
- Expanded wire entry designed to accommodate wire with a larger insulation thickness
- Male tab couples with (all .250 x .032) female disconnects

- Fully insulated design provides protection from electrical shorts
- Male tab can be inserted and removed from the female disconnect without the use of tools for lower installed cost
- Internal barrel serrations assure good wire contact and maximum tensile strength

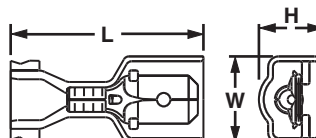

Part Number	Wire Range (mm ²)	Color Code	Max. Ins.	Figure Dimensions (mm)			Tab Size (mm)	CA9 Series Crimp Die	CA-800 Series Crimp Die	Pieces Per Reel
				L	W	H				
DMNF1-63FIMX-2K*	.5 – 1.0	Red	6.2	24.6	10.4	7.4	6.3 x .8	CD9-8B	CD-800-8	2000
DMNF2-63FIMX-2K**	1.5 – 2.5	Blue	6.2	24.6	10.4	7.4	6.3 x .8	CD9-8B	CD-800-8	2000

*CSA Certified for use with (2) #16 AWG or (2) #18 AWG wires.

**CSA Certified for use with (2) #18 AWG, (2) #20 AWG, or (2) #22 AWG wires.

For applicator information, see page D1.143.



Metric *Disco*™ Male Disconnects, Nylon Barrel Insulated – Funnel Entry



Type DMNF-M

- Continuously molded design provides reliable, consistent performance through the applicator for a high quality termination every time
- Male tab couples with (all .250 x .032) female disconnects
- Male tab can be inserted and removed from the female disconnect without the use of tools for lower installed cost

- Metal insulation grip sleeve crimps to wire insulation, providing protection to the crimp joint during high vibration applications
- Internal barrel serrations assure good wire contact and maximum tensile strength
- Maximum insulation temperature 221°F (105°C)

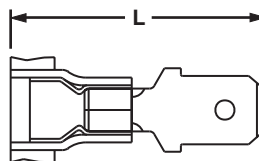

Part Number	Wire Range (mm ²)	Color Code	Max. Ins.	Figure Dimensions (mm)	Tab Size (mm)	CA9 Series Crimp Die	CA-800 Series Crimp Die	Pieces Per Reel
				L				
DMNF1-63M-3K	.5 – 1.0	Red	3.7	22.9	6.3 x .8	CD9-1A	CD-800-1	3000
DMNF2-63M-3K	1.5 – 2.5	Blue	4.1	22.9	6.3 x .8	CD9-2A	CD-800-2	3000
DMNF6-63M-2K*	4.0 – 6.0	Yellow	5.7	24.1	6.3 x .8	CD9-3B	CD-800-3	2000

*Not CSA Certified.

For applicator information, see page D1.143.

A. System Overview

B1. Cable Ties

B2. Cable Accessories

B3. Stainless Steel Ties

C1. Wiring Duct

C2. Surface Raceway

C3. Abrasion Protection

C4. Cable Management

D1. Terminals

D2. Power Connectors

D3. Grounding Connectors

E1. Labeling Systems

E2. Labels

E3. Pre-Printed & Write-On Markers

E4. Permanent Identification

E5. Lockout/Tagout & Safety Solutions

F. Index

A. System Overview



Metric Disco™ Male Disconnects, Vinyl Barrel Insulated – Funnel Entry

B1. Cable Ties

Type DMV-MB

- Continuously molded design provides reliable, consistent performance through the applicator for a high quality termination every time
- Male tab couples with (all .250 x .032) female disconnects
- Insulation support helps to prevent wire damage in bending applications
- Male tab can be inserted and removed from the female disconnect without the use of tools for lower installed cost

B2. Cable Accessories

B3. Stainless Steel Ties

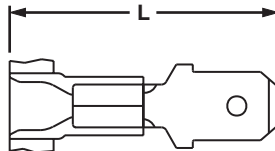

C1. Wiring Duct

C2. Surface Raceway

C3. Abrasion Protection

Part Number	Wire Range (mm ²)	Color Code	Max. Ins.	Figure Dimension (mm)			CA9 Series Crimp Die	CA-800 Series Crimp Die	Pieces Per Reel
				L	Tab Size (mm)				
DMV1-63MB-3K	.5 – 1.5	Red	3.9	22.9	6.3 x .8		CD9-1A	CD-800-1	3000
DMV2-63MB-3K	1.5 – 2.5	Blue	4.5	22.9	6.3 x .8		CD9-2A	CD-800-2	3000
DMV6-63M-2K*	4.0 – 6.0	Yellow	6.1	24.4	6.3 x .8		CD9-3B	CD-800-3	2000

*DMV6-63M-2K is not CSA Certified.
For applicator information, see page D1.143.

C4. Cable Management

D1. Terminals



Metric Pin Terminals, Vinyl Insulated – Funnel Entry

D2. Power Connectors

Type PMV-P

- Continuously molded design provides reliable, consistent performance through the applicator for a high quality termination every time
- Solid pin designed to prevent damage to the wire from over tightening, resulting in a reliable electrical connection
- Insulation support helps to prevent wire damage in bending applications
- For use with pin-type terminal blocks

D3. Grounding Connectors

E1. Labeling Systems

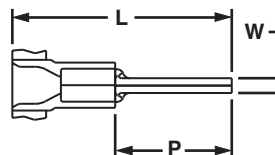

E2. Labels

E3. Pre-Printed & Write-On Markers

Part Number	Wire Range (mm ²)	Color Code	Max. Ins.	Figure Dimensions (mm)			CA9 Series Crimp Die	CA-800 Series Crimp Die	Pieces Per Reel
				L	W	P			
PMV1-P12B-3K	.5 – 1.5	Red	3.8	22.6	2.0	10.0	CD9-1A	CD-800-1	3000
PMV2-P12B-3K	1.5 – 2.5	Blue	4.3	22.6	2.0	10.0	CD9-2A	CD-800-2	3000

For applicator information, see page D1.143.

E4. Permanent Identification

E5. Lockout/Tagout & Safety Solutions

F. Index

Metric Male Blade Adapters, Vinyl Insulated – Funnel Entry



Type DMV-MB

- Continuously molded design provides reliable, consistent performance through the applicator for a high quality termination every time
- Flat blade design to prevent damage to the wire from over tightening, resulting in a reliable electrical connection
- For use with blade-type terminal blocks
- Insulation support helps to prevent wire damage in bending applications
- Brazed seam protects terminal barrel from splitting during the crimp process

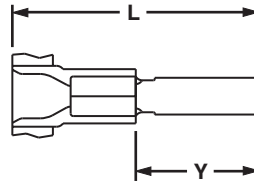

Part Number	Wire Range (mm ²)	Color Code	Max. Ins.	Figure Dimensions (mm)		Tab Size (mm)	CA9 Series Crimp Die	CA-800 Series Crimp Die	Pieces Per Reel
				L	Y				
DMV1-37MB-3K	.5 – 1.5	Red	3.9	22.9	10.5	3.7 x 0.8	CD9-1A	CD-800-1	3000
DMV2-37MB-3K	1.5 – 2.5	Blue	4.5	22.9	10.5	3.7 x 0.8	CD9-2A	CD-800-2	3000

For applicator information, see page D1.143.

Metric Butt Splices, Nylon Insulated



Type BSMN, BSMP

- One-side machine applied termination replaces manual crimping
- Funnel entry on machine termination side to increase productivity
- Also hand crimped with *PANDUIT* CT-100, CT-1550, or CT-1551 crimping tools
- Barrel locating ribs provide for accurate hand tool placement
- Available with insulation crimp premium grade nylon
- Brazed seam with center wire stop for increased performance and productivity

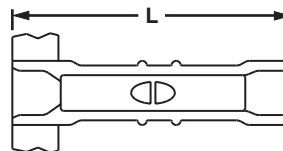

Part Number	Wire Range (mm ²)	Color Code	Max. Ins.	Figure Dimension (mm)	CA9 Series Crimp Die	CA-800 Series Crimp Die	Pieces Per Reel
				L			
BSMN1-3K	.5 – 1.5	Red	3.8	24.1	CD9-1A	CD-800-1	3000
BSMN2-3K	1.5 – 2.5	Blue	4.3	24.1	CD9-2A	CD-800-2	3000
BSMN6-2K	4.0 – 6.0	Yellow	5.8	24.1	CD9-3B	CD-800-3	2000
BSMP1-3K	.5 – 1.5	Red	3.8	24.1	CD9-1A	CD-800-1	3000
BSMP2-3K	1.5 – 2.5	Blue	4.3	24.1	CD9-2A	CD-800-2	3000

For applicator information, see page D1.143.

A. System Overview

B1. Cable Ties

B2. Cable Accessories

B3. Stainless Steel Ties

C1. Wiring Duct

C2. Surface Raceway

C3. Abrasion Protection

C4. Cable Management

D1. Terminals

D2. Power Connectors

D3. Grounding Connectors

E1. Labeling Systems

E2. Labels

E3. Pre-Printed & Write-On Markers

E4. Permanent Identification

E5. Lockout/Tagout & Safety Solutions

F. Index

A.
System
Overview

Features and Benefits – REEL SMART™ Ferrules

B1.
Cable Ties

PANDUIT ferrules are available in strips and reels for wiring applications from #20 – 14 AWG. Offerings include insulated ferrules in single wire configurations. These insulated ferrules are color-coded to DIN standards.

B2.
Cable
Accessories

Insulated Ferrules – Single Wire Type FS and FSD

B3.
Stainless
Steel Ties

Seamless tubular
barrel provides
consistent quality
crimps

Maximum insulation
temperature 192°F (89°C)

C1.
Wiring
Duct



Color-coded polypropylene
identifies wire range

C2.
Surface
Raceway

C3.
Abrasion
Protection

C4.
Cable
Management

Part Number System for REEL SMART® Ferrules

D1.
Terminals

D2.
Power
Connectors

D3.
Grounding
Connectors

F	S	D	75	—	8	5K or DSL	10
Type	Wire Type	Color Code	Wire Size (mm ²)		DIN Length	Std. Pkg. Size	Color-Code Number
F = Ferrule	S = Single	D = DIN = Standard				3K = 3,000 5K = 5,000 DSL = 50	0 = Black 2 = Red 3 = Orange 4 = Yellow 6 = Blue 7 = Light Blue 8 = Gray 10 = White

E1.
Labeling
Systems

E2.
Labels

E3.
Pre-Printed
& Write-On
Markers

E4.
Permanent
Identification

E5.
Lockout/
Tagout/
& Safety
Solutions

F.
Index



Insulated Ferrules on Strips – Single Wire

Type FS

- Polypropylene insulation housing available in DIN standard colors in strips of 50
- Continuously molded design provides consistent placement of ferrules in tool to ensure fast, reliable terminations

- Available in #20 – 14 AWG featuring a seamless barrel design to contain loose wire strands for superior terminations
- Designed for use with the Semiautomatic Ferrule Crimping Tool CT-1000 for medium volume applications

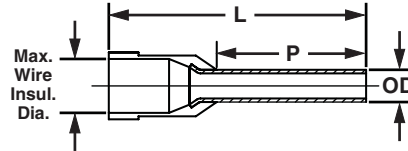
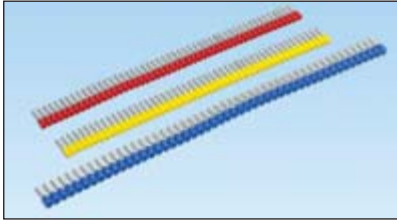

Part Number	Wire Size		Color Code	Max. Wire Insul. Dia.		Figure Dimensions						Wire Strip Length		Recommended Installation Tool	Std. Pkg. Qty.	
	AWG	mm ²		In.	mm	L		P		OD		In.	mm			
DIN End Sleeves																
FSD75-8-DSL10	20 AWG	.50	White	.10	2.6	.60	15.2	.31	8.0	.05	1.4	13/32	10	CT-1000	500	
FSD76-8-DSL8	18 AWG	.75	Gray	.11	2.7	.60	15.2	.31	8.0	.07	1.8	13/32	10		500	
FSD77-8-DSL2		1.00	Red	.12	3.0	.60	15.2	.31	8.0	.08	2.1	13/32	10		500	
FSD78-8-DSL0	16 AWG	1.50	Black	.13	3.2	.60	15.2	.31	8.0	.10	2.6	13/32	10		500	
FSD80-8-DSL6	14 AWG	2.50	Blue	.16	4.0	.60	15.2	.31	8.0	.10	2.6	13/32	10		500	
Additional Colored End Sleeves																
FS75-8-DSL3	20 AWG	.50	Orange	.10	2.6	.60	15.2	.31	8.0	.05	1.4	13/32	10	CT-1000	500	
FS76-8-DSL10	18 AWG	.75	White	.11	2.7	.60	15.2	.31	8.0	.06	1.6	13/32	10		500	
FS76-8-DSL7			Light Blue	.11	2.7	.60	15.2	.31	8.0	.06	1.6	13/32	10		500	
FS77-8-DSL4		1.00	Yellow	.12	3.0	.60	15.2	.31	8.0	.07	1.8	13/32	10		500	
FS78-8-DSL2	16 AWG	1.50	Red	.13	3.2	.60	15.2	.31	8.0	.08	2.1	13/32	10		500	
FS80-8-DSL8	14 AWG	2.50	Gray	.16	4.0	.60	15.2	.31	8.0	.10	2.6	13/32	10		500	

A. System Overview

B1. Cable Ties

B2. Cable Accessories

B3. Stainless Steel Ties

C1. Wiring Duct

C2. Surface Raceway

C3. Abrasion Protection

C4. Cable Management

D1. Terminals

D2. Power Connectors

D3. Grounding Connectors

E1. Labeling Systems

E2. Labels

E3. Pre-Printed & Write-On Markers

E4. Permanent Identification

E5. Lockout/Tagout & Safety Solutions

F. Index

A. System Overview



Semiautomatic Ferrule Crimping Tool – CT-1000

B1. Cable Ties

- Innovative rapid load design utilizes continuously molded ferrules to significantly reduce installation time
- Adjustable die setting allows termination of all *PANDUIT* #20 – 14 AWG continuously molded ferrules with a single tool
- Controlled cycle tool cuts, strips, and crimps wire to maximize efficiency

B2. Cable Accessories



Part Number	Part Description	Std. Pkg. Qty.
CT-1000	Crimps <i>PANDUIT</i> #20 – 14 AWG continuously molded ferrules on strips. Also cuts and strips wire.	1

B3. Stainless Steel Ties

C1. Wiring Duct

C2. Surface Raceway



Insulated Ferrules on Reels – Single Wire

Type FS

C3. Abrasion Protection

- Polypropylene insulation housing available in DIN standard colors in reels of 3000 and 5000
- Continuously molded design provides consistent placement of ferrules in applicator to ensure fast, reliable terminations
- Designed specifically for use with the Ferrule Applicator (CA10) for high volume applications
- Available in #20 – 14 AWG featuring a seamless barrel design to contain loose wire strands for superior terminations

C4. Cable Management

D1. Terminals

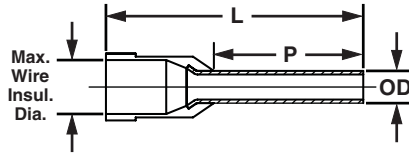

D2. Power Connectors

D3. Grounding Connectors

Part Number	Wire Size		Color Code	Max. Wire Insul. Dia.		Figure Dimensions						Wire Strip Length		CA10 Series Dies	Pieces Per Reel
	AWG	mm ²		In.	mm	L		P		OD		In.	mm		

DIN End Sleeves

FSD75-8-5K10	20 AWG	.50	White	.10	2.6	.57	14.5	.31	8.0	.05	1.4	13/32	10	CD10-1	5000
FSD76-8-5K8	18 AWG	.75	Gray	.11	2.7	.57	14.5	.31	8.0	.06	1.6	13/32	10		5000
FSD77-8-5K2	18 AWG	1.00	Red	.12	3.0	.57	14.5	.31	8.0	.07	1.8	13/32	10	CD10-2	5000
FSD78-8-5K0	16 AWG	1.50	Black	.13	3.2	.57	14.5	.31	8.0	.08	2.1	13/32	10		5000
FSD80-8-3K6	14 AWG	2.50	Blue	.16	4.0	.57	14.5	.31	8.0	.10	2.6	13/32	10	CD10-3	3000

Additional Colored End Sleeves

FS75-8-5K3	20 AWG	.50	Orange	.10	2.6	.57	14.5	.31	8.0	.05	1.4	13/32	10	CD10-1	5000
FS76-8-5K10	18 AWG	.75	White	.11	2.7	.57	14.5	.31	8.0	.06	1.6	13/32	10		5000
FS76-8-5K7	18 AWG	.75	Light Blue	.11	2.7	.57	14.5	.31	8.0	.06	1.6	13/32	10		5000
FS77-8-5K4	18 AWG	1.00	Yellow	.12	3.0	.57	14.5	.31	8.0	.07	1.8	13/32	10	CD10-2	5000
FS78-8-5K2	16 AWG	1.50	Red	.13	3.2	.57	14.5	.31	8.0	.08	2.1	13/32	10		5000
FS80-8-3K8	14 AWG	2.50	Gray	.16	4.0	.57	14.5	.31	8.0	.10	2.6	13/32	10	CD10-3	3000

E1. Labeling Systems

E2. Labels

E3. Pre-Printed & Write-On Markers

E4. Permanent Identification

E5. Lockout/Tagout & Safety Solutions

F. Index



REEL SMART™ Ferrule Applicator – CA10

- Designed for use with continuously molded ferrules in reels of 3,000 or 5,000 for high volume applications
- Precision ferrule indexing through applicator for optimum reliability and productivity
- Universal base plate allows compatibility with the *PANDUIT* CP-871 electric press, and other commercially available bench presses and automatic wire processing (AWP) machines

- Quick change die sets terminate the entire ferrule line to provide fast product change over and reduction in setup time; dies sold separately



Part Number	Part Description	Std. Pkg. Qty.
CA10	Applicator used to terminate entire line of <i>REEL SMART™</i> Continuously Molded Ferrules on reels. For use with CP-871 Electric Press and CD10 series die sets.	1
CD10-1	Die insert to be used with the CA10 applicator to terminate FS75, FSD75, FS76 and FSD76 <i>REEL SMART™</i> Continuously Molded Ferrules.	1
CD10-2	Die insert to be used with the CA10 applicator to terminate FS77, FSD77, FS78 and FSD78 <i>REEL SMART™</i> Continuously Molded Ferrules.	1
CD10-3	Die insert to be used with the CA10 applicator to terminate FS80 and FSD80 <i>REEL SMART™</i> Continuously Molded Ferrules.	1

CA9 EZAIR™ and CA-800EZ Applicators

- Designed to terminate all continuously molded terminals, disconnects, and splices in reels of 3,000 or 5,000 for high volume applications
- Precision terminal indexing through applicator for optimum reliability and productivity

- Universal base plate allows compatibility with the *PANDUIT* CP-871 electric press, and other commercially available bench presses and automatic wire processing (AWP) machines
- Quick change die sets allow for fast product change over and reduction in setup time; dies sold separately



Part Number	Part Description	Std. Pkg. Qty.
CA-800EZ*	Applicator: runs in the AMP* Model T and K bench presses. True "quick change" applicator — no additional plates are necessary. Slide right into the press for easy changeover. Uses CD-800 series die inserts.	1
CA9	<i>CA9 EZAIR™</i> Applicator: terminates the entire <i>REEL SMART™</i> product line. This greatly reduces set up and maintenance time and increases productivity. This patented applicator is so smart it automatically adjusts feed stroke to the correct pitch and length for the entire product line. Crimp die changeover in less than 1 minute, minimizes downtime and increases productivity. Fast, easy loading of terminal parts without special instructions or setup personnel. Simply feed the parts strip into the applicator. All the necessary adjustments are made by the dies and the automatic feed stroke. Used in CP-871 electric press. Safety lockout guard ensures operator safety. Positive stop adjustment rings allow for electrical and insulation crimp adjustments as desired.	1

*AMP is a registered trademark of Tyco Electronics.
For crimp die information, refer to pages D1.145 and D1.146.

A.
System
Overview

B1.
Cable Ties

B2.
Cable
Accessories

B3.
Stainless
Steel Ties

C1.
Wiring
Duct

C2.
Surface
Raceway

C3.
Abrasion
Protection

C4.
Cable
Management

D1.
Terminals

D2.
Power
Connectors

D3.
Grounding
Connectors

E1.
Labeling
Systems

E2.
Labels

E3.
Pre-Printed
& Write-On
Markers

E4.
Permanent
Identification

E5.
Lockout/
Tagout
& Safety
Solutions

F.
Index

A.
System
Overview



Electric Bench Press

B1.
Cable Ties

- For use with **PANDUIT** Universal Applicators and *REEL SMART™* Continuously Molded Terminals and Ferrules to provide a superior solution for quality, high volume terminations

- Tool crimp height adjustment feature allows user to easily set and maintain desired crimp height for consistent performance

B2.
Cable
Accessories

- CP-871 press has a microprocessor based controller and LCD that displays text messages and cycle count with multi-language capability

- Applicator can be changed without the use of tools to facilitate faster changeover for lower cost of ownership

B3.
Stainless
Steel Ties



C1.
Wiring
Duct

Part Number	Part Description	Std. Pkg. Qty.
CP-871	Electric press: 4000+ terminations per hour. Operates on 110 VAC current/60 Hz, 220 VAC current/50 Hz (field convertible). Overall size (without reel): 13" x 33" x 16". Total weight (without reel): 176 lbs. Includes foot pedal.	1

C2.
Surface
Raceway

C3.
Abrasion
Protection

C4.
Cable
Management

Die Sharpening Kits

- Used to resharpen cutting edges and maintain reliability of CD-800 and CD9 series cutter dies

D1.
Terminals

Part Number	Part Description	Std. Pkg. Qty.
DSF-RS	For use with black oxide cutter dies.	1
DSF-NP	For use with nickel-plated cutter dies.	1

D2.
Power
Connectors

D3.
Grounding
Connectors

E1.
Labeling
Systems

E2.
Labels

E3.
Pre-Printed
& Write-On
Markers

E4.
Permanent
Identification

E5.
Lockout/
Tagout/
& Safety
Solutions

F.
Index

Die Information

Part Number	AWG Wire Range	Color Code	(1) Wire Insulation Strain Relief	Part No. Prefix	60/40 Solder Slug Dia.		Spare Part Number				
					In.	mm	Crimp Die	Cutter Die	Lower Die		
CD-800-1	22 – 18/ 22 – 16/ 22 – 18/ 22 – 16	Red	Plastic Ins. Crimp/ Insulation Support/ Metal Ins. Crimp/ Plastic Ins. Crimp	PV, DV-MB, DV-B/BSN/ PN, PNF, DNF-M/ BSP (Premium Nylon)	.188	4.78	TD13471C06 CD-800 -1	TD13483C02 CD-800 C-1	TD17755B01 CD-1		
CD-800-1D***	22 – 18										
CD-800-2	16 – 14/ 18 – 14/ 16 – 14/ 18 – 14	Blue	Plastic Ins. Crimp/ Insulation Support/ Metal Ins. Crimp/ Plastic Ins. Crimp	PV, DV-MB, DV-B/BSN/ PN, PNF, DNF-M/ BSP (Premium Nylon)					TD13473C05 CD-800 -2	TD13486C03 CD-800 C-2	TD17756B01 C-2
CD-800-2D***	16 – 14										
CD-800-3	12 – 10/ 14 – 10/ 16 – 12/ 16 – 12/ 12 – 10	Yellow	Plastic Ins. Crimp/ Plastic Ins. Crimp/ Metal Ins. Crimp/ Plastic Ins. Crimp/ Metal Ins. Crimp	PV, PV12, DV/ DV-C/PN12/PV12/ DV-M, PN, PNF, DNF-M					TD13475C06 CD-800 -3	TD13489C02 CD-800 C-3	TD17757B01 C-3
CD-800-4	12 – 18	Red	Insulation Support	DNF-FIB, DNF-FIM, DNF-FIMB, DNF-LPB					TD13833C06 CD-800 -4, 10	TD13505C02 CD-800 C-4	TD17758B01 C-4, 10
CD-800-5	16 – 14	Blue	Insulation Support	DNF-FIB, DNF-FIM, DNF-FIMB, DNF-LPB					TD13634C05 CD-800 -5, 11	TD13508C02 CD-800 C-5	TD17759B01 C-5, 11
CD-800-6	22 – 18	Red	Insulation Support	DNF-FIBX			TD13652C04 CD-800 -6	TD13499C02 CD-800 C-6	TD17760B01 C-6		
CD-800-7	22 – 18	Red	Insulation Support	DNF-110FIB, DNF-111FIB, DNF-112FIB	.125	3.18	TD13477C05 CD-800 -7, 12	TD13492C03 CD-800 C-7	TD17761B01 C-7, 12		
CD-800-8	16 – 14/ 22 – 18/ 16 – 14	Blue/ Red/ Blue	Insulation Support	DNF-FIBX/DNF-FIMX/ DNF-FIMX	.188	4.78	TD13481C06 CD-800 -8	TD13502C03 CD-800 C-8	TD17762B01 C-8		
CD-800-9	22 – 14	Red/ Blue	Insulation Support	DNFR-FIB	.125	3.18	TD13479C05 CD-800 -9	TD13495C02 CD-800 C-9	TD17763B01 C-9		
CD-800-10	22 – 18	Red	<i>DISCOGRIP</i> ™ Insulation Crimp	DPF-FIB, DPF-FIM, DPF-FIMB, DPF-LPB	.188	4.78	TD13633C06 CD-800 -4, 10	TD16233C02 CD-800 C-10	TD17758B01 C-4, 10		
CD-800-11	16 – 14	Blue	<i>DISCOGRIP</i> ™ Insulation Crimp	DPF-FIM, DPF-FIMB/ DPF-FIB, DPF-LPB					TD13634C05 CD-800 -5, 10	TD16243C01 CD-800 C-11	TD17759B01 CD-5, 11
CD-800-12	22 – 18	Red	<i>DISCOGRIP</i> ™ Insulation Crimp	DPF-110FIB, DPF-111FIB			.125	3.18	TD13477C05 CD-800 -7, 12	TD16235C02 CD-800 C-12	TD17761B01 C-7, 12
CD-800-13	12 – 10	Yellow	Insulation Support/ <i>DISCOGRIP</i> ™ Insulation Crimp	DNF-FIB/DPF-FIB	.188	4.78	TD19116C03 CD-800 -13	TD19115C05 CD-800 C-13	TD19424B01 C-13		
CD-800-14	22 – 18/ 16 – 14	Red/ Blue	Metal Insulation Crimp	DNG-FL	.125	3.18	TD22943C01 CD-800 -14	TD22944C01 CD-800 C-14	TD22960B01 C-14		
CD-800-15	22 – 18	Red	Metal Insulation Crimp	DNG-FB	.188	4.78	TD22945C01 CD-800 -15	TD22946C01 CD-800 C-15	TD22961B01 C-15		
CD-800-16	16 – 14	Blue	Metal Insulation Crimp	DNG-FB					TD22947C01 CD-800 -16	TD22948C01 CD-800 C-16	TD22962B01 C-16
CD-800-17	12 – 10	Yellow	Insulation Support	BSN					TD23601C01 CD-800-17	TD23600C01 CD-800-17	TD23612B01 CD-800-17
CD-800-18	12 – 10	Yellow	Plastic Insulation Crimp	DNF-FIMB					TD13475C06 CD-800-18	TD23773C01 CD-800-18	TD17757B01 CD-800-18

TA13721A01 = 60/40 Solder Slug with 1/8" (.125) outer diameter.

TA13722A01 = 60/40 Solder Slug with 3/16" (.188) outer diameter.

(1) Insulation Support: Minimum wire insulation strain relief for normal applications.

Plastic and *DISCOGRIP*™ Insulation Crimp: Secondary wire insulation strain relief for high vibration or conductor strain applications.

Metal Insulation Grip: Maximum wire insulation strain relief for high vibration or conductor strain applications.

***Modified lower die for barrel insulated disconnects DV-B series. Available as a complete die set or just lower die assembly.

Table continues on page D1.146.

A. System Overview

Die Information (continued)

Part Number	Color Code	AWG Wire Range	Wire Insulation Strain Relief	Part No. Prefix	60/40 Solder Slug Dia.		Spare Part Number		
					In.	mm	Crimp Die	Cutter Die	Lower Die
CD9-1A	Red	22 – 16/ 22 – 16/ 22 – 18/ 22 – 18	Insulation Support/ Plastic Ins. Crimp/ Plastic Ins. Crimp/ Metal Ins. Grip	BSN/BSP/PV, DV-B,DV-MB/PN, PNF, DNF-M	.188	4.78	TD24129C01	TD24139C01	TD24149C01
CD9-1AD***		22–18	Plastic Insulation Crimp Metal Insulation Grip	PV, DV-B, DV-MB, PN, PNF, DNF-M	.188	4.78			
CD9-1B		22 – 18	Plastic Insulation Crimp	PV-56R, PV-38R	.188	4.78			
CD9-2A	Blue	18 – 14/ 18 – 14/ 16 – 14/ 16 – 14/ 16 – 14	Insulation Support/ Plastic Ins. Crimp/ Insulation Support/ Plastic Ins. Crimp/ Metal Ins. Grip	BSN/BSP/BSN/PV, DV-B, DV-MB/PN, PNF, DNF-M	.188	4.78	TD24130C01	TD24140C01	TD23712C01
CD9-2AD***		16–14	Insulation Support Plastic Insulation Crimp Metal Insulation Grip	BSN, PV, DV-B, DV-MB, PN, PNF, DNF-M	.188	4.78			
CD9-2B		16 – 14	Plastic Insulation Crimp	PV-56R, PV-38R	.188	4.78			
CD9-3B	Yellow	12 – 10/ 12 – 10/ 16 – 12	Plastic Ins. Crimp/ Metal Ins. Grip/ Plastic Ins. Crimp	PV, DV, DV-M/PN, PNF, DNF-M/PV12, PN12	.188	4.78	TD24131C01	TD24141C01	TD23713C01
CD9-4A	Red	22 – 18	Insulation Support	DNF-FIB, DNF-LPB	.188	4.78	TD24132C01	TD24142C01	TD24150C01
CD9-4B		22 – 18	Insulation Support	DNF-FIM, DNF-FIMB	.188	4.78			
CD9-5A	Blue	16 – 14	Insulation Support	DNF-FIB, DNF-LPB	.188	4.78	TD24133C01	TD24143C01	TD24151C01
CD9-5B		16 – 14	Insulation Support	DNF-FIM, DNF-FIMB	.188	4.78			
CD9-6B	Red	22 – 18	Insulation Support	DNF-FIBX	.188	4.78	TD23700C01	TD23683C01	TD23716C01
CD9-7A	Red	22 – 18	Insulation Support	DNF-110/111/112FIB	.125	3.18	TD23701C02	TD23684C01	TD23717C01
CD9-8B	Blue/ Red/ Blue	16 – 14/ 22 – 14	Insulation Support/ Insulation Support	DNF-FIBX/ DNF-FIMX	.188	4.78	TD23702C01	TD23685C01	TD23718C01
CD9-9C	Red/ Blue	22 – 14	Insulation Support	DNFR-FIB	.125	3.18	TD23703C01	TD23686C01	TD23719C01
CD9-10A	Red	22 – 18	<i>DISCOGRIP</i> ™ Insulation Crimp	DPF-FIB, DPF-LPB	.188	4.78	TD24132C01	TD24144C01	TD24150C01
CD9-10B	Red	22 – 18	<i>DISCOGRIP</i> ™ Insulation Crimp	DPF-FIM, DPF-FIMB	.188	4.78			
CD9-11A	Blue	16 – 14	<i>DISCOGRIP</i> ™ Insulation Crimp	DPF-FIB, DPF-LPB	.188	4.78	TD24133C01	TD23688C01	TD24151C01
CD9-11B	Blue	16 – 14	<i>DISCOGRIP</i> ™ Insulation Crimp	DPF-FIM, DPF-FIMB	.188	4.78			
CD9-12A	Red	22 – 18	<i>DISCOGRIP</i> ™ Insulation Crimp	DPF-110FIB, DFP-111FIB	.125	3.18	TD23701C02	TD23689C01	TD23717C01
CD9-13B	Yellow	12 – 10	Insulation Support/ <i>DISCOGRIP</i> ™ Insulation Crimp	DNF-FIB/DPF-FIB	.188	4.78	TD24134C01	TD24145C01	TD24152C01
CD9-14A	Red/ Blue	22 – 18/ 16 – 14	Metal Insulation Grip	DNG-FL	.125	3.18	TD23705C01	TD23691C01	TD23721C01
CD9-15A	Red	22 – 18	Metal Insulation Grip	DNG-FB	.188	4.78	TD24135C01	TD24146C01	TD24153C01
CD9-16A	Blue	16 – 14	Metal Insulation Grip	DNG-FB	.188	4.78	TD24136C01	TD24147C01	TD24154C01
CD9-17B	Yellow	12 – 10	Insulation Support	BSN	.188	4.78	TD24110C01	TD24109C01	TD24111C01 TD24112C01
CD9-18B	Yellow	12 – 10	Insulation Support	DNF-FIMB	.188	4.78	TD24131C01	TD23766C01	TD23713C01
CD10-1	—	20 – 18	Insulation Support	FS75, FSD75, FS76, FSD76	—	—	—	—	—
CD10-2	—	18 – 16	Insulation Support	FS77, FSD77, FS78, FSD78	—	—	—	—	—
CD10-3	—	14	Insulation Support	FS80, FSD80	—	—	—	—	—

TA13721A01 = 60/40 Solder Slug with 1/8" (.125) outer diameter.

TA13722A01 = 60/40 Solder Slug with 3/16" (.188) outer diameter.

(1) Insulation Support: Minimum wire insulation strain relief for normal applications.

Plastic and *DISCOGRIP*™ Insulation Crimp: Secondary wire insulation strain relief for high vibration or conductor strain applications.

Metal Insulation Grip: Maximum wire insulation strain relief for high vibration or conductor strain applications.

***Modified lower die for barrel insulated disconnects DV-B series. Available as a complete die set or just lower die assembly.

CA10, CA9 EZAIR™, CA-800EZ and CA-800 Applicators Wire Processing Machine Manufacturer/Press Compatibility

Manufacturer	Wire Processing Machine with (WPM) or Bench Press Only	CA10	PANDUIT Applicators		
			CA9 EZAIR™	CA-800EZ*	CA-800*
PANDUIT	CP-851 bench press only CP-861 bench press only CP-862 bench press only CP-871 bench press only	A	A ¹ A ¹	A A	A A
AMP	CLS III G with G press (AWP) CLS IV with G press (AWP) CLS IV G plus with G press (AWP) G bench press only CLS II with T press (AWP) CLS III with T press (AWP) T bench press only K bench press only	A A A A	A ¹ A ¹ A ¹ A ¹ A ¹ A ¹ A ³	A A	
ARTOS	CS-600 with AMP G press (AWP) CS-600 with TU7M press (AWP) CS-600 with TU-10 press (AWP) MTX Series 5 with TU-10 press (AWP)	A	A ¹ A ¹ A ¹	A	
GAMMA MECCANICA	T20P-110V bench press only		A ¹		
KODERA	Series C451/C450 (AWP) Series C551/C550 (AWP)	A	A ¹ A ¹		
KOMAX	Gamma 311 with Mecal K300 press (AWP) Gamma 333 with mci 711 press (AWP) Alpha 411 with Mecal PE7 or P107 press (AWP) Alpha 433 with Mecal PE7 or P107 press (AWP) 40T with Mecal PE7 press (AWP) 40T with PANDUIT CP-861 press (AWP) bt711 bench press only	A	A ¹ A ¹ A ¹ A ¹ A ¹	A ² A ² A ⁴	A
MEGOMAT	AMS 3001A / APE 300 press (AWP) Contact (AWP) Primo with MP-3.0 press (AWP)		A ¹ A ¹ A ¹		
MOLEX	EP-20 bench press only TM-2000 bench press only			A A	
SCHLEUNIGER	Crimp center 12 with ACP01 press (AWP) Crimp center 64 (AWP) UC-200 bench press	A A	A ¹ A ¹ A ¹	A	
SHINMAYWA	TR101 (AWP) TRD111 / TR111 (AWP)		A ¹	A A	

A = Compatible with Press.

- Special Requirements:
- *Refer to the specific applicator operation manual for installation instructions.
 - ¹ See specific section of installation manual for details.
 - ² Komax press shim is required to operate CA-800EZ Applicator.
 - ³ Bench press air feed capability is required.
 - ⁴ Remove press wire stripper.

A.
System
Overview

B1.
Cable Ties

B2.
Cable
Accessories

B3.
Stainless
Steel Ties

C1.
Wiring
Duct

C2.
Surface
Raceway

C3.
Abrasion
Protection

C4.
Cable
Management

D1.
Terminals

D2.
Power
Connectors

D3.
Grounding
Connectors

E1.
Labeling
Systems

E2.
Labels

E3.
Pre-Printed
& Write-On
Markers

E4.
Permanent
Identification

E5.
Lockout/
Tagout
& Safety
Solutions

F.
Index

A. System Overview

Performance Requirements

B1. Cable Ties

	Wire Size (AWG)							
	#26	#24	#22	#20	#18	#16	#14	#12

UL 486A (Terminals), UL 310 (Male Blade Adapters)

Test current for max. 50° rise (amps)	3.5	7	9	12	17	18	30	35	50
Min. tensile strength* (lbs.)	3	5	8	13	20	30	50	70	80

B2. Cable Accessories

UL 486C (Splices)

Test current for max. 50°C rise (amps)	5.5	7	9	12	17	18	30	35	50
Min. tensile strength* (lbs.)	3	5	8	10	10	15	25	35	40

B3. Stainless Steel Ties

*Pull-out force of the crimped terminal.

C1. Wiring Duct

C2. Surface Raceway

	Wire Size (AWG)						
	#22	#20	#18	#16	#14	#12	#10

UL 310 (Disconnects)

Continuous test current for max. 30°C rise (amps) (for .187", .205", .250" tab widths)	3	4	7	10	15	20	24
--	---	---	---	----	----	----	----

C3. Abrasion Protection

Continuous test current for max. 30°C rise (amps) (for .110" tab width)	2	3	4	5	Not Applicable		
---	---	---	---	---	----------------	--	--

C4. Cable Management

Min. tensile strength* (lbs.)	8	13	20	30	50	70	80
-------------------------------	---	----	----	----	----	----	----

*Pull-out force of the crimped disconnect.

D1. Terminals

D2. Power Connectors

D3. Grounding Connectors

E1. Labeling Systems

E2. Labels

E3. Pre-Printed & Write-On Markers

E4. Permanent Identification

E5. Lockout/Tagout & Safety Solutions

F. Index

Applicable *PAN-TERM*® products meet or exceed the following test specifications:

- UL 486A (Terminals)
 - UL 486C (Splices)
 - UL 310 (Blade Adapters)
 - CSA C22.2 No. 65 (all designs)
- UL and CSA approved products are shown with the applicable logos in the product section
UL file #E52164, CSA File #LR31212

Applicable *REEL SMART*™ products meet or exceed the following test specifications:

- Listed per Underwriters Laboratories, Inc. Standard UL 310 (Disconnects)
 - Recognized under the Component Recognition Program of Underwriters Laboratories Inc.
 - Certified by Canadian Standards Association (Disconnects)
- UL and CSA listed products are shown with the applicable logos in the product section
UL file #E78526, CSA file #LR31212

NOTES

A.
System
Overview

B1.
Cable Ties

B2.
Cable
Accessories

B3.
Stainless
Steel Ties

C1.
Wiring
Duct

C2.
Surface
Raceway

C3.
Abrasion
Protection

C4.
Cable
Management

D1.
Terminals

D2.
Power
Connectors

D3.
Grounding
Connectors

E1.
Labeling
Systems

E2.
Labels

E3.
Pre-Printed
& Write-On
Markers

E4.
Permanent
Identification

E5.
Lockout/
Tagout/
& Safety
Solutions

F.
Index

A. System Overview

B1. Cable Ties

B2. Cable Accessories

B3. Stainless Steel Ties

C1. Wiring Duct

C2. Surface Raceway

C3. Abrasion Protection

C4. Cable Management

D1. Terminals

D2. Power Connectors

D3. Grounding Connectors

E1. Labeling Systems

E2. Labels

E3. Pre-Printed & Write-On Markers

E4. Permanent Identification

E5. Lockout/Tagout & Safety Solutions

F. Index

Compression Connector Reference Information

Selection Guide

- Provides a quick and easy method to select the proper connector to meet the specific application requirements

Conductor Type

Stud Hole Configuration

Barrel Style

Product Type and Page Number

Product Page

- Includes all necessary information for part identification and selection

Agency Listings

Features and Benefits

Full Color Photo and 2-View Drawing

PANDUIT and Competitor Die Information

Page Reference for PANDUIT and Competitor Installation Tooling and Die Selection Charts

Installation Tooling and Die Selection Chart

- Contains comprehensive tool and die installation information for PANDUIT compression connectors with both PANDUIT and competitor tools

Page Reference to Compression Connector Tools Selection Guide for Detailed Information on PANDUIT Tools

PANDUIT and Competitor Tools

Product Type Listed by Conductor Size

Die Part Number, Color Code, Die Index Number and Number of Crimps for Each Product Type and Tool Combination

PAN-LUG™ COMPRESSION CONNECTORS

PANDUIT® PAN-LUG™ Compression Connectors provide permanent terminations for a variety of power and grounding applications, with innovation, highest reliability, and lowest installed cost. PANDUIT offers the first and only copper compression lugs and splices that meet Network Equipment-Building Systems (NEBS) Level 3 requirements as tested by Telcordia Technologies. NEBS Level 3 assures that product performance is suitable for equipment applications that demand minimal service interruptions over the life span of the equipment.

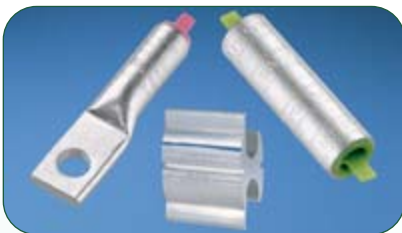

- Functional product information is marked directly on the connector, facilitating the identification, ordering, and usage of the compression connector
- Color-coded to facilitate quick identification of the proper crimping die
- Made from high strength, high conductivity electrolytic copper and aluminum alloy materials to provide optimum connectivity for power and grounding applications
- UL Listed or Recognized, CSA Certified, ABS Type Approved and tested by Telcordia – meets NEBS Level 3, as noted
- Terminations using PANDUIT® PAN-LUG™ Compression Connectors are also UL Listed and CSA Certified with specified competitor tools
- Wide assortment of manual, controlled cycle, battery operated hydraulic and pneumatic crimping tools for reliable connections at the lowest installed cost

PANDUIT® PAN-LUG™ Compression Connectors are designed for use with many different code and flex conductor types and are available in a broad range of styles and sizes including copper one-hole, two-hole, and blank tongue lugs and splices; aluminum one-hole and two-hole lugs and splices; and copper in-line reducing splices. PANDUIT offers a wide assortment of PAN-LUG™ Power Connectors to meet customer needs and today's application requirements.

A.
System
Overview

B1.
Cable Ties

B2.
Cable
Accessories

B3.
Stainless
Steel Ties

C1.
Wiring
Duct

C2.
Surface
Raceway

C3.
Abrasion
Protection

C4.
Cable
Management

D1.
Terminals

D2.
Power
Connectors

D3.
Grounding
Connectors

E1.
Labeling
Systems

E2.
Labels

E3.
Pre-Printed
& Write-On
Markers

E4.
Permanent
Identification

E5.
Lockout/
Tagout
& Safety
Solutions

F.
Index

A. System Overview

Features and Benefits – PAN-LUG™ Compression Connectors

B1. Cable Ties

Bolded features are unique to PANDUIT.

B2. Cable Accessories

B3. Stainless Steel Ties

C1. Wiring Duct

C2. Surface Raceway

C3. Abrasion Protection

C4. Cable Management

D1. Terminals

D2. Power Connectors

D3. Grounding Connectors

E1. Labeling Systems

E2. Labels

E3. Pre-Printed & Write-On Markers

E4. Permanent Identification

E5. Lockout/Tagout & Safety Solutions

F. Index

Copper Lugs

Color-coded bands for proper die selection and crimp placement

Internally beveled barrel end for easy conductor insertion (types LCCF and LCAF available with flared entry for flex conductor)

Inspection windows available to assure complete conductor insertion

Easy-to-read, Color-coded die index numbers for PANDUIT and specified competitor crimping dies for selection

Made from seamless, high conductivity copper tubing and electro tin-plated and burnished to inhibit corrosion

Part number, stud size, and conductor size marked on part for easy identification



Flex Lugs

Inspection window to assure complete conductor insertion

Tin-plated to inhibit corrosion

Color-coded with PANDUIT and specified competitor tools for safe and reliable terminations

Product information marked on part for easy identification

Can be used with code conductor and flex conductor class: G, H, I, K, M and Diesel Locomotive

Narrow Tongues

Inspection window to assure complete conductor insertion

Narrow tongue width for limited space applications

Color-coded with PANDUIT and specified competitor tools for safe and reliable terminations

Tin-plated to inhibit corrosion

Product information marked on part for easy identification

Copper Metric Lugs

Internally beveled barrel ends for easy conductor insertion

Product information marked on part for easy identification

Made from 99.9% pure copper for high quality connection and tin-plated to inhibit corrosion

Inspection window to assure complete conductor insertion



Copper Parallel Splice

Chamfered on both ends for fast and easy conductor insertion

Made from seamless, high conductivity copper tubing and electro tin-plated and burnished to inhibit corrosion

Intuitive part numbering for fast and accurate part selection in the field

Industry recognized color-coding for selection

Large part making in the industry – easier to read in low light conditions



Aluminum Lugs

Color-coded end plugs for proper die selection

Easy-to-read die index numbers for PANDUIT and specified competitor crimping dies for selection

Crimping areas marked on part for proper crimp placement

Part number and conductor size marked on part for easy identification

Made from seamless wrought aluminum and electro tin-plated to inhibit corrosion

Factory pre-filled with oxide inhibitor to prevent oxidation



Compression connector crimping tools speed installation and reduce total installed cost. See pages B3.27 – B3.90.



PANDUIT designs and manufactures a full line of labeling products, software and printers to assist you with your labeling requirements. See pages E1.1 – E2.30.



Heat shrink tubing provides an economical and easy way to insulate, protect, harness and color code electrical and electronic components. See pages C3.16 – C3.39.

Selection Guide – PAN-LUG™ Copper Compression Connectors for Copper Code Conductor

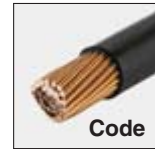

Connector	Barrel Style	Type	Page Number
One-Hole Lugs	Short Barrel with Inspection Window	LCAS	D2.7, D2.8
		LCAS-H 45° bent	D2.9, D2.10
		LCAS-F 90° bent	D2.11, D2.12
	Standard Barrel with Inspection Window	LCA	D2.13, D2.14
		LCA-H 45° bent	D2.15, D2.16
		LCA-F 90° bent	D2.17, D2.18
		LCAN narrow tongue	D2.19, D2.20
		LCA-00 blank tongue	D2.21
	Long Barrel no Inspection Window	LCB	D2.22, D2.23
		LCB-H 45° bent	D2.24, D2.25
		LCB-F 90° bent	D2.26, D2.27
	Long Barrel with Inspection Window	LCBH with corona relief taper	D2.30
		LCB-W	D2.28
		LCB-WH 45° bent	D2.29
	Two-Hole Lugs	Standard Barrel with Inspection Window	LCD
LCD-H 45° bent			D2.33, D2.34
LCD-F 90° bent			D2.35, D2.36
LCDN narrow tongue			D2.37
LCDN-H 45° bent narrow tongue			D2.38
Long Barrel no Inspection Window		LCC	D2.41, D2.42
		LCC-H 45° bent	D2.43, D2.44
		LCC-F 90° bent	D2.45, D2.46
		LCCH with corona relief taper	D2.56
		LCC-00 blank tongue	D2.57
Long Barrel with Inspection Window		LCC-W	D2.47, D2.48, D2.49
		LCC-WH 45° bent	D2.50, D2.51, D2.52
		LCC-WF 90° bent	D2.53, D2.54, D2.55
		LCCN-W narrow tongue	D2.55
		LCC-00W blank tongue	D2.58
Butt Splices	Short Barrel	SCSS	D2.59
	Standard Barrel	SCS	D2.60
	Long Barrel	SCL	D2.61
SCH with corona relief chamfer		D2.62	
T Splices		SCT	D2.63
Parallel Splices		PSC	D2.64
One-Hole Metric Lugs		LCMA	D2.108, D2.109
Two-Hole Metric Lugs		LCMD	D2.110, D2.111
Metric Splices		SCMS	D2.112

- A. System Overview
- B1. Cable Ties
- B2. Cable Accessories
- B3. Stainless Steel Ties
- C1. Wiring Duct
- C2. Surface Raceway
- C3. Abrasion Protection
- C4. Cable Management
- D1. Terminals
- D2. Power Connectors
- D3. Grounding Connectors
- E1. Labeling Systems
- E2. Labels
- E3. Pre-Printed & Write-On Markers
- E4. Permanent Identification
- E5. Lockout/Tagout & Safety Solutions
- F. Index

A. System Overview

B1. Cable Ties

Selection Guide – PAN-LUG™ Copper Compression Connectors for Copper Code and/or Flex Conductor

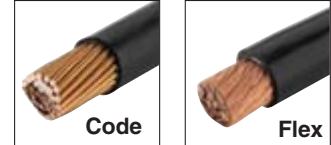

B2. Cable Accessories

B3. Stainless Steel Ties

C1. Wiring Duct

C2. Surface Raceway

C3. Abrasion Protection

C4. Cable Management

D1. Terminals

D2. Power Connectors

D3. Grounding Connectors

E1. Labeling Systems





E2. Labels

E3. Pre-Printed & Write-On Markers









E4. Permanent Identification

E5. Lockout/Tagout & Safety Solutions

F. Index

Connector	Barrel Style	Type	Page Number
	Standard Barrel with Inspection Window Code and Flex	LCAX	D2.66, D2.67
		LCAX-H 45° bent	D2.68, D2.69
		LCAX-F 90° bent	D2.70, D2.71
	Standard Barrel with Inspection Window and Flared Entry Flex	LCAXN narrow tongue	D2.72
		LCAXN-H 45° bent narrow tongue	D2.72
		LCAXN-F 90° bent narrow tongue	D2.73
	Long Barrel with Inspection Window Code and Flex	LCBF	D2.74, D2.75
		LCBF-H 45° bent	D2.76, D2.77
		LCBF-F 90° bent	D2.78, D2.79
	Long Barrel with Inspection Window Code and Flex	LCBX	D2.80
		LCBX-H 45° bent	D2.81
		LCBX-F 90° bent	D2.82
	Standard Barrel with Inspection Window Code and Flex	LCDX	D2.83, D2.84
		LCDX-H 45° bent	D2.85, D2.86
		LCDX-F 90° bent	D2.87, D2.88
	Long Barrel no Inspection Window Flared Entry Flex	LCDXN narrow tongue	D2.89
		LCDXN-H 45° bent narrow tongue	D2.90
		LCDXN-F 90° bent narrow tongue	D2.90
	Long Barrel with Inspection Window Code and Flex	LCCF	D2.97, D2.98
		LCCF-H 45° bent	D2.99, D2.100
		LCCF-F 90° bent	D2.101, D2.102
	Long Barrel with Inspection Window Code and Flex	LCCX	D2.91, D2.92
		LCCX-H 45° bent	D2.93, D2.94
		LCCX-F 90° bent	D2.95, D2.96
	Butt Splices with Flared Entry for Flex	SCSF	D2.103
	Reducing Splices with Inspection Window Code and for Flex	RSCK kits with reducing splice and clear heat shrink	D2.104, D2.105
		RSC reducing splices	D2.106, D2.107

Selection Guide – *PAN-LUG™* Aluminum Compression Connectors for Aluminum or Copper Code Conductor

Connector	Type	Page Number
	One-Hole Lugs	LAA D2.116
	Two-Hole Lugs	LAB D2.117
	Butt Splices	SA D2.119
	Reducing Splices	SAR D2.120
	Bi-Metallic Pin Connectors for Aluminum Conductors Only	BPC D2.121
	HTAP Taps	HTAP D2.122 TAPC black covers for HTAP taps D2.108
	Belleville Washers	CW D2.118, D2.161
	Joint Compounds	CMP D2.123, D2.161

A.
System
Overview

B1.
Cable Ties

B2.
Cable
Accessories

B3.
Stainless
Steel Ties

C1.
Wiring
Duct

C2.
Surface
Raceway

C3.
Abrasion
Protection

C4.
Cable
Management

D1.
Terminals

D2.
Power
Connectors

D3.
Grounding
Connectors

E1.
Labeling
Systems

E2.
Labels

E3.
Pre-Printed
& Write-On
Markers

E4.
Permanent
Identification

E5.
Lockout/
Tagout/
& Safety
Solutions

F.
Index

A. System Overview

Part Number System for Lugs

B1. Cable Ties

B2. Cable Accessories

B3. Stainless Steel Ties

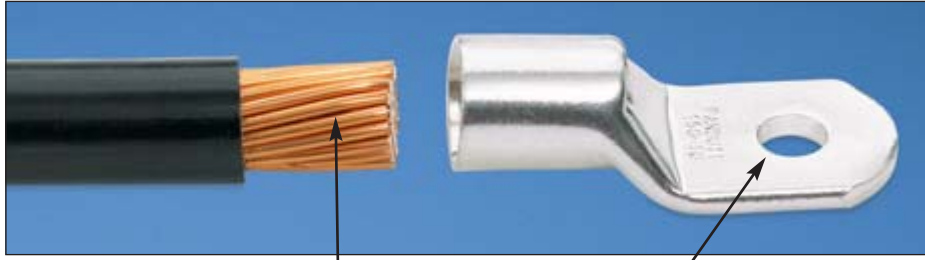

LCD

150
150 = 150mm²

10
10 = 10mmØ

X
1 = 1 X = 10 C = 100
5 = 5 L = 50

C1. Wiring Duct

Part Number System for *PAN-LUG™* Compression AWG Lugs

C2. Surface Raceway

C3. Abrasion Protection

C4. Cable Management

D1. Terminals

D2. Power Connectors

D3. Grounding Connectors

LCD	2/0	—	38	D	F	—	X
Type	Conductor Size		Stud Hole Size	Two Stud Hole Spacing	Tongue Angle		Standard Package Size
Ex: LCD Lug, Copper Two-Hole Standard Barrel			10 = #10	A = .625"	H = 45° Angle		1 = 1
			14 = 1/4"	B = .750"	F = 90° Angle		2 = 2
			56 = 5/16"	C = .875"	No Letter = Straight		3 = 3
			38 = 3/8"	D = 1.0"			5 = 5
			12 = 1/2"	E = 1.25"			6 = 6
			58 = 5/8"	G = 1.5"			X = 10
			34 = 3/4"	J = .5"			E = 20
			78 = 7/8"	K = 2"			Q = 25
			00 = Blank Tongue*	M = 1.375"			L = 50
				P = .688"			
			Q = 1.125"				
			No Letter = 1.75"				

* LCA, LCC and LCD styles only

E1. Labeling Systems

E2. Labels

E3. Pre-Printed & Write-On Markers

E4. Permanent Identification

E5. Lockout/Tagout & Safety Solutions

F. Index



Code Conductor, One-Hole, Short Barrel with Window Lug

For Use with Stranded Copper Conductors

Type LCAS

- Short barrel for limited space applications
- Color-coded barrels marked with *PANDUIT* and specified competitor die index numbers for proper crimp die selection
- Inspection window to visually assure full conductor insertion
- Tin-plated to inhibit corrosion
- UL Listed and CSA Certified to 35 KV** and temperature rated to 90°C when crimped with *PANDUIT* and specified competitor crimping tools and dies
- Tested by Telcordia – meets NEBS Level 3
- American Bureau of Shipping approved

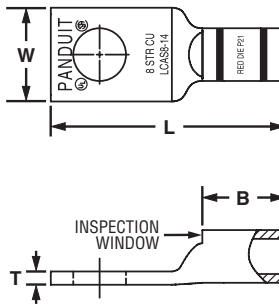

Part Number	Copper Conductor Size	Stud Hole Size (In.)	Figure Dimensions (In.)				PANDUIT Color Code	PANDUIT Die Index No.‡	Burndy Die Index No.‡	T&B Die Index No.‡	Wire Strip Length (In.)	Std. Pkg. Qty.
			W	B	T	L						
LCAS8-10-L	#8 AWG	#10	.41	.42	.08	1.11	Red	P21	49	21	1/2	50
LCAS8-14-L		1/4	.48	.42	.07	1.20	Red	P21	49	21	1/2	50
LCAS8-56-L		5/16	.56	.42	.05	1.32	Red	P21	49	21	1/2	50
LCAS8-38-L		3/8	.60	.42	.05	1.42	Red	P21	49	21	1/2	50
LCAS6-10-L	#6 AWG	#10	.45	.48	.09	1.19	Blue	P24	7	24	9/16	50
LCAS6-14-L		1/4	.48	.48	.08	1.28	Blue	P24	7	24	9/16	50
LCAS6-56-L		5/16	.56	.48	.07	1.40	Blue	P24	7	24	9/16	50
LCAS6-38-L		3/8	.62	.48	.06	1.50	Blue	P24	7	24	9/16	50
LCAS4-10-L	#4 AWG	#10	.55	.53	.09	1.26	Gray	P29	8	29	5/8	50
LCAS4-14-L		1/4	.55	.53	.09	1.35	Gray	P29	8	29	5/8	50
LCAS4-56-L		5/16	.55	.53	.09	1.47	Gray	P29	8	29	5/8	50
LCAS4-38-L		3/8	.62	.53	.07	1.57	Gray	P29	8	29	5/8	50
LCAS2-14-Q	#2 AWG	1/4	.60	.57	.10	1.46	Brown	P33	10	33	5/8	25
LCAS2-56-Q		5/16	.66	.57	.10	1.58	Brown	P33	10	33	5/8	25
LCAS2-38-Q		3/8	.66	.57	.10	1.66	Brown	P33	10	33	5/8	25
LCAS2-12-Q		1/2	.75	.57	.08	1.89	Brown	P33	10	33	5/8	25
LCAS1-14-E	#1 AWG	1/4	.70	.59	.11	1.50	Green	P37	11	37	11/16	20
LCAS1-56-E		5/16	.70	.59	.11	1.63	Green	P37	11	37	11/16	20
LCAS1-38-E		3/8	.70	.59	.11	1.70	Green	P37	11	37	11/16	20
LCAS1-12-E		1/2	.75	.59	.09	1.94	Green	P37	11	37	11/16	20
LCAS1/0-14-X	1/0 AWG	1/4	.76	.66	.12	1.67	Pink	P42	12	42	3/4	10
LCAS1/0-56-X		5/16	.76	.66	.12	1.72	Pink	P42	12	42	3/4	10
LCAS1/0-38-X		3/8	.76	.66	.12	1.80	Pink	P42	12	42	3/4	10
LCAS1/0-12-X		1/2	.80	.66	.12	2.03	Pink	P42	12	42	3/4	10
LCAS2/0-14-X	2/0 AWG	1/4	.85	.72	.13	1.82	Black	P45	13	45	3/4	10
LCAS2/0-56-X		5/16	.85	.72	.13	1.82	Black	P45	13	45	3/4	10
LCAS2/0-38-X		3/8	.85	.72	.13	1.89	Black	P45	13	45	3/4	10
LCAS2/0-12-X		1/2	.85	.72	.13	2.14	Black	P45	13	45	3/4	10

‡See pages D3.52, D3.53 for tool and die information.

**Consult cable manufacturer for voltage stress relief instructions with applications greater than 2000 V.

Table continues on pages D2.8

A. System Overview

B1. Cable Ties

B2. Cable Accessories

B3. Stainless Steel Ties

C1. Wiring Duct

C2. Surface Raceway

C3. Abrasion Protection

C4. Cable Management

D1. Terminals

D2. Power Connectors

D3. Grounding Connectors

E1. Labeling Systems

E2. Labels

E3. Pre-Printed & Write-On Markers

E4. Permanent Identification

E5. Lockout/Tagout & Safety Solutions

F. Index

A.
System
Overview

B1.
Cable Ties

B2.
Cable
Accessories

B3.
Stainless
Steel Ties

C1.
Wiring
Duct

C2.
Surface
Raceway

C3.
Abrasion
Protection

C4.
Cable
Management

D1.
Terminals

D2.
Power
Connectors

D3.
Grounding
Connectors

E1.
Labeling
Systems

E2.
Labels

E3.
Pre-Printed
& Write-On
Markers

E4.
Permanent
Identification

E5.
Lockout/
Tagout/
& Safety
Solutions

F.
Index



Code Conductor, One-Hole, Short Barrel with Window Lug (continued)

Part Number	Copper Conductor Size	Stud Hole Size (In.)	Figure Dimensions (In.)				PANDUIT Color Code	PANDUIT Die Index No.‡	Burndy Die Index No.‡	T&B Die Index No.‡	Wire Strip Length (In.)	Std. Pkg. Qty.
			W	B	T	L						
LCAS3/0-14-X	3/0 AWG	1/4	.96	.83	.13	1.97	Orange	P50	14	50	7/8	10
LCAS3/0-56-X		5/16	.96	.83	.13	1.97	Orange	P50	14	50	7/8	10
LCAS3/0-38-X		3/8	.96	.83	.13	2.03	Orange	P50	14	50	7/8	10
LCAS3/0-12-X		1/2	.96	.83	.13	2.28	Orange	P50	14	50	7/8	10
LCAS4/0-14-X	4/0 AWG	1/4	1.06	.91	.14	2.08	Purple	P54	15	54	1	10
LCAS4/0-56-X		5/16	1.06	.91	.14	2.10	Purple	P54	15	54	1	10
LCAS4/0-38-X		3/8	1.06	.91	.14	2.17	Purple	P54	15	54	1	10
LCAS4/0-12-X		1/2	1.06	.91	.14	2.40	Purple	P54	15	54	1	10
LCAS250-14-X	250 kcmil	1/4	1.17	1.03	.14	2.25	Yellow	P62	16	62	1 1/8	10
LCAS250-56-X		5/16	1.17	1.03	.14	2.25	Yellow	P62	16	62	1 1/8	10
LCAS250-38-X		3/8	1.17	1.03	.14	2.32	Yellow	P62	16	62	1 1/8	10
LCAS250-12-X		1/2	1.17	1.03	.14	2.56	Yellow	P62	16	62	1 1/8	10

‡See pages D3.52, D3.53 for tool and die information.

**Consult cable manufacturer for voltage stress relief instructions with applications greater than 2000 V.



Code Conductor, One-Hole, Short Barrel with Window Lug, 45° Angle

For Use with Stranded Copper Conductors

Type LCAS-H

- Short barrel for limited space applications
- Color-coded barrels marked with *PANDUIT* and specified competitor die index numbers for proper crimp die selection
- Inspection window to visually assure full conductor insertion
- Tin-plated to inhibit corrosion

- UL Listed and CSA Certified to 35 KV** and temperature rated to 90°C when crimped with *PANDUIT* and specified competitor crimping tools and dies
- **Tested by Telcordia – meets NEBS Level 3**
- American Bureau of Shipping approved

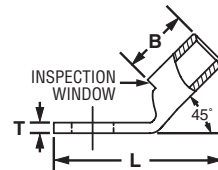
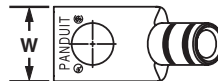

Part Number	Copper Conductor Size	Stud Hole Size (In.)	Figure Dimensions (In.)				PANDUIT Color Code	PANDUIT Die Index No.‡	Burndy Die Index No.‡	T&B Die Index No.‡	Wire Strip Length (In.)	Std. Pkg. Qty.
			W	B	T	L						
LCAS8-10H-L	#8 AWG	#10	.41	.42	.08	1.00	Red	P21	49	21	1/2	50
LCAS8-14H-L		1/4	.48	.42	.07	1.09	Red	P21	49	21	1/2	50
LCAS8-56H-L		5/16	.56	.42	.05	1.20	Red	P21	49	21	1/2	50
LCAS8-38H-L		3/8	.60	.42	.05	1.30	Red	P21	49	21	1/2	50
LCAS6-10H-L	#6 AWG	#10	.45	.48	.09	1.06	Blue	P24	7	24	9/16	50
LCAS6-14H-L		1/4	.48	.48	.08	1.14	Blue	P24	7	24	9/16	50
LCAS6-56H-L		5/16	.56	.48	.07	1.26	Blue	P24	7	24	9/16	50
LCAS6-38H-L		3/8	.62	.48	.06	1.35	Blue	P24	7	24	9/16	50
LCAS4-10H-L	#4 AWG	#10	.55	.53	.09	1.12	Gray	P29	8	29	5/8	50
LCAS4-14H-L		1/4	.55	.53	.09	1.21	Gray	P29	8	29	5/8	50
LCAS4-56H-L		5/16	.55	.53	.09	1.33	Gray	P29	8	29	5/8	50
LCAS4-38H-L		3/8	.62	.53	.07	1.42	Gray	P29	8	29	5/8	50
LCAS2-14H-Q	#2 AWG	1/4	.60	.57	.10	1.27	Brown	P33	10	33	5/8	25
LCAS2-56H-Q		5/16	.66	.57	.10	1.39	Brown	P33	10	33	5/8	25
LCAS2-38H-Q		3/8	.66	.57	.10	1.46	Brown	P33	10	33	5/8	25
LCAS2-12H-Q		1/2	.75	.57	.08	1.68	Brown	P33	10	33	5/8	25
LCAS1-14H-E	#1 AWG	1/4	.70	.59	.11	1.29	Green	P37	11	37	11/16	20
LCAS1-56H-E		5/16	.70	.59	.11	1.42	Green	P37	11	37	11/16	20
LCAS1-38H-E		3/8	.70	.59	.11	1.49	Green	P37	11	37	11/16	20
LCAS1-12H-E		1/2	.75	.59	.09	1.73	Green	P37	11	37	11/16	20
LCAS1/0-14H-X	1/0 AWG	1/4	.76	.66	.12	1.43	Pink	P42	12	42	3/4	10
LCAS1/0-56H-X		5/16	.76	.66	.12	1.49	Pink	P42	12	42	3/4	10
LCAS1/0-38H-X		3/8	.76	.66	.12	1.56	Pink	P42	12	42	3/4	10
LCAS1/0-12H-X		1/2	.80	.66	.12	1.79	Pink	P42	12	42	3/4	10
LCAS2/0-14H-X	2/0 AWG	1/4	.85	.72	.13	1.58	Black	P45	13	45	3/4	10
LCAS2/0-56H-X		5/16	.85	.72	.13	1.58	Black	P45	13	45	3/4	10
LCAS2/0-38H-X		3/8	.85	.72	.13	1.64	Black	P45	13	45	3/4	10
LCAS2/0-12H-X		1/2	.85	.72	.13	1.89	Black	P45	13	45	3/4	10

‡See pages D3.52, D3.53 for tool and die information.

**Consult cable manufacturer for voltage stress relief instructions with applications greater than 2000 V.

Table continues on pages D2.10

A. System Overview

B1. Cable Ties

B2. Cable Accessories

B3. Stainless Steel Ties

C1. Wiring Duct

C2. Surface Raceway

C3. Abrasion Protection

C4. Cable Management

D1. Terminals

D2. Power Connectors

D3. Grounding Connectors

E1. Labeling Systems

E2. Labels

E3. Pre-Printed & Write-On Markers

E4. Permanent Identification

E5. Lockout/Tagout & Safety Solutions

F. Index

A.
System
Overview

B1.
Cable Ties



Code Conductor, One-Hole, Short Barrel with Window Lug, 45° Angle (continued)

B2.
Cable
Accessories

B3.
Stainless
Steel Ties

C1.
Wiring
Duct

C2.
Surface
Raceway

C3.
Abrasion
Protection

C4.
Cable
Management

D1.
Terminals

D2.
Power
Connectors

D3.
Grounding
Connectors

E1.
Labeling
Systems

E2.
Labels

E3.
Pre-Printed
& Write-On
Markers

E4.
Permanent
Identification

E5.
Lockout/
Tagout
& Safety
Solutions

F.
Index

Part Number	Copper Conductor Size	Stud Hole Size (In.)	Figure Dimensions (In.)				PANDUIT Color Code	PANDUIT Die Index No.‡	Burndy Die Index No.‡	T&B Die Index No.‡	Wire Strip Length (In.)	Std. Pkg. Qty.
			W	B	T	L						
LCAS3/0-14H-X	3/0 AWG	1/4	.96	.83	.13	1.68	Orange	P50	14	50	7/8	10
LCAS3/0-56H-X		5/16	.96	.83	.13	1.68	Orange	P50	14	50	7/8	10
LCAS3/0-38H-X		3/8	.96	.83	.13	1.74	Orange	P50	14	50	7/8	10
LCAS3/0-12H-X		1/2	.96	.83	.13	1.99	Orange	P50	14	50	7/8	10
LCAS4/0-14H-X	4/0 AWG	1/4	1.06	.91	.14	1.77	Purple	P54	15	54	1	10
LCAS4/0-56H-X		5/16	1.06	.91	.14	1.78	Purple	P54	15	54	1	10
LCAS4/0-38H-X		3/8	1.06	.91	.14	1.85	Purple	P54	15	54	1	10
LCAS4/0-12H-X		1/2	1.06	.91	.14	2.08	Purple	P54	15	54	1	10
LCAS250-14H-X	250 kcmil	1/4	1.17	1.03	.14	1.89	Yellow	P62	16	62	1 1/8	10
LCAS250-56H-X		5/16	1.17	1.03	.14	1.90	Yellow	P62	16	62	1 1/8	10
LCAS250-38H-X		3/8	1.17	1.03	.14	1.97	Yellow	P62	16	62	1 1/8	10
LCAS250-12H-X		1/2	1.17	1.03	.14	2.20	Yellow	P62	16	62	1 1/8	10

‡See pages D3.52, D3.53 for tool and die information.

**Consult cable manufacturer for voltage stress relief instructions with applications greater than 2000 V.



Code Conductor, One-Hole, Short Barrel with Window Lug, 90° Angle

For Use with Stranded Copper Conductors

Type LCAS-F

- Short barrel for limited space applications
- Color-coded barrels marked with *PANDUIT* and specified competitor die index numbers for proper crimp die selection
- Inspection window to visually assure full conductor insertion
- Tin-plated to inhibit corrosion
- UL Listed and CSA Certified to 35 KV** and temperature rated to 90°C when crimped with *PANDUIT* and specified competitor crimping tools and dies
- Tested by Telcordia – meets NEBS Level 3
- American Bureau of Shipping approved

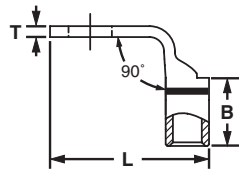
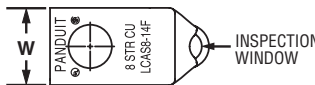

Part Number	Copper Conductor Size	Stud Hole Size (In.)	Figure Dimensions (In.)				PANDUIT Color Code	PANDUIT Die Index No.‡	Burndy Die Index No.‡	T&B Die Index No.‡	Wire Strip Length (In.)	Std. Pkg. Qty.
			W	B	T	L						
LCAS8-10F-L	#8 AWG	#10	.41	.42	.08	.90	Red	P21	49	21	1/2	50
LCAS8-14F-L		1/4	.48	.42	.07	.99	Red	P21	49	21	1/2	50
LCAS8-56F-L		5/16	.56	.42	.05	1.11	Red	P21	49	21	1/2	50
LCAS8-38F-L		3/8	.60	.42	.05	1.21	Red	P21	49	21	1/2	50
LCAS6-10F-L	#6 AWG	#10	.45	.48	.09	.94	Blue	P24	7	24	9/16	50
LCAS6-14F-L		1/4	.48	.48	.08	1.03	Blue	P24	7	24	9/16	50
LCAS6-56F-L		5/16	.56	.48	.07	1.15	Blue	P24	7	24	9/16	50
LCAS6-38F-L		3/8	.62	.48	.06	1.25	Blue	P24	7	24	9/16	50
LCAS4-10F-L	#4 AWG	#10	.55	.53	.09	1.03	Gray	P29	8	29	5/8	50
LCAS4-14F-L		1/4	.55	.53	.09	1.12	Gray	P29	8	29	5/8	50
LCAS4-56F-L		5/16	.55	.53	.09	1.24	Gray	P29	8	29	5/8	50
LCAS4-38F-L		3/8	.62	.53	.07	1.34	Gray	P29	8	29	5/8	50
LCAS2-14F-Q	#2 AWG	1/4	.60	.57	.10	1.24	Brown	P33	10	33	5/8	25
LCAS2-56F-Q		5/16	.66	.57	.10	1.36	Brown	P33	10	33	5/8	25
LCAS2-38F-Q		3/8	.66	.57	.10	1.44	Brown	P33	10	33	5/8	25
LCAS2-12F-Q		1/2	.75	.57	.08	1.67	Brown	P33	10	33	5/8	25
LCAS1-14F-E	#1 AWG	1/4	.70	.59	.11	1.31	Green	P37	11	37	11/16	20
LCAS1-56F-E		5/16	.70	.59	.11	1.44	Green	P37	11	37	11/16	20
LCAS1-38F-E		3/8	.70	.59	.11	1.51	Green	P37	11	37	11/16	20
LCAS1-12F-E		1/2	.75	.59	.09	1.75	Green	P37	11	37	11/16	20
LCAS1/0-14F-X	1/0 AWG	1/4	.76	.66	.12	1.45	Pink	P42	12	42	3/4	10
LCAS1/0-56F-X		5/16	.76	.66	.12	1.51	Pink	P42	12	42	3/4	10
LCAS1/0-38F-X		3/8	.76	.66	.12	1.58	Pink	P42	12	42	3/4	10
LCAS1/0-12F-X		1/2	.80	.66	.12	1.82	Pink	P42	12	42	3/4	10
LCAS2/0-14F-X	2/0 AWG	1/4	.85	.72	.13	1.59	Black	P45	13	45	3/4	10
LCAS2/0-56F-X		5/16	.85	.72	.13	1.59	Black	P45	13	45	3/4	10
LCAS2/0-38F-X		3/8	.85	.72	.13	1.66	Black	P45	13	45	3/4	10
LCAS2/0-12F-X		1/2	.85	.72	.13	1.91	Black	P45	13	45	3/4	10

‡See pages D3.52, D3.53 for tool and die information.

**Consult cable manufacturer for voltage stress relief instructions with applications greater than 2000 V.

Table continues on pages D2.12

- A. System Overview
- B1. Cable Ties
- B2. Cable Accessories
- B3. Stainless Steel Ties
- C1. Wiring Duct
- C2. Surface Raceway
- C3. Abrasion Protection
- C4. Cable Management
- D1. Terminals
- D2. Power Connectors
- D3. Grounding Connectors
- E1. Labeling Systems
- E2. Labels
- E3. Pre-Printed & Write-On Markers
- E4. Permanent Identification
- E5. Lockout/Tagout & Safety Solutions
- F. Index

A.
System
Overview

B1.
Cable Ties



Code Conductor, One-Hole, Short Barrel with Window Lug, 90° Angle (continued)

B2.
Cable
Accessories

B3.
Stainless
Steel Ties

C1.
Wiring
Duct

C2.
Surface
Raceway

C3.
Abrasion
Protection

C4.
Cable
Management

D1.
Terminals

D2.
Power
Connectors

D3.
Grounding
Connectors

E1.
Labeling
Systems

E2.
Labels

E3.
Pre-Printed
& Write-On
Markers

E4.
Permanent
Identification

E5.
Lockout/
Tagout/
& Safety
Solutions

F.
Index

Part Number	Copper Conductor Size	Stud Hole Size (In.)	Figure Dimensions (In.)				PANDUIT Color Code	PANDUIT Die Index No.‡	Burndy Die Index No.‡	T&B Die Index No.‡	Wire Strip Length (In.)	Std. Pkg. Qty.
			W	B	T	L						
LCAS3/0-14F-X	3/0 AWG	1/4	.96	.83	.13	1.67	Orange	P50	14	50	7/8	10
LCAS3/0-56F-X		5/16	.96	.83	.13	1.67	Orange	P50	14	50	7/8	10
LCAS3/0-38F-X		3/8	.96	.83	.13	1.73	Orange	P50	14	50	7/8	10
LCAS3/0-12F-X		1/2	.96	.83	.13	1.98	Orange	P50	14	50	7/8	10
LCAS4/0-14F-X	4/0 AWG	1/4	1.06	.91	.14	1.75	Purple	P54	15	54	1	10
LCAS4/0-56F-X		5/16	1.06	.91	.14	1.77	Purple	P54	15	54	1	10
LCAS4/0-38F-X		3/8	1.06	.91	.14	1.84	Purple	P54	15	54	1	10
LCAS4/0-12F-X		1/2	1.06	.91	.14	2.07	Purple	P54	15	54	1	10
LCAS250-14F-X	250 kcmil	1/4	1.17	1.03	.14	1.82	Yellow	P62	16	62	1 1/8	10
LCAS250-56F-X		5/16	1.17	1.03	.14	1.83	Yellow	P62	16	62	1 1/8	10
LCAS250-38F-X		3/8	1.17	1.03	.14	1.90	Yellow	P62	16	62	1 1/8	10
LCAS250-12F-X		1/2	1.17	1.03	.14	2.13	Yellow	P62	16	62	1 1/8	10

‡See pages D3.52, D3.53 for tool and die information.

**Consult cable manufacturer for voltage stress relief instructions with applications greater than 2000 V.



Code Conductor, One-Hole, Standard Barrel with Window Lug

For Use with Stranded Copper Conductors

Type LCA

- Color-coded barrels marked with *PANDUIT* and specified competitor die index numbers for proper crimp die selection
- Inspection window to visually assure full conductor insertion
- Tin-plated to inhibit corrosion
- UL Listed and CSA Certified to 35 KV** and temperature rated to 90°C when crimped with *PANDUIT* and specified competitor crimping tools and dies

- UL Listed and CSA Certified for wide wire range-taking capability when crimped with *PANDUIT*® *UNI-DIE*™ Dieless Crimping Tools‡
- **Tested by Telcordia – meets NEBS Level 3**
- American Bureau of Shipping Approved

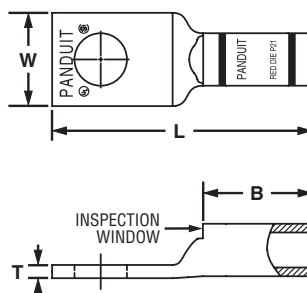

Part Number	Copper Conductor Size	Stud Hole Size (In.)	Figure Dimensions (In.)				PANDUIT Color Code	PANDUIT Die Index No.‡	Burdny Die Index No.‡	T&B Die Index No.‡	Wire Strip Length (In.)	Std. Pkg. Qty.
			W	B	T	L						
LCA10-10-L*	#14 – #10 AWG STR,	#10	.38	.38	.06	1.07	—	—	—	—	7/16	50
LCA10-14-L*	#12 – #10 AWG SOL	1/4	.42	.38	.05	1.16	—	—	—	—	7/16	50
LCA10-56-L*		5/16	.54	.38	.04	1.28	—	—	—	—	7/16	50
LCA10-38-L*		3/8	.56	.38	.04	1.38	—	—	—	—	7/16	50
LCA8-10-L	#8 AWG	#10	.41	.56	.08	1.25	Red	P21	49	21	5/8	50
LCA8-14-L		1/4	.48	.56	.07	1.34	Red	P21	49	21	5/8	50
LCA8-56-L		5/16	.56	.56	.05	1.46	Red	P21	49	21	5/8	50
LCA8-38-L		3/8	.60	.56	.05	1.56	Red	P21	49	21	5/8	50
LCA6-10-L	#6 AWG	#10	.45	.81	.09	1.52	Blue	P24	7	24	7/8	50
LCA6-14-L		1/4	.48	.81	.08	1.61	Blue	P24	7	24	7/8	50
LCA6-56-L		5/16	.56	.81	.07	1.73	Blue	P24	7	24	7/8	50
LCA6-38-L		3/8	.62	.81	.06	1.83	Blue	P24	7	24	7/8	50
LCA4-10-L	#4 – #3 AWG STR,	#10	.55	.81	.09	1.54	Gray	P29	8	29	7/8	50
LCA4-14-L	#2 AWG SOL	1/4	.55	.81	.09	1.63	Gray	P29	8	29	7/8	50
LCA4-56-L		5/16	.55	.81	.09	1.75	Gray	P29	8	29	7/8	50
LCA4-38-L		3/8	.62	.81	.07	1.85	Gray	P29	8	29	7/8	50
LCA2-14-Q	#2 AWG	1/4	.60	.88	.10	1.77	Brown	P33	10	33	15/16	25
LCA2-56-Q		5/16	.66	.88	.10	1.90	Brown	P33	10	33	15/16	25
LCA2-38-Q		3/8	.66	.88	.10	1.97	Brown	P33	10	33	15/16	25
LCA2-12-Q		1/2	.75	.88	.08	2.21	Brown	P33	10	33	15/16	25
LCA1-14-E	#1 AWG	1/4	.70	.88	.11	1.79	Green	P37	11	37	15/16	20
LCA1-56-E		5/16	.70	.88	.11	1.92	Green	P37	11	37	15/16	20
LCA1-38-E		3/8	.70	.88	.11	1.99	Green	P37	11	37	15/16	20
LCA1-12-E		1/2	.75	.88	.09	2.23	Green	P37	11	37	15/16	20

‡See pages D3.54 – D3.57 for tool and die information.

*Not tested to NEBS Level 3 requirements.

**Consult cable manufacturer for voltage stress relief instructions with applications greater than 2000 V.

Table continues on pages D2.14

A. System Overview

B1. Cable Ties

B2. Cable Accessories

B3. Stainless Steel Ties

C1. Wiring Duct

C2. Surface Raceway

C3. Abrasion Protection

C4. Cable Management

D1. Terminals

D2. Power Connectors

D3. Grounding Connectors

E1. Labeling Systems

E2. Labels

E3. Pre-Printed & Write-On Markers

E4. Permanent Identification

E5. Lockout/Tagout & Safety Solutions

F. Index

A.
System
Overview

B1.
Cable Ties

B2.
Cable
Accessories

B3.
Stainless
Steel Ties

C1.
Wiring
Duct

C2.
Surface
Raceway

C3.
Abrasion
Protection

C4.
Cable
Management

D1.
Terminals

D2.
Power
Connectors

D3.
Grounding
Connectors

E1.
Labeling
Systems

E2.
Labels

E3.
Pre-Printed
& Write-On
Markers

E4.
Permanent
Identification

E5.
Lockout/
Tagout
& Safety
Solutions

F.
Index



Code Conductor, One-Hole, Standard Barrel with Window Lug (continued)

Part Number	Copper Conductor Size	Stud Hole Size (In.)	Figure Dimensions (In.)				PANDUIT Color Code	PANDUIT Die Index No.‡	Burndy Die Index No.‡	T&B Die Index No.‡	Wire Strip Length (In.)	Std. Pkg. Qty.
			W	B	T	L						
LCA1/0-14-X	1/0 AWG	1/4	.76	.94	.12	1.95	Pink	P42	12	42	1	10
LCA1/0-56-X		5/16	.76	.94	.12	2.00	Pink	P42	12	42	1	10
LCA1/0-38-X		3/8	.76	.94	.12	2.08	Pink	P42	12	42	1	10
LCA1/0-12-X	2/0 AWG	1/2	.80	.94	.12	2.31	Pink	P42	12	42	1	10
LCA2/0-14-X		1/4	.85	.98	.13	2.09	Black	P45	13	45	1 1/16	10
LCA2/0-56-X		5/16	.85	.98	.13	2.09	Black	P45	13	45	1 1/16	10
LCA2/0-38-X	3/0 AWG	3/8	.85	.98	.13	2.15	Black	P45	13	45	1 1/16	10
LCA2/0-12-X		1/2	.85	.98	.13	2.40	Black	P45	13	45	1 1/16	10
LCA3/0-14-X		1/4	.96	1.14	.13	2.28	Orange	P50	14	50	1 3/16	10
LCA3/0-56-X	4/0 AWG	5/16	.96	1.14	.13	2.28	Orange	P50	14	50	1 3/16	10
LCA3/0-38-X		3/8	.96	1.14	.13	2.34	Orange	P50	14	50	1 3/16	10
LCA3/0-12-X		1/2	.96	1.14	.13	2.59	Orange	P50	14	50	1 3/16	10
LCA4/0-14-X	4/0 AWG	1/4	1.06	1.19	.14	2.36	Purple	P54	15	54	1 1/4	10
LCA4/0-56-X		5/16	1.06	1.19	.14	2.38	Purple	P54	15	54	1 1/4	10
LCA4/0-38-X		3/8	1.06	1.19	.14	2.45	Purple	P54	15	54	1 1/4	10
LCA4/0-12-X	250 kcmil	1/2	1.06	1.19	.14	2.68	Purple	P54	15	54	1 1/4	10
LCA250-14-X		1/4	1.17	1.25	.14	2.47	Yellow	P62	16	62	1 5/16	10
LCA250-56-X		5/16	1.17	1.25	.14	2.48	Yellow	P62	16	62	1 5/16	10
LCA250-38-X	300 kcmil	3/8	1.17	1.25	.14	2.55	Yellow	P62	16	62	1 5/16	10
LCA250-12-X		1/2	1.17	1.25	.14	2.78	Yellow	P62	16	62	1 5/16	10
LCA300-56-X		5/16	1.19	1.44	.16	2.94	White	P66	17	66	1 1/2	10
LCA300-38-X	350 kcmil	3/8	1.19	1.44	.16	2.94	White	P66	17	66	1 1/2	10
LCA300-12-X		1/2	1.19	1.44	.16	3.05	White	P66	17	66	1 1/2	10
LCA300-58-X		5/8	1.19	1.44	.16	3.26	White	P66	17	66	1 1/2	10
LCA300-78-X	400 kcmil	7/8	1.19	1.44	.16	3.70	White	P66	17	66	1 1/2	10
LCA350-38-X		3/8	1.28	1.44	.17	2.98	Red	P71	18	71	1 1/2	10
LCA350-12-X		1/2	1.28	1.44	.17	3.09	Red	P71	18	71	1 1/2	10
LCA350-58-X	500 kcmil	5/8	1.28	1.44	.17	3.30	Red	P71	18	71	1 1/2	10
LCA350-78-X		7/8	1.28	1.44	.17	3.74	Red	P71	18	71	1 1/2	10
LCA400-38-6		3/8	1.39	1.50	.18	3.22	Blue	P76	19	76	1 9/16	6
LCA400-12-6	600 kcmil	1/2	1.39	1.50	.18	3.22	Blue	P76	19	76	1 9/16	6
LCA400-58-6		5/8	1.39	1.50	.18	3.43	Blue	P76	19	76	1 9/16	6
LCA400-78-6		7/8	1.39	1.50	.18	3.82	Blue	P76	19	76	1 9/16	6
LCA500-38-6	750 kcmil	3/8	1.54	1.75	.22	3.39	Brown	P87	20	87	1 13/16	6
LCA500-12-6		1/2	1.54	1.75	.22	3.55	Brown	P87	20	87	1 13/16	6
LCA500-58-6		5/8	1.54	1.75	.22	3.76	Brown	P87	20	87	1 13/16	6
LCA500-34-6	600 kcmil	3/4	1.54	1.75	.22	3.90	Brown	P87	20	87	1 13/16	6
LCA500-78-6		7/8	1.54	1.75	.22	4.15	Brown	P87	20	87	1 13/16	6
LCA500-1-6		1	1.54	1.75	.22	4.27	Brown	P87	20	87	1 13/16	6
LCA600-12-6	750 kcmil	1/2	1.70	1.75	.26	4.20	Green	P94	22	94	1 13/16	6
LCA600-58-6		5/8	1.70	1.75	.26	4.20	Green	P94	22	94	1 13/16	6
LCA600-78-6		7/8	1.70	1.75	.26	4.20	Green	P94	22	94	1 13/16	6
LCA750-58-6		5/8	1.89	1.88	.26	4.59	Black	P106	24	106	1 15/16	6

‡See pages D3.54 – D3.57 for tool and die information.

*Not tested to NEBS Level 3 requirements.

**Consult cable manufacturer for voltage stress relief instructions with applications greater than 2000 V.



Code Conductor, One-Hole, Standard Barrel with Window Lug, 45° Angle

For Use with Stranded Copper Conductors

Type LCA-H

- Color-coded barrels marked with *PANDUIT* and specified competitor die index numbers for proper crimp die selection
- Inspection window to visually assure full conductor insertion
- Tin-plated to inhibit corrosion
- UL Listed and CSA Certified to 35 KV** and temperature rated to 90°C when crimped with *PANDUIT* and specified competitor crimping tools and dies

- UL Listed and CSA Certified for wide wire range-taking capability when crimped with *PANDUIT*® *UNI-DIE*™ Dieless Crimping Tools‡
- **Tested by Telcordia – meets NEBS Level 3**
- American Bureau of Shipping approved

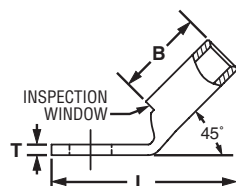
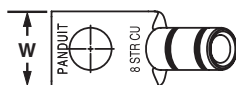

Part Number	Copper Conductor Size	Stud Hole Size (In.)	Figure Dimensions (In.)				PANDUIT Color Code	PANDUIT Die Index No.‡	Burndy Die Index No.‡	T&B Die Index No.‡	Wire Strip Length (In.)	Std. Pkg. Qty.
			W	B	T	L						
LCA10-14H-L*	#14 – 10 AWG STR, #12 – 10 AWG SOL	1/4	.42	.38	.05	1.05	—	—	—	—	7/16	50
LCA8-10H-L	#8 AWG	#10	.41	.56	.08	1.10	Red	P21	49	21	5/8	50
LCA8-14H-L		1/4	.48	.56	.07	1.19	Red	P21	49	21	5/8	50
LCA8-56H-L		5/16	.56	.56	.05	1.30	Red	P21	49	21	5/8	50
LCA8-38H-L		3/8	.60	.56	.05	1.40	Red	P21	49	21	5/8	50
LCA6-10H-L	#6 AWG	#10	.45	.81	.09	1.29	Blue	P24	7	24	7/8	50
LCA6-14H-L		1/4	.48	.81	.08	1.38	Blue	P24	7	24	7/8	50
LCA6-56H-L		5/16	.56	.81	.07	1.49	Blue	P24	7	24	7/8	50
LCA6-38H-L		3/8	.62	.81	.06	1.59	Blue	P24	7	24	7/8	50
LCA4-10H-L	#4 – 3 AWG STR, #2 AWG SOL	#10	.55	.81	.09	1.31	Gray	P29	8	29	7/8	50
LCA4-14H-L		1/4	.55	.81	.09	1.40	Gray	P29	8	29	7/8	50
LCA4-56H-L		5/16	.55	.81	.09	1.52	Gray	P29	8	29	7/8	50
LCA4-38H-L		3/8	.62	.81	.07	1.61	Gray	P29	8	29	7/8	50
LCA2-14H-Q	#2 AWG	1/4	.60	.88	.10	1.49	Brown	P33	10	33	15/16	25
LCA2-56H-Q		5/16	.66	.88	.10	1.61	Brown	P33	10	33	15/16	25
LCA2-38H-Q		3/8	.66	.88	.10	1.68	Brown	P33	10	33	15/16	25
LCA2-12H-Q		1/2	.75	.88	.08	1.90	Brown	P33	10	33	15/16	25

‡See pages D3.54 – D3.57 for tool and die information.

*Not tested to NEBS Level 3 requirements.

**Consult cable manufacturer for voltage stress relief instructions with applications greater than 2000 V.

Table continues on pages D2.16

A. System Overview

B1. Cable Ties

B2. Cable Accessories

B3. Stainless Steel Ties

C1. Wiring Duct

C2. Surface Raceway

C3. Abrasion Protection

C4. Cable Management

D1. Terminals

D2. Power Connectors

D3. Grounding Connectors

E1. Labeling Systems

E2. Labels

E3. Pre-Printed & Write-On Markers

E4. Permanent Identification

E5. Lockout/Tagout & Safety Solutions

F. Index

A.
System
Overview



Code Conductor, One-Hole, Standard Barrel with Window Lug, 45° Angle (continued)

B1.
Cable Ties

B2.
Cable
Accessories

B3.
Stainless
Steel Ties

C1.
Wiring
Duct

C2.
Surface
Raceway

C3.
Abrasion
Protection

C4.
Cable
Management

D1.
Terminals

D2.
Power
Connectors

D3.
Grounding
Connectors

E1.
Labeling
Systems

E2.
Labels

E3.
Pre-Printed
& Write-On
Markers

E4.
Permanent
Identification

E5.
Lockout/
Tagout
& Safety
Solutions

F.
Index

Part Number	Copper Conductor Size	Stud Hole Size (In.)	Figure Dimensions (In.)				PANDUIT Color Code	PANDUIT Die Index No.‡	Burndy Die Index No.‡	T&B Die Index No.‡	Wire Strip Length (In.)	Std. Pkg. Qty.
			W	B	T	L						
LCA1-14H-E	#1 AWG	1/4	.70	.88	.11	1.50	Green	P37	11	37	15/16	20
LCA1-56H-E		5/16	.70	.88	.11	1.62	Green	P37	11	37	15/16	20
LCA1-38H-E		3/8	.70	.88	.11	1.70	Green	P37	11	37	15/16	20
LCA1-12H-E		1/2	.75	.88	.09	1.93	Green	P37	11	37	15/16	20
LCA1/0-14H-X	1/0 AWG	1/4	.76	.94	.12	1.63	Pink	P42	12	42	1	10
LCA1/0-56H-X		5/16	.76	.94	.12	1.69	Pink	P42	12	42	1	10
LCA1/0-38H-X		3/8	.76	.94	.12	1.76	Pink	P42	12	42	1	10
LCA1/0-12H-X		1/2	.80	.94	.12	1.99	Pink	P42	12	42	1	10
LCA2/0-14H-X	2/0 AWG	1/4	.85	.98	.13	1.77	Black	P45	13	45	1 1/16	10
LCA2/0-56H-X		5/16	.85	.98	.13	1.77	Black	P45	13	45	1 1/16	10
LCA2/0-38H-X		3/8	.85	.98	.13	1.83	Black	P45	13	45	1 1/16	10
LCA2/0-12H-X		1/2	.85	.98	.13	2.08	Black	P45	13	45	1 1/16	10
LCA2/0-34H-X		3/4	1.06	.98	.09	2.66	Black	P45	13	45	1 1/16	10
LCA3/0-14H-X	3/0 AWG	1/4	.96	1.14	.13	1.90	Orange	P50	14	50	1 3/16	10
LCA3/0-56H-X		5/16	.96	1.14	.13	1.90	Orange	P50	14	50	1 3/16	10
LCA3/0-38H-X		3/8	.96	1.14	.13	1.96	Orange	P50	14	50	1 3/16	10
LCA3/0-12H-X		1/2	.96	1.14	.13	2.21	Orange	P50	14	50	1 3/16	10
LCA4/0-14H-X	4/0 AWG	1/4	1.06	1.19	.14	1.97	Purple	P54	15	54	1 1/4	10
LCA4/0-56H-X		5/16	1.06	1.19	.14	1.98	Purple	P54	15	54	1 1/4	10
LCA4/0-38H-X		3/8	1.06	1.19	.14	2.05	Purple	P54	15	54	1 1/4	10
LCA4/0-12H-X		1/2	1.06	1.19	.14	2.28	Purple	P54	15	54	1 1/4	10
LCA250-14H-X	250 kcmil	1/4	1.17	1.25	.14	2.05	Yellow	P62	16	62	1 5/16	10
LCA250-56H-X		5/16	1.17	1.25	.14	2.06	Yellow	P62	16	62	1 5/16	10
LCA250-38H-X		3/8	1.17	1.25	.14	2.13	Yellow	P62	16	62	1 5/16	10
LCA250-12H-X		1/2	1.17	1.25	.14	2.36	Yellow	P62	16	62	1 5/16	10
LCA300-56H-X	300 kcmil	5/16	1.19	1.44	.16	2.55	White	P66	17	66	1 1/2	10
LCA300-38H-X		3/8	1.19	1.44	.16	2.55	White	P66	17	66	1 1/2	10
LCA300-12H-X		1/2	1.19	1.44	.16	2.66	White	P66	17	66	1 1/2	10
LCA300-58H-X		5/8	1.19	1.44	.16	2.87	White	P66	17	66	1 1/2	10
LCA300-78H-X		7/8	1.19	1.44	.16	3.31	White	P66	17	66	1 1/2	10
LCA350-38H-X	350 kcmil	3/8	1.28	1.44	.17	2.59	Red	P71	18	71	1 1/2	10
LCA350-12H-X		1/2	1.28	1.44	.17	2.70	Red	P71	18	71	1 1/2	10
LCA350-58H-X		5/8	1.28	1.44	.17	2.91	Red	P71	18	71	1 1/2	10
LCA350-78H-X		7/8	1.28	1.44	.17	3.35	Red	P71	18	71	1 1/2	10
LCA400-38H-6	400 kcmil	3/8	1.39	1.50	.18	2.85	Blue	P76	19	76	1 9/16	6
LCA400-12H-6		1/2	1.39	1.50	.18	2.85	Blue	P76	19	76	1 9/16	6
LCA400-58H-6		5/8	1.39	1.50	.18	3.06	Blue	P76	19	76	1 9/16	6
LCA400-78H-6		7/8	1.39	1.50	.18	3.45	Blue	P76	19	76	1 9/16	6
LCA500-38H-6	500 kcmil	3/8	1.54	1.75	.22	2.94	Brown	P87	20	87	1 13/16	6
LCA500-12H-6		1/2	1.54	1.75	.22	3.10	Brown	P87	20	87	1 13/16	6
LCA500-58H-6		5/8	1.54	1.75	.22	3.31	Brown	P87	20	87	1 13/16	6
LCA500-34H-6		3/4	1.54	1.75	.22	3.45	Brown	P87	20	87	1 13/16	6
LCA500-78H-6		7/8	1.54	1.75	.22	3.70	Brown	P87	20	87	1 13/16	6
LCA500-1H-6		1	1.54	1.75	.22	3.82	Brown	P87	20	87	1 13/16	6
LCA600-12H-6	600 kcmil	1/2	1.70	1.75	.26	3.76	Green	P94	22	94	1 13/16	6
LCA600-58H-6		5/8	1.70	1.75	.26	3.76	Green	P94	22	94	1 13/16	6
LCA600-78H-6		7/8	1.70	1.75	.26	3.76	Green	P94	22	94	1 13/16	6

‡See pages D3.54 – D3.57 for tool and die information.

**Consult cable manufacturer for voltage stress relief instructions with applications greater than 2000 V.



Code Conductor, One-Hole, Standard Barrel with Window Lug, 90° Angle

For Use with Stranded Copper Conductors

Type LCA-F

- Color-coded barrels marked with *PANDUIT* and specified competitor die index numbers for proper crimp die selection
- Inspection window to visually assure full conductor insertion
- Tin-plated to inhibit corrosion
- UL Listed and CSA Certified to 35 KV** and temperature rated to 90°C when crimped with *PANDUIT* and specified competitor crimping tools and dies



- UL Listed and CSA Certified for wide wire range-taking capability when crimped with *PANDUIT*® *UNI-DIE*™ Dieless Crimping Tools‡
- **Tested by Telcordia – meets NEBS Level 3**
- American Bureau of Shipping Approved

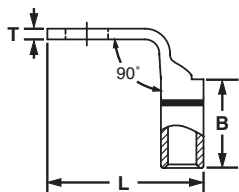
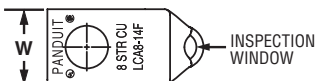

Part Number	Copper Conductor Size	Stud Hole Size (In.)	Figure Dimensions (In.)				PANDUIT Color Code	PANDUIT Die Index No.‡	Burdny Die Index No.‡	T&B Die Index No.‡	Wire Strip Length (In.)	Std. Pkg. Qty.
			W	B	T	L						
LCA10-14F-L*	#14 – 10 AWG STR, #12 – 10 AWG SOL	1/4	.42	.38	.05	.94	—	—	—	—	7/16	50
LCA8-10F-L	#8 AWG	#10	.41	.56	.08	.90	Red	P21	49	21	5/8	50
LCA8-14F-L		1/4	.48	.56	.07	.99	Red	P21	49	21	5/8	50
LCA8-56F-L		5/16	.56	.56	.05	1.11	Red	P21	49	21	5/8	50
LCA8-38F-L		3/8	.60	.56	.05	1.21	Red	P21	49	21	5/8	50
LCA6-10F-L	#6 AWG	#10	.45	.81	.09	.94	Blue	P24	7	24	7/8	50
LCA6-14F-L		1/4	.48	.81	.08	1.03	Blue	P24	7	24	7/8	50
LCA6-56F-L		5/16	.56	.81	.07	1.15	Blue	P24	7	24	7/8	50
LCA6-38F-L		3/8	.62	.81	.06	1.25	Blue	P24	7	24	7/8	50
LCA4-10F-L	#4 – 3 AWG STR, #2 AWG SOL	#10	.55	.81	.09	1.03	Gray	P29	8	29	7/8	50
LCA4-14F-L		1/4	.55	.81	.09	1.12	Gray	P29	8	29	7/8	50
LCA4-56F-L		5/16	.55	.81	.09	1.24	Gray	P29	8	29	7/8	50
LCA4-38F-L		3/8	.62	.81	.07	1.34	Gray	P29	8	29	7/8	50
LCA2-14F-Q	#2 AWG	1/4	.60	.88	.10	1.24	Brown	P33	10	33	15/16	25
LCA2-56F-Q		5/16	.66	.88	.10	1.36	Brown	P33	10	33	15/16	25
LCA2-38F-Q		3/8	.66	.88	.10	1.44	Brown	P33	10	33	15/16	25
LCA2-12F-Q		1/2	.75	.88	.08	1.67	Brown	P33	10	33	15/16	25
LCA1-14F-E	#1 AWG	1/4	.70	.88	.11	1.31	Green	P37	11	37	15/16	20
LCA1-56F-E		5/16	.70	.88	.11	1.44	Green	P37	11	37	15/16	20
LCA1-38F-E		3/8	.70	.88	.11	1.51	Green	P37	11	37	15/16	20
LCA1-12F-E		1/2	.75	.88	.09	1.75	Green	P37	11	37	15/16	20
LCA1/0-14F-X	1/0 AWG	1/4	.76	.94	.12	1.45	Pink	P42	12	42	1	10
LCA1/0-56F-X		5/16	.76	.94	.12	1.51	Pink	P42	12	42	1	10
LCA1/0-38F-X		3/8	.76	.94	.12	1.58	Pink	P42	12	42	1	10
LCA1/0-12F-X		1/2	.80	.94	.12	1.82	Pink	P42	12	42	1	10
LCA2/0-14F-X	2/0 AWG	1/4	.85	.98	.13	1.61	Black	P45	13	45	1 1/16	10
LCA2/0-56F-X		5/16	.85	.98	.13	1.59	Black	P45	13	45	1 1/16	10
LCA2/0-38F-X		3/8	.85	.98	.13	1.66	Black	P45	13	45	1 1/16	10
LCA2/0-12F-X		1/2	.85	.98	.13	1.91	Black	P45	13	45	1 1/16	10

‡See pages D3.54 – D3.57 for tool and die information.

*Not tested to NEBS Level 3 requirements.

**Consult cable manufacturer for voltage stress relief instructions with applications greater than 2000 V.

Table continues on pages D2.18

A. System Overview

B1. Cable Ties

B2. Cable Accessories

B3. Stainless Steel Ties

C1. Wiring Duct

C2. Surface Raceway

C3. Abrasion Protection

C4. Cable Management

D1. Terminals

D2. Power Connectors

D3. Grounding Connectors

E1. Labeling Systems

E2. Labels

E3. Pre-Printed & Write-On Markers

E4. Permanent Identification

E5. Lockout/Tagout & Safety Solutions

F. Index

A.
System
Overview



Code Conductor, One-Hole, Standard Barrel with Window Lug, 90° Angle (continued)

B1.
Cable Ties

B2.
Cable
Accessories

B3.
Stainless
Steel Ties

C1.
Wiring
Duct

C2.
Surface
Raceway

C3.
Abrasion
Protection

C4.
Cable
Management

D1.
Terminals

D2.
Power
Connectors

D3.
Grounding
Connectors

E1.
Labeling
Systems

E2.
Labels

E3.
Pre-Printed
& Write-On
Markers

E4.
Permanent
Identification

E5.
Lockout/
Tagout
& Safety
Solutions

F.
Index

Part Number	Copper Conductor Size	Stud Hole Size (In.)	Figure Dimensions (In.)				PANDUIT Color Code	PANDUIT Die Index No.‡	Burdny Die Index No.‡	T&B Die Index No.‡	Wire Strip Length (In.)	Std. Pkg. Qty.
			W	B	T	L						
LCA3/0-14F-X	3/0 AWG	1/4	.96	1.14	.13	1.67	Orange	P50	14	50	1 3/16	10
LCA3/0-56F-X		5/16	.96	1.14	.13	1.67	Orange	P50	14	50	1 3/16	10
LCA3/0-38F-X		3/8	.96	1.14	.13	1.73	Orange	P50	14	50	1 3/16	10
LCA3/0-12F-X		1/2	.96	1.14	.13	1.98	Orange	P50	14	50	1 3/16	10
LCA4/0-14F-X	4/0 AWG	1/4	1.06	1.19	.14	1.75	Purple	P54	15	54	1 1/4	10
LCA4/0-56F-X		5/16	1.06	1.19	.14	1.77	Purple	P54	15	54	1 1/4	10
LCA4/0-38F-X		3/8	1.06	1.19	.14	1.84	Purple	P54	15	54	1 1/4	10
LCA4/0-12F-X		1/2	1.06	1.19	.14	2.07	Purple	P54	15	54	1 1/4	10
LCA250-14F-X	250 kcmil	1/4	1.17	1.25	.14	1.82	Yellow	P62	16	62	1 5/16	10
LCA250-56F-X		5/16	1.17	1.25	.14	1.83	Yellow	P62	16	62	1 5/16	10
LCA250-38F-X		3/8	1.17	1.25	.14	1.90	Yellow	P62	16	62	1 5/16	10
LCA250-12F-X		1/2	1.17	1.25	.14	2.13	Yellow	P62	16	62	1 5/16	10
LCA300-56F-X	300 kcmil	5/16	1.19	1.44	.16	2.07	White	P66	17	66	1 1/2	10
LCA300-38F-X		3/8	1.19	1.44	.16	2.07	White	P66	17	66	1 1/2	10
LCA300-12F-X		1/2	1.19	1.44	.16	2.18	White	P66	17	66	1 1/2	10
LCA300-58F-X		5/8	1.19	1.44	.16	2.39	White	P66	17	66	1 1/2	10
LCA300-78F-X		7/8	1.19	1.44	.16	2.83	White	P66	17	66	1 1/2	10
LCA350-38F-X	350 kcmil	3/8	1.28	1.44	.17	2.13	Red	P71	18	71	1 1/2	10
LCA350-12F-X		1/2	1.28	1.44	.17	2.24	Red	P71	18	71	1 1/2	10
LCA350-58F-X		5/8	1.28	1.44	.17	2.45	Red	P71	18	71	1 1/2	10
LCA350-78F-X		7/8	1.28	1.44	.17	2.89	Red	P71	18	71	1 1/2	10
LCA400-38F-6	400 kcmil	3/8	1.39	1.50	.18	2.37	Blue	P76	19	76	1 9/16	6
LCA400-12F-6		1/2	1.39	1.50	.18	2.37	Blue	P76	19	76	1 9/16	6
LCA400-58F-6		5/8	1.39	1.50	.18	2.58	Blue	P76	19	76	1 9/16	6
LCA400-78F-6		7/8	1.39	1.50	.18	2.97	Blue	P76	19	76	1 9/16	6
LCA500-38F-6	500 kcmil	3/8	1.54	1.75	.22	2.32	Brown	P87	20	87	1 13/16	6
LCA500-12F-6		1/2	1.54	1.75	.22	2.48	Brown	P87	20	87	1 13/16	6
LCA500-58F-6		5/8	1.54	1.75	.22	2.69	Brown	P87	20	87	1 13/16	6
LCA500-34F-6		3/4	1.54	1.75	.22	2.83	Brown	P87	20	87	1 13/16	6
LCA500-78F-6		7/8	1.54	1.75	.22	3.08	Brown	P87	20	87	1 13/16	6
LCA500-1F-6		1	1.54	1.75	.22	3.20	Brown	P87	20	87	1 13/16	6
LCA600-12F-6	600 kcmil	1/2	1.70	1.75	.26	3.21	Green	P94	22	94	1 13/16	6
LCA600-58F-6		5/8	1.70	1.75	.26	3.21	Green	P94	22	94	1 13/16	6
LCA600-78F-6		7/8	1.70	1.75	.26	3.21	Green	P94	22	94	1 13/16	6

‡See pages D3.54 – D3.57 for tool and die information.

**Consult cable manufacturer for voltage stress relief instructions with applications greater than 2000 V.



Code Conductor, One-Hole, Standard Barrel with Window, Narrow Tongue Lug

For Use with Stranded Copper Conductors

Type LKAN

- Narrow tongue width for limited space applications
- Color-coded barrels marked with *PANDUIT* and specified competitor die index numbers for proper crimp die selection
- Inspection window to visually assure full conductor insertion
- Tin-plated to inhibit corrosion
- UL Listed and CSA Certified to 35 KV** and temperature rated to 90°C when crimped with *PANDUIT* and specified competitor crimping tools and dies
- UL Listed and CSA Certified for wide wire range-taking capability when crimped with *PANDUIT*® *UNI-DIE*™ Dieless Crimping Tools‡

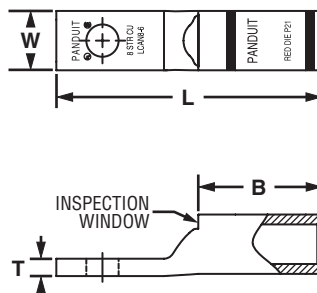

Part Number	Copper Conductor Size	Stud Hole Size (In.)	Figure Dimensions (In.)				PANDUIT Color Code	PANDUIT Die Index No.‡	Burndy Die Index No.‡	T&B Die Index No.‡	Wire Strip Length (In.)	Std. Pkg. Qty.
			W	B	T	L						
LCAN8-6-L	#8 AWG	#6	.27	.56	.09	1.24	Red	P21	49	21	5/8	50
LCAN6-6-L	#6 AWG	#6	.31	.81	.09	1.51	Blue	P24	7	24	7/8	50
LCAN4-10-L	#4 – 3 AWG, #2 AWG SOL	#10	.38	.81	.10	1.54	Gray	P29	8	29	7/8	50
LCAN4-14-L		1/4	.38	.81	.10	1.63	Gray	P29	8	29	7/8	50
LCAN2-10-Q	#3 – 2 AWG	#10	.42	.88	.11	1.67	Brown	P33	10	33	15/16	25
LCAN2-14-Q		1/4	.42	.88	.11	1.77	Brown	P33	10	33	15/16	25
LCAN1-10-E	#1 AWG	#10	.47	.88	.11	1.69	Green	P37	11	37	15/16	20
LCAN1-14-E		1/4	.47	.88	.11	1.79	Green	P37	11	37	15/16	20
LCAN1/0-10-X	1/0 AWG	#10	.52	.94	.13	1.78	Pink	P42	12	42	1	10
LCAN1/0-14-X		1/4	.52	.94	.13	1.95	Pink	P42	12	42	1	10
LCAN1/0-56-X		5/16	.52	.94	.13	2.00	Pink	P42	12	42	1	10
LCAN2/0-10-X	2/0 AWG	#10	.58	.98	.13	1.84	Black	P45	13	45	1 1/16	10
LCAN2/0-14-X		1/4	.58	.98	.13	2.09	Black	P45	13	45	1 1/16	10
LCAN2/0-56-X		5/16	.58	.98	.13	2.09	Black	P45	13	45	1 1/16	10
LCAN2/0-38-X	3/8	.58	.98	.13	2.15	Black	P45	13	45	1 1/16	10	
LCAN3/0-14-X	3/0 AWG	1/4	.64	1.14	.13	2.28	Orange	P50	14	50	1 3/16	10
LCAN3/0-56-X		5/16	.64	1.14	.13	2.28	Orange	P50	14	50	1 3/16	10
LCAN3/0-38-X		3/8	.64	1.14	.13	2.34	Orange	P50	14	50	1 3/16	10
LCAN4/0-14-X	4/0 AWG	1/4	.71	1.19	.14	2.36	Purple	P54	15	54	1 1/4	10
LCAN4/0-56-X		5/16	.71	1.19	.14	2.38	Purple	P54	15	54	1 1/4	10
LCAN4/0-38-X		3/8	.71	1.19	.14	2.45	Purple	P54	15	54	1 1/4	10

‡See pages D3.54 – D3.57 for tool and die information.

**Consult cable manufacturer for voltage stress relief instructions with applications greater than 2000 V.

Table continues on page D2.20

- A. System Overview
- B1. Cable Ties
- B2. Cable Accessories
- B3. Stainless Steel Ties
- C1. Wiring Duct
- C2. Surface Raceway
- C3. Abrasion Protection
- C4. Cable Management
- D1. Terminals
- D2. Power Connectors
- D3. Grounding Connectors
- E1. Labeling Systems
- E2. Labels
- E3. Pre-Printed & Write-On Markers
- E4. Permanent Identification
- E5. Lockout/Tagout & Safety Solutions
- F. Index

A.
System
Overview



Code Conductor, One-Hole, Standard Barrel with Window, Narrow Tongue Lug (continued)

B1.
Cable Ties

Part Number	Copper Conductor Size	Stud Hole Size (In.)	Figure Dimensions (In.)				PANDUIT Color Code	PANDUIT Die Index No.‡	Burndy Die Index No.‡	T&B Die Index No.‡	Wire Strip Length (In.)	Std. Pkg. Qty.
			W	B	T	L						
LCAN250-14-X	250 kcmil	1/4	.77	1.25	.14	2.47	Yellow	P62	16	62	1 5/16	10
LCAN250-38-X		3/8	.77	1.25	.14	2.55	Yellow	P62	16	62	1 5/16	10
LCAN300-14-X	300 kcmil	1/4	.81	1.44	.16	2.90	White	P66	17	66	1 1/2	10
LCAN300-38-X		3/8	.81	1.44	.16	2.94	White	P66	17	66	1 1/2	10
LCAN350-38-X	350 kcmil	3/8	.88	1.44	.17	2.98	Red	P71	18	71	1 1/2	10
LCAN350-12-X		1/2	.88	1.44	.17	3.09	Red	P71	18	71	1 1/2	10
LCAN400-38-6	400 kcmil	3/8	.95	1.50	.18	3.22	Blue	P76	19	76	1 9/16	6
LCAN400-12-6		1/2	.95	1.50	.18	3.22	Blue	P76	19	76	1 9/16	6
LCAN500-38-6	500 kcmil	3/8	1.06	1.75	.22	3.39	Brown	P87	20	87	1 13/16	6
LCAN500-12-6		1/2	1.06	1.75	.22	3.55	Brown	P87	20	87	1 13/16	6
LCAN600-38-6	600 kcmil	3/8	1.19	1.75	.27	3.44	Green	P94	22	94	1 13/16	6
LCAN600-12-6		1/2	1.19	1.75	.27	4.20	Green	P94	22	94	1 13/16	6
LCAN750-38-6	750 kcmil	3/8	1.30	1.88	.28	3.84	Black	P106	24	106	1 15/16	6
LCAN750-12-6		1/2	1.30	1.88	.28	4.03	Black	P106	24	106	1 15/16	6
LCAN750-58-6		5/8	1.30	1.88	.28	4.59	Black	P106	24	106	1 15/16	6

B2.
Cable
Accessories

B3.
Stainless
Steel Ties

C1.
Wiring
Duct

C2.
Surface
Raceway

C3.
Abrasion
Protection

C4.
Cable
Management

‡See pages D3.54 – D3.57 for tool and die information.
**Consult cable manufacturer for voltage stress relief instructions with applications greater than 2000 V.

D1.
Terminals

D2.
Power
Connectors

D3.
Grounding
Connectors

E1.
Labeling
Systems

E2.
Labels

E3.
Pre-Printed
& Write-On
Markers

E4.
Permanent
Identification

E5.
Lockout/
Tagout/
& Safety
Solutions

F.
Index

UL® CERTIFIED Code Conductor, Short Blank Tongue, Standard Barrel with Window Lug

For Use with Stranded Copper Conductors

Type LCA-00

- Color-coded barrels marked with *PANDUIT* and specified competitor die index numbers for proper crimp die selection
- Inspection window to visually assure full conductor insertion

- Tin-plated to inhibit corrosion
- UL Recognized and CSA Certified to 35 KV** and temperature rated to 90°C when crimped with *PANDUIT* and specified competitor crimping tools and dies

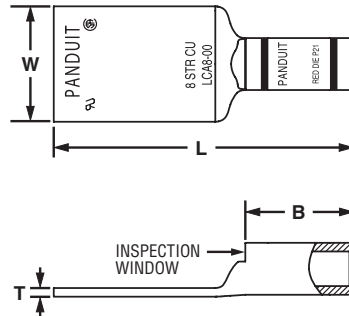

Part Number	Copper Conductor Size	Figure Dimensions (In.)				PANDUIT Color Code	PANDUIT Die Index No.‡	Burdny Die Index No.‡	T&B Die Index No.‡	Wire Strip Length (In.)	Std. Pkg. Qty.
		W	B	T	L						
LCA8-00-L	#8 AWG	.60	.56	.05	1.56	Red	P21	49	21	5/8	50
LCA6-00-L	#6 AWG	.62	.81	.06	1.83	Blue	P24	7	24	7/8	50
LCA4-00-L	#4 – 3 AWG STR, #2 AWG SOL	.62	.81	.07	1.85	Gray	P29	8	29	7/8	50
LCA2-00-Q	#2 AWG	.75	.88	.08	2.21	Brown	P33	10	33	15/16	25
LCA1-00-E	#1 AWG	.75	.88	.09	2.23	Green	P37	11	37	15/16	20
LCA1/0-00-X	1/0 AWG	.80	.94	.12	2.31	Pink	P42	12	42	1	10
LCA2/0-00-X	2/0 AWG	.85	.98	.13	2.40	Black	P45	13	45	1 1/16	10
LCA3/0-00-X	3/0 AWG	.96	1.14	.13	2.59	Orange	P50	14	50	1 3/16	10
LCA4/0-00-X	4/0 AWG	1.06	1.19	.14	2.68	Purple	P54	15	54	1 1/4	10
LCA300-00-X	300 kcmil	1.19	1.44	.16	3.70	White	P66	17	66	1 1/2	10
LCA350-00-X	350 kcmil	1.28	1.44	.17	3.74	Red	P71	18	71	1 1/2	10
LCA400-00-6	400 kcmil	1.39	1.50	.18	3.82	Blue	P76	19	76	1 9/16	6
LCA500-00-6	500 kcmil	1.54	1.75	.22	4.27	Brown	P87	20	87	1 13/16	6
LCA600-00-6	600 kcmil	1.70	1.75	.26	4.20	Green	P94	22	94	1 13/16	6

‡See pages D3.54 – D3.57 for tool and die information.

**Consult cable manufacturer for voltage stress relief instructions with applications greater than 2000 V.

A. System Overview

B1. Cable Ties

B2. Cable Accessories

B3. Stainless Steel Ties

C1. Wiring Duct

C2. Surface Raceway

C3. Abrasion Protection

C4. Cable Management

D1. Terminals

D2. Power Connectors

D3. Grounding Connectors

E1. Labeling Systems

E2. Labels

E3. Pre-Printed & Write-On Markers

E4. Permanent Identification

E5. Lockout/Tagout & Safety Solutions

F. Index

A. System Overview



Code Conductor, One-Hole, Long Barrel Lug

B1. Cable Ties

For Use with Stranded Copper Conductors

Type LCB

- Long barrel maximizes number of crimps and provides premium wire pull-out strength and electrical performance
- Color-coded barrels marked with *PANDUIT* and specified competitor die index numbers for proper crimp die selection
- Enclosed barrel prevents corrosive material from entering barrel when used in harsh environments
- Tin-plated to inhibit corrosion

- UL Listed and CSA Certified to 35 KV** and temperature rated to 90°C when crimped with *PANDUIT* and specified competitor crimping tools and dies
- UL Listed and CSA Certified for wide wire range-taking capability when crimped with *PANDUIT*® *UNI-DIE*™ Dieless Crimping Tools‡
- **Tested by Telcordia – meets NEBS Level 3**
- American Bureau of Shipping approved

C1. Wiring Duct

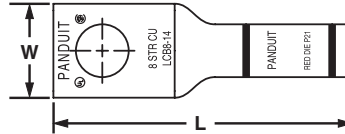

C2. Surface Raceway

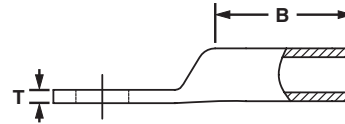

C3. Abrasion Protection

C4. Cable Management

Part Number	Copper Conductor Size	Stud Hole Size (In.)	Figure Dimensions (In.)				PANDUIT Color Code	PANDUIT Die Index No.‡	Burndy Die Index No.‡	T&B Die Index No.‡	Wire Strip Length (In.)	Std. Pkg. Qty.
			W	B	T	L						
LCB8-10-L	#8 AWG	#10	.41	.70	.08	1.44	Red	P21	49	21	3/4	50
LCB8-14-L		1/4	.48	.70	.07	1.53	Red	P21	49	21	3/4	50
LCB8-38-L		3/8	.60	.70	.05	1.75	Red	P21	49	21	3/4	50
LCB6-10-L	#6 AWG	#10	.45	1.07	.09	1.84	Blue	P24	7	24	1 1/8	50
LCB6-14-L		1/4	.48	1.07	.08	1.93	Blue	P24	7	24	1 1/8	50
LCB6-38-L		3/8	.62	1.07	.05	2.15	Blue	P24	7	24	1 1/8	50
LCB4-10-L	#4 – 3 AWG STR, #2 AWG SOL	#10	.55	1.05	.09	1.86	Gray	P29	8	29	1 1/8	50
LCB4-14-L		1/4	.55	1.05	.09	1.95	Gray	P29	8	29	1 1/8	50
LCB4-56-L		5/16	.62	1.05	.07	2.13	Gray	P29	8	29	1 1/8	50
LCB4-38-L	3/8	.62	1.05	.07	2.17	Gray	P29	8	29	1 1/8	50	
LCB2-10-Q	#2 AWG	#10	.60	1.16	.10	2.07	Brown	P33	10	33	1 1/4	25
LCB2-56-Q		5/16	.66	1.16	.10	2.27	Brown	P33	10	33	1 1/4	25
LCB2-38-Q		3/8	.66	1.16	.10	2.34	Brown	P33	10	33	1 1/4	25
LCB1-10-E	#1 AWG	#10	.70	1.36	.11	2.30	Green	P37	11	37	1 7/16	20
LCB1-56-E		5/16	.70	1.36	.11	2.50	Green	P37	11	37	1 7/16	20
LCB1-38-E		3/8	.70	1.36	.11	2.57	Green	P37	11	37	1 7/16	20
LCB1/0-10-X	1/0 AWG	#10	.76	1.44	.12	2.41	Pink	P42	12	42	1 1/2	10
LCB1/0-56-X		5/16	.76	1.44	.12	2.61	Pink	P42	12	42	1 1/2	10
LCB1/0-38-X		3/8	.76	1.44	.12	2.69	Pink	P42	12	42	1 1/2	10
LCB1/0-12-X		1/2	.80	1.44	.12	2.92	Pink	P42	12	42	1 1/2	10

‡See pages D3.58 – D3.61 for tool and die information.

**Consult cable manufacturer for voltage stress relief instructions with applications greater than 2000 V.

E3. Pre-Printed & Write-On Markers

E4. Permanent Identification

E5. Lockout/Tagout & Safety Solutions

F. Index



Code Conductor, One-Hole, Long Barrel Lug (continued)

Part Number	Copper Conductor Size	Stud Hole Size (In.)	Figure Dimensions (In.)				PANDUIT Color Code	PANDUIT Die Index No.‡	Burndy Die Index No.‡	T&B Die Index No.‡	Wire Strip Length (In.)	Std. Pkg. Qty.
			W	B	T	L						
LCB2/0-38-X	2/0 AWG	3/8	.85	1.50	.13	2.82	Black	P45	13	45	1 9/16	10
LCB2/0-12-X		1/2	.85	1.50	.13	3.07	Black	P45	13	45	1 9/16	10
LCB3/0-38-X	3/0 AWG	3/8	.96	1.50	.13	2.87	Orange	P50	14	50	1 9/16	10
LCB3/0-12-X		1/2	.96	1.50	.13	3.12	Orange	P50	14	50	1 9/16	10
LCB4/0-38-X	4/0 AWG	3/8	1.06	1.56	.14	3.03	Purple	P54	15	54	1 5/8	10
LCB4/0-12-X		1/2	1.06	1.56	.14	3.22	Purple	P54	15	54	1 5/8	10
LCB250-12-X	250 kcmil	1/2	1.17	1.61	.14	3.32	Yellow	P62	16	62	1 11/16	10
LCB250-78-X		7/8	1.25	1.61	.12	3.85	Yellow	P62	16	62	1 11/16	10
LCB300-56-X	300 kcmil	5/16	1.19	2.24	.16	3.95	White	P66	17	66	2 5/16	10
LCB300-38-X		3/8	1.19	2.24	.16	3.95	White	P66	17	66	2 5/16	10
LCB300-12-X		1/2	1.19	2.24	.16	4.06	White	P66	17	66	2 5/16	10
LCB350-12-X	350 kcmil	1/2	1.28	2.24	.17	4.11	Red	P71	18	71	2 5/16	10
LCB350-78-X		7/8	1.28	2.24	.17	4.78	Red	P71	18	71	2 5/16	10
LCB400-38-6	400 kcmil	3/8	1.39	2.30	.18	4.27	Blue	P76	19	76	2 3/8	6
LCB400-12-6		1/2	1.39	2.30	.18	4.27	Blue	P76	19	76	2 3/8	6
LCB400-58-6		5/8	1.39	2.30	.18	4.48	Blue	P76	19	76	2 3/8	6
LCB400-78-6	500 kcmil	7/8	1.39	2.30	.18	4.88	Blue	P76	19	76	2 3/8	6
LCB500-12-6		1/2	1.54	2.50	.22	4.53	Brown	P87	20	87	2 9/16	6
LCB500-58-6		5/8	1.54	2.50	.22	4.74	Brown	P87	20	87	2 9/16	6
LCB500-78-6	600 kcmil	7/8	1.54	2.50	.22	5.13	Brown	P87	20	87	2 9/16	6
LCB600-12-6		1/2	1.70	2.69	.26	5.40	Green	P94	22	94	2 3/4	6
LCB600-58-6		5/8	1.70	2.69	.26	5.40	Green	P94	22	94	2 3/4	6
LCB750-58-6	750 kcmil	5/8	1.89	2.88	.26	5.98	Black	P106	24	106	2 15/16	6
LCB750-78-6		7/8	1.89	2.88	.26	6.07	Black	P106	24	106	2 15/16	6
LCB800-58-6	800 kcmil	5/8	1.95	2.94	.29	6.06	Orange	P107	25	107	3	6
LCB1000-58-3	1000 kcmil	5/8	2.17	3.00	.32	6.32	White	P125	27	125	3 1/16	3

‡See pages D3.58 – D3.61 for tool and die information.

**Consult cable manufacturer for voltage stress relief instructions with applications greater than 2000 V.

A.
System
Overview

B1.
Cable Ties

B2.
Cable
Accessories

B3.
Stainless
Steel Ties

C1.
Wiring
Duct

C2.
Surface
Raceway

C3.
Abrasion
Protection

C4.
Cable
Management

D1.
Terminals

D2.
Power
Connectors

D3.
Grounding
Connectors

E1.
Labeling
Systems

E2.
Labels

E3.
Pre-Printed
& Write-On
Markers

E4.
Permanent
Identification

E5.
Lockout/
Tagout
& Safety
Solutions

F.
Index

A. System Overview



Code Conductor, One-Hole, Long Barrel Lug, 45° Angle

For Use with Stranded Copper Conductors

Type LCB-H

- Long barrel maximizes number of crimps and provides premium wire pull-out strength and electrical performance
- Color-coded barrels marked with *PANDUIT* and specified competitor die index numbers for proper crimp die selection
- Enclosed barrel prevents corrosive material from entering barrel when used in harsh environments
- Tin-plated to inhibit corrosion

- UL Listed and CSA Certified to 35 KV** and temperature rated to 90°C when crimped with *PANDUIT* and specified competitor crimping tools and dies
- UL Listed and CSA Certified for wide wire range-taking capability when crimped with *PANDUIT*® *UNI-DIE*™ Dieless Crimping Tools‡
- **Tested by Telcordia – meets NEBS Level 3**
- American Bureau of Shipping approved

B1. Cable Ties

B2. Cable Accessories

B3. Stainless Steel Ties

C1. Wiring Duct

C2. Surface Raceway

C3. Abrasion Protection

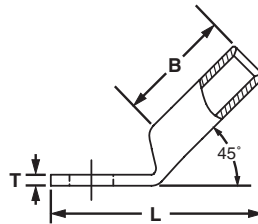
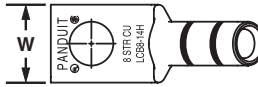

C4. Cable Management

D1. Terminals

D2. Power Connectors

D3. Grounding Connectors

E1. Labeling Systems

E2. Labels

E3. Pre-Printed & Write-On Markers

E4. Permanent Identification

E5. Lockout/Tagout & Safety Solutions

F. Index

Part Number	Copper Conductor Size	Stud Hole Size (In.)	Figure Dimensions (In.)				PANDUIT Color Code	PANDUIT Die Index No.‡	Burndy Die Index No.‡	T&B Die Index No.‡	Wire Strip Length (In.)	Std. Pkg. Qty.
			W	B	T	L						
LCB8-10H-L	#8 AWG	#10	.41	.70	.08	1.23	Red	P21	49	21	3/4	50
LCB8-14H-L		1/4	.48	.70	.07	1.31	Red	P21	49	21	3/4	50
LCB6-10H-L	#6 AWG	#10	.45	1.07	.09	1.52	Blue	P24	7	24	1 1/8	50
LCB6-14H-L		1/4	.48	1.07	.08	1.60	Blue	P24	7	24	1 1/8	50
LCB6-38H-L		3/8	.62	1.07	.05	1.81	Blue	P24	7	24	1 1/8	50
LCB4-10H-L	#4 – 3 AWG STR, #2 AWG SOL	#10	.55	1.05	.09	1.54	Gray	P29	8	29	1 1/8	50
LCB4-14H-L		1/4	.55	1.05	.09	1.63	Gray	P29	8	29	1 1/8	50
LCB2-10H-Q	#2 AWG	#10	.60	1.16	.10	1.68	Brown	P33	10	33	1 1/4	25
LCB2-56H-Q		5/16	.66	1.16	.10	1.87	Brown	P33	10	33	1 1/4	25
LCB1-10H-E	#1 AWG	#10	.70	1.36	.11	1.83	Green	P37	11	37	1 7/16	20
LCB1-56H-E		5/16	.70	1.36	.11	2.03	Green	P37	11	37	1 7/16	20
LCB1/0-10H-X	1/0 AWG	#10	.76	1.44	.12	1.92	Pink	P42	12	42	1 1/2	10
LCB1/0-56H-X		5/16	.76	1.44	.12	2.12	Pink	P42	12	42	1 1/2	10
LCB1/0-38H-X		3/8	.76	1.44	.12	2.19	Pink	P42	12	42	1 1/2	10
LCB1/0-12H-X		1/2	.80	1.44	.11	2.42	Pink	P42	12	42	1 1/2	10
LCB2/0-38H-X	2/0 AWG	3/8	.85	1.50	.13	2.31	Black	P45	13	45	1 9/16	10
LCB2/0-12H-X		1/2	.85	1.50	.13	2.53	Black	P45	13	45	1 9/16	10
LCB3/0-38H-X	3/0 AWG	3/8	.96	1.50	.13	2.33	Orange	P50	14	50	1 9/16	10
LCB3/0-12H-X		1/2	.96	1.50	.13	2.58	Orange	P50	14	50	1 9/16	10

‡See pages D3.58 – D3.61 for tool and die information.

**Consult cable manufacturer for voltage stress relief instructions with applications greater than 2000 V.



Code Conductor, One-Hole, Long Barrel Lug, 45° Angle (continued)

Part Number	Copper Conductor Size	Stud Hole Size (In.)	Figure Dimensions (In.)				PANDUIT Color Code	PANDUIT Die Index No.‡	Burdmy Die Index No.‡	T&B Die Index No.‡	Wire Strip Length (In.)	Std. Pkg. Qty.
			W	B	T	L						
LCB4/0-38H-X	4/0 AWG	3/8	1.06	1.56	.14	2.48	Purple	P54	15	54	1 5/8	10
LCB4/0-12H-X		1/2	1.06	1.56	.14	2.67	Purple	P54	15	54	1 5/8	10
LCB250-12H-X	250 kcmil	1/2	1.17	1.61	.14	2.74	Yellow	P62	16	62	1 11/16	10
LCB250-78H-X		7/8	1.25	1.61	.12	3.27	Yellow	P62	16	62	1 11/16	10
LCB300-56H-X	300 kcmil	5/16	1.19	2.24	.16	3.24	White	P66	17	66	2 5/16	10
LCB300-38H-X		3/8	1.19	2.24	.16	3.24	White	P66	17	66	2 5/16	10
LCB300-12H-X		1/2	1.19	2.24	.16	3.35	White	P66	17	66	2 5/16	10
LCB350-12H-X	350 kcmil	1/2	1.28	2.24	.17	3.39	Red	P71	18	71	2 5/16	10
LCB350-78H-X		7/8	1.28	2.24	.17	4.04	Red	P71	18	71	2 5/16	10
LCB400-12H-6	400 kcmil	1/2	1.39	2.30	.18	3.53	Blue	P76	19	76	2 3/8	6
LCB400-58H-6		5/8	1.39	2.30	.18	3.74	Blue	P76	19	76	2 3/8	6
LCB400-78H-6		7/8	1.39	2.30	.18	4.13	Blue	P76	19	76	2 3/8	6
LCB500-12H-6	500 kcmil	1/2	1.54	2.50	.22	3.74	Brown	P87	20	87	2 9/16	6
LCB500-58H-6		5/8	1.54	2.50	.22	3.95	Brown	P87	20	87	2 9/16	6
LCB500-78H-6		7/8	1.54	2.50	.22	4.34	Brown	P87	20	87	2 9/16	6
LCB600-12H-6	600 kcmil	1/2	1.70	2.69	.26	4.56	Green	P94	22	94	2 3/4	6
LCB600-58H-6		5/8	1.70	2.69	.26	4.56	Green	P94	22	94	2 3/4	6

‡See pages D3.58 – D3.61 for tool and die information.

**Consult cable manufacturer for voltage stress relief instructions with applications greater than 2000 V.

A.
System
Overview

B1.
Cable Ties

B2.
Cable
Accessories

B3.
Stainless
Steel Ties

C1.
Wiring
Duct

C2.
Surface
Raceway

C3.
Abrasion
Protection

C4.
Cable
Management

D1.
Terminals

D2.
Power
Connectors

D3.
Grounding
Connectors

E1.
Labeling
Systems

E2.
Labels

E3.
Pre-Printed
& Write-On
Markers

E4.
Permanent
Identification

E5.
Lockout/
Tagout
& Safety
Solutions

F.
Index

A. System Overview

UL LISTED **CSA CERTIFIED** **Code Conductor, One-Hole, Long Barrel Lug, 90° Angle**

For Use with Stranded Copper Conductors
Type LCB-F

- Long barrel maximizes number of crimps and provides premium wire pull-out strength and electrical performance
- Color-coded barrels marked with *PANDUIT* and specified competitor die index numbers for proper crimp die selection
- Enclosed barrel prevents corrosive material from entering barrel when used in harsh environments
- Tin-plated to inhibit corrosion

- UL Listed and CSA Certified to 35 KV** and temperature rated to 90°C when crimped with *PANDUIT* and specified competitor crimping tools and dies
- UL Listed and CSA Certified for wide wire range-taking capability when crimped with *PANDUIT*® *UNI-DIE*™ Dieless Crimping Tools‡
- **Tested by Telcordia – meets NEBS Level 3**
- American Bureau of Shipping approved

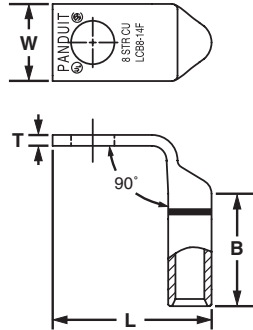

Part Number	Copper Conductor Size	Stud Hole Size (In.)	Figure Dimensions (In.)				PANDUIT Color Code	PANDUIT Die Index No.‡	Burndy Die Index No.‡	T&B Die Index No.‡	Wire Strip Length (In.)	Std. Pkg. Qty.
			W	B	T	L						
LCB8-10F-L	#8 AWG	#10	.41	.70	.08	1.08	Red	P21	49	21	3/4	50
LCB8-14F-L		1/4	.48	.70	.07	1.07	Red	P21	49	21	3/4	50
LCB6-10F-L	#6 AWG	#10	.45	1.07	.09	1.49	Blue	P24	7	24	1 1/8	50
LCB6-14F-L		1/4	.48	1.07	.08	1.48	Blue	P24	7	24	1 1/8	50
LCB6-38F-L		3/8	.62	1.07	.05	1.45	Blue	P24	7	24	1 1/8	50
LCB4-10F-L	#4 – 3 AWG STR, #2 AWG SOL	#10	.55	1.05	.09	1.53	Gray	P29	8	29	1 1/8	50
LCB4-14F-L		1/4	.55	1.05	.09	1.53	Gray	P29	8	29	1 1/8	50
LCB2-10F-Q	#2 AWG	#10	.60	1.16	.10	1.75	Brown	P33	10	33	1 1/4	25
LCB2-56F-Q		5/16	.66	1.16	.10	1.74	Brown	P33	10	33	1 1/4	25
LCB1-10F-E	#1 AWG	#10	.70	1.36	.11	2.00	Green	P37	11	37	1 7/16	20
LCB1-56F-E		5/16	.70	1.36	.11	2.00	Green	P37	11	37	1 7/16	20
LCB1/0-10F-X		#10	.76	1.44	.12	2.15	Pink	P42	12	42	1 1/2	10
LCB1/0-56F-X	1/0 AWG	5/16	.76	1.44	.12	2.15	Pink	P42	12	42	1 1/2	10
LCB1/0-38F-X		3/8	.76	1.44	.12	2.15	Pink	P42	12	42	1 1/2	10
LCB1/0-12F-X		1/2	.80	1.44	.12	2.14	Pink	P42	12	42	1 1/2	10
LCB2/0-38F-X	2/0 AWG	3/8	.85	1.50	.13	2.30	Black	P45	13	45	1 9/16	10
LCB2/0-12F-X		1/2	.85	1.50	.13	2.30	Black	P45	13	45	1 9/16	10
LCB3/0-38F-X	3/0 AWG	3/8	.96	1.50	.13	2.35	Orange	P50	14	50	1 9/16	10
LCB3/0-12F-X		1/2	.96	1.50	.13	2.35	Orange	P50	14	50	1 9/16	10
LCB4/0-38F-X	4/0 AWG	3/8	1.06	1.56	.14	2.48	Purple	P54	15	54	1 5/8	10
LCB4/0-12F-X		1/2	1.06	1.56	.14	2.48	Purple	P54	15	54	1 5/8	10

‡See pages D3.58 – D3.61 for tool and die information.
 **Consult cable manufacturer for voltage stress relief instructions with applications greater than 2000 V.



Code Conductor, One-Hole, Long Barrel Lug, 90° Angle (continued)

Part Number	Copper Conductor Size	Stud Hole Size (In.)	Figure Dimensions (In.)				PANDUIT Color Code	PANDUIT Die Index No.‡	Burndy Die Index No.‡	T&B Die Index No.‡	Wire Strip Length (In.)	Std. Pkg. Qty.
			W	B	T	L						
LCB250-12F-X	250 kcmil	1/2	1.17	1.61	.14	2.57	Yellow	P62	16	62	1 11/16	10
LCB250-78F-X		7/8	1.25	1.61	.12	2.49	Yellow	P62	16	62	1 11/16	10
LCB300-56F-X	300 kcmil	5/16	1.19	2.24	.16	3.29	White	P66	17	66	2 5/16	10
LCB300-38F-X		3/8	1.19	2.24	.16	3.29	White	P66	17	66	2 5/16	10
LCB300-12F-X		1/2	1.19	2.24	.16	3.29	White	P66	17	66	2 5/16	10
LCB350-12F-X	350 kcmil	1/2	1.28	2.24	.17	3.34	Red	P71	18	71	2 5/16	10
LCB350-78F-X		7/8	1.28	2.24	.17	3.34	Red	P71	18	71	2 5/16	10
LCB400-12F-6	400 kcmil	1/2	1.39	2.30	.18	3.47	Blue	P76	19	76	2 3/8	6
LCB400-58F-6		5/8	1.39	2.30	.18	3.47	Blue	P76	19	76	2 3/8	6
LCB400-78F-6		7/8	1.39	2.30	.18	3.47	Blue	P76	19	76	2 3/8	6
LCB500-12F-6	500 kcmil	1/2	1.54	2.50	.22	3.77	Brown	P87	20	87	2 9/16	6
LCB500-58F-6		5/8	1.54	2.50	.22	3.77	Brown	P87	20	87	2 9/16	6
LCB500-78F-6		7/8	1.54	2.50	.22	3.77	Brown	P87	20	87	2 9/16	6
LCB600-12F-6	600 kcmil	1/2	1.70	2.69	.26	4.08	Green	P94	22	94	2 3/4	6
LCB600-58F-6		5/8	1.70	2.69	.26	4.08	Green	P94	22	94	2 3/4	6

‡See pages D3.58 – D3.61 for tool and die information.

**Consult cable manufacturer for voltage stress relief instructions with applications greater than 2000 V.

A.
System
Overview

B1.
Cable Ties

B2.
Cable
Accessories

B3.
Stainless
Steel Ties

C1.
Wiring
Duct

C2.
Surface
Raceway

C3.
Abrasion
Protection

C4.
Cable
Management

D1.
Terminals

D2.
Power
Connectors

D3.
Grounding
Connectors

E1.
Labeling
Systems

E2.
Labels

E3.
Pre-Printed
& Write-On
Markers

E4.
Permanent
Identification

E5.
Lockout/
Tagout
& Safety
Solutions

F.
Index

A. System Overview



Code Conductor, One-Hole, Long Barrel with Window Lug

B1. Cable Ties

For Use with Stranded Copper Conductors

Type LCB-W

- Long barrel maximizes number of crimps and provides premium wire pull-out strength and electrical performance
- Inspection window to visually assure full conductor insertion
- Color-coded barrels marked with *PANDUIT* and specified competitor die index numbers for proper crimp die selection
- Tin-plated to inhibit corrosion
- UL Listed and CSA Certified to 35 KV** and temperature rated to 90°C when crimped with *PANDUIT* and specified competitor crimping tools and dies

- UL Listed and CSA Certified for wide wire range-taking capability when crimped with *PANDUIT*® *UNI-DIE*™ Dieless Crimping Tools‡
- **Tested by Telcordia – meets NEBS Level 3**
- Meets J-STD-607-A and TIA-942 requirements for network systems grounding applications

C1. Wiring Duct

C2. Surface Raceway

C3. Abrasion Protection

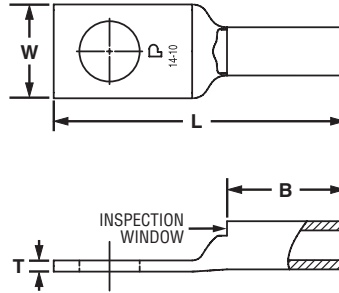

C4. Cable Management

D1. Terminals

D2. Power Connectors

D3. Grounding Connectors

Part Number	Copper Conductor Size	Stud Hole Size (In.)	Figure Dimensions (In.)				PANDUIT Color Code	PANDUIT Die Index No.‡	Burndy Die Index No.‡	T&B Die Index No.‡	Wire Strip Length (In.)	Std. Pkg. Qty.
			W	B	T	L						
LCB10-14W-L*	#14 – 10 AWG STR, #12 – 10 AWG SOL	1/4	.42	.53	.05	1.31	—	—	—	—	9/16	50
LCB750-38W-6	750 kcmil	3/8	1.89	2.88	.26	4.83	Black	P106	24	106	2 15/16	6
LCB750-12W-6		1/2	1.89	2.88	.26	5.03	Black	P106	24	106	2 15/16	6
LCB750-58W-6		5/8	1.89	2.88	.26	5.58	Black	P106	24	106	2 15/16	6
LCB750-78W-6		7/8	1.89	2.88	.26	5.68	Black	P106	24	106	2 15/16	6
LCB800-12W-6	800 kcmil	1/2	1.95	2.94	.30	5.11	Orange	P107	25	107	3	6
LCB800-58W-6		5/8	1.95	2.94	.30	5.68	Orange	P107	25	107	3	6
LCB1000-38W-3	1000 kcmil	3/8	2.17	3.00	.32	5.08	White	P125	27	125	3 1/16	3
LCB1000-12W-3		1/2	2.17	3.00	.32	5.27	White	P125	27	125	3 1/16	3
LCB1000-58W-3		5/8	2.17	3.00	.32	5.92	White	P125	27	125	3 1/16	3

‡See pages D3.58 – D3.61 for tool and die information.

*Not tested to NEBS Level 3 requirements.

**Consult cable manufacturer for voltage stress relief instructions with applications greater than 2000 V.

E1. Labeling Systems

E2. Labels

E3. Pre-Printed & Write-On Markers

E4. Permanent Identification

E5. Lockout/Tagout & Safety Solutions

F. Index

UL LISTED CERTIFIED Code Conductor, One-Hole, Long Barrel with Window Lug, 45° Angle

For Use with Stranded Copper Conductors

Type LCB-WH

- Long barrel maximizes number of crimps and provides premium wire pull-out strength and electrical performance
- Inspection window to visually assure full conductor insertion
- Tin-plated to inhibit corrosion
- UL Listed and CSA Certified to 35 KV** and temperature rated to 90°C when crimped with *PANDUIT* crimping tools and dies
- Meets J-STD-607-A and TIA-942 requirements for network systems grounding applications

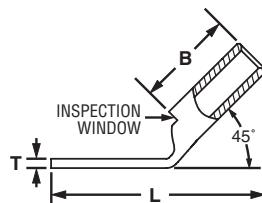
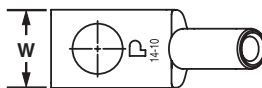

Part Number	Copper Conductor Size	Stud Hole Size (In.)	Figure Dimensions (In.)				PANDUIT Color Code	PANDUIT Die Index No.‡	Burndy Die Index No.‡	T&B Die Index No.‡	Wire Strip Length (In.)	Std. Pkg. Qty.
			W	B	T	L						
LCB10-14WH-L	#14 – 10 AWG STR, #12 – 10 AWG SOL	1/4	.42	.53	.05	1.15	—	—	—	—	9/16	50

‡See pages D3.58 – D3.61 for tool and die information.

**Consult cable manufacturer for voltage stress relief instructions with applications greater than 2000 V.

UL LISTED CERTIFIED Code Conductor, One-Hole, Long Barrel with Window Lug, 90° Angle

For Use with Stranded Copper Conductors

Type LCB-WF

- Long barrel maximizes number of crimps and provides premium wire pull-out strength and electrical performance
- Inspection window to visually assure full conductor insertion
- Tin-plated to inhibit corrosion
- UL Listed and CSA Certified to 35 KV** and temperature rated to 90°C when crimped with *PANDUIT* crimping tools and dies
- Meets J-STD-607-A and TIA-942 requirements for network systems grounding applications

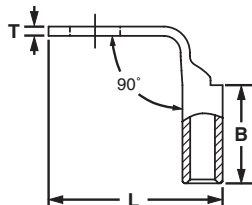

Part Number	Copper Conductor Size	Stud Hole Size (In.)	Figure Dimensions (In.)				PANDUIT Color Code	PANDUIT Die Index No.‡	Burndy Die Index No.‡	T&B Die Index No.‡	Wire Strip Length (In.)	Std. Pkg. Qty.
			W	B	T	L						
LCB10-14WF-L	#14 – 10 AWG STR, #12 – 10 AWG SOL	1/4	.42	.53	.05	.94	—	—	—	—	9/16	50

‡See pages D3.58 – D3.61 for tool and die information.

**Consult cable manufacturer for voltage stress relief instructions with applications greater than 2000 V.

A. System Overview

B1. Cable Ties

B2. Cable Accessories

B3. Stainless Steel Ties

C1. Wiring Duct

C2. Surface Raceway

C3. Abrasion Protection

C4. Cable Management

D1. Terminals

D2. Power Connectors

D3. Grounding Connectors

E1. Labeling Systems

E2. Labels

E3. Pre-Printed & Write-On Markers

E4. Permanent Identification

E5. Lockout/Tagout & Safety Solutions

F. Index

A. System Overview



Code Conductor, One-Hole, Long Barrel with Corona Relief Taper Lug

B1. Cable Ties

To Facilitate Use with Stranded Copper Conductors in Applications of 5000 V or More

Type LCBH

- Externally chamfered barrel end inhibits Corona effect when used in high voltage applications
- Long barrel maximizes number of crimps and provides premium wire pull-out strength and electrical performance
- Color-coded barrels marked with *PANDUIT* and specified competitor die index numbers for proper crimp die selection
- Enclosed barrel prevents corrosive material from entering barrel when used in harsh environments
- Tin-plated to inhibit corrosion
- UL Listed and CSA Certified to 35 KV** and temperature rated to 90°C when crimped with *PANDUIT* and specified competitor crimping tools and dies

B2. Cable Accessories

B3. Stainless Steel Ties



Corona Relief Taper

C1. Wiring Duct

C2. Surface Raceway

C3. Abrasion Protection

C4. Cable Management

D1. Terminals

D2. Power Connectors

D3. Grounding Connectors

E1. Labeling Systems

E2. Labels

E3. Pre-Printed & Write-On Markers

E4. Permanent Identification

E5. Lockout/Tagout & Safety Solutions

F. Index

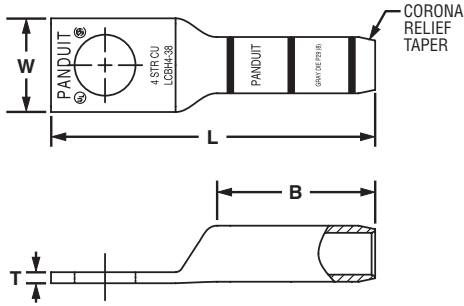

Part Number	Copper Conductor Size	Stud Hole Size (In.)	Figure Dimensions (In.)				PANDUIT Color Code	PANDUIT Die Index No. ‡	Burdny Die Index No. ‡	T&B Die Index No. ‡	Wire Strip Length (In.)	Std. Pkg. Qty.
			W	B	T	L						
LCBH4-38-L	#4 AWG	3/8	.62	1.05	.07	2.16	Gray	P29	8	29	1 1/8	50
LCBH2-38-Q	#2 AWG	3/8	.66	1.16	.10	2.34	Brown	P33	10	33	1 1/4	25
LCBH1-38-E	#1 AWG	3/8	.70	1.36	.10	2.57	Green	P37	11	37	1 7/16	20
LCBH1/0-38-X	1/0 AWG	3/8	.76	1.44	.12	2.69	Pink	P42	12	42	1 1/2	10
LCBH2/0-12-X	2/0 AWG	1/2	.85	1.50	.13	3.07	Black	P45	13	45	1 9/16	10
LCBH3/0-12-X	3/0 AWG	1/2	.96	1.50	.13	3.12	Orange	P50	14	50	1 9/16	10
LCBH4/0-12-X	4/0 AWG	1/2	1.06	1.56	.14	3.22	Purple	P54	15	54	1 5/8	10
LCBH250-12-X	250 kcmil	1/2	1.17	1.61	.14	3.32	Yellow	P62	16	62	1 11/16	10

‡See pages D3.62, D3.63 for tool and die information.

**Consult cable manufacturer for voltage stress relief instructions with applications greater than 2000 V.



Code Conductor, Two-Hole, Standard Barrel with Window Lug

For Use with Stranded Copper Conductors

Type LCD

- Color-coded barrels marked with *PANDUIT* and specified competitor die index numbers for proper crimp die selection
- Inspection window to visually assure full conductor insertion
- Tin-plated to inhibit corrosion
- UL Listed and CSA Certified to 35 KV** and temperature rated to 90°C when crimped with *PANDUIT* and specified competitor crimping tools and dies



- UL Listed and CSA Certified for wide wire range-taking capability when crimped with *PANDUIT*® *UNI-DIE*™ Dieless Crimping Tools‡
- **Tested by Telcordia – meets NEBS Level 3**
- American Bureau of Shipping approved
- Available with NEMA hole sizes and spacing

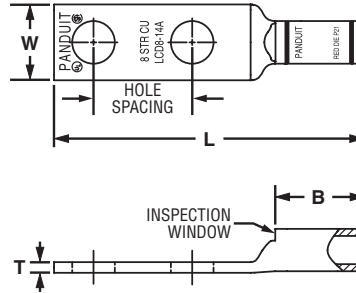

Part Number	Copper Conductor Size	Stud Hole Size (In.)	Stud Hole Spacing (In.)	Figure Dimensions (In.)				PANDUIT Color Code	PANDUIT Die Index No.‡	Burndy Die Index No.‡	T&B Die Index No.‡	Wire Strip Length (In.)	Std. Pkg. Qty.
				W	B	T	L						
LCD10-10A-L*	#14 – 10 AWG STR, #12 – 10 AWG SOL	#10	.63	.38	.38	.06	1.69	—	—	—	—	7/16	50
LCD10-14A-L*		1/4	.63	.42	.38	.05	1.78	—	—	—	—	7/16	50
LCD10-14B-L*		1/4	.75	.42	.38	.05	1.91	—	—	—	—	7/16	50
LCD10-14D-L*		1/4	1.00	.42	.38	.05	2.16	—	—	—	—	7/16	50
LCD10-38D-L*		3/8	1.00	.56	.38	.04	2.38	—	—	—	—	7/16	50
LCD8-10A-L	#8 AWG	#10	.63	.41	.56	.08	1.88	Red	P21	49	21	5/8	50
LCD8-14A-L		1/4	.63	.48	.56	.07	1.97	Red	P21	49	21	5/8	50
LCD8-14B-L		1/4	.75	.48	.56	.07	2.09	Red	P21	49	21	5/8	50
LCD8-14D-L		1/4	1.00	.48	.56	.07	2.34	Red	P21	49	21	5/8	50
LCD8-38D-L		3/8	1.00	.60	.56	.05	2.56	Red	P21	49	21	5/8	50
LCD6-10A-L	#6 AWG	#10	.63	.46	.81	.08	2.15	Blue	P24	7	24	7/8	50
LCD6-10B-L		#10	.75	.46	.81	.08	2.27	Blue	P24	7	24	7/8	50
LCD6-10D-L		#10	1.00	.46	.81	.08	2.52	Blue	P24	7	24	7/8	50
LCD6-14A-L		1/4	.63	.48	.81	.08	2.24	Blue	P24	7	24	7/8	50
LCD6-14B-L		1/4	.75	.48	.81	.08	2.36	Blue	P24	7	24	7/8	50
LCD6-14D-L		1/4	1.00	.48	.81	.08	2.61	Blue	P24	7	24	7/8	50
LCD6-56D-L		5/16	1.00	.56	.81	.07	2.73	Blue	P24	7	24	7/8	50
LCD6-38D-L		3/8	1.00	.62	.81	.06	2.83	Blue	P24	7	24	7/8	50
LCD4-10A-L		#4 – 3 AWG STR, #2 AWG SOL	#10	.63	.55	.81	.09	2.17	Gray	P29	8	29	7/8
LCD4-10B-L	#10		.75	.55	.81	.09	2.29	Gray	P29	8	29	7/8	50
LCD4-14A-L	1/4		.63	.55	.81	.09	2.26	Gray	P29	8	29	7/8	50
LCD4-14B-L	1/4		.75	.55	.81	.09	2.38	Gray	P29	8	29	7/8	50
LCD4-14D-L	1/4		1.00	.55	.81	.09	2.63	Gray	P29	8	29	7/8	50
LCD4-38D-L	3/8		1.00	.62	.81	.08	2.85	Gray	P29	8	29	7/8	50
LCD2-14A-Q	#2 AWG	1/4	.63	.60	.88	.10	2.40	Brown	P33	10	33	15/16	25
LCD2-14B-Q		1/4	.75	.60	.88	.10	2.52	Brown	P33	10	33	15/16	25
LCD2-14D-Q		1/4	1.00	.60	.88	.10	2.77	Brown	P33	10	33	15/16	25
LCD2-56B-Q		5/16	.75	.66	.88	.10	2.65	Brown	P33	10	33	15/16	25
LCD2-38D-Q		3/8	1.00	.66	.88	.10	3.00	Brown	P33	10	33	15/16	25
LCD2-12-Q		1/2	1.75	.75	.88	.08	4.14	Brown	P33	10	33	15/16	25

‡See pages D3.54 – D3.57 for tool and die information.

*Not tested to NEBS Level 3 requirements.

**Consult cable manufacturer for voltage stress relief instructions with applications greater than 2000 V.

Table continues on page D2.32

A. System Overview

B1. Cable Ties

B2. Cable Accessories

B3. Stainless Steel Ties

C1. Wiring Duct

C2. Surface Raceway

C3. Abrasion Protection

C4. Cable Management

D1. Terminals

D2. Power Connectors

D3. Grounding Connectors

E1. Labeling Systems

E2. Labels

E3. Pre-Printed & Write-On Markers

E4. Permanent Identification

E5. Lockout/Tagout & Safety Solutions

F. Index

A.
System
Overview



Code Conductor, Two-Hole, Standard Barrel with Window Lug (continued)

B1.
Cable Ties

B2.
Cable
Accessories

B3.
Stainless
Steel Ties

C1.
Wiring
Duct

C2.
Surface
Raceway

C3.
Abrasion
Protection

C4.
Cable
Management

D1.
Terminals

D2.
Power
Connectors

D3.
Grounding
Connectors

E1.
Labeling
Systems

E2.
Labels

E3.
Pre-Printed
& Write-On
Markers

E4.
Permanent
Identification

E5.
Lockout/
Tagout
& Safety
Solutions

F.
Index

Part Number	Copper Conductor Size	Stud Hole Size (In.)	Stud Hole Spacing (In.)	Figure Dimensions (In.)				PANDUIT Color Code	PANDUIT Die Index No.‡	Burndy Die Index No.‡	T&B Die Index No.‡	Wire Strip Length (In.)	Std. Pkg. Qty.	
				W	B	T	L							
LCD1-14A-E	#1 AWG	1/4	.63	.70	.88	.11	2.42	Green	P37	11	37	15/16	20	
LCD1-14B-E		1/4	.75	.70	.88	.11	2.54	Green	P37	11	37	15/16	20	
LCD1-56C-E		5/16	.88	.70	.88	.11	2.79	Green	P37	11	37	15/16	20	
LCD1-38D-E		3/8	1.00	.70	.88	.11	2.99	Green	P37	11	37	15/16	20	
LCD1-12-E		1/2	1.75	.75	.88	.09	4.16	Green	P37	11	37	15/16	20	
LCD1/0-14A-X		1/0 AWG	1/4	.63	.76	.94	.12	2.57	Pink	P42	12	42	1	10
LCD1/0-14B-X	1/4		.75	.76	.94	.12	2.70	Pink	P42	12	42	1	10	
LCD1/0-56C-X	5/16		.88	.76	.94	.12	2.88	Pink	P42	12	42	1	10	
LCD1/0-38D-X	3/8		1.00	.76	.94	.12	3.08	Pink	P42	12	42	1	10	
LCD1/0-12-X	1/2		1.75	.80	.94	.12	4.25	Pink	P42	12	42	1	10	
LCD2/0-14A-X	2/0 AWG		1/4	.63	.85	.98	.13	2.70	Black	P45	13	45	1 1/16	10
LCD2/0-14B-X		1/4	.75	.85	.98	.13	2.83	Black	P45	13	45	1 1/16	10	
LCD2/0-56C-X		5/16	.88	.85	.98	.13	2.95	Black	P45	13	45	1 1/16	10	
LCD2/0-38D-X		3/8	1.00	.85	.98	.13	3.14	Black	P45	13	45	1 1/16	10	
LCD2/0-12-X		1/2	1.75	.85	.98	.13	4.30	Black	P45	13	45	1 1/16	10	
LCD3/0-14B-X		3/0 AWG	1/4	.75	.96	1.14	.13	3.02	Orange	P50	14	50	1 3/16	10
LCD3/0-56D-X	5/16		1.00	.96	1.14	.13	3.27	Orange	P50	14	50	1 3/16	10	
LCD3/0-38D-X	3/8		1.00	.96	1.14	.13	3.33	Orange	P50	14	50	1 3/16	10	
LCD3/0-12-X	1/2		1.75	.96	1.14	.13	4.49	Orange	P50	14	50	1 3/16	10	
LCD4/0-14B-X	4/0 AWG		1/4	.75	1.06	1.19	.14	3.10	Purple	P54	15	54	1 1/4	10
LCD4/0-38D-X			3/8	1.00	1.06	1.19	.14	3.44	Purple	P54	15	54	1 1/4	10
◆ LCD4/0-12-X		1/2	1.75	1.06	1.19	.14	4.58	Purple	P54	15	54	1 1/4	10	
LCD250-38D-X		250 kcmil	3/8	1.00	1.17	1.25	.14	3.54	Yellow	P62	16	62	1 5/16	10
◆ LCD250-12-X			1/2	1.75	1.17	1.25	.14	4.68	Yellow	P62	16	62	1 5/16	10
LCD300-38D-X		300 kcmil	3/8	1.00	1.19	1.44	.16	3.74	White	P66	17	66	1 1/2	10
◆ LCD300-12-X	1/2		1.75	1.19	1.44	.16	4.92	White	P66	17	66	1 1/2	10	
LCD350-14B-X	350 kcmil	1/4	.75	1.28	1.44	.17	3.30	Red	P71	18	71	1 1/2	10	
LCD350-38D-X		3/8	1.00	1.28	1.44	.17	3.78	Red	P71	18	71	1 1/2	10	
LCD350-12E-X		1/2	1.25	1.28	1.44	.17	4.33	Red	P71	18	71	1 1/2	10	
◆ LCD350-12-X		1/2	1.75	1.28	1.44	.17	4.96	Red	P71	18	71	1 1/2	10	
LCD400-38D-6		400 kcmil	3/8	1.00	1.39	1.50	.18	3.86	Blue	P76	19	76	1 9/16	6
◆ LCD400-12-6			1/2	1.75	1.39	1.50	.18	5.04	Blue	P76	19	76	1 9/16	6
LCD500-14B-6	500 kcmil	1/4	.75	1.54	1.75	.22	3.71	Brown	P87	20	87	1 13/16	6	
LCD500-38D-6		3/8	1.00	1.54	1.75	.22	4.19	Brown	P87	20	87	1 13/16	6	
LCD500-12E-6		1/2	1.25	1.54	1.75	.22	4.74	Brown	P87	20	87	1 13/16	6	
◆ LCD500-12-6		1/2	1.75	1.54	1.75	.22	5.37	Brown	P87	20	87	1 13/16	6	
LCD600-38D-6		600 kcmil	3/8	1.00	1.70	1.75	.26	4.24	Green	P94	22	94	1 13/16	6
◆ LCD600-12-6			1/2	1.75	1.70	1.75	.26	5.42	Green	P94	22	94	1 13/16	6
LCD750-38D-6	750 kcmil	3/8	1.00	1.89	1.88	.26	4.71	Black	P106	24	106	1 15/16	6	
◆ LCD750-12-6		1/2	1.75	1.89	1.88	.26	5.65	Black	P106	24	106	1 15/16	6	
LCD750-58G-6	750 kcmil	5/8	1.50	1.89	1.88	.26	5.46	Black	P106	24	106	1 15/16	6	
◆ LCD1000-12-3	1000 kcmil	1/2	1.75	2.17	1.88	.32	5.77	White	P125	27	125	1 15/16	3	
LCD1000-12E-3		1/2	1.25	2.17	1.88	.32	5.27	White	P125	27	125	1 15/16	3	

‡See pages D3.54 – D3.57 for tool and die information.

**Consult cable manufacturer for voltage stress relief instructions with applications greater than 2000 V.

◆NEMA hole sizes and spacing.



Code Conductor, Two-Hole, Standard Barrel with Window Lug, 45° Angle

For Use with Stranded Copper Conductors

Type LCD-H

- Color-coded barrels marked with *PANDUIT* and specified competitor die index numbers for proper crimp die selection
- Inspection window to visually assure full conductor insertion
- Tin-plated to inhibit corrosion
- UL Listed and CSA Certified to 35 KV** and temperature rated to 90°C when crimped with *PANDUIT* and specified competitor crimping tools and dies

- UL Listed and CSA Certified for wide wire range-taking capability when crimped with *PANDUIT*® *UNI-DIE*™ Dieless Crimping Tools‡
- **Tested by Telcordia – meets NEBS Level 3**
- American Bureau of Shipping approved
- Available with NEMA hole sizes and spacing

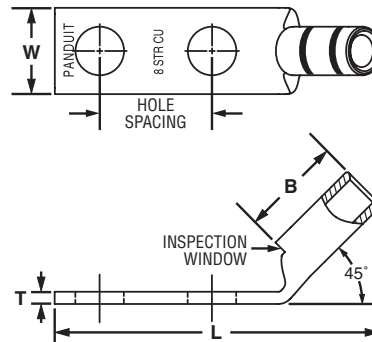

Part Number	Copper Conductor Size	Stud Hole Size (In.)	Stud Hole Spacing (In.)	Figure Dimensions (In.)				PANDUIT Color Code	PANDUIT Die Index No.‡	Burndy Die Index No.‡	T&B Die Index No.‡	Wire Strip Length (In.)	Std. Pkg. Qty.
				W	B	T	L						
LCD10-10AH-L*	#14 – 10	#10	.63	.38	.38	.06	1.59	—	—	—	—	7/16	50
LCD10-14AH-L*	AWG STR, #12 – 10	1/4	.63	.42	.38	.05	1.67	—	—	—	—	7/16	50
LCD10-38DH-L*	AWG SOL	3/8	1.00	.56	.38	.04	2.28	—	—	—	—	7/16	50
LCD8-10AH-L	#8 AWG	#10	.63	.41	.56	.08	1.73	Red	P21	49	21	5/8	50
LCD8-14AH-L		1/4	.63	.48	.56	.07	1.81	Red	P21	49	21	5/8	50
LCD8-14BH-L		1/4	.75	.48	.56	.07	1.94	Red	P21	49	21	5/8	50
LCD8-14DH-L		1/4	1.00	.48	.56	.07	2.19	Red	P21	49	21	5/8	50
LCD8-38DH-L		3/8	1.00	.63	.56	.05	2.40	Red	P21	49	21	5/8	50
LCD6-10AH-L	#6 AWG	#10	.63	.46	.81	.08	1.92	Blue	P24	7	24	7/8	50
LCD6-10BH-L		#10	.75	.46	.81	.08	2.04	Blue	P24	7	24	7/8	50
LCD6-10DH-L		#10	1.00	.46	.81	.08	2.29	Blue	P24	7	24	7/8	50
LCD6-14AH-L		1/4	.63	.48	.81	.08	2.00	Blue	P24	7	24	7/8	50
LCD6-14BH-L		1/4	.75	.48	.81	.08	2.13	Blue	P24	7	24	7/8	50
LCD6-14DH-L		1/4	1.00	.48	.81	.08	2.38	Blue	P24	7	24	7/8	50
LCD6-56DH-L		5/16	1.00	.56	.81	.07	2.49	Blue	P24	7	24	7/8	50
LCD6-38DH-L	3/8	1.00	.62	.81	.06	2.59	Blue	P24	7	24	7/8	50	
LCD4-10AH-L	#4 – 3 AWG STR, #2 AWG SOL	#10	.63	.55	.81	.09	1.94	Gray	P29	8	29	7/8	50
LCD4-10BH-L		#10	.75	.55	.81	.09	2.06	Gray	P29	8	29	7/8	50
LCD4-14AH-L		1/4	.63	.55	.81	.09	2.03	Gray	P29	8	29	7/8	50
LCD4-14BH-L		1/4	.75	.55	.81	.09	2.15	Gray	P29	8	29	7/8	50
LCD4-14DH-L		1/4	1.00	.55	.81	.09	2.40	Gray	P29	8	29	7/8	50
LCD4-38DH-L		3/8	1.00	.62	.81	.08	2.62	Gray	P29	8	29	7/8	50

‡See pages D3.54 – D3.57 for tool and die information.

*Not tested to NEBS Level 3 requirements.

**Consult cable manufacturer for voltage stress relief instructions with applications greater than 2000 V.

Table continues on page D2.34

A. System Overview

B1. Cable Ties

B2. Cable Accessories

B3. Stainless Steel Ties

C1. Wiring Duct

C2. Surface Raceway

C3. Abrasion Protection

C4. Cable Management

D1. Terminals

D2. Power Connectors

D3. Grounding Connectors

E1. Labeling Systems

E2. Labels

E3. Pre-Printed & Write-On Markers

E4. Permanent Identification

E5. Lockout/Tagout & Safety Solutions

F. Index

A. System Overview



Code Conductor, Two-Hole, Standard Barrel with Window Lug, 45° Angle (continued)

B1. Cable Ties

B2. Cable Accessories

B3. Stainless Steel Ties

C1. Wiring Duct

C2. Surface Raceway

C3. Abrasion Protection

C4. Cable Management

D1. Terminals

D2. Power Connectors

D3. Grounding Connectors

E1. Labeling Systems

E2. Labels

E3. Pre-Printed & Write-On Markers

E4. Permanent Identification

E5. Lockout/Tagout & Safety Solutions

F. Index

Part Number	Copper Conductor Size	Stud Hole Size (In.)	Stud Hole Spacing (In.)	Figure Dimensions (In.)				PANDUIT Color Code	PANDUIT Die Index No.‡	Burndy Die Index No.‡	T&B Die Index No.‡	Wire Strip Length (In.)	Std. Pkg. Qty.	
				W	B	T	L							
LCD2-14AH-Q	#2 AWG	1/4	.63	.60	.88	.10	2.11	Brown	P33	10	33	15/16	25	
LCD2-14BH-Q		1/4	.75	.60	.88	.10	2.24	Brown	P33	10	33	15/16	25	
LCD2-14DH-Q		1/4	1.00	.60	.88	.10	2.49	Brown	P33	10	33	15/16	25	
LCD2-56BH-Q		5/16	.75	.66	.88	.10	2.36	Brown	P33	10	33	15/16	25	
LCD2-38DH-Q		3/8	1.00	.66	.88	.10	2.71	Brown	P33	10	33	15/16	25	
LCD2-12H-Q		1/2	1.75	.75	.88	.08	3.84	Brown	P33	10	33	15/16	25	
LCD1-14AH-E	#1 AWG	1/4	.63	.70	.88	.11	2.12	Green	P37	11	37	15/16	20	
LCD1-14BH-E		1/4	.75	.70	.88	.11	2.25	Green	P37	11	37	15/16	20	
LCD1-56CH-E		5/16	.88	.70	.88	.11	2.50	Green	P37	11	37	15/16	20	
LCD1-38DH-E		3/8	1.00	.70	.88	.11	2.70	Green	P37	11	37	15/16	20	
LCD1-12H-E		1/2	1.75	.75	.88	.09	3.87	Green	P37	11	37	15/16	20	
LCD1/0-14AH-X		1/0 AWG	1/4	.63	.76	.94	.12	2.26	Pink	P42	12	42	1	10
LCD1/0-14BH-X	1/4		.75	.76	.94	.12	2.38	Pink	P42	12	42	1	10	
LCD1/0-56CH-X	5/16		.88	.76	.94	.12	2.56	Pink	P42	12	42	1	10	
LCD1/0-38DH-X	3/8		1.00	.76	.94	.12	2.76	Pink	P42	12	42	1	10	
LCD1/0-12H-X	1/2		1.75	.80	.94	.12	3.93	Pink	P42	12	42	1	10	
LCD2/0-14AH-X	2/0 AWG		1/4	.63	.85	.98	.13	2.39	Black	P45	13	45	1 1/16	10
LCD2/0-14BH-X		1/4	.75	.85	.98	.13	2.52	Black	P45	13	45	1 1/16	10	
LCD2/0-56CH-X		5/16	.88	.85	.98	.13	2.64	Black	P45	13	45	1 1/16	10	
LCD2/0-38DH-X		3/8	1.00	.85	.98	.13	2.83	Black	P45	13	45	1 1/16	10	
LCD2/0-12H-X		1/2	1.75	.85	.98	.13	3.99	Black	P45	13	45	1 1/16	10	
LCD3/0-14BH-X		3/0 AWG	1/4	.75	.96	1.14	.13	2.65	Orange	P50	14	50	1 3/16	10
LCD3/0-56DH-X	5/16		1.00	.96	1.14	.13	2.90	Orange	P50	14	50	1 3/16	10	
LCD3/0-38DH-X	3/8		1.00	.96	1.14	.13	2.96	Orange	P50	14	50	1 3/16	10	
LCD3/0-12H-X	1/2		1.75	.96	1.14	.13	4.12	Orange	P50	14	50	1 3/16	10	
LCD4/0-14BH-X	4/0 AWG		1/4	.75	1.06	1.19	.14	2.72	Purple	P54	15	54	1 1/4	10
LCD4/0-38DH-X			3/8	1.00	1.06	1.19	.14	3.05	Purple	P54	15	54	1 1/4	10
LCD4/0-12H-X		1/2	1.75	1.06	1.19	.14	4.19	Purple	P54	15	54	1 1/4	10	
LCD250-38DH-X		250 kcmil	3/8	1.00	1.17	1.25	.14	3.13	Yellow	P62	16	62	1 5/16	10
LCD250-12H-X			1/2	1.75	1.17	1.25	.14	4.27	Yellow	P62	16	62	1 5/16	10
LCD300-38DH-X		300 kcmil	3/8	1.00	1.17	1.44	.14	3.36	White	P66	17	66	1 1/2	10
LCD300-12H-X	1/2		1.75	1.17	1.44	.14	4.54	White	P66	17	66	1 1/2	10	
LCD350-14BH-X	350 kcmil	1/4	.75	1.28	1.44	.17	2.92	Red	P71	18	71	1 1/2	10	
LCD350-38DH-X		3/8	1.00	1.28	1.44	.17	3.40	Red	P71	18	71	1 1/2	10	
LCD350-12EH-X		1/2	1.25	1.28	1.44	.17	3.95	Red	P71	18	71	1 1/2	10	
LCD350-12H-X		1/2	1.75	1.28	1.44	.17	4.58	Red	P71	18	71	1 1/2	10	
LCD400-38DH-6		400 kcmil	3/8	1.00	1.39	1.50	.18	3.50	Blue	P76	19	76	1 9/16	6
LCD400-12H-6			1/2	1.75	1.39	1.50	.18	4.68	Blue	P76	19	76	1 9/16	6
LCD500-14BH-6	500 kcmil	1/4	.75	1.54	1.75	.22	3.27	Brown	P87	20	87	1 13/16	6	
LCD500-38DH-6		3/8	1.00	1.54	1.75	.22	3.75	Brown	P87	20	87	1 13/16	6	
LCD500-12EH-6		1/2	1.25	1.54	1.75	.22	4.30	Brown	P87	20	87	1 13/16	6	
LCD500-12H-6		1/2	1.75	1.54	1.75	.22	4.93	Brown	P87	20	87	1 13/16	6	
LCD600-38DH-6		600 kcmil	3/8	1.00	1.70	1.75	.26	3.81	Green	P94	22	94	1 13/16	6
LCD600-12H-6			1/2	1.75	1.70	1.75	.26	4.99	Green	P94	22	94	1 13/16	6

‡See pages D3.54 – D3.57 for tool and die information.

**Consult cable manufacturer for voltage stress relief instructions with applications greater than 2000 V.

◆NEMA hole sizes and spacing.



Code Conductor, Two-Hole, Standard Barrel with Window Lug, 90° Angle

For Use with Stranded Copper Conductors

Type LCD-F

- Color-coded barrels marked with *PANDUIT* and specified competitor die index numbers for proper crimp die selection
- Inspection window to visually assure full conductor insertion
- Tin-plated to inhibit corrosion
- UL Listed and CSA Certified to 35 KV** and temperature rated to 90°C when crimped with *PANDUIT* and specified competitor crimping tools and dies

- UL Listed and CSA Certified for wide wire range-taking capability when crimped with *PANDUIT*® *UNI-DIE*™ Dieless Crimping Tools‡
- **Tested by Telcordia – meets NEBS Level 3**
- American Bureau of Shipping approved
- Available with NEMA hole sizes and spacing

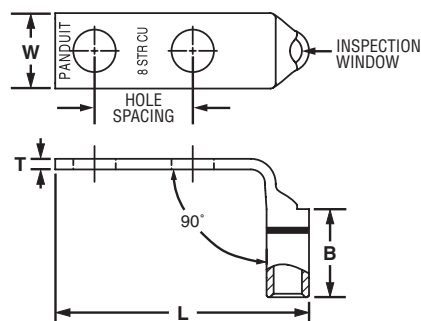

Part Number	Copper Conductor Size	Stud Hole Size (In.)	Stud Hole Spacing (In.)	Figure Dimensions (In.)				PANDUIT Color Code	PANDUIT Die Index No.‡	Burdny Die Index No.‡	T&B Die Index No.‡	Wire Strip Length (In.)	Std. Pkg. Qty.
				W	B	T	L						
LCD10-10AF-L*	#14 – 10 AWG STR, #12 – 10 AWG SOL	#10	.63	.38	.38	.06	1.47	—	—	—	—	7/16	50
LCD10-14AF-L*		1/4	.63	.42	.38	.05	1.56	—	—	—	—	7/16	50
LCD10-38DF-L*		3/8	1.00	.56	.38	.04	2.16	—	—	—	—	7/16	50
LCD8-10AF-L	#8 AWG	#10	.63	.41	.56	.08	1.53	Red	P21	49	21	5/8	50
LCD8-14AF-L		1/4	.63	.48	.56	.07	1.62	Red	P21	49	21	5/8	50
LCD8-14BF-L		1/4	.75	.48	.56	.07	1.74	Red	P21	49	21	5/8	50
LCD8-14DF-L		1/4	1.00	.48	.56	.07	1.99	Red	P21	49	21	5/8	50
LCD8-38DF-L		3/8	1.00	.63	.56	.05	2.21	Red	P21	49	21	5/8	50
LCD6-10AF-L	#6 AWG	#10	.63	.46	.81	.08	1.57	Blue	P24	7	24	7/8	50
LCD6-10BF-L		#10	.75	.46	.81	.08	1.69	Blue	P24	7	24	7/8	50
LCD6-10DF-L		#10	1.00	.46	.81	.08	1.94	Blue	P24	7	24	7/8	50
LCD6-14AF-L		1/4	.63	.48	.81	.08	1.66	Blue	P24	7	24	7/8	50
LCD6-14BF-L		1/4	.75	.48	.81	.08	1.78	Blue	P24	7	24	7/8	50
LCD6-14DF-L		1/4	1.00	.48	.81	.08	2.03	Blue	P24	7	24	7/8	50
LCD6-56DF-L		5/16	1.00	.56	.81	.07	2.15	Blue	P24	7	24	7/8	50
LCD6-38DF-L		3/8	1.00	.62	.81	.06	2.25	Blue	P24	7	24	7/8	50
LCD4-10AF-L	#4 – 3 AWG STR, #2 AWG SOL	#10	.63	.55	.81	.09	1.65	Gray	P29	8	29	7/8	50
LCD4-10BF-L		#10	.75	.55	.81	.09	1.78	Gray	P29	8	29	7/8	50
LCD4-14AF-L		1/4	.63	.55	.81	.09	1.74	Gray	P29	8	29	7/8	50
LCD4-14BF-L		1/4	.75	.55	.81	.09	1.87	Gray	P29	8	29	7/8	50
LCD4-14DF-L		1/4	1.00	.55	.81	.09	2.12	Gray	P29	8	29	7/8	50
LCD4-38DF-L		3/8	1.00	.62	.81	.08	2.34	Gray	P29	8	29	7/8	50
LCD2-14AF-Q	#2 AWG	1/4	.63	.60	.88	.10	1.86	Brown	P33	10	33	15/16	25
LCD2-14BF-Q		1/4	.75	.60	.88	.10	1.99	Brown	P33	10	33	15/16	25
LCD2-14DF-Q		1/4	1.00	.60	.88	.10	2.24	Brown	P33	10	33	15/16	25
LCD2-56BF-Q		5/16	.75	.66	.88	.10	2.11	Brown	P33	10	33	15/16	25
LCD2-38DF-Q		3/8	1.00	.66	.88	.10	2.47	Brown	P33	10	33	15/16	25
LCD2-12F-Q		1/2	1.75	.75	.88	.08	3.61	Brown	P33	10	33	15/16	25

‡See pages D3.54 – D3.57 for tool and die information.

*Not tested to NEBS Level 3 requirements.

**Consult cable manufacturer for voltage stress relief instructions with applications greater than 2000 V.

Table continues on page D2.36

A. System Overview

B1. Cable Ties

B2. Cable Accessories

B3. Stainless Steel Ties

C1. Wiring Duct

C2. Surface Raceway

C3. Abrasion Protection

C4. Cable Management

D1. Terminals

D2. Power Connectors

D3. Grounding Connectors

E1. Labeling Systems

E2. Labels

E3. Pre-Printed & Write-On Markers

E4. Permanent Identification

E5. Lockout/Tagout & Safety Solutions

F. Index

A.
System
Overview



Code Conductor, Two-Hole, Standard Barrel with Window Lug, 90° Angle (continued)

B1.
Cable Ties

B2.
Cable
Accessories

B3.
Stainless
Steel Ties

C1.
Wiring
Duct

C2.
Surface
Raceway

C3.
Abrasion
Protection

C4.
Cable
Management

D1.
Terminals

D2.
Power
Connectors

D3.
Grounding
Connectors

E1.
Labeling
Systems

E2.
Labels

E3.
Pre-Printed
& Write-On
Markers

E4.
Permanent
Identification

E5.
Lockout/
Tagout
& Safety
Solutions

F.
Index

Part Number	Copper Conductor Size	Stud Hole Size (In.)	Stud Hole Spacing (In.)	Figure Dimensions (In.)				PANDUIT Color Code	PANDUIT Die Index No.‡	Burndy Die Index No.‡	T&B Die Index No.‡	Wire Strip Length (In.)	Std. Pkg. Qty.
				W	B	T	L						
LCD1-14AF-E	#1 AWG	1/4	.63	.70	.88	.11	1.94	Green	P37	11	37	15/16	20
LCD1-14BF-E		1/4	.75	.70	.88	.11	2.06	Green	P37	11	37	15/16	20
LCD1-56CF-E		5/16	.88	.70	.88	.11	2.31	Green	P37	11	37	15/16	20
LCD1-38DF-E		3/8	1.00	.70	.88	.11	2.51	Green	P37	11	37	15/16	20
LCD1-12F-E		1/2	1.75	.75	.88	.09	3.68	Green	P37	11	37	15/16	20
LCD1/0-14AF-X	1/0 AWG	1/4	.63	.76	.94	.12	2.08	Pink	P42	12	42	1	10
LCD1/0-14BF-X		1/4	.75	.76	.94	.12	2.20	Pink	P42	12	42	1	10
LCD1/0-56CF-X		5/16	.88	.76	.94	.12	2.38	Pink	P42	12	42	1	10
LCD1/0-38DF-X		3/8	1.00	.76	.94	.12	2.58	Pink	P42	12	42	1	10
LCD1/0-12F-X	2/0 AWG	1/2	1.75	.80	.94	.12	3.75	Pink	P42	12	42	1	10
LCD2/0-14AF-X		1/4	.63	.85	.98	.13	2.22	Black	P45	13	45	1 1/16	10
LCD2/0-14BF-X		1/4	.75	.85	.98	.13	2.34	Black	P45	13	45	1 1/16	10
LCD2/0-56CF-X		5/16	.88	.85	.98	.13	2.47	Black	P45	13	45	1 1/16	10
LCD2/0-38DF-X		3/8	1.00	.85	.98	.13	2.66	Black	P45	13	45	1 1/16	10
LCD2/0-12F-X	3/0 AWG	1/2	1.75	.85	.98	.13	3.82	Black	P45	13	45	1 1/16	10
LCD3/0-14BF-X		1/4	.75	.96	1.14	.13	2.42	Orange	P50	14	50	1 3/16	10
LCD3/0-56DF-X		5/16	1.00	.96	1.14	.13	2.67	Orange	P50	14	50	1 3/16	10
LCD3/0-38DF-X		3/8	1.00	.96	1.14	.13	2.73	Orange	P50	14	50	1 3/16	10
LCD3/0-12F-X	4/0 AWG	1/2	1.75	.96	1.14	.13	3.89	Orange	P50	14	50	1 3/16	10
LCD4/0-14BF-X		1/4	.75	1.06	1.19	.14	2.50	Purple	P54	15	54	1 1/4	10
LCD4/0-38DF-X		3/8	1.00	1.06	1.19	.14	2.84	Purple	P54	15	54	1 1/4	10
◆ LCD4/0-12F-X	250 kcmil	1/2	1.75	1.06	1.19	.14	3.98	Purple	P54	15	54	1 1/4	10
◆ LCD250-38DF-X		3/8	1.00	1.17	1.25	.14	2.90	Yellow	P62	16	62	1 5/16	10
◆ LCD250-12F-X	300 kcmil	1/2	1.75	1.17	1.25	.14	4.04	Yellow	P62	16	62	1 5/16	10
◆ LCD300-38DF-X		3/8	1.00	1.19	1.44	.16	2.88	White	P66	17	66	1 1/2	10
◆ LCD300-12F-X	350 kcmil	1/2	1.75	1.19	1.44	.16	4.06	White	P66	17	66	1 1/2	10
LCD350-14BF-X		1/4	.75	1.28	1.44	.17	2.46	Red	P71	18	71	1 1/2	10
LCD350-38DF-X		3/8	1.00	1.28	1.44	.17	2.94	Red	P71	18	71	1 1/2	10
◆ LCD350-12EF-X	400 kcmil	1/2	1.25	1.28	1.44	.17	3.49	Red	P71	18	71	1 1/2	10
◆ LCD350-12F-X		1/2	1.75	1.28	1.44	.17	4.12	Red	P71	18	71	1 1/2	10
LCD400-38DF-6	500 kcmil	3/8	1.00	1.39	1.50	.18	3.02	Blue	P76	19	76	1 9/16	6
◆ LCD400-12F-6		1/2	1.75	1.39	1.50	.18	4.20	Blue	P76	19	76	1 9/16	6
LCD500-14BF-6	600 kcmil	1/4	.75	1.54	1.75	.22	2.65	Brown	P87	20	87	1 13/16	6
LCD500-38DF-6		3/8	1.00	1.54	1.75	.22	3.13	Brown	P87	20	87	1 13/16	6
LCD500-12EF-6		1/2	1.25	1.54	1.75	.22	3.68	Brown	P87	20	87	1 13/16	6
◆ LCD500-12F-6	600 kcmil	1/2	1.75	1.54	1.75	.22	4.31	Brown	P87	20	87	1 13/16	6
LCD600-38DF-6		3/8	1.00	1.70	1.75	.26	3.26	Green	P94	22	94	1 13/16	6
◆ LCD600-12F-6		1/2	1.75	1.70	1.75	.26	4.44	Green	P94	22	94	1 13/16	6

‡See pages D3.54 – D3.57 for tool and die information.

**Consult cable manufacturer for voltage stress relief instructions with applications greater than 2000 V.

◆NEMA hole sizes and spacing.



Code Conductor, Two-Hole, Standard Barrel with Window, Narrow Tongue Lug

For Use with Stranded Copper Conductors

Type LCDN

- Narrow tongue width for limited space applications
- Color-coded barrels marked with **PANDUIT** and specified competitor die index numbers for proper crimp die selection
- Inspection window to visually assure full conductor insertion
- Tin-plated to inhibit corrosion
- UL Listed and CSA Certified to 35 KV** and temperature rated to 90°C when crimped with **PANDUIT** and specified competitor crimping tools and dies
- UL Listed and CSA Certified for wide wire range-taking capability when crimped with **PANDUIT® UNI-DIE™** Dieless Crimping Tools‡

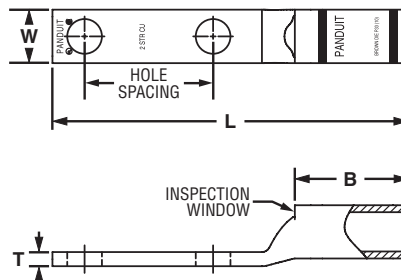

Part Number	Copper Conductor Size	Stud Hole Size (In.)	Stud Hole Spacing (In.)	Figure Dimensions (In.)				PANDUIT Color Code	PANDUIT Die Index No.‡	Burdny Die Index No.‡	T&B Die Index No.‡	Wire Strip Length (In.)	Std. Pkg. Qty.
				W	B	T	L						
LCDN2-14A-Q	#2 AWG	1/4	.63	.42	.88	.11	2.40	Brown	P33	10	33	15/16	25
LCDN2-14B-Q		1/4	.75	.42	.88	.11	2.52	Brown	P33	10	33	15/16	25
LCDN2-14D-Q		1/4	1.00	.42	.88	.11	2.77	Brown	P33	10	33	15/16	25
LCDN1-14B-E	#1 AWG	1/4	.75	.47	.88	.11	2.54	Green	P37	11	37	15/16	20
LCDN1/0-14D-X	1/0 AWG	1/4	1.00	.52	.94	.13	2.95	Pink	P42	12	42	1	10
LCDN1/0-56D-X		5/16	1.00	.52	.94	.13	3.00	Pink	P42	12	42	1	10
LCDN2/0-14A-X	2/0 AWG	1/4	.63	.58	.98	.13	2.71	Black	P45	13	45	1 1/16	10
LCDN2/0-14D-X		1/4	1.00	.58	.98	.13	3.09	Black	P45	13	45	1 1/16	10
LCDN2/0-56A-X		5/16	.63	.58	.98	.13	2.71	Black	P45	13	45	1 1/16	10
LCDN2/0-56D-X		5/16	1.00	.58	.98	.13	3.09	Black	P45	13	45	1 1/16	10
LCDN350-38D-X	350 kcmil	3/8	1.00	.88	1.44	.17	3.79	Red	P71	18	71	1 1/2	10
LCDN500-38D-6	500 kcmil	3/8	1.00	1.06	1.75	.22	4.20	Brown	P87	20	87	1 13/16	6
LCDN500-12D-6		1/2	1.00	1.06	1.75	.22	4.63	Brown	P87	20	87	1 13/16	6
LCDN750-38D-6	750 kcmil	3/8	1.00	1.30	1.88	.26	4.72	Black	P106	24	106	1 15/16	6
LCDN750-12D-6		1/2	1.00	1.30	1.88	.26	4.91	Black	P106	24	106	1 15/16	6

‡See pages D3.54 – D3.57 for tool and die information.

**Consult cable manufacturer for voltage stress relief instructions with applications greater than 2000 V.

A. System Overview

B1. Cable Ties

B2. Cable Accessories

B3. Stainless Steel Ties

C1. Wiring Duct

C2. Surface Raceway

C3. Abrasion Protection

C4. Cable Management

D1. Terminals

D2. Power Connectors

D3. Grounding Connectors

E1. Labeling Systems

E2. Labels

E3. Pre-Printed & Write-On Markers

E4. Permanent Identification

E5. Lockout/Tagout & Safety Solutions

F. Index

A.
System
Overview



Code Conductor, Two-Hole, Standard Barrel with Window, Narrow Tongue Lug, 45°

B1.
Cable Ties

For Use with Stranded Copper Conductors

Type LCDN-H

- Narrow tongue width for limited space applications
- Color-coded barrels marked with *PANDUIT* and specified competitor die index numbers for proper crimp die selection
- Inspection window to visually assure full conductor insertion
- Tin-plated to inhibit corrosion

- UL Listed and CSA Certified to 35 KV** and temperature rated to 90°C when crimped with *PANDUIT* and specified competitor crimping tools and dies
- UL Listed and CSA Certified for wide wire range-taking capability when crimped with *PANDUIT*® *UNI-DIE*™ Dieless Crimping Tools‡

B2.
Cable
Accessories

B3.
Stainless
Steel Ties

C1.
Wiring
Duct

C2.
Surface
Raceway

C3.
Abrasion
Protection

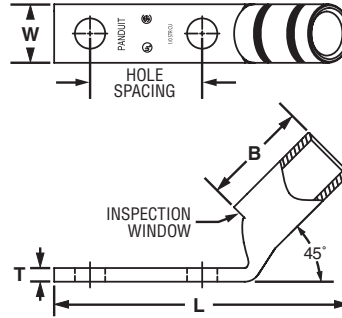

C4.
Cable
Management

Part Number	Copper Conductor Size	Stud Hole Size (In.)	Stud Hole Spacing (In.)	Figure Dimensions (In.)				PANDUIT Color Code	PANDUIT Die Index No.‡	Burndy Die Index No.‡	T&B Die Index No.‡	Wire Strip Length (In.)	Std. Pkg. Qty.
				W	B	T	L						
LCDN2-14AH-Q	#2 AWG	1/4	.63	.42	.88	.11	2.12	Brown	P33	10	33	15/16	25
LCDN2-14DH-Q	#2 AWG	1/4	1.00	.42	.88	.11	2.49	Brown	P33	10	33	15/16	25
LCDN1/0-14DH-X	1/0 AWG	1/4	1.00	.52	.94	.13	2.63	Pink	P42	12	42	1	10
LCDN1/0-56DH-X	1/0 AWG	5/16	1.00	.52	.94	.13	2.70	Pink	P42	12	42	1	10
LCDN750-38DH-6	750 kcmil	3/8	1.00	1.30	1.88	.26	4.25	Black	P106	24	106	1 15/16	6
LCDN750-12DH-6	750 kcmil	1/2	1.00	1.30	1.88	.26	4.43	Black	P106	24	106	1 15/16	6

‡See pages D3.54 – D3.57 for tool and die information.

**Consult cable manufacturer for voltage stress relief instructions with applications greater than 2000 V.

D1.
Terminals

D2.
Power
Connectors

D3.
Grounding
Connectors

E1.
Labeling
Systems

E2.
Labels

E3.
Pre-Printed
& Write-On
Markers

E4.
Permanent
Identification

E5.
Lockout/
Tagout/
& Safety
Solutions

F.
Index



Code Conductor, Two-Hole, Standard Barrel with Window, Narrow Tongue Lug, 90°

For Use with Stranded Copper Conductors

Type LCDN-F

- Narrow tongue width for limited space applications
- Color-coded barrels marked with *PANDUIT* and specified competitor die index numbers for proper crimp die selection
- Inspection window to visually assure full conductor insertion
- Tin-plated to inhibit corrosion

- UL Listed and CSA Certified to 35 KV** and temperature rated to 90°C when crimped with *PANDUIT* and specified competitor crimping tools and dies
- UL Listed and CSA Certified for wide wire range-taking capability when crimped with *PANDUIT*® *UNI-DIE*™ Dieless Crimping Tools‡

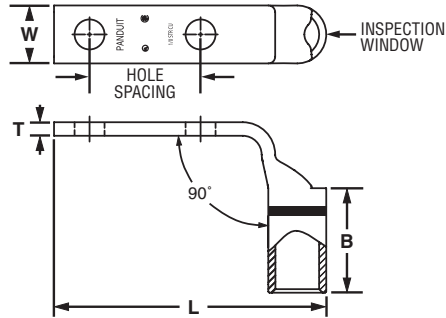

Part Number	Copper Conductor Size	Stud Hole Size (In.)	Stud Hole Spacing (In.)	Figure Dimensions (In.)				PANDUIT Color Code	PANDUIT Die Index No.‡	Burndy Die Index No.‡	T&B Die Index No.‡	Wire Strip Length (In.)	Std. Pkg. Qty.
				W	B	T	L						
LCDN2-14AF-Q	#2 AWG	1/4	.63	.42	.88	.11	1.86	Brown	P33	10	33	15/16	25
LCDN2-14DF-Q	#2 AWG	1/4	1.00	.42	.88	.11	2.24	Brown	P33	10	33	15/16	25
LCDN1/0-14DF-X	1/0 AWG	1/4	1.00	.52	.94	.13	2.45	Pink	P42	12	42	1	10
LCDN1/0-56DF-X	1/0 AWG	5/16	1.00	.52	.94	.13	2.51	Pink	P42	12	42	1	10
LCDN750-38DF-6	750 kcmil	3/8	1.00	1.30	1.88	.26	3.56	Black	P106	24	106	1 15/16	6
LCDN750-12DF-6	750 kcmil	1/2	1.00	1.30	1.88	.26	3.75	Black	P106	24	106	1 15/16	6

‡See pages D3.54 – D3.57 for tool and die information.

**Consult cable manufacturer for voltage stress relief instructions with applications greater than 2000 V.

A.
System Overview

B1.
Cable Ties

B2.
Cable Accessories

B3.
Stainless Steel Ties

C1.
Wiring Duct

C2.
Surface Raceway

C3.
Abrasion Protection

C4.
Cable Management

D1.
Terminals

D2.
Power Connectors

D3.
Grounding Connectors

E1.
Labeling Systems

E2.
Labels

E3.
Pre-Printed & Write-On Markers

E4.
Permanent Identification

E5.
Lockout/Tagout & Safety Solutions

F.
Index

A.
System
Overview



Code Conductor, Long Blank Tongue, Standard Barrel with Window Lug

B1.
Cable Ties

For Use with Stranded Copper Conductors

Type LCD-00

- Color-coded barrels marked with *PANDUIT* and specified competitor die index numbers for proper crimp die selection
- Inspection window to visually assure full conductor insertion
- Tin-plated to inhibit corrosion
- UL Recognized and CSA Certified to 35 KV** and temperature rated to 90°C when crimped with *PANDUIT* and specified competitor crimping tools and dies

B2.
Cable
Accessories

B3.
Stainless
Steel Ties

C1.
Wiring
Duct

C2.
Surface
Raceway

C3.
Abrasion
Protection

C4.
Cable
Management

D1.
Terminals

D2.
Power
Connectors

D3.
Grounding
Connectors

E1.
Labeling
Systems

E2.
Labels

E3.
Pre-Printed
& Write-On
Markers

E4.
Permanent
Identification

E5.
Lockout/
Tagout/
& Safety
Solutions

F.
Index

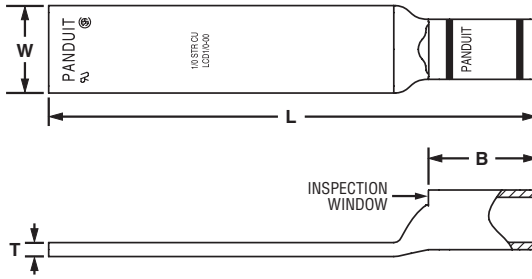

Part Number	Copper Conductor Size	Figure Dimensions (In.)				PANDUIT Color Code	PANDUIT Die Index No.‡	Burdy Die Index No.‡	T&B Die Index No.‡	Wire Strip Length (In.)	Std. Pkg. Qty.
		W	B	T	L						
LCD1/0-00-X	1/0 AWG	.76	.94	.12	4.25	Pink	P42	12	42	1	10
LCD2/0-00-X	2/0 AWG	.85	.98	.13	4.30	Black	P45	13	45	1 1/16	10
LCD3/0-00-X	3/0 AWG	.96	1.14	.13	4.50	Orange	P50	14	50	1 3/16	10
LCD4/0-00-X	4/0 AWG	1.06	1.19	.14	4.58	Purple	P54	15	54	1 1/4	10
LCD250-00-X	250 kcmil	1.17	1.25	.14	4.69	Yellow	P62	16	62	1 5/16	10
LCD300-00-X	300 kcmil	1.19	1.44	.16	4.93	White	P66	17	66	1 1/2	10
LCD350-00-X	350 kcmil	1.28	1.44	.17	4.97	Red	P71	18	71	1 1/2	10
LCD400-00-6	400 kcmil	1.39	1.50	.18	5.05	Blue	P76	19	76	1 9/16	6
LCD500-00-6	500 kcmil	1.54	1.75	.22	5.38	Brown	P87	20	87	1 13/16	6
LCD600-00-6	600 kcmil	1.70	1.75	.26	5.43	Green	P94	22	94	1 13/16	6
LCD750-00-6	750 kcmil	1.89	1.88	.26	5.65	Black	P106	24	106	1 15/16	6
LCD1000-00-3	1000 kcmil	2.17	1.88	.32	5.77	White	P125	27	125	1 15/16	3

‡See pages D3.54 – D3.57 for tool and die information.

**Consult cable manufacturer for voltage stress relief instructions with applications greater than 2000 V.

UL LISTED CERTIFIED Code Conductor, Two-Hole, Long Barrel Lug

For Use with Stranded Copper Conductors

Type LCC

- Long barrel maximizes number of crimps and provides premium wire pull-out strength and electrical performance
- Color-coded barrels marked with *PANDUIT* and specified competitor die index numbers for proper crimp die selection
- Enclosed barrel prevents corrosive material from entering barrel when used in harsh environments
- Tin-plated to inhibit corrosion
- UL Listed and CSA Certified to 35 KV** and temperature rated to 90°C when crimped with *PANDUIT* and specified competitor crimping tools and dies
- UL Listed and CSA Certified for wide wire range-taking capability when crimped with *PANDUIT*® *UNI-DIE*™ Dieless Crimping Tools‡
- **Tested by Telcordia – meets NEBS Level 3**
- American Bureau of Shipping approved
- Available with NEMA hole sizes and spacing

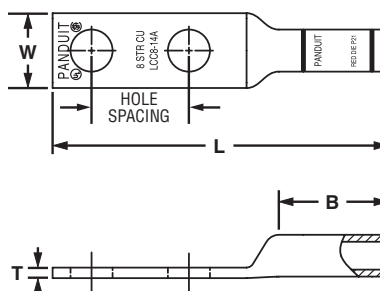

Part Number	Copper Conductor Size	Stud Hole Size (In.)	Stud Hole Spacing (In.)	Figure Dimensions (In.)				PANDUIT Color Code	PANDUIT Die Index No.‡	Burdny Die Index No.‡	T&B Die Index No.‡	Wire Strip Length (In.)	Std. Pkg. Qty.
				W	B	T	L						
LCC8-10A-L	#8 AWG	#10	.63	.41	.70	.08	2.07	Red	P21	49	21	3/4	50
LCC8-14A-L		1/4	.63	.48	.70	.07	2.16	Red	P21	49	21	3/4	50
LCC8-14B-L		1/4	.75	.48	.70	.07	2.28	Red	P21	49	21	3/4	50
LCC8-14D-L		1/4	1.00	.48	.70	.07	2.53	Red	P21	49	21	3/4	50
LCC8-38D-L		3/8	1.00	.60	.70	.05	2.75	Red	P21	49	21	3/4	50
LCC6-10A-L		#6 AWG	#10	.63	.46	1.07	.08	2.47	Blue	P24	7	24	1 1/8
LCC6-14A-L	1/4		.63	.48	1.07	.08	2.56	Blue	P24	7	24	1 1/8	50
LCC6-14B-L	1/4		.75	.48	1.07	.08	2.68	Blue	P24	7	24	1 1/8	50
LCC6-14D-L	1/4		1.00	.48	1.07	.08	2.93	Blue	P24	7	24	1 1/8	50
LCC6-38D-L	3/8		1.00	.62	1.07	.06	3.15	Blue	P24	7	24	1 1/8	50
LCC6-12-L	1/2		1.75	.81	1.13	.16	4.48	Blue	P24	7	24	1 3/16	50
LCC4-14A-L	#4 – 3 AWG STR, #2 AWG SOL	1/4	.63	.55	1.05	.09	2.58	Gray	P29	8	29	1 1/8	50
LCC4-14B-L		1/4	.75	.55	1.05	.09	2.70	Gray	P29	8	29	1 1/8	50
LCC4-38D-L		3/8	1.00	.62	1.05	.08	3.17	Gray	P29	8	29	1 1/8	50
LCC4-12-L		1/2	1.75	.84	1.13	.16	4.50	Gray	P29	8	29	1 1/16	50
LCC2-14A-Q	#2 AWG	1/4	.63	.60	1.16	.10	2.77	Brown	P33	10	33	1 1/4	25
LCC2-14B-Q		1/4	.75	.60	1.16	.10	2.89	Brown	P33	10	33	1 1/4	25
LCC2-56B-Q		5/16	.75	.66	1.16	.10	3.02	Brown	P33	10	33	1 1/4	25
LCC2-56C-Q		5/16	.88	.66	1.16	.10	3.14	Brown	P33	10	33	1 1/4	25
LCC2-38D-Q		3/8	1.00	.66	1.16	.10	3.34	Brown	P33	10	33	1 1/4	25
LCC2-38-Q		3/8	1.75	.66	1.16	.10	4.09	Brown	P33	10	33	1 1/4	25
LCC2-12-Q		1/2	1.75	.75	1.16	.08	4.51	Brown	P33	10	33	1 1/4	25
LCC1-14A-E		#1 AWG	1/4	.63	.70	1.36	.11	3.00	Green	P37	11	37	1 7/16
LCC1-14B-E	1/4		.75	.70	1.36	.11	3.12	Green	P37	11	37	1 7/16	20
LCC1-56B-E	5/16		.75	.70	1.36	.11	3.25	Green	P37	11	37	1 7/16	20
LCC1-56C-E	5/16		.88	.70	1.36	.11	3.37	Green	P37	11	37	1 7/16	20
LCC1-38D-E	3/8		1.00	.70	1.36	.11	3.57	Green	P37	11	37	1 7/16	20
LCC1-12-E	1/2		1.75	.75	1.36	.09	4.74	Green	P37	11	37	1 7/16	20

‡See pages D3.58 – D3.61 for tool and die information.

**Consult cable manufacturer for voltage stress relief instructions with applications greater than 2000 V.

Table continues on page D2.42

A. System Overview

B1. Cable Ties

B2. Cable Accessories

B3. Stainless Steel Ties

C1. Wiring Duct

C2. Surface Raceway

C3. Abrasion Protection

C4. Cable Management

D1. Terminals

D2. Power Connectors

D3. Grounding Connectors

E1. Labeling Systems

E2. Labels

E3. Pre-Printed & Write-On Markers

E4. Permanent Identification

E5. Lockout/Tagout & Safety Solutions

F. Index

A. System Overview



Code Conductor, Two-Hole, Long Barrel Lug (continued)

B1. Cable Ties

B2. Cable Accessories

B3. Stainless Steel Ties

C1. Wiring Duct

C2. Surface Raceway

C3. Abrasion Protection

C4. Cable Management

D1. Terminals

D2. Power Connectors

D3. Grounding Connectors

E1. Labeling Systems

E2. Labels

E3. Pre-Printed & Write-On Markers

E4. Permanent Identification

E5. Lockout/Tagout & Safety Solutions

F. Index

Part Number	Copper Conductor Size	Stud Hole Size (In.)	Stud Hole Spacing (In.)	Figure Dimensions (In.)				PANDUIT Color Code	PANDUIT Die Index No.‡	Burndy Die Index No.‡	T&B Die Index No.‡	Wire Strip Length (In.)	Std. Pkg. Qty.	
				W	B	T	L							
LCC1/0-14A-X	1/0 AWG	1/4	.63	.76	1.44	.12	3.18	Pink	P42	12	42	1 1/2	10	
LCC1/0-14B-X		1/4	.75	.76	1.44	.12	3.31	Pink	P42	12	42	1 1/2	10	
LCC1/0-56C-X		5/16	.88	.76	1.44	.12	3.49	Pink	P42	12	42	1 1/2	10	
LCC1/0-56D-X		5/16	1.00	.76	1.44	.12	3.61	Pink	P42	12	42	1 1/2	10	
LCC1/0-38D-X		3/8	1.00	.76	1.44	.12	3.69	Pink	P42	12	42	1 1/2	10	
LCC1/0-12D-X		1/2	1.00	.80	1.44	.12	3.95	Pink	P42	12	42	1 1/2	10	
LCC1/0-12-X		1/2	1.75	.80	1.44	.12	4.86	Pink	P42	12	42	1 1/2	10	
LCC2/0-14A-X		2/0 AWG	1/4	.63	.85	1.50	.13	3.38	Black	P45	13	45	1 9/16	10
LCC2/0-14B-X			1/4	.75	.85	1.50	.13	3.51	Black	P45	13	45	1 9/16	10
LCC2/0-56D-X			5/16	1.00	.85	1.50	.13	3.76	Black	P45	13	45	1 9/16	10
LCC2/0-38D-X	3/8		1.00	.85	1.50	.13	3.82	Black	P45	13	45	1 9/16	10	
LCC2/0-12D-X	1/2		1.00	.85	1.50	.13	4.07	Black	P45	13	45	1 9/16	10	
LCC2/0-12-X	1/2		1.75	.85	1.50	.13	4.98	Black	P45	13	45	1 9/16	10	
LCC3/0-14B-X	3/0 AWG		1/4	.75	.96	1.50	.13	3.56	Orange	P50	14	50	1 9/16	10
LCC3/0-38D-X			3/8	1.00	.96	1.50	.13	3.87	Orange	P50	14	50	1 9/16	10
LCC3/0-12D-X			1/2	1.00	.96	1.50	.13	4.12	Orange	P50	14	50	1 9/16	10
LCC3/0-12-X			1/2	1.75	.96	1.50	.13	5.03	Orange	P50	14	50	1 9/16	10
LCC4/0-14B-X		4/0 AWG	1/4	.75	1.06	1.56	.14	3.66	Purple	P54	15	54	1 5/8	10
LCC4/0-56D-X	5/16		1.00	1.06	1.56	.14	3.92	Purple	P54	15	54	1 5/8	10	
LCC4/0-38D-X	3/8		1.00	1.06	1.56	.14	3.99	Purple	P54	15	54	1 5/8	10	
LCC4/0-38-X	3/8		1.75	1.06	1.56	.14	4.74	Purple	P54	15	54	1 5/8	10	
LCC4/0-12D-X	1/2		1.00	1.06	1.56	.14	4.22	Purple	P54	15	54	1 5/8	10	
◆ LCC4/0-12-X	1/2		1.75	1.06	1.56	.14	5.13	Purple	P54	15	54	1 5/8	10	
LCC250-38D-X	250 kcmil		3/8	1.00	1.17	1.60	.14	4.09	Yellow	P62	16	62	1 11/16	10
LCC250-12D-X		1/2	1.00	1.17	1.60	.14	4.32	Yellow	P62	16	62	1 11/16	10	
◆ LCC250-12-X		1/2	1.75	1.17	1.60	.14	5.23	Yellow	P62	16	62	1 11/16	10	
LCC300-38D-X	300 kcmil	3/8	1.00	1.19	2.24	.16	4.76	White	P66	17	66	2 5/16	10	
◆ LCC300-12-X		1/2	1.75	1.19	2.24	.16	5.94	White	P66	17	66	2 5/16	10	
LCC350-14B-X	350 kcmil	1/4	.75	1.28	2.24	.17	4.33	Red	P71	18	71	2 5/16	10	
LCC350-38D-X		3/8	1.00	1.28	2.24	.17	4.81	Red	P71	18	71	2 5/16	10	
◆ LCC350-12-X		1/2	1.75	1.28	2.24	.17	5.99	Red	P71	18	71	2 5/16	10	
LCC400-14B-6	400 kcmil	1/4	.75	1.39	2.30	.18	4.44	Blue	P76	19	76	2 3/8	6	
LCC400-38D-6		3/8	1.00	1.39	2.30	.18	4.92	Blue	P76	19	76	2 3/8	6	
◆ LCC400-12-6		1/2	1.75	1.39	2.30	.18	6.10	Blue	P76	19	76	2 3/8	6	
LCC500-14B-6	500 kcmil	1/4	.75	1.54	2.50	.22	4.70	Brown	P87	20	87	2 9/16	6	
LCC500-38D-6		3/8	1.00	1.54	2.50	.22	5.18	Brown	P87	20	87	2 9/16	6	
◆ LCC500-12-6		1/2	1.75	1.54	2.50	.22	6.36	Brown	P87	20	87	2 9/16	6	
LCC600-38D-6	600 kcmil	3/8	1.00	1.70	2.69	.26	5.45	Green	P94	22	94	2 3/4	6	
◆ LCC600-12-6		1/2	1.75	1.70	2.69	.26	6.63	Green	P94	22	94	2 3/4	6	
LCC750-38D-6	750 kcmil	3/8	1.00	1.89	2.87	.26	6.10	Black	P106	24	106	2 15/16	6	
◆ LCC750-12-6		1/2	1.75	1.89	2.87	.26	7.04	Black	P106	24	106	2 15/16	6	
◆ LCC800-12-6	800 kcmil	1/2	1.75	1.95	2.94	.29	7.13	Orange	P107	25	—	3	6	
LCC1000-38D-3	1000 kcmil	3/8	1.00	2.17	3.00	.32	6.35	White	P125	27	125	3 1/16	3	
◆ LCC1000-12-3		1/2	1.75	2.17	3.00	.32	7.29	White	P125	27	125	3 1/16	3	

‡See pages D3.58 – D3.61 for tool and die information.

**Consult cable manufacturer for voltage stress relief instructions with applications greater than 2000 V.

◆NEMA hole sizes and spacing.



Code Conductor, Two-Hole, Long Barrel Lug, 45° Angle

For Use with Stranded Copper Conductors

Type LCC-H

- Long barrel maximizes number of crimps and provides premium wire pull-out strength and electrical performance
- Color-coded barrels marked with *PANDUIT* and specified competitor die index numbers for proper crimp die selection
- Enclosed barrel prevents corrosive material from entering barrel when used in harsh environments
- Tin-plated to inhibit corrosion
- UL Listed and CSA Certified to 35 KV** and temperature rated to 90°C when crimped with *PANDUIT* and specified competitor crimping tools and dies
- UL Listed and CSA Certified for wide wire range-taking capability when crimped with *PANDUIT*® *UNI-DIE*™ Dieless Crimping Tools‡
- **Tested by Telcordia – meets NEBS Level 3**
- American Bureau of Shipping approved
- Available with NEMA hole sizes and spacing

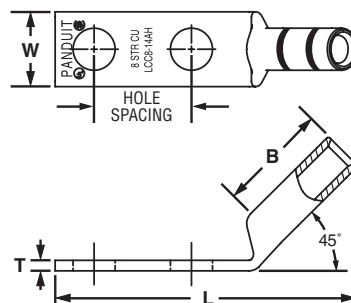

Part Number	Copper Conductor Size	Stud Hole Size (In.)	Stud Hole Spacing (In.)	Figure Dimensions (In.)				PANDUIT Color Code	PANDUIT Die Index No.‡	Burdny Die Index No.‡	T&B Die Index No.‡	Wire Strip Length (In.)	Std. Pkg. Qty.
				W	B	T	L						
LCC8-10AH-L	#8 AWG	#10	.63	.41	.70	.08	1.86	Red	P21	49	21	3/4	50
LCC8-14AH-L		1/4	.63	.48	.70	.07	1.94	Red	P21	49	21	3/4	50
LCC8-14BH-L		1/4	.75	.48	.70	.07	2.06	Red	P21	49	21	3/4	50
LCC8-14DH-L		1/4	1.00	.48	.70	.07	2.31	Red	P21	49	21	3/4	50
LCC8-38DH-L		3/8	1.00	.60	.70	.05	2.52	Red	P21	49	21	3/4	50
LCC6-10AH-L	#6 AWG	#10	.63	.46	1.07	.08	2.14	Blue	P24	7	24	1 1/8	50
LCC6-14AH-L		1/4	.63	.48	1.07	.08	2.23	Blue	P24	7	24	1 1/8	50
LCC6-14BH-L		1/4	.75	.48	1.07	.08	2.35	Blue	P24	7	24	1 1/8	50
LCC6-14DH-L		1/4	1.00	.48	1.07	.08	2.60	Blue	P24	7	24	1 1/8	50
LCC6-38DH-L		3/8	1.00	.62	1.07	.06	2.81	Blue	P24	7	24	1 1/8	50
LCC4-14AH-L	#4 – 3 AWG STR, #2 AWG SOL	1/4	.63	.55	1.05	.09	2.26	Gray	P29	8	29	1 1/8	50
LCC4-14BH-L		1/4	.75	.55	1.05	.09	2.38	Gray	P29	8	29	1 1/8	50
LCC4-38DH-L		3/8	1.00	.62	1.05	.08	2.84	Gray	P29	8	29	1 1/8	50
LCC2-14AH-Q	#2 AWG	1/4	.63	.60	1.16	.10	2.38	Brown	P33	10	33	1 1/4	25
LCC2-14BH-Q		1/4	.75	.60	1.16	.10	2.50	Brown	P33	10	33	1 1/4	25
LCC2-56BH-Q		5/16	.75	.66	1.16	.10	2.62	Brown	P33	10	33	1 1/4	25
LCC2-56CH-Q		5/16	.88	.66	1.16	.10	2.75	Brown	P33	10	33	1 1/4	25
LCC2-38DH-Q		3/8	1.00	.66	1.16	.10	2.95	Brown	P33	10	33	1 1/4	25
LCC2-38H-Q		3/8	1.75	.66	1.16	.10	3.70	Brown	P33	10	33	1 1/4	25
LCC2-12H-Q		1/2	1.75	.75	1.16	.08	4.10	Brown	P33	10	33	1 1/4	25

‡See pages D3.58 – D3.61 for tool and die information.

**Consult cable manufacturer for voltage stress relief instructions with applications greater than 2000 V.

◆NEMA hole sizes and spacing.

Table continues on page D2.44

A. System Overview

B1. Cable Ties

B2. Cable Accessories

B3. Stainless Steel Ties

C1. Wiring Duct

C2. Surface Raceway

C3. Abrasion Protection

C4. Cable Management

D1. Terminals

D2. Power Connectors

D3. Grounding Connectors

E1. Labeling Systems

E2. Labels

E3. Pre-Printed & Write-On Markers

E4. Permanent Identification

E5. Lockout/Tagout & Safety Solutions

F. Index

A. System Overview



Code Conductor, Two-Hole, Long Barrel Lug, 45° Angle (continued)

B1. Cable Ties

B2. Cable Accessories

B3. Stainless Steel Ties

C1. Wiring Duct

C2. Surface Raceway

C3. Abrasion Protection

C4. Cable Management

D1. Terminals

D2. Power Connectors

D3. Grounding Connectors

E1. Labeling Systems

E2. Labels

E3. Pre-Printed & Write-On Markers

E4. Permanent Identification

E5. Lockout/Tagout & Safety Solutions

F. Index

Part Number	Copper Conductor Size	Stud Hole Size (In.)	Stud Hole Spacing (In.)	Figure Dimensions (In.)				PANDUIT Color Code	PANDUIT Die Index No.‡	Burdny Die Index No.‡	T&B Die Index No.‡	Wire Strip Length (In.)	Std. Pkg. Qty.
				W	B	T	L						
LCC1-14AH-E	#1 AWG	1/4	.63	.70	1.36	.11	2.53	Green	P37	11	37	1 7/16	20
LCC1-14BH-E		1/4	.75	.70	1.36	.11	2.66	Green	P37	11	37	1 7/16	20
LCC1-56BH-E		5/16	.75	.70	1.36	.11	2.78	Green	P37	11	37	1 7/16	20
LCC1-56CH-E		5/16	.88	.70	1.36	.11	2.91	Green	P37	11	37	1 7/16	20
LCC1-38DH-E		3/8	1.00	.70	1.36	.11	3.11	Green	P37	11	37	1 7/16	20
LCC1-12H-E		1/2	1.75	.75	1.36	.09	4.27	Green	P37	11	37	1 7/16	20
LCC1/0-14AH-X	1/0 AWG	1/4	.63	.76	1.44	.12	2.69	Pink	P42	12	42	1 1/2	10
LCC1/0-14BH-X		1/4	.75	.76	1.44	.12	2.81	Pink	P42	12	42	1 1/2	10
LCC1/0-56CH-X		5/16	.88	.76	1.44	.12	2.99	Pink	P42	12	42	1 1/2	10
LCC1/0-56DH-X		5/16	1.00	.76	1.44	.12	3.12	Pink	P42	12	42	1 1/2	10
LCC1/0-38DH-X		3/8	1.00	.76	1.44	.12	3.19	Pink	P42	12	42	1 1/2	10
LCC1/0-12DH-X		1/2	1.00	.80	1.44	.12	3.46	Pink	P42	12	42	1 1/2	10
LCC1/0-12H-X	1/2	1.75	.80	1.44	.12	4.36	Pink	P42	12	42	1 1/2	10	
LCC2/0-14AH-X	2/0 AWG	1/4	.63	.85	1.50	.13	2.87	Black	P45	13	45	1 9/16	10
LCC2/0-14BH-X		1/4	.75	.85	1.50	.13	2.99	Black	P45	13	45	1 9/16	10
LCC2/0-56DH-X		5/16	1.00	.85	1.50	.13	3.24	Black	P45	13	45	1 9/16	10
LCC2/0-38DH-X		3/8	1.00	.85	1.50	.13	3.31	Black	P45	13	45	1 9/16	10
LCC2/0-12DH-X		1/2	1.00	.85	1.50	.13	3.56	Black	P45	13	45	1 9/16	10
LCC2/0-12H-X		1/2	1.75	.85	1.50	.13	4.47	Black	P45	13	45	1 9/16	10
LCC3/0-14BH-X	3/0 AWG	1/4	.75	.96	1.50	.13	3.02	Orange	P50	14	50	1 9/16	10
LCC3/0-38DH-X		3/8	1.00	.96	1.50	.13	3.33	Orange	P50	14	50	1 9/16	10
LCC3/0-12DH-X		1/2	1.00	.96	1.50	.13	3.58	Orange	P50	14	50	1 9/16	10
LCC3/0-12H-X		1/2	1.75	.96	1.50	.13	4.50	Orange	P50	14	50	1 9/16	10
LCC4/0-14BH-X	4/0 AWG	1/4	.75	1.06	1.56	.14	3.11	Purple	P54	15	54	1 5/8	10
LCC4/0-56DH-X		5/16	1.00	1.06	1.56	.14	3.37	Purple	P54	15	54	1 5/8	10
LCC4/0-38DH-X		3/8	1.00	1.06	1.56	.14	3.44	Purple	P54	15	54	1 5/8	10
LCC4/0-38H-X		3/8	1.75	1.06	1.56	.14	4.19	Purple	P54	15	54	1 5/8	10
LCC4/0-12DH-X		1/2	1.00	1.06	1.56	.14	3.67	Purple	P54	15	54	1 5/8	10
LCC4/0-12H-X		1/2	1.75	1.06	1.56	.14	4.58	Purple	P54	15	54	1 5/8	10
LCC250-38DH-X	250 kcmil	3/8	1.00	1.17	1.61	.14	3.51	Yellow	P62	16	62	1 11/16	10
LCC250-12DH-X		1/2	1.00	1.17	1.61	.14	3.74	Yellow	P62	16	62	1 11/16	10
LCC250-12H-X	300 kcmil	1/2	1.75	1.17	1.61	.14	4.65	Yellow	P62	16	62	1 11/16	10
LCC300-38DH-X		3/8	1.00	1.19	2.24	.16	4.05	White	P66	17	66	2 5/16	10
LCC300-12H-X	350 kcmil	1/2	1.75	1.19	2.24	.16	5.23	White	P66	17	66	2 5/16	10
LCC350-14BH-X		1/4	.75	1.28	2.24	.17	3.61	Red	P71	18	71	2 5/16	10
LCC350-38DH-X		3/8	1.00	1.28	2.24	.17	4.09	Red	P71	18	71	2 5/16	10
LCC350-12H-X	400 kcmil	1/2	1.75	1.28	2.24	.17	5.27	Red	P71	18	71	2 5/16	10
LCC400-14BH-6		1/4	.75	1.39	2.30	.18	3.70	Blue	P76	19	76	2 3/8	6
LCC400-38DH-6		3/8	1.00	1.39	2.30	.18	4.18	Blue	P76	19	76	2 3/8	6
LCC400-12H-6	500 kcmil	1/2	1.75	1.39	2.30	.18	5.36	Blue	P76	19	76	2 3/8	6
LCC500-14BH-6		1/4	.75	1.54	2.50	.22	3.91	Brown	P87	20	87	2 9/16	6
LCC500-38DH-6		3/8	1.00	1.54	2.50	.22	4.39	Brown	P87	20	87	2 9/16	6
LCC500-12H-6	600 kcmil	1/2	1.75	1.54	2.50	.22	5.57	Brown	P87	20	87	2 9/16	6
LCC600-38DH-6		3/8	1.00	1.70	2.69	.26	4.61	Green	P94	22	94	2 3/4	6
LCC600-12H-6	1/2	1.75	1.70	2.69	.26	5.79	Green	P94	22	94	2 3/4	6	

‡See pages D3.58 – D3.61 for tool and die information.

**Consult cable manufacturer for voltage stress relief instructions with applications greater than 2000 V.

◆NEMA hole sizes and spacing.

UL LISTED CERTIFIED Code Conductor, Two-Hole, Long Barrel Lug, 90° Angle

For Use with Stranded Copper Conductors

Type LCC-F

- Long barrel maximizes number of crimps and provides premium wire pull-out strength and electrical performance
- Color-coded barrels marked with *PANDUIT* and specified competitor die index numbers for proper crimp die selection
- Enclosed barrel prevents corrosive material from entering barrel when used in harsh environments
- Tin-plated to inhibit corrosion
- UL Listed and CSA Certified to 35 KV** and temperature rated to 90°C when crimped with *PANDUIT* and specified competitor crimping tools and dies
- UL Listed and CSA Certified for wide wire range-taking capability when crimped with *PANDUIT*® *UNI-DIE*™ Dieless Crimping Tools‡
- **Tested by Telcordia – meets NEBS Level 3**
- American Bureau of Shipping approved
- Available with NEMA hole sizes and spacing

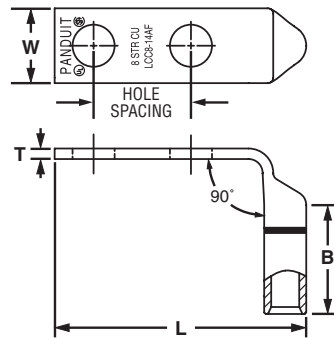

Part Number	Copper Conductor Size	Stud Hole Size (In.)	Stud Hole Spacing (In.)	Figure Dimensions (In.)				PANDUIT Color Code	PANDUIT Die Index No.‡	Burdny Die Index No.‡	T and B Die Index No.‡	Wire Strip Length (In.)	Std. Pkg. Qty.
				W	B	T	L						
LCC8-10AF-L	#8 AWG	#10	.63	.41	.70	.08	1.53	Red	P21	49	21	3/4	50
LCC8-14AF-L		1/4	.63	.48	.70	.07	1.62	Red	P21	49	21	3/4	50
LCC8-14BF-L		1/4	.75	.48	.70	.07	1.74	Red	P21	49	21	3/4	50
LCC8-14DF-L		1/4	1.00	.48	.70	.07	1.99	Red	P21	49	21	3/4	50
LCC8-38DF-L		3/8	1.00	.60	.70	.05	2.21	Red	P21	49	21	3/4	50
LCC6-10AF-L	#6 AWG	#10	.63	.46	1.07	.08	1.57	Blue	P24	7	24	1 1/8	50
LCC6-14AF-L		1/4	.63	.48	1.07	.08	1.66	Blue	P24	7	24	1 1/8	50
LCC6-14BF-L		1/4	.75	.48	1.07	.08	1.78	Blue	P24	7	24	1 1/8	50
LCC6-14DF-L		1/4	1.00	.48	1.07	.08	2.03	Blue	P24	7	24	1 1/8	50
LCC6-38DF-L		3/8	1.00	.62	1.07	.05	2.25	Blue	P24	7	24	1 1/8	50
LCC4-14AF-L	#4 – 3 AWG STR, #2 AWG SOL	1/4	.63	.55	1.05	.09	1.74	Gray	P29	8	29	1 1/8	50
LCC4-14BF-L		1/4	.75	.55	1.05	.09	1.87	Gray	P29	8	29	1 1/8	50
LCC4-38DF-L		3/8	1.00	.62	1.05	.08	2.34	Gray	P29	8	29	1 1/8	50
LCC2-14AF-Q	#2 AWG	1/4	.63	.60	1.16	.10	1.86	Brown	P33	10	33	1 1/4	25
LCC2-14BF-Q		1/4	.75	.60	1.16	.10	1.99	Brown	P33	10	33	1 1/4	25
LCC2-56BF-Q		5/16	.75	.66	1.16	.10	2.11	Brown	P33	10	33	1 1/4	25
LCC2-56CF-Q		5/16	.88	.66	1.16	.10	2.24	Brown	P33	10	33	1 1/4	25
LCC2-38DF-Q		3/8	1.00	.66	1.16	.10	2.44	Brown	P33	10	33	1 1/4	25
LCC2-38F-Q		3/8	1.75	.66	1.16	.10	3.19	Brown	P33	10	33	1 1/4	25
LCC2-12F-Q		1/2	1.75	.75	1.16	.08	3.61	Brown	P33	10	33	1 1/4	25

‡See pages D3.58 – D3.61 for tool and die information.

**Consult cable manufacturer for voltage stress relief instructions with applications greater than 2000 V.

Table continues on page D2.46

A. System Overview

B1. Cable Ties

B2. Cable Accessories

B3. Stainless Steel Ties

C1. Wiring Duct

C2. Surface Raceway

C3. Abrasion Protection

C4. Cable Management

D1. Terminals

D2. Power Connectors

D3. Grounding Connectors

E1. Labeling Systems

E2. Labels

E3. Pre-Printed & Write-On Markers

E4. Permanent Identification

E5. Lockout/Tagout & Safety Solutions

F. Index

A.
System
Overview



Code Conductor, Two-Hole, Long Barrel Lug, 90° Angle (continued)

B1.
Cable Ties

B2.
Cable
Accessories

B3.
Stainless
Steel Ties

C1.
Wiring
Duct

C2.
Surface
Raceway

C3.
Abrasion
Protection

C4.
Cable
Management

D1.
Terminals

D2.
Power
Connectors

D3.
Grounding
Connectors

E1.
Labeling
Systems

E2.
Labels

E3.
Pre-Printed
& Write-On
Markers

E4.
Permanent
Identification

E5.
Lockout/
Tagout
& Safety
Solutions

F.
Index

Part Number	Copper Conductor Size	Stud Hole Size (In.)	Stud Hole Spacing (In.)	Figure Dimensions (In.)				PANDUIT Color Code	PANDUIT Die Index No.‡	Burndy Die Index No.‡	T and B Die Index No.‡	Wire Strip Length (In.)	Std. Pkg. Qty.	
				W	B	T	L							
LCC1-14AF-E	#1 AWG	1/4	.63	.70	1.36	.11	1.94	Green	P37	11	37	1 7/16	20	
LCC1-14BF-E		1/4	.75	.70	1.36	.11	2.06	Green	P37	11	37	1 7/16	20	
LCC1-56BF-E		5/16	.75	.70	1.36	.11	2.19	Green	P37	11	37	1 7/16	20	
LCC1-56CF-E		5/16	.88	.70	1.36	.11	2.31	Green	P37	11	37	1 7/16	20	
LCC1-38DF-E		3/8	1.00	.70	1.36	.11	2.51	Green	P37	11	37	1 7/16	20	
LCC1-12F-E		1/2	1.75	.75	1.36	.09	3.68	Green	P37	11	37	1 7/16	20	
LCC1/0-14AF-X	1/0 AWG	1/4	.63	.76	1.44	.12	2.08	Pink	P42	12	42	1 1/2	10	
LCC1/0-14BF-X		1/4	.75	.76	1.44	.12	2.20	Pink	P42	12	42	1 1/2	10	
LCC1/0-56CF-X		5/16	.88	.76	1.44	.12	2.38	Pink	P42	12	42	1 1/2	10	
LCC1/0-56DF-X		5/16	1.00	.76	1.44	.12	2.51	Pink	P42	12	42	1 1/2	10	
LCC1/0-38DF-X		3/8	1.00	.76	1.44	.12	2.58	Pink	P42	12	42	1 1/2	10	
LCC1/0-12DF-X		1/2	1.00	.80	1.44	.12	2.85	Pink	P42	12	42	1 1/2	10	
LCC1/0-12F-X	1/2	1.75	.80	1.44	.12	3.75	Pink	P42	12	42	1 1/2	10		
LCC2/0-14AF-X	2/0 AWG	1/4	.63	.85	1.50	.13	2.22	Black	P45	13	45	1 9/16	10	
LCC2/0-14BF-X		1/4	.75	.85	1.50	.13	2.34	Black	P45	13	45	1 9/16	10	
LCC2/0-56DF-X		5/16	1.00	.85	1.50	.13	2.59	Black	P45	13	45	1 9/16	10	
LCC2/0-38DF-X		3/8	1.00	.85	1.50	.13	2.66	Black	P45	13	45	1 9/16	10	
LCC2/0-12DF-X		1/2	1.00	.85	1.50	.13	2.85	Black	P45	13	45	1 9/16	10	
LCC2/0-12F-X		1/2	1.75	.85	1.50	.13	3.82	Black	P45	13	45	1 9/16	10	
LCC3/0-14BF-X	3/0 AWG	1/4	.75	.96	1.50	.13	2.42	Orange	P50	14	50	1 9/16	10	
LCC3/0-38DF-X		3/8	1.00	.96	1.50	.13	2.73	Orange	P50	14	50	1 9/16	10	
LCC3/0-12DF-X		1/2	1.00	.96	1.50	.13	2.98	Orange	P50	14	50	1 9/16	10	
LCC3/0-12F-X		1/2	1.75	.96	1.50	.13	3.89	Orange	P50	14	50	1 9/16	10	
LCC4/0-14BF-X		4/0 AWG	1/4	.75	1.06	1.56	.14	2.50	Purple	P54	15	54	1 5/8	10
LCC4/0-56DF-X			5/16	1.00	1.06	1.56	.14	2.77	Purple	P54	15	54	1 5/8	10
LCC4/0-38DF-X	3/8		1.00	1.06	1.56	.14	2.84	Purple	P54	15	54	1 5/8	10	
LCC4/0-38F-X	3/8		1.75	1.06	1.56	.14	3.59	Purple	P54	15	54	1 5/8	10	
LCC4/0-12DF-X	1/2		1.00	1.06	1.56	.14	3.07	Purple	P54	15	54	1 5/8	10	
LCC4/0-12F-X	1/2		1.75	1.06	1.56	.14	3.98	Purple	P54	15	54	1 5/8	10	
LCC250-38DF-X	250 kcmil	3/8	1.00	1.17	1.61	.14	2.90	Yellow	P62	16	62	1 11/16	10	
LCC250-12DF-X		1/2	1.00	1.17	1.61	.14	3.13	Yellow	P62	16	62	1 11/16	10	
LCC250-12F-X		1/2	1.75	1.17	1.61	.14	4.04	Yellow	P62	16	62	1 11/16	10	
LCC300-38DF-X	300 kcmil	3/8	1.00	1.19	2.24	.16	2.88	White	P66	17	66	2 5/16	10	
LCC300-12F-X		1/2	1.75	1.19	2.24	.16	4.06	White	P66	17	66	2 5/16	10	
LCC350-14BF-X	350 kcmil	1/4	.75	1.28	2.24	.17	2.46	Red	P71	18	71	2 5/16	10	
LCC350-38DF-X		3/8	1.00	1.28	2.24	.17	2.94	Red	P71	18	71	2 5/16	10	
LCC350-12F-X		1/2	1.75	1.28	2.24	.17	4.12	Red	P71	18	71	2 5/16	10	
LCC400-14BF-6	400 kcmil	1/4	.75	1.39	2.30	.18	2.54	Blue	P76	19	76	2 3/8	6	
LCC400-38DF-6		3/8	1.00	1.39	2.30	.18	3.02	Blue	P76	19	76	2 3/8	6	
LCC400-12F-6		1/2	1.75	1.39	2.30	.18	4.20	Blue	P76	19	76	2 3/8	6	
LCC500-14BF-6	500 kcmil	1/4	.75	1.54	2.50	.22	2.65	Brown	P87	20	87	2 9/16	6	
LCC500-38DF-6		3/8	1.00	1.54	2.50	.22	3.13	Brown	P87	20	87	2 9/16	6	
LCC500-12F-6		1/2	1.75	1.54	2.50	.22	4.31	Brown	P87	20	87	2 9/16	6	
LCC600-38DF-6	600 kcmil	3/8	1.00	1.70	2.69	.26	3.26	Green	P94	22	94	2 3/4	6	
LCC600-12F-6		1/2	1.75	1.70	2.69	.26	4.44	Green	P94	22	94	2 3/4	6	

‡See pages D3.58 – D3.61 for tool and die information.

**Consult cable manufacturer for voltage stress relief instructions with applications greater than 2000 V.

◆NEMA hole sizes and spacing.



Code Conductor, Two-Hole, Long Barrel with Window Lug

For Use with Stranded Copper Conductors

Type LCC-W

- Long barrel maximizes number of crimps and provides premium wire pull-out strength and electrical performance
- Inspection window to visually assure full conductor insertion
- Color-coded barrels marked with *PANDUIT* and specified competitor die index numbers for proper crimp die selection
- Tin-plated to inhibit corrosion
- UL Listed and CSA Certified to 35 KV** and temperature rated to 90°C when crimped with *PANDUIT* and specified competitor crimping tools and dies
- UL Listed and CSA Certified for wide wire range-taking capability when crimped with *PANDUIT*® *UNI-DIE*™ Dieless Crimping Tools‡
- **Tested by Telcordia – meets NEBS Level 3**
- Meets J-STD-607-A and TIA-942 requirements for network systems grounding applications
- Available with NEMA hole sizes and spacing

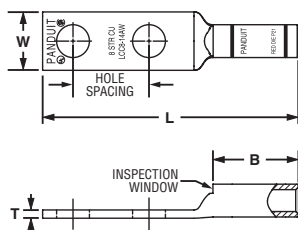

Figure 1

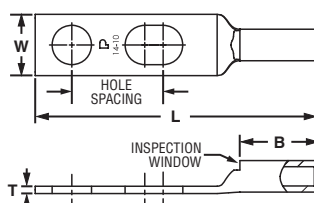

Figure 2: Slotted

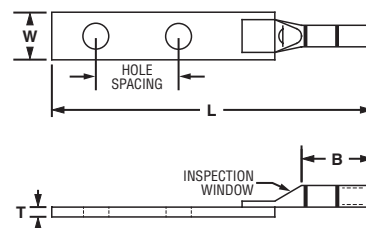

Figure 3: Two-Piece Brazed Tongue Construction

Part Number	Figure No.	Copper Conductor Size	Stud Hole Size (In.)	Stud Hole Spacing (In.)	Figure Dimensions (In.)				PANDUIT Color Code	PANDUIT Die Index No.‡	Burndy Die Index No.‡	T&B Die Index No.‡	Wire Strip Length (In.)	Std. Pkg. Qty.	
					W	B	T	L							
LCC10-14JAW-L*	2	#14 – 10 AWG STR.	1/4	.50 – .63	.42	.53	.05	1.93	—	—	—	—	9/16	50	
LCC10-14AW-L*	1	#12 – 10 AWG SOL	1/4	.63	.42	.53	.05	1.93	—	—	—	—	9/16	50	
LCC10-14BW-L*	1		1/4	.75	.42	.53	.05	2.06	—	—	—	—	9/16	50	
LCC8-10AW-L	1	#8 AWG	#10	.63	.41	.70	.08	2.01	Red	P21	49	21	3/4	50	
LCC8-10BW-L	1		#10	.75	.41	.70	.08	2.14	Red	P21	49	21	3/4	50	
LCC8-10ABW-L	2		#10	.63 – .75	.41	.70	.08	2.14	Red	P21	49	21	3/4	50	
LCC8-14AW-L	1		1/4	.63	.48	.70	.07	2.10	Red	P21	49	21	3/4	50	
LCC8-14BW-L	1		1/4	.75	.48	.70	.07	2.23	Red	P21	49	21	3/4	50	
LCC8-14ABW-L	2		1/4	.63 – .75	.48	.70	.07	2.23	Red	P21	49	21	3/4	50	
LCC8-14DW-L	1		1/4	1.00	.48	.70	.07	2.48	Red	P21	49	21	3/4	50	
LCC8-38DW-L	1		3/8	1.00	.60	.70	.05	2.70	Red	P21	49	21	3/4	50	
LCC6-10AW-L	1		#6 AWG	#10	.63	.46	1.07	.08	2.40	Blue	P24	7	24	1 1/8	50
LCC6-10BW-L	1			#10	.75	.46	1.07	.08	2.52	Blue	P24	7	24	1 1/8	50
LCC6-10ABW-L	2	#10		.63 – .75	.46	1.07	.08	2.52	Blue	P24	7	24	1 1/8	50	
LCC6-14JW-L	1	1/4		.50	.48	1.07	.08	2.36	Blue	P24	7	24	1 1/8	50	
LCC6-14AW-L	1	1/4		.63	.48	1.07	.08	2.49	Blue	P24	7	24	1 1/8	50	
LCC6-14JAW-L	2	1/4		.50 – .63	.48	1.07	.08	2.49	Blue	P24	7	24	1 1/8	50	
LCC6-14BW-L	1	1/4		.75	.48	1.07	.08	2.61	Blue	P24	7	24	1 1/8	50	
LCC6-14DW-L	1	1/4		1.00	.48	1.07	.08	2.86	Blue	P24	7	24	1 1/8	50	
LCC6-14BDW-L	2	1/4		.75 – 1.00	.48	1.07	.08	2.86	Blue	P24	7	24	1 1/8	50	
LCC6-14EW-L	1	1/4		1.25	.48	1.07	.08	3.11	Blue	P24	7	24	1 1/8	50	
LCC6-14W-L	1	1/4		1.75	.48	1.07	.08	3.61	Blue	P24	7	24	1 1/8	50	
LCC6-56BW-L	1	5/16		.75	.56	1.07	.07	2.73	Blue	P24	7	24	1 1/8	50	
LCC6-38BW-L	1	3/8		.75	.62	1.07	.06	2.83	Blue	P24	7	24	1 1/8	50	
LCC6-38CW-L	1	3/8		.88	.62	1.07	.06	2.96	Blue	P24	7	24	1 1/8	50	
LCC6-38DW-L	1	3/8		1.00	.62	1.07	.06	3.08	Blue	P24	7	24	1 1/8	50	
LCC6-38BDW-L	2	3/8		.75 – 1.00	.62	1.07	.06	3.08	Blue	P24	7	24	1 1/8	50	
LCC6-12W-L	3	1/2		1.75	.75	1.13	.16	5.00	Blue	P24	7	24	1 3/16	50	

‡See pages D3.58 – D3.61 for tool and die information.

*Not tested to NEBS Level 3 requirements.

**Consult cable manufacturer for voltage stress relief instructions with applications greater than 2000 V.

Table continues on page D2.48

A. System Overview

B1. Cable Ties

B2. Cable Accessories

B3. Stainless Steel Ties

C1. Wiring Duct

C2. Surface Raceway

C3. Abrasion Protection

C4. Cable Management

D1. Terminals

D2. Power Connectors

D3. Grounding Connectors

E1. Labeling Systems

E2. Labels

E3. Pre-Printed & Write-On Markers

E4. Permanent Identification

E5. Lockout/Tagout & Safety Solutions

F. Index

A.
System
Overview



Code Conductor, Two-Hole, Long Barrel with Window Lug (continued)

B1.
Cable Ties

B2.
Cable
Accessories

B3.
Stainless
Steel Ties

C1.
Wiring
Duct

C2.
Surface
Raceway

C3.
Abrasion
Protection

C4.
Cable
Management

D1.
Terminals

D2.
Power
Connectors

D3.
Grounding
Connectors

E1.
Labeling
Systems

E2.
Labels

E3.
Pre-Printed
& Write-On
Markers

E4.
Permanent
Identification

E5.
Lockout/
Tagout
& Safety
Solutions

F.
Index

Part Number	Figure No.	Copper Conductor Size	Stud Hole Size (In.)	Stud Hole Spacing (In.)	Figure Dimensions (In.)				PANDUIT Color Code	PANDUIT Die Index No.‡	Burndy Die Index No.‡	T&B Die Index No.‡	Wire Strip Length (In.)	Std. Pkg. Qty.	
					W	B	T	L							
LCC4-10AW-L	1	#4 – 3 AWG STR, #2 AWG SOL	#10	.63	.55	1.05	.09	2.40	Gray	P29	8	29	1 1/8	50	
LCC4-10BW-L	1		#10	.75	.55	1.05	.09	2.53	Gray	P29	8	29	1 1/8	50	
LCC4-14AW-L	1		1/4	.63	.55	1.05	.09	2.50	Gray	P29	8	29	1 1/8	50	
LCC4-14BW-L	1		1/4	.75	.55	1.05	.09	2.63	Gray	P29	8	29	1 1/8	50	
LCC4-14DW-L	1		1/4	1.00	.55	1.05	.09	2.63	Gray	P29	8	29	1 1/8	50	
LCC4-14ADW-L	2		1/4	.63 – 1.00	.55	1.05	.09	2.87	Gray	P29	8	29	1 1/8	50	
LCC4-38DW-L	1		3/8	1.00	.62	1.05	.08	3.09	Gray	P29	8	29	1 1/8	50	
LCC4-12W-L	3		1/2	1.75	.75	1.13	.16	5.06	Gray	P29	8	29	1 3/16	50	
LCC2-10AW-Q	1		#2 AWG	#10	.63	.60	1.16	.10	2.57	Brown	P33	10	33	1 1/4	25
LCC2-10BW-Q	1			#10	.75	.60	1.16	.10	2.69	Brown	P33	10	33	1 1/4	25
LCC2-14AW-Q	1	1/4		.63	.60	1.16	.10	2.67	Brown	P33	10	33	1 1/4	25	
LCC2-14BW-Q	1	1/4		.75	.60	1.16	.10	2.79	Brown	P33	10	33	1 1/4	25	
LCC2-14DW-Q	1	1/4		1.00	.60	1.16	.10	3.04	Brown	P33	10	33	1 1/4	25	
LCC2-56BW-Q	1	5/16		.75	.66	1.16	.10	2.92	Brown	P33	10	33	1 1/4	25	
LCC2-56CW-Q	1	5/16		.88	.66	1.16	.10	3.04	Brown	P33	10	33	1 1/4	25	
LCC2-38BW-Q	1	3/8		.75	.66	1.16	.10	2.99	Brown	P33	10	33	1 1/4	25	
LCC2-38CW-Q	1	3/8		.88	.66	1.16	.10	3.12	Brown	P33	10	33	1 1/4	25	
LCC2-38DW-Q	1	3/8		1.00	.66	1.16	.10	3.24	Brown	P33	10	33	1 1/4	25	
LCC2-38W-Q	1	3/8	1.75	.66	1.16	.10	3.99	Brown	P33	10	33	1 1/4	25		
LCC2-12W-Q	1	1/2	1.75	.75	1.16	.08	4.41	Brown	P33	10	33	1 1/4	25		
LCC1-14AW-E	1	#1 AWG	1/4	.63	.70	1.36	.11	2.89	Green	P37	11	37	1 7/16	20	
LCC1-14BW-E	1		1/4	.75	.70	1.36	.11	3.01	Green	P37	11	37	1 7/16	20	
LCC1-56BW-E	1		5/16	.75	.70	1.36	.11	3.14	Green	P37	11	37	1 7/16	20	
LCC1-56CW-E	1		5/16	.88	.70	1.36	.11	3.26	Green	P37	11	37	1 7/16	20	
LCC1-38DW-E	1		3/8	1.00	.70	1.36	.11	3.46	Green	P37	11	37	1 7/16	20	
LCC1-12W-E	1		1/2	1.75	.75	1.36	.09	4.63	Green	P37	11	37	1 7/16	20	
LCC1/0-14AW-X	1	1/0 AWG	1/4	.63	.76	1.44	.12	3.07	Pink	P42	12	42	1 1/2	10	
LCC1/0-14BW-X	1		1/4	.75	.76	1.44	.12	3.19	Pink	P42	12	42	1 1/2	10	
LCC1/0-14DW-X	1		1/4	1.00	.76	1.44	.12	3.44	Pink	P42	12	42	1 1/2	10	
LCC1/0-38DW-X	1		3/8	1.00	.76	1.44	.12	3.57	Pink	P42	12	42	1 1/2	10	
LCC1/0-38W-X	1		3/8	1.75	.76	1.44	.12	4.32	Pink	P42	12	42	1 1/2	10	
LCC1/0-12DW-X	1		1/2	1.00	.80	1.44	.12	3.84	Pink	P42	12	42	1 1/2	10	
LCC1/0-12W-X	1		1/2	1.75	.80	1.44	.12	4.74	Pink	P42	12	42	1 1/2	10	
LCC2/0-14AW-X	1		1/4	.63	.85	1.50	.13	3.23	Black	P45	13	45	1 9/16	10	
LCC2/0-14BW-X	1	1/4	.75	.85	1.50	.13	3.36	Black	P45	13	45	1 9/16	10		
LCC2/0-56DW-X	1	5/16	1.00	.85	1.50	.13	3.61	Black	P45	13	45	1 9/16	10		
LCC2/0-38DW-X	1	3/8	1.00	.85	1.50	.13	3.67	Black	P45	13	45	1 9/16	10		
LCC2/0-12DW-X	1	1/2	1.00	.85	1.50	.13	3.92	Black	P45	13	45	1 9/16	10		
LCC2/0-12W-X	1	1/2	1.75	.85	1.50	.13	4.83	Black	P45	13	45	1 9/16	10		

‡See pages D3.58 – D3.61 for tool and die information.

**Consult cable manufacturer for voltage stress relief instructions with applications greater than 2000 V.



Code Conductor, Two-Hole, Long Barrel with Window Lug (continued)

Part Number	Figure No.	Copper Conductor Size	Stud Hole Size (In.)	Stud Hole Spacing (In.)	Figure Dimensions (In.)				PANDUIT Color Code	PANDUIT Die Index No.†	Burndy Die Index No.‡	T&B Die Index No.‡	Wire Strip Length (In.)	Std. Pkg. Qty.
					W	B	T	L						
LCC3/0-14BW-X	1	3/0 AWG	1/4	.75	.96	1.50	.13	3.39	Orange	P50	14	50	1 9/16	10
LCC3/0-56DW-X	1		5/16	1.00	.96	1.50	.13	3.64	Orange	P50	14	50	1 9/16	10
LCC3/0-38DW-X	1		3/8	1.00	.96	1.50	.13	3.70	Orange	P50	14	50	1 9/16	10
LCC3/0-12DW-X	1		1/2	1.00	.96	1.50	.13	3.95	Orange	P50	14	50	1 9/16	10
LCC3/0-12W-X	1		1/2	1.75	.96	1.50	.13	4.87	Orange	P50	14	50	1 9/16	10
LCC4/0-14AW-X	1	4/0 AWG	1/4	.63	1.06	1.56	.14	3.35	Purple	P54	15	54	1 5/8	10
LCC4/0-14BW-X	1		1/4	.75	1.06	1.56	.14	3.48	Purple	P54	15	54	1 5/8	10
LCC4/0-56DW-X	1		5/16	1.00	1.06	1.56	.14	3.74	Purple	P54	15	54	1 5/8	10
LCC4/0-38DW-X	1		3/8	1.00	1.06	1.56	.14	3.81	Purple	P54	15	54	1 5/8	10
LCC4/0-38W-X	1		3/8	1.75	1.06	1.56	.14	4.56	Purple	P54	15	54	1 5/8	10
LCC4/0-12DW-X	1		1/2	1.00	1.06	1.56	.14	4.04	Purple	P54	15	54	1 5/8	10
◆ LCC4/0-12W-X	1	1/2	1.75	1.06	1.56	.14	4.95	Purple	P54	15	54	1 5/8	10	
LCC250-56DW-X	1	250 kcmil	5/16	1.00	1.17	1.61	.14	3.82	Yellow	P62	16	62	1 11/16	10
LCC250-38DW-X	1		3/8	1.00	1.17	1.61	.14	3.89	Yellow	P62	16	62	1 11/16	10
LCC250-12DW-X	1		1/2	1.00	1.17	1.61	.14	4.12	Yellow	P62	16	62	1 11/16	10
◆ LCC250-12W-X	1	1/2	1.75	1.17	1.61	.14	5.03	Yellow	P62	16	62	1 11/16	10	
LCC300-38DW-X	1	300 kcmil	3/8	1.00	1.19	2.24	.16	4.54	White	P66	17	66	2 5/16	10
◆ LCC300-12W-X	1		1/2	1.75	1.19	2.24	.16	5.72	White	P66	17	66	2 5/16	10
LCC350-14BW-X	1	350 kcmil	1/4	.75	1.28	2.24	.17	4.10	Red	P71	18	71	2 5/16	10
LCC350-38DW-X	1		3/8	1.00	1.28	2.24	.17	4.58	Red	P71	18	71	2 5/16	10
◆ LCC350-12W-X	1		1/2	1.75	1.28	2.24	.17	5.76	Red	P71	18	71	2 5/16	10
LCC400-14BW-6	1	400 kcmil	1/4	.75	1.39	2.30	.18	4.18	Blue	P76	19	76	2 3/8	6
LCC400-38DW-6	1		3/8	1.00	1.39	2.30	.18	4.66	Blue	P76	19	76	2 3/8	6
◆ LCC400-12W-6	1		1/2	1.75	1.28	2.30	.17	5.84	Blue	P76	19	76	2 3/8	6
LCC500-14BW-6	1	500 kcmil	1/4	.75	1.54	2.50	.22	4.46	Brown	P87	20	87	2 9/16	6
LCC500-38DW-6	1		3/8	1.00	1.54	2.50	.22	4.94	Brown	P87	20	87	2 9/16	6
◆ LCC500-12W-6	1		1/2	1.75	1.54	2.50	.22	6.12	Brown	P87	20	87	2 9/16	6
LCC600-38DW-6	1	600 kcmil	3/8	1.00	1.70	2.69	.26	5.18	Green	P94	22	94	2 3/4	6
◆ LCC600-12W-6	1		1/2	1.75	1.70	2.69	.26	6.36	Green	P94	22	94	2 3/4	6
LCC750-38DW-6	1	750 kcmil	3/8	1.00	1.89	2.88	.26	5.71	Black	P106	24	106	2 15/16	6
◆ LCC750-12W-6	1		1/2	1.75	1.89	2.88	.26	6.65	Black	P106	24	106	2 15/16	6
◆ LCC800-12W-6	1	800 kcmil	1/2	1.75	1.95	2.94	.30	6.74	Orange	P107	25	107	3	6
LCC1000-38DW-3	1	1000 kcmil	3/8	1.00	2.17	3.00	.32	5.95	White	P125	27	125	3 1/16	3
◆ LCC1000-12W-3	1		1/2	1.75	2.17	3.00	.32	6.89	White	P125	27	125	3 1/16	3

†See pages D3.58 – D3.61 for tool and die information.

**Consult cable manufacturer for voltage stress relief instructions with applications greater than 2000 V.

◆NEMA hole sizes and spacing.

A.
System
Overview

B1.
Cable
Ties

B2.
Cable
Accessories

B3.
Stainless
Steel
Ties

C1.
Wiring
Duct

C2.
Surface
Raceway

C3.
Abrasion
Protection

C4.
Cable
Management

D1.
Terminals

D2.
Power
Connectors

D3.
Grounding
Connectors

E1.
Labeling
Systems

E2.
Labels

E3.
Pre-Printed
& Write-On
Markers

E4.
Permanent
Identification

E5.
Lockout/
Tagout
& Safety
Solutions

F.
Index

A. System Overview



Code Conductor, Two-Hole, Long Barrel with Window Lug, 45° Angle

B1. Cable Ties

For Use with Stranded Copper Conductors

Type LCC-WH

- Long barrel maximizes number of crimps and provides premium wire pull-out strength and electrical performance
- Inspection window to visually assure full conductor insertion
- Color-coded barrels marked with **PANDUIT** and specified competitor die index numbers for proper crimp die selection
- Tin-plated to inhibit corrosion
- UL Listed and CSA Certified to 35 KV** and temperature rated to 90°C when crimped with **PANDUIT** and specified competitor crimping tools and dies

- UL Listed and CSA Certified for wide wire range-taking capability when crimped with **PANDUIT® UNI-DIE™** Dieless Crimping Tools‡
- **Tested by Telcordia – meets NEBS Level 3**
- Meets J-STD-607-A and TIA-942 requirements for network systems grounding applications
- Available with NEMA hole sizes and spacing

B3. Stainless Steel Ties

C1. Wiring Duct

C2. Surface Raceway

C3. Abrasion Protection

C4. Cable Management

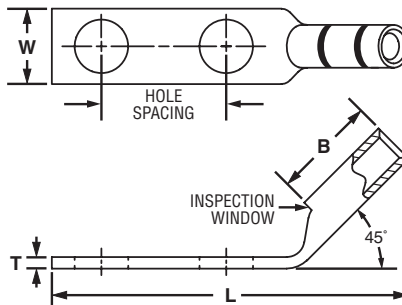

Figure 1

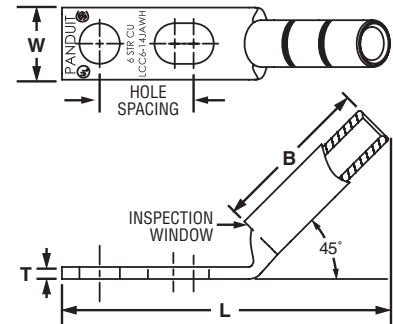

Figure 2: Slotted

D1. Terminals

D2. Power Connectors

D3. Grounding Connectors

E1. Labeling Systems

E2. Labels

E3. Pre-Printed & Write-On Markers

E4. Permanent Identification

E5. Lockout/Tagout & Safety Solutions

F. Index

Part Number	Figure No.	Copper Conductor Size	Stud Hole Size (In.)	Stud Hole Spacing (In.)	Figure Dimensions (In.)				PANDUIT Color Code	PANDUIT Die Index No.‡	Burdny Die Index No.‡	T&B Die Index No.‡	Wire Strip Length (In.)	Std. Pkg. Qty.
					W	B	T	L						
LCC10-14JAWH-L*	2	#14 – 10	1/4	.50 – .63	.42	.53	.05	1.78	—	—	—	—	9/16	50
LCC10-14AWH-L*	1	AWG STR	1/4	.63	.42	.53	.05	1.78	—	—	—	—	9/16	50
LCC10-14BWH-L*	1	#12 – 10 AWG SOL	1/4	.75	.42	.53	.05	1.90	—	—	—	—	9/16	50
LCC8-10AWH-L	1	#8 AWG	#10	.63	.41	.70	.08	1.82	Red	P21	49	21	3/4	50
LCC8-10BWH-L	1		#10	.75	.41	.70	.08	1.95	Red	P21	49	21	3/4	50
LCC8-14AWH-L	1		1/4	.63	.48	.70	.07	1.91	Red	P21	49	21	3/4	50
LCC8-14BWH-L	1		1/4	.75	.48	.70	.07	2.03	Red	P21	49	21	3/4	50
LCC8-14DWH-L	1		1/4	1.00	.48	.70	.07	2.28	Red	P21	49	21	3/4	50
LCC8-38DWH-L	1		3/8	1.00	.60	.70	.05	2.49	Red	P21	49	21	3/4	50
LCC6-10AWH-L	1		#10	.63	.46	1.07	.08	2.09	Blue	P24	7	24	1 1/8	50
LCC6-10BWH-L	1	#10	.75	.46	1.07	.08	2.22	Blue	P24	7	24	1 1/8	50	
LCC6-14JWH-L	1	1/4	.50	.48	1.07	.08	2.06	Blue	P24	7	24	1 1/8	50	
LCC6-14AWH-L	1	1/4	.63	.48	1.07	.08	2.18	Blue	P24	7	24	1 1/8	50	
LCC6-14JAWH-L	2	1/4	.50 – .63	.48	1.07	.08	2.08	Blue	P24	7	24	1 1/8	50	
LCC6-14BWH-L	1	1/4	.75	.48	1.07	.08	2.31	Blue	P24	7	24	1 1/8	50	
LCC6-14DWH-L	1	1/4	1.00	.48	1.07	.08	2.56	Blue	P24	7	24	1 1/8	50	
LCC6-14EWH-L	1	1/4	1.25	.48	1.07	.08	2.81	Blue	P24	7	24	1 1/8	50	
LCC6-56BWH-L	1	5/16	.75	.56	1.07	.07	2.42	Blue	P24	7	24	1 1/8	50	
LCC6-38BWH-L	1	3/8	.75	.62	1.07	.06	2.52	Blue	P24	7	24	1 1/8	50	
LCC6-38CWH-L	1	3/8	.88	.62	1.07	.06	2.64	Blue	P24	7	24	1 1/8	50	
LCC6-38DWH-L	1	3/8	1.00	.62	1.07	.06	2.77	Blue	P24	7	24	1 1/8	50	

‡See pages D3.58 – D3.61 for tool and die information.

*Not tested to NEBS Level 3 requirements.

**Consult cable manufacturer for voltage stress relief instructions with applications greater than 2000 V.



Code Conductor, Two-Hole, Long Barrel with Window Lug, 45° Angle (continued)

A.
System
Overview

B1.
Cable Ties

B2.
Cable
Accessories

B3.
Stainless
Steel Ties

C1.
Wiring
Duct

C2.
Surface
Raceway

C3.
Abrasion
Protection

C4.
Cable
Management

D1.
Terminals

D2.
Power
Connectors

D3.
Grounding
Connectors

E1.
Labeling
Systems

E2.
Labels

E3.
Pre-Printed
& Write-On
Markers

E4.
Permanent
Identification

E5.
Lockout/
Tagout
& Safety
Solutions

F.
Index

Part Number	Figure No.	Copper Conductor Size	Stud Hole Size (In.)	Stud Hole Spacing (In.)	Figure Dimensions (In.)				PANDUIT Color Code	PANDUIT Die Index No.‡	Burdny Die Index No.‡	T&B Die Index No.‡	Wire Strip Length (In.)	Std. Pkg. Qty.	
					W	B	T	L							
LCC4-10AWH-L	1	#4 – 3 AWG STR, #2 AWG SOL	#10	.63	.55	1.05	.09	2.11	Gray	P29	8	29	1 1/8	50	
LCC4-10BWH-L	1		#10	.75	.55	1.05	.09	2.23	Gray	P29	8	29	1 1/8	50	
LCC4-14AWH-L	1		1/4	.63	.55	1.05	.09	2.20	Gray	P29	8	29	1 1/8	50	
LCC4-14BWH-L	1		1/4	.75	.55	1.05	.09	2.32	Gray	P29	8	29	1 1/8	50	
LCC4-38DWH-L	1	#2 AWG	3/8	1.00	.62	1.05	.08	2.79	Gray	P29	8	29	1 1/8	50	
LCC2-10AWH-Q	1		#10	.63	.60	1.16	.10	2.21	Brown	P33	10	33	1 1/4	25	
LCC2-10BWH-Q	1		#10	.75	.60	1.16	.10	2.33	Brown	P33	10	33	1 1/4	25	
LCC2-14AWH-Q	1		1/4	.63	.60	1.16	.10	2.31	Brown	P33	10	33	1 1/4	25	
LCC2-14BWH-Q	1		1/4	.75	.60	1.16	.10	2.43	Brown	P33	10	33	1 1/4	25	
LCC2-14DWH-Q	1		1/4	1.00	.60	1.16	.10	2.68	Brown	P33	10	33	1 1/4	25	
LCC2-56BWH-Q	1		5/16	.75	.66	1.16	.10	2.55	Brown	P33	10	33	1 1/4	25	
LCC2-56CWH-Q	1		5/16	.88	.66	1.16	.10	2.68	Brown	P33	10	33	1 1/4	25	
LCC2-38BWH-Q	1		3/8	.75	.66	1.16	.10	2.63	Brown	P33	10	33	1 1/4	25	
LCC2-38CWH-Q	1		3/8	.88	.66	1.16	.10	2.75	Brown	P33	10	33	1 1/4	25	
LCC2-38DWH-Q	1		3/8	1.00	.66	1.16	.10	2.88	Brown	P33	10	33	1 1/4	25	
LCC2-38WH-Q	1		3/8	1.75	.66	1.16	.10	3.63	Brown	P33	10	33	1 1/4	25	
LCC2-12WH-Q	1		1/2	1.75	.75	1.16	.08	4.03	Brown	P33	10	33	1 1/4	25	
LCC1-14AWH-E	1		#1 AWG	1/4	.63	.70	1.36	.11	2.46	Green	P37	11	37	1 7/16	20
LCC1-14BWH-E	1			1/4	.75	.70	1.36	.11	2.58	Green	P37	11	37	1 7/16	20
LCC1-56BWH-E	1			5/16	.75	.70	1.36	.11	2.71	Green	P37	11	37	1 7/16	20
LCC1-56CWH-E	1	5/16		.88	.70	1.36	.11	2.83	Green	P37	11	37	1 7/16	20	
LCC1-38DWH-E	1	3/8		1.00	.70	1.36	.11	3.04	Green	P37	11	37	1 7/16	20	
LCC1-12WH-E	1	1/2		1.75	.75	1.36	.09	4.20	Green	P37	11	37	1 7/16	20	
LCC1-0-14AWH-X	1	1/0 AWG		1/4	.63	.76	1.44	.12	2.61	Pink	P42	12	42	1 1/2	10
LCC1-0-14BWH-X	1			1/4	.75	.76	1.44	.12	2.73	Pink	P42	12	42	1 1/2	10
LCC1-0-14DWH-X	1		1/4	1.00	.76	1.44	.12	2.98	Pink	P42	12	42	1 1/2	10	
LCC1-0-38DWH-X	1		3/8	1.00	.76	1.44	.12	3.11	Pink	P42	12	42	1 1/2	10	
LCC1-0-38WH-X	1		3/8	1.75	.76	1.44	.12	3.86	Pink	P42	12	42	1 1/2	10	
LCC1-0-12DWH-X	1		1/2	1.00	.80	1.44	.12	3.37	Pink	P42	12	42	1 1/2	10	
LCC1-0-12WH-X	1		1/2	1.75	.80	1.44	.12	4.28	Pink	P42	12	42	1 1/2	10	
LCC2-0-14AWH-X	1		2/0 AWG	1/4	.63	.85	1.50	.13	2.76	Black	P45	13	45	1 9/16	10
LCC2-0-14BWH-X	1	1/4		.75	.85	1.50	.13	2.88	Black	P45	13	45	1 9/16	10	
LCC2-0-56DWH-X	1	5/16		1.00	.85	1.50	.13	3.13	Black	P45	13	45	1 9/16	10	
LCC2-0-38DWH-X	1	3/8		1.00	.85	1.50	.13	3.20	Black	P45	13	45	1 9/16	10	
LCC2-0-12DWH-X	1	1/2		1.00	.85	1.50	.13	3.45	Black	P45	13	45	1 9/16	10	
LCC2-0-12WH-X	1	1/2		1.75	.85	1.50	.13	4.36	Black	P45	13	45	1 9/16	10	
LCC3-0-14BWH-X	1	3/0 AWG		1/4	.75	.96	1.50	.13	2.91	Orange	P50	14	50	1 9/16	10
LCC3-0-56DWH-X	1			5/16	1.00	.96	1.50	.13	3.16	Orange	P50	14	50	1 9/16	10
LCC3-0-38DWH-X	1		3/8	1.00	.96	1.50	.13	3.22	Orange	P50	14	50	1 9/16	10	
LCC3-0-12DWH-X	1		1/2	1.00	.96	1.50	.13	3.47	Orange	P50	14	50	1 9/16	10	
LCC3-0-12WH-X	1		1/2	1.75	.96	1.50	.13	4.38	Orange	P50	14	50	1 9/16	10	
LCC4-0-14AWH-X	1		4/0 AWG	1/4	.63	1.06	1.56	.14	2.85	Purple	P54	15	54	1 5/8	10
LCC4-0-14BWH-X	1			1/4	.75	1.06	1.56	.14	2.98	Purple	P54	15	54	1 5/8	10
LCC4-0-56DWH-X	1			5/16	1.00	1.06	1.56	.14	3.24	Purple	P54	15	54	1 5/8	10
LCC4-0-38DWH-X	1	3/8		1.00	1.06	1.56	.14	3.31	Purple	P54	15	54	1 5/8	10	
LCC4-0-38WH-X	1	3/8		1.75	1.06	1.56	.14	4.06	Purple	P54	15	54	1 5/8	10	
LCC4-0-12DWH-X	1	1/2		1.00	1.06	1.56	.14	3.54	Purple	P54	15	54	1 5/8	10	
LCC4-0-12WH-X	1	1/2		1.75	1.06	1.56	.14	4.45	Purple	P54	15	54	1 5/8	10	

‡See pages D3.58 – D3.61 for tool and die information.

**Consult cable manufacturer for voltage stress relief instructions with applications greater than 2000 V.

◆NEMA hole sizes and spacing.

Table continues on page D2.52

A.
System
Overview



Code Conductor, Two-Hole, Long Barrel with Window Lug, 45° Angle (continued)

B1.
Cable Ties

B2.
Cable
Accessories

B3.
Stainless
Steel Ties

C1.
Wiring
Duct

C2.
Surface
Raceway

C3.
Abrasion
Protection

C4.
Cable
Management

D1.
Terminals

D2.
Power
Connectors

D3.
Grounding
Connectors

E1.
Labeling
Systems

E2.
Labels

E3.
Pre-Printed
& Write-On
Markers

E4.
Permanent
Identification

E5.
Lockout/
Tagout
& Safety
Solutions

F.
Index

Part Number	Figure No.	Copper Conductor Size	Stud Hole Size (In.)	Stud Hole Spacing (In.)	Figure Dimensions (In.)				PANDUIT Color Code	PANDUIT Die Index No.‡	Burndy Die Index No.‡	T&B Die Index No.‡	Wire Strip Length (In.)	Std. Pkg. Qty.
					W	B	T	L						
LCC250-56DWH-X	1	250 kcmil	5/16	1.00	1.17	1.61	.14	3.31	Yellow	P62	16	62	1 11/16	10
LCC250-38DWH-X	1		3/8	1.00	1.17	1.61	.14	3.38	Yellow	P62	16	62	1 11/16	10
LCC250-12DWH-X	1		1/2	1.00	1.17	1.61	.14	3.61	Yellow	P62	16	62	1 11/16	10
◆ LCC250-12WH-X	1	300 kcmil	1/2	1.75	1.17	1.61	.14	4.52	Yellow	P62	16	62	1 11/16	10
LCC300-38DWH-X	1		3/8	1.00	1.19	2.24	.16	3.93	White	P66	17	66	2 5/16	10
◆ LCC300-12WH-X	1		1/2	1.75	1.19	2.24	.16	5.11	White	P66	17	66	2 5/16	10
LCC350-14BWH-X	1	350 kcmil	1/4	.75	1.28	2.24	.17	3.48	Red	P71	18	71	2 5/16	10
LCC350-38DWH-X	1		3/8	1.00	1.28	2.24	.17	3.96	Red	P71	18	71	2 5/16	10
◆ LCC350-12WH-X	1		1/2	1.75	1.28	2.24	.17	5.14	Red	P71	18	71	2 5/16	10
LCC400-14BWH-6	1	400 kcmil	1/4	.75	1.39	2.30	.18	3.59	Blue	P76	19	76	2 3/8	6
LCC400-38DWH-6	1		3/8	1.00	1.39	2.30	.18	4.07	Blue	P76	19	76	2 3/8	6
◆ LCC400-12WH-6	1		1/2	1.75	1.28	2.30	.17	5.24	Blue	P76	19	76	2 3/8	6
LCC500-14BWH-6	1	500 kcmil	1/4	.75	1.54	2.50	.22	3.80	Brown	P87	20	87	2 9/16	6
LCC500-38DWH-6	1		3/8	1.00	1.54	2.50	.22	4.29	Brown	P87	20	87	2 9/16	6
◆ LCC500-12WH-6	1		1/2	1.75	1.54	2.50	.22	5.46	Brown	P87	20	87	2 9/16	6
LCC600-38DWH-6	1	600 kcmil	3/8	1.00	1.70	2.69	.26	4.47	Green	P94	22	94	2 3/4	6
◆ LCC600-12WH-6	1		1/2	1.75	1.70	2.69	.26	5.65	Green	P94	22	94	2 3/4	6

‡See pages D3.58 – D3.61 for tool and die information.

**Consult cable manufacturer for voltage stress relief instructions with applications greater than 2000 V.

◆NEMA hole sizes and spacing.



Code Conductor, Two-Hole, Long Barrel with Window Lug, 90° Angle

For Use with Stranded Copper Conductors

Type LCC-WF

- Long barrel maximizes number of crimps and provides premium wire pull-out strength and electrical performance
- Inspection window to visually assure full conductor insertion
- Color-coded barrels marked with *PANDUIT* and specified competitor die index numbers for proper crimp die selection
- Tin-plated to inhibit corrosion
- UL Listed and CSA Certified to 35 KV** and temperature rated to 90°C when crimped with *PANDUIT* and specified competitor crimping tools and dies
- UL Listed and CSA Certified for wide wire range-taking capability when crimped with *PANDUIT*® *UNI-DIE*™ Dieless Crimping Tools‡
- **Tested by Telcordia – meets NEBS Level 3**
- Meets J-STD-607-A and TIA-942 requirements for network systems grounding applications
- Available with NEMA hole sizes and spacing

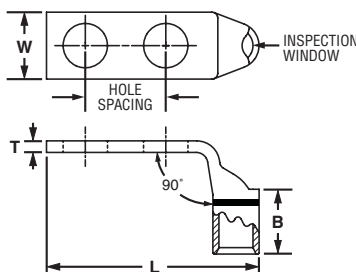

Figure 1

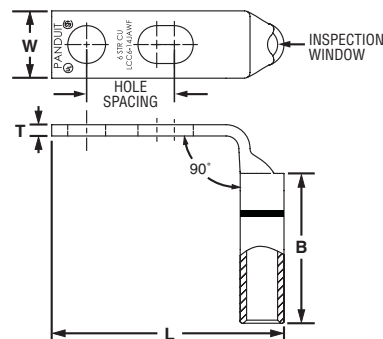

Figure 2: Slotted

Part Number	Figure No.	Copper Conductor Size	Stud Hole Size (In.)	Stud Hole Spacing (In.)	Figure Dimensions (In.)				PANDUIT Color Code	PANDUIT Die Index No.‡	Burdy Die Index No.‡	T&B Die Index No.‡	Wire Strip Length (In.)	Std. Pkg. Qty.
					W	B	T	L						
LCC10-14JAWF-L*	2	#14 – 10	1/4	.50 – .63	.42	.53	.05	1.56	—	—	—	—	9/16	50
LCC10-14AWF-L*	1	AWG STR,	1/4	.63	.42	.53	.05	1.56	—	—	—	—	9/16	50
LCC10-14BWF-L*	1	#12 – 10 AWG SOL	1/4	.75	.42	.53	.05	1.69	—	—	—	—	9/16	50
LCC8-10AWF-L	1	#8 AWG	#10	.63	.41	.70	.08	1.53	Red	P21	49	21	3/4	50
LCC8-10BWF-L	1		#10	.75	.41	.70	.08	1.65	Red	P21	49	21	3/4	50
LCC8-14AWF-L	1		1/4	.63	.48	.70	.07	1.61	Red	P21	49	21	3/4	50
LCC8-14BWF-L	1		1/4	.75	.48	.70	.07	1.74	Red	P21	49	21	3/4	50
LCC8-14DWF-L	1		1/4	1.00	.48	.70	.07	1.99	Red	P21	49	21	3/4	50
LCC8-38DWF-L	1		3/8	1.00	.60	.70	.05	2.21	Red	P21	49	21	3/4	50
LCC6-10AWF-L	1	#6 AWG	#10	.63	.46	1.07	.08	1.57	Blue	P24	7	24	1 1/8	50
LCC6-10BWF-L	1		#10	.75	.46	1.07	.08	1.69	Blue	P24	7	24	1 1/8	50
LCC6-14JWF-L	1		1/4	.50	.48	1.07	.08	1.53	Blue	P24	7	24	1 1/8	50
LCC6-14AWF-L	1		1/4	.63	.48	1.07	.08	1.66	Blue	P24	7	24	1 1/8	50
LCC6-14JAWF-L	2		1/4	.50 – .63	.48	1.07	.08	1.66	Blue	P24	7	24	1 1/8	50
LCC6-14BWF-L	1		1/4	.75	.48	1.07	.08	1.78	Blue	P24	7	24	1 1/8	50
LCC6-14DWF-L	1		1/4	1.00	.48	1.07	.08	2.03	Blue	P24	7	24	1 1/8	50
LCC6-14EWF-L	1		1/4	1.25	.48	1.07	.08	2.28	Blue	P24	7	24	1 1/8	50
LCC6-56BWF-L	1		5/16	.75	.56	1.07	.07	1.90	Blue	P24	7	24	1 1/8	50
LCC6-38BWF-L	1		3/8	.75	.62	1.07	.06	2.00	Blue	P24	7	24	1 1/8	50
LCC6-38CWF-L	1	3/8	.88	.62	1.07	.06	2.13	Blue	P24	7	24	1 1/8	50	
LCC6-38DWF-L	1	3/8	1.00	.62	1.07	.06	2.25	Blue	P24	7	24	1 1/8	50	

‡See pages D3.58 – D3.61 for tool and die information.

*Not tested to NEBS Level 3 requirements.

**Consult cable manufacturer for voltage stress relief instructions with applications greater than 2000 V.

Table continues on pages D2.54 — D2.55

- A. System Overview
- B1. Cable Ties
- B2. Cable Accessories
- B3. Stainless Steel Ties
- C1. Wiring Duct
- C2. Surface Raceway
- C3. Abrasion Protection
- C4. Cable Management
- D1. Terminals
- D2. Power Connectors
- D3. Grounding Connectors
- E1. Labeling Systems
- E2. Labels
- E3. Pre-Printed & Write-On Markers
- E4. Permanent Identification
- E5. Lockout/ Tagout & Safety Solutions
- F. Index

PANDUIT® ELECTRICAL SOLUTIONS

A.
System
Overview



Code Conductor, Two-Hole, Long Barrel with Window Lug, 90° Angle (continued)

B1.
Cable Ties

B2.
Cable
Accessories

B3.
Stainless
Steel Ties

C1.
Wiring
Duct

C2.
Surface
Raceway

C3.
Abrasion
Protection

C4.
Cable
Management

D1.
Terminals

D2.
Power
Connectors

D3.
Grounding
Connectors

E1.
Labeling
Systems

E2.
Labels

E3.
Pre-Printed
& Write-On
Markers

E4.
Permanent
Identification

E5.
Lockout/
Tagout
& Safety
Solutions

F.
Index

Part Number	Figure No.	Copper Conductor Size	Stud Hole Size (In.)	Stud Hole Spacing (In.)	Figure Dimensions (In.)				PANDUIT Color Code	PANDUIT Die Index No.‡	Burdny Die Index No.‡	T&B Die Index No.‡	Wire Strip Length (In.)	Std. Pkg. Qty.
					W	B	T	L						
LCC4-10AWF-L	1	#4 – 3 AWG STR, #2 AWG SOL	#10	.63	.55	1.05	.09	1.65	Gray	P29	8	29	1 1/8	50
LCC4-10BWF-L	1		#10	.75	.55	1.05	.09	1.78	Gray	P29	8	29	1 1/8	50
LCC4-14AWF-L	1		1/4	.63	.55	1.05	.09	1.74	Gray	P29	8	29	1 1/8	50
LCC4-14BWF-L	1		1/4	.75	.55	1.05	.09	1.87	Gray	P29	8	29	1 1/8	50
LCC4-38DWF-L	1	#2 AWG	3/8	1.00	.62	1.05	.08	2.34	Gray	P29	8	29	1 1/8	50
LCC2-10AWF-Q	1		#10	.63	.60	1.16	.10	1.76	Brown	P33	10	33	1 1/4	25
LCC2-10BWF-Q	1		#10	.75	.60	1.16	.10	1.89	Brown	P33	10	33	1 1/4	25
LCC2-14AWF-Q	1		1/4	.63	.60	1.16	.10	1.86	Brown	P33	10	33	1 1/4	25
LCC2-14BWF-Q	1		1/4	.75	.60	1.16	.10	1.99	Brown	P33	10	33	1 1/4	25
LCC2-14DWF-Q	1		1/4	1.00	.60	1.16	.10	2.24	Brown	P33	10	33	1 1/4	25
LCC2-56BWF-Q	1		5/16	.75	.66	1.16	.10	2.11	Brown	P33	10	33	1 1/4	25
LCC2-56CWF-Q	1		5/16	.88	.66	1.16	.10	2.24	Brown	P33	10	33	1 1/4	25
LCC2-38BWF-Q	1		3/8	.75	.66	1.16	.10	2.19	Brown	P33	10	33	1 1/4	25
LCC2-38CWF-Q	1		3/8	.88	.66	1.16	.10	2.31	Brown	P33	10	33	1 1/4	25
LCC2-38DWF-Q	1		3/8	1.00	.66	1.16	.10	2.44	Brown	P33	10	33	1 1/4	25
LCC2-38WF-Q	1		3/8	1.75	.66	1.16	.10	3.19	Brown	P33	10	33	1 1/4	25
LCC2-12WF-Q	1	1/2	1.75	.75	1.16	.08	3.61	Brown	P33	10	33	1 1/4	25	
LCC1-14AWF-E	1	#1 AWG	1/4	.63	.70	1.36	.11	1.94	Green	P37	11	37	1 7/16	20
LCC1-14BWF-E	1		1/4	.75	.70	1.36	.11	2.06	Green	P37	11	37	1 7/16	20
LCC1-56BWF-E	1		5/16	.75	.70	1.36	.11	2.19	Green	P37	11	37	1 7/16	20
LCC1-56CWF-E	1		5/16	.88	.70	1.36	.11	2.31	Green	P37	11	37	1 7/16	20
LCC1-38DWF-E	1		3/8	1.00	.70	1.36	.11	2.51	Green	P37	11	37	1 7/16	20
LCC1-12WF-E	1		1/2	1.75	.75	1.36	.09	3.68	Green	P37	11	37	1 7/16	20
LCC1/0-14AWF-X	1		1/4	.63	.76	1.44	.12	2.08	Pink	P42	12	42	1 1/2	10
LCC1/0-14BWF-X	1		1/4	.75	.76	1.44	.12	2.20	Pink	P42	12	42	1 1/2	10
LCC1/0-14DWF-X	1	1/0 AWG	1/4	1.00	.76	1.44	.12	2.45	Pink	P42	12	42	1 1/2	10
LCC1/0-38DWF-X	1		3/8	1.00	.76	1.44	.12	2.58	Pink	P42	12	42	1 1/2	10
LCC1/0-38WF-X	1		3/8	1.75	.76	1.44	.12	3.33	Pink	P42	12	42	1 1/2	10
LCC1/0-12DWF-X	1		1/2	1.00	.80	1.44	.12	2.85	Pink	P42	12	42	1 1/2	10
LCC1/0-12WF-X	1	1/2	1.75	.80	1.44	.12	3.75	Pink	P42	12	42	1 1/2	10	
LCC2/0-14AWF-X	1	2/0 AWG	1/4	.63	.85	1.50	.13	2.22	Black	P45	13	45	1 9/16	10
LCC2/0-14BWF-X	1		1/4	.75	.85	1.50	.13	2.34	Black	P45	13	45	1 9/16	10
LCC2/0-56DWF-X	1		5/16	1.00	.85	1.50	.13	2.59	Black	P45	13	45	1 9/16	10
LCC2/0-38DWF-X	1		3/8	1.00	.85	1.50	.13	2.66	Black	P45	13	45	1 9/16	10
LCC2/0-12DWF-X	1		1/2	1.00	.85	1.50	.13	2.91	Black	P45	13	45	1 9/16	10
LCC2/0-12WF-X	1		1/2	1.75	.85	1.50	.13	3.82	Black	P45	13	45	1 9/16	10
LCC3/0-14BWF-X	1	3/0 AWG	1/4	.75	.96	1.50	.13	2.42	Orange	P50	14	50	1 9/16	10
LCC3/0-56DWF-X	1		5/16	1.00	.96	1.50	.13	2.67	Orange	P50	14	50	1 9/16	10
LCC3/0-38DWF-X	1		3/8	1.00	.96	1.50	.13	2.73	Orange	P50	14	50	1 9/16	10
LCC3/0-12DWF-X	1		1/2	1.00	.96	1.50	.13	2.98	Orange	P50	14	50	1 9/16	10
LCC3/0-12WF-X	1	1/2	1.75	.96	1.50	.13	3.89	Orange	P50	14	50	1 9/16	10	
LCC4/0-14AWF-X	1	4/0 AWG	1/4	.63	1.06	1.56	.14	2.38	Purple	P54	15	54	1 5/8	10
LCC4/0-14BWF-X	1		1/4	.75	1.06	1.56	.14	2.50	Purple	P54	15	54	1 5/8	10
LCC4/0-56DWF-X	1		5/16	1.00	1.06	1.56	.14	2.77	Purple	P54	15	54	1 5/8	10
LCC4/0-38DWF-X	1		3/8	1.00	1.06	1.56	.14	2.84	Purple	P54	15	54	1 5/8	10
LCC4/0-38WF-X	1		3/8	1.75	1.06	1.56	.14	3.59	Purple	P54	15	54	1 5/8	10
LCC4/0-12DWF-X	1		1/2	1.00	1.06	1.56	.14	3.07	Purple	P54	15	54	1 5/8	10
LCC4/0-12WF-X	1		1/2	1.75	1.06	1.56	.14	3.98	Purple	P54	15	54	1 5/8	10

‡See pages D3.58 – D3.61 for tool and die information.

**Consult cable manufacturer for voltage stress relief instructions with applications greater than 2000 V.

◆NEMA hole sizes and spacing.



Code Conductor, Two-Hole, Long Barrel with Window Lug, 90° Angle (continued)

Part Number	Figure No.	Copper Conductor Size	Stud Hole Size (In.)	Stud Hole Spacing (In.)	Figure Dimensions (In.)				PANDUIT Color Code	PANDUIT Die Index No.‡	Bumdy Die Index No.‡	T&B Die Index No.‡	Wire Strip Length (In.)	Std. Pkg. Qty.
					W	B	T	L						
LCC250-56DWF-X	1	250 kcmil	5/16	1.00	1.17	1.61	.14	2.83	Yellow	P62	16	62	1 11/16	10
LCC250-38DWF-X	1		3/8	1.00	1.17	1.61	.14	2.90	Yellow	P62	16	62	1 11/16	10
LCC250-12DWF-X	1		1/2	1.00	1.17	1.61	.14	3.13	Yellow	P62	16	62	1 11/16	10
◆ LCC250-12WF-X	1		1/2	1.75	1.17	1.61	.14	4.04	Yellow	P62	16	62	1 11/16	10
LCC300-38DWF-X	1	300 kcmil	3/8	1.00	1.19	2.24	.16	2.88	White	P66	17	66	2 5/16	10
◆ LCC300-12WF-X	1		1/2	1.75	1.19	2.24	.16	4.06	White	P66	17	66	2 5/16	10
LCC350-14BWF-X	1	350 kcmil	1/4	.75	1.28	2.24	.17	2.46	Red	P71	18	71	2 5/16	10
LCC350-38DWF-X	1		3/8	1.00	1.28	2.24	.17	2.94	Red	P71	18	71	2 5/16	10
◆ LCC350-12WF-X	1		1/2	1.75	1.28	2.24	.17	4.12	Red	P71	18	71	2 5/16	10
LCC400-14BWF-6	1	400 kcmil	1/4	.75	1.39	2.30	.18	2.54	Blue	P76	19	76	2 3/8	6
LCC400-38DWF-6	1		3/8	1.00	1.39	2.30	.18	3.02	Blue	P76	19	76	2 3/8	6
◆ LCC400-12WF-6	1		1/2	1.75	1.39	2.30	.18	4.20	Blue	P76	19	76	2 3/8	6
LCC500-14BWF-6	1	500 kcmil	1/4	.75	1.54	2.50	.22	2.65	Brown	P87	20	87	2 9/16	6
LCC500-38DWF-6	1		3/8	1.00	1.54	2.50	.22	3.13	Brown	P87	20	87	2 9/16	6
◆ LCC500-12WF-6	1		1/2	1.75	1.54	2.50	.22	4.31	Brown	P87	20	87	2 9/16	6
LCC600-38DWF-6	1	600 kcmil	3/8	1.00	1.70	2.69	.26	3.26	Green	P94	22	94	2 3/4	6
◆ LCC600-12WF-6	1		1/2	1.75	1.70	2.69	.26	4.44	Green	P94	22	94	2 3/4	6

‡See pages D3.58 – D3.61 for tool and die information.

**Consult cable manufacturer for voltage stress relief instructions with applications greater than 2000 V.

◆NEMA hole sizes and spacing.



Code Conductor, Two-Hole, Long Barrel with Window, Narrow Tongue Lug

For Use with Stranded Copper Conductors

Type LCCN-W

- Narrow tongue width for limited space applications
- Long barrel maximizes number of crimps and provides premium wire pull-out strength and electrical performance
- Inspection window to visually assure full conductor insertion
- Color-coded barrels marked with PANDUIT and specified competitor die index numbers for proper crimp die selection
- Tin-plated to inhibit corrosion
- UL Listed and CSA Certified to 35 KV** and temperature rated to 90°C when crimped with PANDUIT and specified competitor crimping tools and dies
- UL Listed and CSA Certified for wide wire range-taking capability when crimped with PANDUIT® UNI-DIE™ Dieless Crimping Tools‡
- **Tested by Telcordia – meets NEBS Level 3**
- Meets J-STD-607-A and TIA-942 requirements for network systems grounding applications
- Available with NEMA hole sizes and spacing

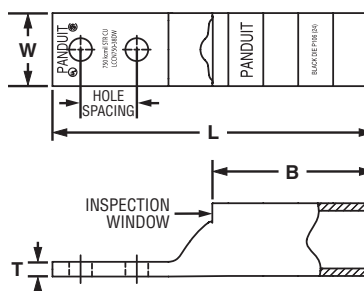

Part Number	Copper Conductor Size	Stud Hole Size (In.)	Stud Hole Spacing (In.)	Figure Dimensions (In.)				PANDUIT Color Code	PANDUIT Die Index No.‡	Bumdy Die Index No.‡	T&B Die Index No.‡	Wire Strip Length (In.)	Std. Pkg. Qty.
				W	B	T	L						
LCCN750-38DW-6	750 kcmil	3/8	1.00	1.30	2.88	.28	5.72	Black	P106	24	106	2 15/16	6
◆ LCCN750-12W-6	750 kcmil	1/2	1.75	1.30	2.88	.28	6.66	Black	P106	24	106	2 15/16	6

‡See pages D3.58 – D3.61 for tool and die information.

**Consult cable manufacturer for voltage stress relief instructions with applications greater than 2000 V.

◆NEMA hole sizes and spacing.

A. System Overview

B1. Cable Ties

B2. Cable Accessories

B3. Stainless Steel Ties

C1. Wiring Duct

C2. Surface Raceway

C3. Abrasion Protection

C4. Cable Management

D1. Terminals

D2. Power Connectors

D3. Grounding Connectors

E1. Labeling Systems

E2. Labels

E3. Pre-Printed & Write-On Markers

E4. Permanent Identification

E5. Lockout/Tagout & Safety Solutions

F. Index

A. System Overview



Code Conductor, Two-Hole, Long Barrel with Corona Relief Taper Lug

B1. Cable Ties

To Facilitate Use with Stranded Copper Conductors in Applications of 5000 V or More

Type LCCH

- Externally chamfered barrel end inhibits Corona effect when used in high voltage applications
- Long barrel maximizes number of crimps and provides premium wire pull-out strength and electrical performance
- Color-coded barrels marked with *PANDUIT* and specified competitor die index numbers for proper crimp die selection
- Enclosed barrel prevents corrosive material from entering barrel when used in harsh environments
- Tin-plated to inhibit corrosion
- UL Listed and CSA Certified to 35 KV** and temperature rated to 90°C when crimped with *PANDUIT* and specified competitor crimping tools and dies
- Available with NEMA hole sizes and spacing

C1. Wiring Duct



C2. Surface Raceway



Corona Relief Taper

C3. Abrasion Protection

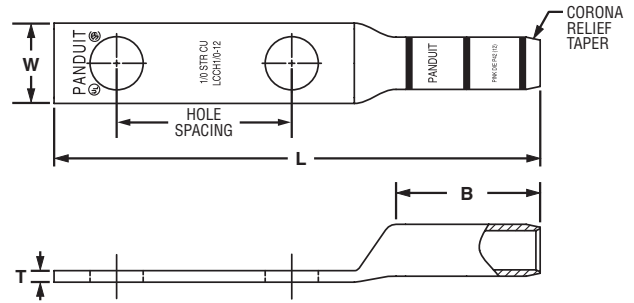

C4. Cable Management

D1. Terminals

D2. Power Connectors

D3. Grounding Connectors

Part Number	Copper Conductor Size	Stud Hole Size (In.)	Stud Hole Spacing (In.)	Figure Dimensions (In.)				PANDUIT Color Code	PANDUIT Die Index No.‡	Burndy Die Index No.‡	T&B Die Index No.‡	Wire Strip Length (In.)	Std. Pkg. Qty.
				W	B	T	L						
LCCH1/0-12-X	1/0 AWG	1/2	1.75	.80	1.44	.12	4.86	Pink	P42	12	42	1 1/2	10
LCCH2/0-12-X	2/0 AWG	1/2	1.75	.85	1.50	.13	4.98	Black	P45	13	45	1 9/16	10
LCCH3/0-12-X	3/0 AWG	1/2	1.75	.96	1.50	.13	5.03	Orange	P50	14	50	1 9/16	10
◆ LCCH4/0-12-X	4/0 AWG	1/2	1.75	1.06	1.56	.14	5.13	Purple	P54	15	54	1 5/8	10
◆ LCCH250-12-X	250 kcmil	1/2	1.75	1.17	1.61	.14	5.23	Yellow	P62	16	62	1 1/16	10
◆ LCCH300-12-X	300 kcmil	1/2	1.75	1.19	2.24	.16	5.94	White	P66	17	66	2 5/16	10
◆ LCCH350-12-X	350 kcmil	1/2	1.75	1.28	2.24	.17	5.99	Red	P71	18	71	2 5/16	10
◆ LCCH400-12-6	400 kcmil	1/2	1.75	1.39	2.30	.18	6.10	Blue	P76	19	76	2 3/8	6
◆ LCCH500-12-6	500 kcmil	1/2	1.75	1.54	2.50	.22	6.36	Brown	P87	20	87	2 9/16	6
◆ LCCH600-12-6	600 kcmil	1/2	1.75	1.70	2.69	.26	6.63	Green	P94	22	94	2 3/4	6
◆ LCCH750-12-6	750 kcmil	1/2	1.75	1.89	2.88	.26	7.04	Black	P106	24	106	2 15/16	6
◆ LCCH1000-12-3	1000 kcmil	1/2	1.75	2.17	3.00	.32	7.29	White	P125	27	125	3 1/16	3

‡See pages D3.62, D3.63 for tool and die information.

**Consult cable manufacturer for voltage stress relief instructions with applications greater than 2000 V.

◆NEMA hole sizes and spacing.

E1. Labeling Systems

E2. Labels

E3. Pre-Printed & Write-On Markers

E4. Permanent Identification

E5. Lockout/Tagout & Safety Solutions

F. Index



Code Conductor, Blank Tongue, Long Barrel Lug

For Use with Stranded Copper Conductors

Type LCC-00

- Long barrel maximizes number of crimps and provides premium wire pull-out strength and electrical performance
- Color-coded barrels marked with *PANDUIT* and specified competitor die index numbers for proper crimp die selection
- Enclosed barrel prevents corrosive material from entering barrel when used in harsh environments
- Tin-plated to inhibit corrosion
- UL Recognized and CSA Certified to 35 KV** and temperature rated to 90°C when crimped with *PANDUIT* and specified competitor crimping tools and dies

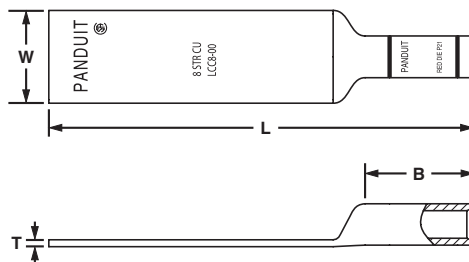

Figure 1

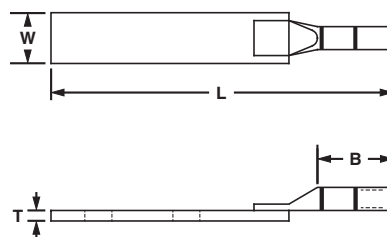

Figure 2: Two-Piece Brazed Tongue Construction

Part Number	Figure No.	Copper Conductor Size	Figure Dimensions (In.)				PANDUIT Color Code	PANDUIT Die Index No.	Burdny Die Index No.‡	T&B Die Index No.‡	Wire Strip Length (In.)	Std. Pkg. Qty.
			W	B	T	L						
LCC8-00-L	1	#8 AWG	.60	.70	.05	2.75	Red	P21	49	21	3/4	50
LCC6-00-L	2	#6 AWG	.75	1.13	.16	5.00	Blue	P24	7	24	1 1/8	50
LCC4-00-L	2	#4 – 3 AWG STR, #2 AWG SOL	.75	1.13	.16	5.06	Gray	P29	8	29	1 1/8	50
LCC2-00-Q	1	#2 AWG	.75	1.16	.08	4.51	Brown	P33	10	33	1 1/4	25
LCC1-00-E	1	#1 AWG	.75	1.36	.09	4.74	Green	P37	11	37	1 7/16	20
LCC1/0-00-X	1	1/0 AWG	.80	1.44	.12	4.86	Pink	P42	12	42	1 1/2	10
LCC2/0-00-X	1	2/0 AWG	.85	1.50	.13	4.98	Black	P45	13	45	1 9/16	10
LCC3/0-00-X	1	3/0 AWG	.96	1.50	.13	5.03	Orange	P50	14	50	1 9/16	10
LCC4/0-00-X	1	4/0 AWG	1.06	1.56	.14	5.13	Purple	P54	15	54	1 5/8	10
LCC250-00-X	1	250 kcmil	1.17	1.60	.14	5.23	Yellow	P62	16	62	1 11/16	10
LCC300-00-X	1	300 kcmil	1.19	2.23	.16	5.94	White	P66	17	66	2 5/16	10
LCC350-00-X	1	350 kcmil	1.28	2.23	.17	5.99	Red	P71	18	71	2 5/16	10
LCC400-00-6	1	400 kcmil	1.39	2.29	.18	6.10	Blue	P76	19	76	2 3/8	6
LCC500-00-6	1	500 kcmil	1.54	2.49	.22	6.36	Brown	P87	20	87	2 9/16	6
LCC600-00-6	1	600 kcmil	1.70	2.68	.26	6.63	Green	P94	22	94	2 3/4	6
LCC750-00-6	1	750 kcmil	1.89	2.87	.26	7.04	Black	P106	24	106	2 15/16	6
LCC1000-00-3	1	1000 kcmil	2.17	2.99	.32	7.29	White	P125	27	125	3 1/16	3

‡See pages D3.58 – D3.61 for tool and die information.

**Consult cable manufacturer for voltage stress relief instructions with applications greater than 2000 V.

A. System Overview

B1. Cable Ties

B2. Cable Accessories

B3. Stainless Steel Ties

C1. Wiring Duct

C2. Surface Raceway

C3. Abrasion Protection

C4. Cable Management

D1. Terminals

D2. Power Connectors

D3. Grounding Connectors

E1. Labeling Systems

E2. Labels

E3. Pre-Printed & Write-On Markers

E4. Permanent Identification

E5. Lockout/Tagout & Safety Solutions

F. Index

A. System Overview



Code Conductor, Blank Tongue, Long Barrel with Window Lug

B1. Cable Ties

For Use with Stranded Copper Conductors

Type LCC-00W

- Long barrel maximizes number of crimps and provides premium wire pull-out strength and electrical performance
- Inspection window to visually assure full conductor insertion
- Color-coded barrels marked with *PANDUIT* and specified competitor die index numbers for proper crimp die selection
- Enclosed barrel prevents corrosive material from entering barrel when used in harsh environments
- Tin-plated to inhibit corrosion
- UL Recognized and CSA Certified to 35 KV** and temperature rated to 90°C when crimped with *PANDUIT* and specified competitor crimping tools and dies

B2. Cable Accessories

B3. Stainless Steel Ties

C1. Wiring Duct

C2. Surface Raceway

C3. Abrasion Protection

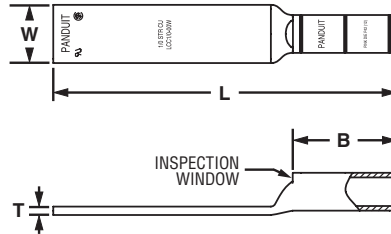

C4. Cable Management

Part Number	Copper Conductor Size	Figure Dimensions (In.)				PANDUIT Color Code	PANDUIT Die Index No.‡	Burndy Die Index No.‡	T&B Die Index No.‡	Wire Strip Length (In.)	Std. Pkg. Qty.
		W	B	T	L						
LCC8-00W-L	#8 AWG	.60	.70	.05	2.70	Red	P21	49	21	3/4	50
LCC6-00W-L	#6 AWG	.62	1.07	.06	3.08	Blue	P24	7	24	1 1/8	50
LCC4-00W-L	#4 AWG	.62	1.05	.08	3.09	Gray	P29	8	29	1 1/8	50
LCC2-00W-Q	#2 AWG	.75	1.16	.08	4.41	Brown	P33	10	33	1 1/4	25
LCC1-00W-E	#1 AWG	.75	1.36	.09	4.63	Green	P37	11	37	1 7/16	20
LCC1/0-00W-X	1/0 AWG	.80	1.44	.12	4.74	Pink	P42	12	42	1 1/2	10
LCC2/0-00W-X	2/0 AWG	.85	1.50	.13	4.83	Black	P45	13	45	1 9/16	10
LCC3/0-00W-X	3/0 AWG	.96	1.50	.13	4.87	Orange	P50	14	50	1 9/16	10
LCC4/0-00W-X	4/0 AWG	1.06	1.56	.14	4.95	Purple	P54	15	54	1 5/8	10
LCC250-00W-X	250 kcmil	1.17	1.61	.14	5.04	Yellow	P62	16	62	1 11/16	10
LCC300-00W-X	300 kcmil	1.19	2.24	.16	5.73	White	P66	17	66	2 5/16	10
LCC350-00W-X	350 kcmil	1.28	2.24	.17	5.77	Red	P71	18	71	2 5/16	10
LCC400-00W-6	400 kcmil	1.28	2.30	.17	5.85	Blue	P76	19	76	2 3/8	6
LCC500-00W-6	500 kcmil	1.54	2.50	.22	6.13	Brown	P87	20	87	2 9/16	6
LCC600-00W-6	600 kcmil	1.70	2.69	.26	6.37	Green	P94	22	94	2 3/4	6

D1. Terminals

D2. Power Connectors

D3. Grounding Connectors

E1. Labeling Systems

E2. Labels

E3. Pre-Printed & Write-On Markers

E4. Permanent Identification

E5. Lockout/Tagout & Safety Solutions

F. Index

‡See pages D3.58 – D3.61 for tool and die information.
 **Consult cable manufacturer for voltage stress relief instructions with applications greater than 2000 V.

UL LISTED CERTIFIED Code Conductor, Short Barrel, Butt Splice

For Use with Stranded Copper Conductors

Type SCSS

- Short barrel for limited space applications
- Color-coded barrels marked with *PANDUIT* and specified competitor die index numbers for proper crimp die selection
- Internal wire stops to prevent over-insertion of conductor
- Tin-plated to inhibit corrosion
- UL Listed and CSA Certified to 35 KV** and temperature rated to 90°C when crimped with *PANDUIT* and specified competitor crimping tools and dies
- **Tested by Telcordia – meets NEBS Level 3**

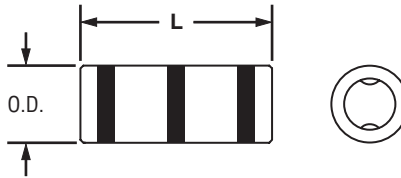

Part Number	Copper Conductor Size	Figure Dimensions (In.)		PANDUIT Color Code	PANDUIT Die Index No.‡	Burdny Die Index No.‡	T&B Die Index No.‡	Wire Strip Length (In.)	Std. Pkg. Qty.
		Barrel O.D.	L						
SCSS8-L	#8 AWG	.27	1.00	Red	P21	49	21	7/16	50
SCSS6-L	#6 AWG	.31	1.00	Blue	P24	7	24	7/16	50
SCSS4-L	#4 AWG	.38	1.00	Gray	P29	8	29	7/16	50
SCSS2-Q	#2 AWG	.42	1.25	Brown	P33	10	33	9/16	25
SCSS1-Q	#1 AWG	.46	1.44	Green	P37	11	37	11/16	25
SCSS1/0-X	1/0 AWG	.52	1.44	Pink	P42	12	42	11/16	10
SCSS2/0-X	2/0 AWG	.58	1.56	Black	P45	13	45	3/4	10
SCSS3/0-X	3/0 AWG	.64	1.69	Orange	P50	14	50	3/4	10
SCSS4/0-X	4/0 AWG	.71	1.81	Purple	P54	15	54	13/16	10
SCSS250-X	250 kcmil	.77	2.19	Yellow	P62	16	62	1 1/16	10

‡See pages D3.52, D3.53 for tool and die information.

**Consult cable manufacturer for voltage stress relief instructions with applications greater than 2000 V.

A. System Overview

B1. Cable Ties

B2. Cable Accessories

B3. Stainless Steel Ties

C1. Wiring Duct

C2. Surface Raceway

C3. Abrasion Protection

C4. Cable Management

D1. Terminals

D2. Power Connectors

D3. Grounding Connectors

E1. Labeling Systems

E2. Labels

E3. Pre-Printed & Write-On Markers

E4. Permanent Identification

E5. Lockout/Tagout & Safety Solutions

F. Index

A. System Overview



Code Conductor, Standard Barrel, Butt Splice

B1. Cable Ties

For Use with Stranded Copper Conductors

Type SCS

- Color-coded barrels marked with **PANDUIT** and specified competitor die index numbers for proper crimp die selection
- Internal wire stops to prevent over-insertion of conductor
- Tin-plated to inhibit corrosion
- UL Listed and CSA Certified to 35 KV** and temperature rated to 90°C when crimped with **PANDUIT** and specified competitor crimping tools and dies

- UL Listed and CSA Certified for wide wire range-taking capability when crimped with **PANDUIT® UNI-DIE™** Dieless Crimping Tools‡
- **Tested by Telcordia – meets NEBS Level 3**
- American Bureau of Shipping approved

B2. Cable Accessories

B3. Stainless Steel Ties

C1. Wiring Duct

C2. Surface Raceway

C3. Abrasion Protection

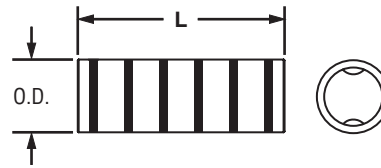

C4. Cable Management

Part Number	Copper Conductor Size	Figure Dimensions (In.)		PANDUIT Color Code	PANDUIT Die Index No.‡	Burdny Die Index No.‡	T&B Die Index No.‡	Wire Strip Length (In.)	Std. Pkg. Qty.
		Barrel O.D.	L						
SCS8-L	#8 AWG	.27	1.50	Red	P21	49	21	11/16	50
SCS6-L	#6 AWG	.31	1.75	Blue	P24	7	24	13/16	50
SCS4-L	#4 – 3 AWG STR, #2 AWG SOL	.38	1.75	Gray	P29	8	29	13/16	50
SCS2-Q	#2 AWG	.42	1.87	Brown	P33	10	33	7/8	25
SCS1-E	#1 AWG	.47	1.87	Green	P37	11	37	7/8	20
SCS1/0-X	1/0 AWG	.52	1.87	Pink	P42	12	42	7/8	10
SCS2/0-X	2/0 AWG	.58	2.00	Black	P45	13	45	15/16	10
SCS3/0-X	3/0 AWG	.64	2.12	Orange	P50	14	50	1	10
SCS4/0-X	4/0 AWG	.71	2.12	Purple	P54	15	54	1	10
SCS250-X	250 kcmil	.77	2.25	Yellow	P62	16	62	1 1/16	10
SCS300-X	300 kcmil	.81	2.25	White	P66	17	66	1 1/16	10
SCS350-X	350 kcmil	.87	2.37	Red	P71	18	71	1 1/8	10
SCS400-6	400 kcmil	.95	2.50	Blue	P76	19	76	1 3/16	6
SCS500-6	500 kcmil	1.05	2.87	Brown	P87	20	87	1 3/8	6
SCS600-6	600 kcmil	1.18	2.87	Green	P94	22	94	1 3/8	6
SCS750-6	750 kcmil	1.29	3.37	Black	P106	24	106	1 5/8	6
SCS1000-3	1000 kcmil	1.50	3.87	White	P125	27	125	1 7/8	3

‡See pages D3.54 – D3.57 for tool and die information.

**Consult cable manufacturer for voltage stress relief instructions with applications greater than 2000 V.

E3. Pre-Printed & Write-On Markers

E4. Permanent Identification

E5. Lockout/Tagout & Safety Solutions

F. Index

UL LISTED CERTIFIED Code Conductor, Long Barrel, Butt Splice

For Use with Stranded Copper Conductors

Type SCL

- Long barrel maximizes the number of crimps and provides premium wire pull-out strength and electrical performance
- Color-coded barrels marked with *PANDUIT* and specified competitor die index numbers for proper crimp die selection
- Internal wire stops to prevent over-insertion of conductor
- Tin-plated to inhibit corrosion
- UL Listed and CSA Certified to 35 KV** and temperature rated to 90°C when crimped with *PANDUIT* and specified competitor crimping tools and dies
- UL Listed and CSA Certified for wide wire range-taking capability when crimped with *PANDUIT*® *UNI-DIE*™ Dieless Crimping Tools‡
- **Tested by Telcordia – meets NEBS Level 3**

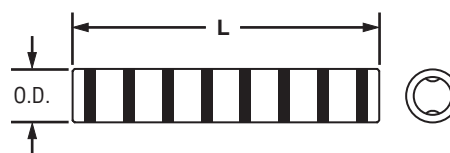

Part Number	Copper Conductor Size	Figure Dimensions (In.)		PANDUIT Color Code	PANDUIT Die Index No.‡	Burndy Die Index No.‡	T&B Die Index No.‡	Wire Strip Length (In.)	Std. Pkg. Qty.
		Barrel O.D.	L						
SCL8-L	#8 AWG	.27	2.25	Red	P21	49	21	1 1/16	50
SCL6-L	#6 AWG	.31	2.38	Blue	P24	7	24	1 1/8	50
SCL4-L	#4 – 3 AWG STR, #2 AWG SOL	.38	2.38	Gray	P29	8	29	1 1/8	50
SCL2-Q	#2 AWG	.42	2.62	Brown	P33	10	33	1 1/4	25
SCL1-E	#1 AWG	.47	2.87	Green	P37	11	37	1 3/8	20
SCL1/0-X	1/0 AWG	.52	2.87	Pink	P42	12	42	1 3/8	10
SCL2/0-X	2/0 AWG	.58	3.13	Black	P45	13	45	1 1/2	10
SCL3/0-X	3/0 AWG	.64	3.12	Orange	P50	14	54	1 1/2	10
SCL4/0-X	4/0 AWG	.71	3.37	Purple	P54	15	54	1 5/8	10
SCL250-X	250 kcmil	.77	3.38	Yellow	P62	16	62	1 5/8	10
SCL300-X	300 kcmil	.81	4.12	White	P66	17	66	2	10
SCL350-X	350 kcmil	.88	4.12	Red	P71	18	71	2	10
SCL400-6	400 kcmil	.95	4.37	Blue	P76	19	76	2 1/8	6
SCL500-6	500 kcmil	1.06	4.62	Brown	P87	20	87	2 1/4	6
SCL600-6	600 kcmil	1.19	5.50	Green	P94	22	94	2 11/16	6
SCL750-6	750 kcmil	1.30	5.87	Black	P106	24	106	2 7/8	6
SCL1000-3	1000 kcmil	1.50	6.12	White	P125	27	125	3	3

‡See pages D3.58 – D3.61 for tool and die information.

**Consult cable manufacturer for voltage stress relief instructions with applications greater than 2000 V.

A. System Overview

B1. Cable Ties

B2. Cable Accessories

B3. Stainless Steel Ties

C1. Wiring Duct

C2. Surface Raceway

C3. Abrasion Protection

C4. Cable Management

D1. Terminals

D2. Power Connectors

D3. Grounding Connectors

E1. Labeling Systems

E2. Labels

E3. Pre-Printed & Write-On Markers

E4. Permanent Identification

E5. Lockout/Tagout & Safety Solutions

F. Index

A.
System
Overview



Code Conductor, Long Barrel with Corona Relief Taper Splice

B1.
Cable Ties

To Facilitate Use with Stranded Copper Conductors in Applications of 5000 V or More

Type SCH

- Externally chamfered barrel end inhibits Corona effect when used in high voltage applications
- Color-coded barrels marked with *PANDUIT* and specified competitor die index numbers for proper crimp die selection
- Internal wire stops to prevent over-insertion of conductor
- Tin-plated to inhibit corrosion
- UL Listed and CSA Certified to 35 KV** and temperature rated to 90°C when crimped with *PANDUIT* and specified competitor crimping tools and dies

B2.
Cable
Accessories

B3.
Stainless
Steel Ties

C1.
Wiring
Duct

C2.
Surface
Raceway

C3.
Abrasion
Protection

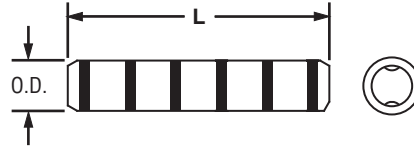

C4.
Cable
Management

Part Number	Copper Conductor Size	Figure Dimensions (In.)		PANDUIT Color Code	PANDUIT Die Index No.‡	Burdny Die Index No.‡	T&B Die Index No.‡	Wire Strip Length (In.)	Std. Pkg. Qty.
		Barrel O.D.	L						
SCH6-L	#6 AWG	.31	1.97	Blue	P24	7	24	15/16	50
SCH4-L	#4 AWG	.38	1.97	Gray	P29	8	29	15/16	50
SCH2-Q	#2 AWG	.42	2.13	Brown	P33	10	33	1	25
SCH1-E	#1 AWG	.47	2.13	Green	P37	11	37	1	20
SCH1/0-X	1/0 AWG	.52	2.13	Pink	P42	12	42	1	10
SCH2/0-X	2/0 AWG	.58	2.28	Black	P45	13	45	1 1/16	10
SCH3/0-X	3/0 AWG	.64	2.47	Orange	P50	14	50	1 3/16	10
SCH4/0-X	4/0 AWG	.71	2.54	Purple	P54	15	54	1 3/16	10
SCH250-X	250 kcmil	.77	2.63	Yellow	P62	16	62	1 1/4	10
SCH300-X	300 kcmil	.82	2.69	White	P66	17	66	2	10
SCH350-X	350 kcmil	.88	2.84	Red	P71	18	71	2	10
SCH500-6	500 kcmil	1.06	3.53	Brown	P87	20	87	2 1/4	6
SCH750-6	750 kcmil	1.30	4.28	Black	P106	24	106	2 7/8	6
SCH1000-3	1000 kcmil	1.50	5.06	White	P125	27	125	3	3

‡See pages D3.62, D3.63 for tool and die information.

**Consult cable manufacturer for voltage stress relief instructions with applications greater than 2000 V.

E2.
Labels

E3.
Pre-Printed
& Write-On
Markers

E4.
Permanent
Identification

E5.
Lockout/
Tagout/
& Safety
Solutions

F.
Index

Code Conductor, Long Barrel, T Splice

For Copper-to-Copper Stranded Conductors

Type SCT

- Provides a means of connecting the run conductor and taking off a perpendicular tap
- Long barrel maximizes number of crimps and provides premium wire pull-out strength and electrical performance

- Run conductor size and tap conductor size marked on each barrel
- 90°C temperature rated and for use up to 600 V when crimped with *PANDUIT* and specified competitor crimping tools and dies

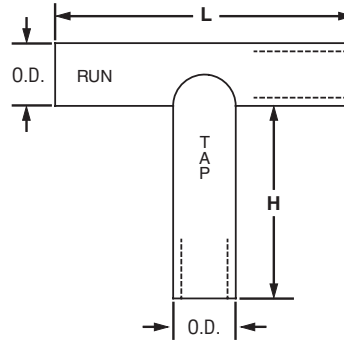

Part Number	Copper Conductor Size		Run O.D.	Tap O.D.	Figure Dimensions (In.)		PANDUIT Color Code and Die Index No.‡		Burdny Die Index No.‡	T&B Die Index No.‡	Wire Strip Length (In.)		Std. Pkg. Qty.
	Run	Tap			H	L	Run	Tap			Run	Tap	
SCT2-2	#2 AWG	#2 AWG	.42	.42	1.50	3.88	Brown P33	Brown P33	10	33	2	1 9/16	1
SCT1/0-1/0	1/0 AWG	1/0 AWG	.51	.51	1.50	4.00	Pink P42	Pink P42	12	42	2 1/16	1 9/16	1
SCT2/0-2/0	2/0 AWG	2/0 AWG	.56	.56	1.50	4.00	Black P45	Black P45	13	45	2 1/16	1 9/16	1
SCT4/0-1/0	4/0 AWG	1/0 AWG	.69	.51	1.50	4.00	Orange P50	Pink P42	14, 12	50, 42	2 1/16	1 9/16	1
SCT4/0-4/0	4/0 AWG	4/0 AWG	.69	.69	1.63	4.19	Purple P54	Purple P54	15	54	2 1/8	1 11/16	1
SCT250-250	250 kcmil	250 kcmil	.75	.75	1.63	4.25	Yellow P62	Yellow P62	16	62	2 3/16	1 11/16	1
SCT300-300	300 kcmil	300 kcmil	.81	.81	2.00	5.44	White P66	White P66	17	66	2 13/16	2 1/16	1
SCT350-350	350 kcmil	350 kcmil	.88	.88	2.00	5.50	Red P71	Red P71	18	71	2 13/16	2 1/16	1
SCT500-4/0	500 kcmil	4/0 AWG	1.06	.69	2.25	5.81	Brown P87	Purple P54	20, 15	87, 54	2 15/16	2 5/16	1
SCT500-500	500 kcmil	500 kcmil	1.06	1.06	2.50	6.06	Brown P87	Brown P87	20	87	3 1/8	2 9/16	1

‡See pages D3.64, D3.65 for tool and die information.

A. System Overview

B1. Cable Ties

B2. Cable Accessories

B3. Stainless Steel Ties

C1. Wiring Duct

C2. Surface Raceway

C3. Abrasion Protection

C4. Cable Management

D1. Terminals

D2. Power Connectors

D3. Grounding Connectors

E1. Labeling Systems

E2. Labels

E3. Pre-Printed & Write-On Markers

E4. Permanent Identification

E5. Lockout/Tagout & Safety Solutions

F. Index

A.
System
Overview



Code Conductor, Color-Coded Parallel Splice

B1.
Cable Ties

For Use with Stranded Copper Conductors

Type PSC

B2.
Cable
Accessories

- Industry recognized color-coding allows proper part selection and quick identification of crimping dies to speed installation
- Large easy-to-read part numbering for verification in demanding low light conditions
- Tin-plated to inhibit corrosion
- UL Listed and CSA Certified to 35 KV** and temperature rated to 90°C when crimped with *PANDUIT* dieless and die type crimping tools
- Single crimp design speeds installation and reduces labor costs
- Chamfered on both ends to facilitate fast and easy conductor insertion to speed installation

B3.
Stainless
Steel Ties

C1.
Wiring
Duct



C2.
Surface
Raceway

C3.
Abrasion
Protection

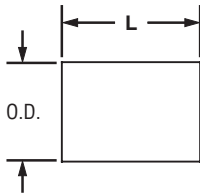

C4.
Cable
Management

Part Number	Figure Dimensions (in.)		PANDUIT Color Code	PANDUIT Die Index No.‡	Wire Strip Length (in.)	Std. Pkg. Qty.
	Barrel O.D.	L				
PSCRED-L	.27	.50	Red	P21	7/16	50
PSCBLU-L	.31	.50	Blue	P24	7/16	50
PSCGRY-L	.38	.50	Gray	P29	7/16	50
PSCBRN-L	.47	.62	Brown	P33	11/16	50
PSCGRN-L	.52	.62	Green	P37	11/16	50
PSCPNK-L	.58	.62	Pink	P42	11/16	50
PSCBLK-Q	.64	.81	Black	P45	7/8	25
PSCORG-Q	.71	.81	Orange	P50	7/8	25
PSCPUR-Q	.77	.88	Purple	P54	1	25
PSCYEL-Q	.81	1.05	Yellow	P62	1 1/16	25

‡See page D3.78 for tool and die information. For smaller wires sizes, see pages D1.65 – D1.69.

For heat shrink end caps and tubing see pages C3.33 – C3.39.

For thermal transfer labeling solutions see pages E1.1 – E2.30.

**Consult cable manufacturer for voltage stress relief instructions with applications greater than 2000 V.

D1.
Terminals

D2.
Power
Connectors

D3.
Grounding
Connectors

E1.
Labeling
Systems

E2.
Labels

E3.
Pre-Printed
& Write-On
Markers

E4.
Permanent
Identification

E5.
Lockout/
Tagout
& Safety
Solutions

F.
Index

Copper Compression Parallel Splice

How to Use This Guide

Example: (3) #14 AWG wires
(2) #12 AWG wires

- In Table 1 find #14 AWG wire size and # of wires on vertical axis.
- Find #12 AWG wire size and # of wires on horizontal axis.
- Find the intersection of ① and ② to identify the correct color coded splice, which corresponds to the part number in Table 2. blue = PSCBLU-L
- See Table 3 on reverse side for proper die index number, wire strip length, and number of crimps.



Part Number	Barrel O.D. (In.)	Length (In.)	PANDUIT Color Code	PANDUIT Die Index No.	Std. Pkg. Qty.
PSCRED-L	0.27	0.50	Red	P21	50
PSCBLU-L	0.31	0.50	Blue	P24	50
PSCGRY-L	0.38	0.50	Gray	P29	50
PSCBRN-L	0.47	0.62	Brown	P33	50
PSCGRN-L	0.52	0.62	Green	P37	50
PSCPNK-L	0.58	0.62	Pink	P42	50
PSCBLK-Q	0.64	0.81	Black	P45	25
PSCORG-Q	0.71	0.81	Orange	P50	25
PSCPUR-Q	0.77	0.88	Purple	P54	25
PSCYEL-Q	0.81	1.05	Yellow	P62	25

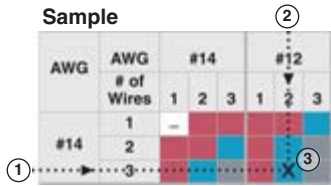

Table 2

AWG	AWG # of Wires	#14			#12			#10			#8			#6			#4			#2			#1			1/0			2/0			3/0		
		1	2	3	1	2	3	1	2	3	1	2	3	1	2	3	1	2	3	1	2	3	1	2	3	1	2	3	1	2	3			
#14	1	-	-	-	-	-	-	-	-	-	-	-	-	-	-	-	-	-	-	-	-	-	-	-	-	-	-	-	-	-	-			
	2	-	-	-	-	-	-	-	-	-	-	-	-	-	-	-	-	-	-	-	-	-	-	-	-	-	-	-	-	-	-			
	3	-	-	-	-	-	-	-	-	-	-	-	-	-	-	-	-	-	-	-	-	-	-	-	-	-	-	-	-	-	-			
#12	1	-	-	-	-	-	-	-	-	-	-	-	-	-	-	-	-	-	-	-	-	-	-	-	-	-	-	-	-	-	-			
	2	-	-	-	-	-	-	-	-	-	-	-	-	-	-	-	-	-	-	-	-	-	-	-	-	-	-	-	-	-	-			
	3	-	-	-	-	-	-	-	-	-	-	-	-	-	-	-	-	-	-	-	-	-	-	-	-	-	-	-	-	-	-			
#10	1	-	-	-	-	-	-	-	-	-	-	-	-	-	-	-	-	-	-	-	-	-	-	-	-	-	-	-	-	-	-			
	2	-	-	-	-	-	-	-	-	-	-	-	-	-	-	-	-	-	-	-	-	-	-	-	-	-	-	-	-	-	-			
	3	-	-	-	-	-	-	-	-	-	-	-	-	-	-	-	-	-	-	-	-	-	-	-	-	-	-	-	-	-	-			
#8	1	-	-	-	-	-	-	-	-	-	-	-	-	-	-	-	-	-	-	-	-	-	-	-	-	-	-	-	-	-	-			
	2	-	-	-	-	-	-	-	-	-	-	-	-	-	-	-	-	-	-	-	-	-	-	-	-	-	-	-	-	-	-			
	3	-	-	-	-	-	-	-	-	-	-	-	-	-	-	-	-	-	-	-	-	-	-	-	-	-	-	-	-	-	-			
#6	1	-	-	-	-	-	-	-	-	-	-	-	-	-	-	-	-	-	-	-	-	-	-	-	-	-	-	-	-	-	-			
	2	-	-	-	-	-	-	-	-	-	-	-	-	-	-	-	-	-	-	-	-	-	-	-	-	-	-	-	-	-	-			
	3	-	-	-	-	-	-	-	-	-	-	-	-	-	-	-	-	-	-	-	-	-	-	-	-	-	-	-	-	-	-			
#4	1	-	-	-	-	-	-	-	-	-	-	-	-	-	-	-	-	-	-	-	-	-	-	-	-	-	-	-	-	-	-			
	2	-	-	-	-	-	-	-	-	-	-	-	-	-	-	-	-	-	-	-	-	-	-	-	-	-	-	-	-	-	-			
	3	-	-	-	-	-	-	-	-	-	-	-	-	-	-	-	-	-	-	-	-	-	-	-	-	-	-	-	-	-	-			
#2	1	-	-	-	-	-	-	-	-	-	-	-	-	-	-	-	-	-	-	-	-	-	-	-	-	-	-	-	-	-	-			
	2	-	-	-	-	-	-	-	-	-	-	-	-	-	-	-	-	-	-	-	-	-	-	-	-	-	-	-	-	-	-			
	3	-	-	-	-	-	-	-	-	-	-	-	-	-	-	-	-	-	-	-	-	-	-	-	-	-	-	-	-	-	-			
#1	1	-	-	-	-	-	-	-	-	-	-	-	-	-	-	-	-	-	-	-	-	-	-	-	-	-	-	-	-	-	-			
	2	-	-	-	-	-	-	-	-	-	-	-	-	-	-	-	-	-	-	-	-	-	-	-	-	-	-	-	-	-	-			
	3	-	-	-	-	-	-	-	-	-	-	-	-	-	-	-	-	-	-	-	-	-	-	-	-	-	-	-	-	-	-			
1/0	1	-	-	-	-	-	-	-	-	-	-	-	-	-	-	-	-	-	-	-	-	-	-	-	-	-	-	-	-	-	-			
	2	-	-	-	-	-	-	-	-	-	-	-	-	-	-	-	-	-	-	-	-	-	-	-	-	-	-	-	-	-	-			
	3	-	-	-	-	-	-	-	-	-	-	-	-	-	-	-	-	-	-	-	-	-	-	-	-	-	-	-	-	-	-			
2/0	1	-	-	-	-	-	-	-	-	-	-	-	-	-	-	-	-	-	-	-	-	-	-	-	-	-	-	-	-	-	-			
	2	-	-	-	-	-	-	-	-	-	-	-	-	-	-	-	-	-	-	-	-	-	-	-	-	-	-	-	-	-	-			
	3	-	-	-	-	-	-	-	-	-	-	-	-	-	-	-	-	-	-	-	-	-	-	-	-	-	-	-	-	-	-			
3/0	1	-	-	-	-	-	-	-	-	-	-	-	-	-	-	-	-	-	-	-	-	-	-	-	-	-	-	-	-	-	-			
	2	-	-	-	-	-	-	-	-	-	-	-	-	-	-	-	-	-	-	-	-	-	-	-	-	-	-	-	-	-	-			
	3	-	-	-	-	-	-	-	-	-	-	-	-	-	-	-	-	-	-	-	-	-	-	-	-	-	-	-	-	-	-			

Table 1

A. System Overview

B1. Cable Ties

B2. Cable Accessories

B3. Stainless Steel Ties

C1. Wiring Duct

C2. Surface Raceway

C3. Abrasion Protection

C4. Cable Management

D1. Terminals

D2. Power Connectors

D3. Grounding Connectors

E1. Labeling Systems

E2. Labels

E3. Pre-Printed & Write-On Markers

E4. Permanent Identification

E5. Lockout/Tagout & Safety Solutions

F. Index

UL LISTED **CSA CERTIFIED** **Flex Conductor, One-Hole, Standard Barrel with Window Lug**

For Use with Flexible, Extra-Flexible, and Code Stranded Copper Conductors

Type LCAX

- Can be used with code conductor and flex conductor class: G, H, I, K, M and Diesel Locomotive
- Generously beveled wire entry prevents bent back strands when inserting conductor into barrel
- Color-coded barrels marked with *PANDUIT* and specified competitor die index numbers for proper crimp die selection
- Inspection window to visually assure full conductor insertion
- Tin-plated to inhibit corrosion
- UL Listed and CSA Certified to 35 KV** and temperature rated to 90°C when crimped with *PANDUIT* and specified competitor crimping tools and dies
- American Bureau of Shipping approved

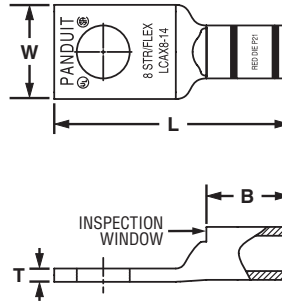

Part Number	Flex Conductor Size		Code Conductor Size	Stud Hole Size (In.)	Figure Dimensions (In.)				PANDUIT Color Code	PANDUIT Die Index No.‡	Burdny Die Index No.‡	T&B Die Index No.‡	Wire Strip Length (In.)	Std. Pkg. Qty.
	Class G, H, I, K, M	Diesel Locomotive			W	B	T	L						
LCAX8-10-L	#8 AWG	#8 AWG	#8 AWG	#10	.41	.42	.08	1.11	Red	P21	49	21	1/2	50
LCAX8-14-L				1/4	.48	.42	.07	1.20	Red	P21	49	21	1/2	50
LCAX8-56-L				5/16	.56	.42	.05	1.32	Red	P21	49	21	1/2	50
LCAX8-38-L				3/8	.60	.42	.05	1.42	Red	P21	49	21	1/2	50
LCAX6-10-L	#6 AWG	#6 AWG	#6 AWG	#10	.45	.48	.09	1.19	Blue	P24	7	24	9/16	50
LCAX6-14-L				1/4	.48	.48	.08	1.28	Blue	P24	7	24	9/16	50
LCAX6-56-L				5/16	.56	.48	.07	1.40	Blue	P24	7	24	9/16	50
LCAX6-38-L				3/8	.62	.48	.06	1.50	Blue	P24	7	24	9/16	50
LCAX4-10-L	#4 AWG	#5, #4, #3 AWG	#4 AWG	#10	.55	.53	.09	1.26	Gray	P29	8	29	5/8	50
LCAX4-14-L				1/4	.55	.53	.09	1.35	Gray	P29	8	29	5/8	50
LCAX4-56-L				5/16	.55	.53	.09	1.47	Gray	P29	8	29	5/8	50
LCAX4-38-L				3/8	.62	.53	.07	1.57	Gray	P29	8	29	5/8	50
LCAX2-10-E*	#2 AWG	#2 AWG	#2 AWG	#10	.70	.59	.11	1.40	Brown	P33	10	33	11/16	20
LCAX2-14-E*				1/4	.70	.59	.11	1.50	Brown	P33	10	33	11/16	20
LCAX2-56-E*				5/16	.70	.59	.11	1.63	Brown	P33	10	33	11/16	20
LCAX2-38-E*				3/8	.70	.59	.11	1.70	Brown	P33	10	33	11/16	20
LCAX2-12-E*	1/2	.75	.59	.09	1.94	Brown	P33	10	33	11/16	20			
LCAX1-10-X	#1 AWG	#1 AWG	#1 AWG	#10	.76	.66	.12	1.50	Green	P37	11	37	3/4	10
LCAX1-14-X				1/4	.76	.66	.12	1.67	Green	P37	11	37	3/4	10
LCAX1-56-X				5/16	.76	.66	.12	1.72	Green	P37	11	37	3/4	10
LCAX1-38-X				3/8	.76	.66	.12	1.80	Green	P37	11	37	3/4	10
LCAX1-12-X	1/2	.80	.66	.12	2.03	Green	P37	11	37	3/4	10			
LCAX1/0-14-X	1/0 AWG	1/0 AWG	1/0 AWG	1/4	.85	.72	.13	1.82	Pink	P42	12	42	3/4	10
LCAX1/0-56-X				5/16	.85	.72	.13	1.82	Pink	P42	12	42	3/4	10
LCAX1/0-38-X				3/8	.85	.72	.13	1.89	Pink	P42	12	42	3/4	10
LCAX1/0-12-X				1/2	.85	.72	.13	2.14	Pink	P42	12	42	3/4	10

‡See pages D3.66 – D3.69 for tool and die information.

*Not UL Listed or CSA Certified with Class K flex conductor when crimped with Burdny tools.

**Consult cable manufacturer for voltage stress relief instructions with applications greater than 2000 V.



Flex Conductor, One-Hole, Standard Barrel with Window Lug (continued)

Part Number	Flex Conductor Size		Code Conductor Size	Stud Hole Size (In.)	Figure Dimensions (In.)				PANDUIT Color Code	PANDUIT Die Index No.‡	Burdny Die Index No.‡	T&B Die Index No.‡	Wire Strip Length (In.)	Std. Pkg. Qty.
	Class G, H, I, K, M	Diesel Locomotive			W	B	T	L						
LCAX2/0-10-X	2/0 AWG	2/0 AWG	2/0 AWG	#10	.96	.83	.13	1.72	Black	P45	13	45	7/8	10
LCAX2/0-14-X				1/4	.96	.83	.13	1.97	Black	P45	13	45	7/8	10
LCAX2/0-56-X				5/16	.96	.83	.13	1.97	Black	P45	13	45	7/8	10
LCAX2/0-38-X				3/8	.96	.83	.13	2.03	Black	P45	13	45	7/8	10
LCAX2/0-12-X				1/2	.96	.83	.13	2.28	Black	P45	13	45	7/8	10
LCAX2/0-58-X				5/8	.96	.83	.13	2.52	Black	P45	13	45	7/8	10
LCAX2/0-34-X				3/4	.96	.83	.13	2.88	Black	P45	13	45	7/8	10
LCAX3/0-10-X	3/0 AWG	3/0 AWG	3/0 AWG	#10	1.06	.91	.14	1.84	Orange	P50	14	50	1	10
LCAX3/0-14-X				1/4	1.06	.91	.14	2.08	Orange	P50	14	50	1	10
LCAX3/0-56-X				5/16	1.06	.91	.14	2.10	Orange	P50	14	50	1	10
LCAX3/0-38-X				3/8	1.06	.91	.14	2.17	Orange	P50	14	50	1	10
LCAX3/0-12-X				1/2	1.06	.91	.14	2.40	Orange	P50	14	50	1	10
LCAX4/0-14-X	4/0 AWG	4/0 AWG	4/0 AWG	1/4	1.19	1.03	.16	2.30	Purple	P54	15	54	1 1/16	10
LCAX4/0-56-X				5/16	1.19	1.03	.16	2.53	Purple	P54	15	54	1 1/16	10
LCAX4/0-38-X				3/8	1.19	1.03	.16	2.53	Purple	P54	15	54	1 1/16	10
LCAX4/0-12-X				1/2	1.19	1.03	.16	2.64	Purple	P54	15	54	1 1/16	10
LCAX4/0-58-X				5/8	1.19	1.03	.16	2.85	Purple	P54	15	54	1 1/16	10
LCAX4/0-34-X				3/4	1.19	1.03	.16	3.04	Purple	P54	15	54	1 1/16	10
LCAX250-14-X	250 kcmil	262.6 kcmil	—	1/4	1.28	1.03	.17	2.34	Yellow	P62	16	62	1 1/16	10
LCAX250-56-X				5/16	1.28	1.03	.17	2.57	Yellow	P62	16	62	1 1/16	10
LCAX250-38-X				3/8	1.28	1.03	.17	2.57	Yellow	P62	16	62	1 1/16	10
LCAX250-12-X				1/2	1.28	1.03	.17	2.68	Yellow	P62	16	62	1 1/16	10
LCAX250-58-X				5/8	1.28	1.03	.17	2.89	Yellow	P62	16	62	1 1/16	10
LCAX250-34-X				3/4	1.28	1.03	.17	3.08	Yellow	P62	16	62	1 1/16	10
LCAX300-38-6	300 kcmil	313.1 kcmil	—	3/8	1.39	1.19	.18	2.91	Red	P71	18	71H	1 1/4	6
LCAX300-12-6				1/2	1.39	1.19	.18	2.91	Red	P71	18	71H	1 1/4	6
LCAX300-58-6				5/8	1.39	1.19	.18	3.12	Red	P71	18	71H	1 1/4	6
LCAX350-56-6	350 kcmil	373.7 kcmil	—	5/16	1.54	1.29	.22	2.93	Blue	P76	19	76H	1 3/8	6
LCAX350-38-6				3/8	1.54	1.29	.22	2.93	Blue	P76	19	76H	1 3/8	6
LCAX350-12-6				1/2	1.54	1.29	.22	3.09	Blue	P76	19	76H	1 3/8	6
LCAX350-58-6	5/8	1.54	1.29	.22	3.30	Blue	P76	19	76H	1 3/8	6			
LCAX450-12-6	450 kcmil	444.4 kcmil	—	1/2	1.70	1.40	.26	3.60	Brown	P87	20	87H	1 7/16	6
LCAX450-58-6				5/8	1.70	1.40	.26	3.73	Brown	P87	20	87H	1 7/16	6
LCAX500-56-6	500 kcmil	535.3 kcmil	—	5/16	1.89	1.48	.26	3.27	Pink	P99	L99	99H	1 9/16	6
LCAX500-38-6				3/8	1.89	1.48	.26	3.27	Pink	P99	L99	99H	1 9/16	6
LCAX500-12-6				1/2	1.89	1.48	.26	3.64	Pink	P99	L99	99H	1 9/16	6
LCAX500-58-6				5/8	1.89	1.48	.26	4.20	Pink	P99	L99	99H	1 9/16	6
LCAX650-56-6	—	646.4 kcmil	—	5/16	1.95	1.45	.30	3.27	Black	P106	24	106H	1 1/2	6
LCAX650-38-6				3/8	1.95	1.45	.30	3.27	Black	P106	24	106H	1 1/2	6
LCAX650-12-6				1/2	1.95	1.45	.30	3.64	Black	P106	24	106H	1 1/2	6
LCAX650-58-6				5/8	1.95	1.45	.30	4.20	Black	P106	24	106H	1 1/2	6
LCAX750-12-3	—	777.7 kcmil	—	1/2	2.17	1.66	.32	3.94	Yellow	P115	L115	115H	1 3/4	3
LCAX750-58-3				5/8	2.17	1.66	.32	4.59	Yellow	P115	L115	115H	1 3/4	3

‡See pages D3.66 – D3.69 for tool and die information.

**Consult cable manufacturer for voltage stress relief instructions with applications greater than 2000 V.

A.
System
Overview

B1.
Cable
Ties

B2.
Cable
Accessories

B3.
Stainless
Steel
Ties

C1.
Wiring
Duct

C2.
Surface
Raceway

C3.
Abrasion
Protection

C4.
Cable
Management

D1.
Terminals

D2.
Power
Connectors

D3.
Grounding
Connectors

E1.
Labeling
Systems

E2.
Labels

E3.
Pre-Printed
& Write-On
Markers

E4.
Permanent
Identification

E5.
Lockout/
Tagout
& Safety
Solutions

F.
Index

A. System Overview

B1. Cable Ties

B2. Cable Accessories

B3. Stainless Steel Ties

C1. Wiring Duct

C2. Surface Raceway

C3. Abrasion Protection

C4. Cable Management

D1. Terminals

D2. Power Connectors

D3. Grounding Connectors

E1. Labeling Systems

E2. Labels

E3. Pre-Printed & Write-On Markers

E4. Permanent Identification

E5. Lockout/Tagout & Safety Solutions

F. Index

UL LISTED **CSA CERTIFIED** **Flex Conductor, One-Hole, Standard Barrel with Window Lug, 45° Angle**

For Use with Flexible, Extra-Flexible, and Code Stranded Copper Conductors

Type LCAX-H

- Can be used with code conductor and flex conductor class: G, H, I, K, M and Diesel Locomotive
- Generously beveled wire entry prevents bent back strands when inserting conductor into barrel
- Color-coded barrels marked with *PANDUIT* and specified competitor die index numbers for proper crimp die selection
- Inspection window to visually assure full conductor insertion
- Tin-plated to inhibit corrosion
- UL Listed and CSA Certified to 35 KV** and temperature rated to 90°C when crimped with *PANDUIT* and specified competitor crimping tools and dies
- American Bureau of Shipping approved

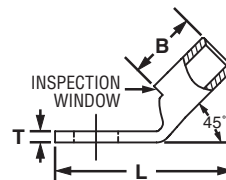
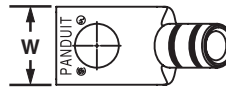

Part Number	Flex Conductor Size		Code Conductor Size	Stud Hole Size (In.)	Figure Dimensions (In.)				PANDUIT Color Code	PANDUIT Die Index No.‡	Burndy Die Index No.‡	T&B Die Index No.‡	Wire Strip Length (In.)	Std. Pkg. Qty.
	Class G, H, I, K, M	Diesel Locomotive			W	B	T	L						
LCAX8-10H-L	#8 AWG	#8 AWG	#8 AWG	#10	.41	.42	.08	1.00	Red	P21	49	21	1/2	50
LCAX8-14H-L				1/4	.48	.42	.07	1.09	Red	P21	49	21	1/2	50
LCAX8-56H-L				5/16	.56	.42	.05	1.20	Red	P21	49	21	1/2	50
LCAX8-38H-L				3/8	.60	.42	.05	1.30	Red	P21	49	21	1/2	50
LCAX6-10H-L	#6 AWG	#6 AWG	#6 AWG	#10	.45	.48	.09	1.06	Blue	P24	7	24	9/16	50
LCAX6-14H-L				1/4	.48	.48	.08	1.14	Blue	P24	7	24	9/16	50
LCAX6-56H-L				5/16	.56	.48	.07	1.26	Blue	P24	7	24	9/16	50
LCAX6-38H-L				3/8	.62	.48	.06	1.35	Blue	P24	7	24	9/16	50
LCAX4-10H-L	#4 AWG	#5, #4, #3 AWG	#4 AWG	#10	.55	.53	.09	1.12	Gray	P29	8	29	5/8	50
LCAX4-14H-L				1/4	.55	.53	.09	1.21	Gray	P29	8	29	5/8	50
LCAX4-56H-L				5/16	.55	.53	.09	1.33	Gray	P29	8	29	5/8	50
LCAX4-38H-L				3/8	.62	.53	.07	1.42	Gray	P29	8	29	5/8	50
LCAX2-10H-E*	#2 AWG	#2 AWG	#2 AWG	#10	.70	.59	.11	1.22	Brown	P33	10	33	11/16	20
LCAX2-14H-E*				1/4	.70	.59	.11	1.29	Brown	P33	10	33	11/16	20
LCAX2-56H-E*				5/16	.70	.59	.11	1.42	Brown	P33	10	33	11/16	20
LCAX2-38H-E*				3/8	.70	.59	.11	1.49	Brown	P33	10	33	11/16	20
LCAX2-12H-E*				1/2	.75	.59	.09	1.73	Brown	P33	10	33	11/16	20
LCAX1-10H-X	#1 AWG	#1 AWG	#1 AWG	#10	.76	.66	.12	1.43	Green	P37	11	37	3/4	10
LCAX1-14H-X				1/4	.76	.66	.12	1.43	Green	P37	11	37	3/4	10
LCAX1-56H-X				5/16	.76	.66	.12	1.49	Green	P37	11	37	3/4	10
LCAX1-38H-X				3/8	.76	.66	.12	1.56	Green	P37	11	37	3/4	10
LCAX1-12H-X				1/2	.80	.66	.12	1.80	Green	P37	11	37	3/4	10
LCAX1/0-14H-X	1/0 AWG	1/0 AWG	1/0 AWG	1/4	.85	.72	.13	1.58	Pink	P42	12	42	3/4	10
LCAX1/0-56H-X				5/16	.85	.72	.13	1.58	Pink	P42	12	42	3/4	10
LCAX1/0-38H-X				3/8	.85	.72	.13	1.64	Pink	P42	12	42	3/4	10
LCAX1/0-12H-X				1/2	.85	.72	.13	1.89	Pink	P42	12	42	3/4	10

‡See pages D3.66 – D3.69 for tool and die information.

*Not UL Listed or CSA Certified with Class K flex conductor when crimped with Burndy tools.

**Consult cable manufacturer for voltage stress relief instructions with applications greater than 2000 V.



Flex Conductor, One-Hole, Standard Barrel with Window Lug, 45° Angle (continued)

Part Number	Flex Conductor Size		Code Conductor Size	Stud Hole Size (In.)	Figure Dimensions (In.)				PANDUIT Color Code	PANDUIT Die Index No.‡	Burndy Die Index No.‡	T&B Die Index No.‡	Wire Strip Length (In.)	Std. Pkg. Qty.
	Class G, H, I, K, M	Diesel Locomotive			W	B	T	L						
LCAX2/0-10H-X	2/0 AWG	2/0 AWG	2/0 AWG	#10	.96	.83	.13	1.56	Black	P45	13	45	7/8	10
LCAX2/0-14H-X				1/4	.96	.83	.13	1.68	Black	P45	13	45	7/8	10
LCAX2/0-56H-X				5/16	.96	.83	.13	1.68	Black	P45	13	45	7/8	10
LCAX2/0-38H-X				3/8	.96	.83	.13	1.74	Black	P45	13	45	7/8	10
LCAX2/0-12H-X				1/2	.96	.83	.13	1.99	Black	P45	13	45	7/8	10
LCAX2/0-58H-X				5/8	.96	.83	.13	2.28	Black	P45	13	45	7/8	10
LCAX2/0-34H-X				3/4	.96	.83	.13	2.12	Black	P45	13	45	7/8	10
LCAX3/0-10H-X	3/0 AWG	3/0 AWG	3/0 AWG	#10	1.06	.91	.14	1.77	Orange	P50	14	50	1	10
LCAX3/0-14H-X				1/4	1.06	.91	.14	1.77	Orange	P50	14	50	1	10
LCAX3/0-56H-X				5/16	1.06	.91	.14	1.78	Orange	P50	14	50	1	10
LCAX3/0-38H-X				3/8	1.06	.91	.14	1.85	Orange	P50	14	50	1	10
LCAX3/0-12H-X				1/2	1.06	.91	.14	2.08	Orange	P50	14	50	1	10
LCAX4/0-14H-X	4/0 AWG	4/0 AWG	4/0 AWG	1/4	1.19	1.03	.16	2.03	Purple	P54	15	54	1 1/16	10
LCAX4/0-56H-X				5/16	1.19	1.03	.16	2.26	Purple	P54	15	54	1 1/16	10
LCAX4/0-38H-X				3/8	1.19	1.03	.16	2.26	Purple	P54	15	54	1 1/16	10
LCAX4/0-12H-X				1/2	1.19	1.03	.16	2.37	Purple	P54	15	54	1 1/16	10
LCAX4/0-58H-X				5/8	1.19	1.03	.16	2.58	Purple	P54	15	54	1 1/16	10
LCAX4/0-34H-X				3/4	1.19	1.03	.16	2.58	Purple	P54	15	54	1 1/16	10
LCAX250-14H-X	250 kcmil	262.6 kcmil	—	1/4	1.28	1.03	.17	2.30	Yellow	P62	16	62	1 1/16	10
LCAX250-56H-X				5/16	1.28	1.03	.17	2.30	Yellow	P62	16	62	1 1/16	10
LCAX250-38H-X				3/8	1.28	1.03	.17	2.30	Yellow	P62	16	62	1 1/16	10
LCAX250-12H-X				1/2	1.28	1.03	.17	2.41	Yellow	P62	16	62	1 1/16	10
LCAX250-58H-X				5/8	1.28	1.03	.17	2.62	Yellow	P62	16	62	1 1/16	10
LCAX250-34H-X				3/4	1.28	1.03	.17	2.62	Yellow	P62	16	62	1 1/16	10
LCAX300-38H-6	300 kcmil	313.1 kcmil	—	3/8	1.39	1.19	.18	2.64	Red	P71	18	71H	1 1/4	6
LCAX300-12H-6				1/2	1.39	1.19	.18	2.64	Red	P71	18	71H	1 1/4	6
LCAX300-58H-6				5/8	1.39	1.19	.18	2.85	Red	P71	18	71H	1 1/4	6
LCAX350-56H-6	350 kcmil	373.7 kcmil	—	5/16	1.54	1.29	.22	2.62	Blue	P76	19	76H	1 3/8	6
LCAX350-38H-6				3/8	1.54	1.29	.22	2.62	Blue	P76	19	76H	1 3/8	6
LCAX350-12H-6				1/2	1.54	1.29	.22	2.78	Blue	P76	19	76H	1 3/8	6
LCAX350-58H-6				5/8	1.54	1.29	.22	2.99	Blue	P76	19	76H	1 3/8	6
LCAX450-12H-6	450 kcmil	444.4 kcmil	—	1/2	1.70	1.40	.26	3.26	Brown	P87	20	87H	1 7/16	6
LCAX450-58H-6				5/8	1.70	1.40	.26	3.39	Brown	P87	20	87H	1 7/16	6
LCAX500-56H-6	500 kcmil	535.3 kcmil	—	5/16	1.89	1.48	.26	2.87	Pink	P99	L99	99H	1 9/16	6
LCAX500-38H-6				3/8	1.89	1.48	.26	2.87	Pink	P99	L99	99H	1 9/16	6
LCAX500-12H-6				1/2	1.89	1.48	.26	3.24	Pink	P99	L99	99H	1 9/16	6
LCAX500-58H-6				5/8	1.89	1.48	.26	3.80	Pink	P99	L99	99H	1 9/16	6
LCAX650-56H-6	—	646.4 kcmil	—	5/16	1.95	1.45	.30	2.89	Black	P106	24	106H	1 1/2	6
LCAX650-38H-6				3/8	1.95	1.45	.30	2.89	Black	P106	24	106H	1 1/2	6
LCAX650-12H-6				1/2	1.95	1.45	.30	3.26	Black	P106	24	106H	1 1/2	6
LCAX650-58H-6				5/8	1.95	1.45	.30	3.82	Black	P106	24	106H	1 1/2	6
LCAX750-12H-3	—	777.7 kcmil	—	1/2	2.17	1.66	.32	3.52	Yellow	P115	L115	115H	1 3/4	3
LCAX750-58H-3				5/8	2.17	1.66	.32	4.18	Yellow	P115	L115	115H	1 3/4	3

‡See pages D3.66 – D3.69 for tool and die information.

**Consult cable manufacturer for voltage stress relief instructions with applications greater than 2000 V.

A.
System
Overview

B1.
Cable Ties

B2.
Cable
Accessories

B3.
Stainless
Steel Ties

C1.
Wiring
Duct

C2.
Surface
Raceway

C3.
Abrasion
Protection

C4.
Cable
Management

D1.
Terminals

D2.
Power
Connectors

D3.
Grounding
Connectors

E1.
Labeling
Systems

E2.
Labels

E3.
Pre-Printed
& Write-On
Markers

E4.
Permanent
Identification

E5.
Lockout/
Tagout
& Safety
Solutions

F.
Index

A. System Overview



Flex Conductor, One-Hole, Standard Barrel with Window Lug, 90° Angle

For Use with Flexible, Extra-Flexible, and Code Stranded Copper Conductors

Type LCAX-F

- Can be used with code conductor and flex conductor class: G, H, I, K, M and Diesel Locomotive
- Generously beveled wire entry prevents bent back strands when inserting conductor into barrel
- Color-coded barrels marked with *PANDUIT* and specified competitor die index numbers for proper crimp die selection
- Inspection window to visually assure full conductor insertion
- Tin-plated to inhibit corrosion
- UL Listed and CSA Certified to 35 KV** and temperature rated to 90°C when crimped with *PANDUIT* and specified competitor crimping tools and dies
- American Bureau of Shipping approved

B1. Cable Ties

B2. Cable Accessories

B3. Stainless Steel Ties

C1. Wiring Duct

C2. Surface Raceway

C3. Abrasion Protection

C4. Cable Management

D1. Terminals

D2. Power Connectors

D3. Grounding Connectors

E1. Labeling Systems

E2. Labels

E3. Pre-Printed & Write-On Markers

E4. Permanent Identification

E5. Lockout/Tagout & Safety Solutions

F. Index

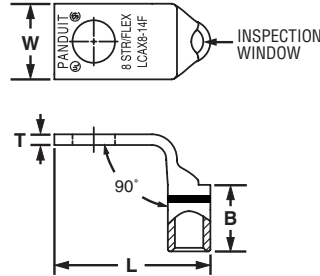

Part Number	Flex Conductor Size		Code Conductor Size	Stud Hole Size (In.)	Figure Dimensions (In.)				PANDUIT Color Code	PANDUIT Die Index No.‡	Burndy Die Index No.‡	T&B Die Index No.‡	Wire Strip Length (In.)	Std. Pkg. Qty.
	Class G, H, I, K, M	Diesel Locomotive			W	B	T	L						
LCAX8-10F-L	#8 AWG	#8 AWG	#8 AWG	#10	.41	.42	.08	.90	Red	P21	49	21	1/2	50
LCAX8-14F-L				1/4	.48	.42	.07	.99	Red	P21	49	21	1/2	50
LCAX8-56F-L				5/16	.56	.42	.05	1.11	Red	P21	49	21	1/2	50
LCAX8-38F-L				3/8	.60	.42	.05	1.21	Red	P21	49	21	1/2	50
LCAX6-10F-L	#6 AWG	#6 AWG	#6 AWG	#10	.45	.48	.09	.99	Blue	P24	7	24	9/16	50
LCAX6-14F-L				1/4	.48	.48	.08	1.03	Blue	P24	7	24	9/16	50
LCAX6-56F-L				5/16	.56	.48	.07	1.15	Blue	P24	7	24	9/16	50
LCAX6-38F-L				3/8	.62	.48	.06	1.25	Blue	P24	7	24	9/16	50
LCAX4-10F-L	#4 AWG	#5, #4, #3 AWG	#4 AWG	#10	.55	.53	.09	1.03	Gray	P29	8	29	5/8	50
LCAX4-14F-L				1/4	.55	.53	.09	1.12	Gray	P29	8	29	5/8	50
LCAX4-56F-L				5/16	.55	.53	.09	1.24	Gray	P29	8	29	5/8	50
LCAX4-38F-L				3/8	.62	.53	.07	1.34	Gray	P29	8	29	5/8	50
LCAX2-10F-E*	#2 AWG	#2 AWG	#2 AWG	#10	.70	.59	.11	1.21	Brown	P33	10	33	11/16	20
LCAX2-14F-E*				1/4	.70	.59	.11	1.31	Brown	P33	10	33	11/16	20
LCAX2-56F-E*				5/16	.70	.59	.11	1.44	Brown	P33	10	33	11/16	20
LCAX2-38F-E*				3/8	.70	.59	.11	1.51	Brown	P33	10	33	11/16	20
LCAX2-12F-E*	1/2	.75	.59	.09	1.75	Brown	P33	10	33	11/16	20			
LCAX1-10F-X	#1 AWG	#1 AWG	#1 AWG	#10	.76	.66	.12	1.28	Green	P37	11	37	3/4	10
LCAX1-14F-X				1/4	.76	.66	.12	1.45	Green	P37	11	37	3/4	10
LCAX1-56F-X				5/16	.76	.66	.12	1.51	Green	P37	11	37	3/4	10
LCAX1-38F-X				3/8	.76	.66	.12	1.58	Green	P37	11	37	3/4	10
LCAX1-12F-X	1/2	.80	.66	.12	1.82	Green	P37	11	37	3/4	10			
LCAX1/0-14F-X	1/0 AWG	1/0 AWG	1/0 AWG	1/4	.85	.72	.13	1.59	Pink	P42	12	42	3/4	10
LCAX1/0-56F-X				5/16	.85	.72	.13	1.59	Pink	P42	12	42	3/4	10
LCAX1/0-38F-X				3/8	.85	.72	.13	1.66	Pink	P42	12	42	3/4	10
LCAX1/0-12F-X				1/2	.85	.72	.13	1.91	Pink	P42	12	42	3/4	10

‡See pages D3.66 – D3.69 for tool and die information.

*Not UL Listed or CSA Certified with Class K flex conductor when crimped with Burndy tools.

**Consult cable manufacturer for voltage stress relief instructions with applications greater than 2000 V.



Flex Conductor, One-Hole, Standard Barrel with Window Lug, 90° Angle (continued)

Part Number	Flex Conductor Size		Code Conductor Size	Stud Hole Size (In.)	Figure Dimensions (In.)				PANDUIT Color Code	PANDUIT Die Index No.‡	Burndy Die Index No.‡	T&B Die Index No.‡	Wire Strip Length (In.)	Std. Pkg. Qty.
	Class G, H, I, K, M	Diesel Locomotive			W	B	T	L						
LCAX2/0-10F-X	2/0 AWG	2/0 AWG	2/0 AWG	#10	.96	.83	.13	1.42	Black	P45	13	45	7/8	10
LCAX2/0-14F-X				1/4	.96	.83	.13	1.67	Black	P45	13	45	7/8	10
LCAX2/0-56F-X				5/16	.96	.83	.13	1.67	Black	P45	13	45	7/8	10
LCAX2/0-38F-X				3/8	.96	.83	.13	1.73	Black	P45	13	45	7/8	10
LCAX2/0-12F-X				1/2	.96	.83	.13	1.98	Black	P45	13	45	7/8	10
LCAX2/0-58F-X				5/8	.96	.83	.13	2.27	Black	P45	13	45	7/8	10
LCAX2/0-34F-X				3/4	.96	.83	.13	2.41	Black	P45	13	45	7/8	10
LCAX3/0-10F-X	3/0 AWG	3/0 AWG	3/0 AWG	#10	1.06	.91	.14	1.51	Orange	P50	14	50	1	10
LCAX3/0-14F-X				1/4	1.06	.91	.14	1.75	Orange	P50	14	50	1	10
LCAX3/0-56F-X				5/16	1.06	.91	.14	1.77	Orange	P50	14	50	1	10
LCAX3/0-38F-X				3/8	1.06	.91	.14	1.84	Orange	P50	14	50	1	10
LCAX3/0-12F-X				1/2	1.06	.91	.14	2.07	Orange	P50	14	50	1	10
LCAX4/0-14F-X	4/0 AWG	4/0 AWG	4/0 AWG	1/4	1.19	1.03	.16	1.84	Purple	P54	15	54	1 1/16	10
LCAX4/0-56F-X				5/16	1.19	1.03	.16	2.07	Purple	P54	15	54	1 1/16	10
LCAX4/0-38F-X				3/8	1.19	1.03	.16	2.07	Purple	P54	15	54	1 1/16	10
LCAX4/0-12F-X				1/2	1.19	1.03	.16	2.18	Purple	P54	15	54	1 1/16	10
LCAX4/0-58F-X				5/8	1.19	1.03	.16	2.39	Purple	P54	15	54	1 1/16	10
LCAX4/0-34F-X				3/4	1.19	1.03	.16	2.58	Purple	P54	15	54	1 1/16	10
LCAX250-14F-X				250 kcmil	262.6 kcmil	—	1/4	1.28	1.03	.17	1.90	Yellow	P62	16
LCAX250-56F-X	5/16	1.28	1.03				.17	2.13	Yellow	P62	16	62	1 1/16	10
LCAX250-38F-X	3/8	1.28	1.03				.17	2.13	Yellow	P62	16	62	1 1/16	10
LCAX250-12F-X	1/2	1.28	1.03				.17	2.24	Yellow	P62	16	62	1 1/16	10
LCAX250-58F-X	5/8	1.28	1.03				.17	2.45	Yellow	P62	16	62	1 1/16	10
LCAX250-34F-X	3/4	1.28	1.03				.17	2.64	Yellow	P62	16	62	1 1/16	10
LCAX300-38F-6	300 kcmil	313.1 kcmil	—				3/8	1.39	1.19	.18	2.37	Red	P71	18
LCAX300-12F-6				1/2	1.39	1.19	.18	2.37	Red	P71	18	71H	1 1/4	6
LCAX300-58F-6				5/8	1.39	1.19	.18	2.58	Red	P71	18	71H	1 1/4	6
LCAX350-56F-6	350 kcmil	373.7 kcmil	—	5/16	1.54	1.29	.22	2.32	Blue	P76	19	76H	1 3/8	6
LCAX350-38F-6				3/8	1.54	1.29	.22	2.32	Blue	P76	19	76H	1 3/8	6
LCAX350-12F-6				1/2	1.54	1.29	.22	2.48	Blue	P76	19	76H	1 3/8	6
LCAX350-58F-6				5/8	1.54	1.29	.22	2.69	Blue	P76	19	76H	1 3/8	6
LCAX450-12F-6	450 kcmil	444.4 kcmil	—	1/2	1.70	1.40	.26	2.95	Brown	P87	20	87H	1 7/16	6
LCAX450-58F-6				5/8	1.70	1.40	.26	3.08	Brown	P87	20	87H	1 7/16	6
LCAX500-56F-6	500 kcmil	535.3 kcmil	—	5/16	1.89	1.48	.26	2.44	Pink	P99	L99	99H	1 9/16	6
LCAX500-38F-6				3/8	1.89	1.48	.26	2.44	Pink	P99	L99	99H	1 9/16	6
LCAX500-12F-6				1/2	1.89	1.48	.26	2.81	Pink	P99	L99	99H	1 9/16	6
LCAX500-58F-6				5/8	1.89	1.48	.26	3.37	Pink	P99	L99	99H	1 9/16	6
LCAX650-56F-6	—	646.4 kcmil	—	5/16	1.95	1.45	.30	2.50	Black	P106	24	106H	1 1/2	6
LCAX650-38F-6				3/8	1.95	1.45	.30	2.50	Black	P106	24	106H	1 1/2	6
LCAX650-12F-6				1/2	1.95	1.45	.30	2.86	Black	P106	24	106H	1 1/2	6
LCAX650-58F-6				5/8	1.95	1.45	.30	3.42	Black	P106	24	106H	1 1/2	6
LCAX750-12F-3	—	777.7 kcmil	—	1/2	2.17	1.66	.32	2.86	Yellow	P115	L115	115H	1 3/4	3
LCAX750-58F-3				5/8	2.17	1.66	.32	3.67	Yellow	P115	L115	115H	1 3/4	3

‡See pages D3.66 – D3.69 for tool and die information.

*Not UL Listed or CSA Certified with Class K flex conductor when crimped with Burndy tools.

**Consult cable manufacturer for voltage stress relief instructions with applications greater than 2000 V.

A.
System
Overview

B1.
Cable Ties

B2.
Cable
Accessories

B3.
Stainless
Steel Ties

C1.
Wiring
Duct

C2.
Surface
Raceway

C3.
Abrasion
Protection

C4.
Cable
Management

D1.
Terminals

D2.
Power
Connectors

D3.
Grounding
Connectors

E1.
Labeling
Systems

E2.
Labels

E3.
Pre-Printed
& Write-On
Markers

E4.
Permanent
Identification

E5.
Lockout/
Tagout
& Safety
Solutions

F.
Index

A. System Overview



Flex Conductor, One-Hole, Standard Barrel with Window, Narrow Tongue Lug

For Use with Flexible, Extra-Flexible, and Code Stranded Copper Conductors

B1. Cable Ties

Type LCAXN

- Narrow tongue width for limited space applications
- Can be used with flex conductor class: G, H, I, K, M and Diesel Locomotive
- Generously beveled wire entry prevents bent back strands when inserting conductor into barrel
- Color-coded barrels marked with *PANDUIT* and specified competitor die index numbers for proper crimp die selection
- Inspection window to visually assure full conductor insertion
- Tin-plated to inhibit corrosion
- UL Listed and CSA Certified to 35 KV** and temperature rated to 90°C when crimped with *PANDUIT* and specified competitor crimping tools and dies

B2. Cable Accessories

B3. Stainless Steel Ties

C1. Wiring Duct

C2. Surface Raceway

C3. Abrasion Protection

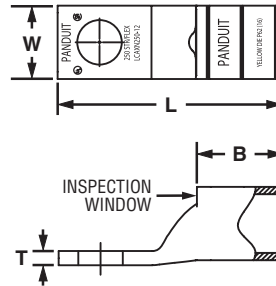

C4. Cable Management

Part Number	Flex Conductor Size		Stud Hole Size (In.)	Figure Dimensions (In.)				PANDUIT Color Code	PANDUIT Die Index No.‡	Burndy Die Index No.‡	T&B Die Index No.‡	Wire Strip Length (In.)	Std. Pkg. Qty.
	Class G, H, I, K, M	Diesel Locomotive		W	B	T	L						
LCAXN250-12-X	250 kcmil	262.6 kcmil	1/2	.88	1.03	.17	2.68	Yellow	P62	16	62	1 1/16	10

‡See pages D3.66 – D3.69 for tool and die information.

**Consult cable manufacturer for voltage stress relief instructions with applications greater than 2000 V.

D1. Terminals

D2. Power Connectors



Flex Conductor, One-Hole, Standard Barrel with Window, Narrow Tongue Lug, 45°

For Use with Flexible, Extra-Flexible, and Code Stranded Copper Conductors

D3. Grounding Connectors

Type LCAXN-H

- Narrow tongue width for limited space applications
- Can be used with flex conductor class: G, H, I, K, M and Diesel Locomotive
- Generously beveled wire entry prevents bent back strands when inserting conductor into barrel
- Color-coded barrels marked with *PANDUIT* and specified competitor die index numbers for proper crimp die selection
- Inspection window to visually assure full conductor insertion
- Tin-plated to inhibit corrosion
- UL Listed and CSA Certified to 35 KV** and temperature rated to 90°C when crimped with *PANDUIT* and specified competitor crimping tools and dies

E1. Labeling Systems

E2. Labels

E3. Pre-Printed & Write-On Markers

E4. Permanent Identification

E5. Lockout/Tagout & Safety Solutions

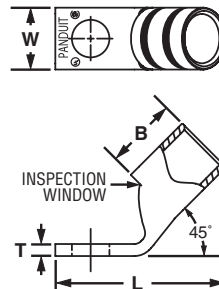

Part Number	Flex Conductor Size		Stud Hole Size (In.)	Figure Dimensions (In.)				PANDUIT Color Code	PANDUIT Die Index No.‡	Burndy Die Index No.‡	T&B Die Index No.‡	Wire Strip Length (In.)	Std. Pkg. Qty.
	Class G, H, I, K, M	Diesel Locomotive		W	B	T	L						
LCAXN250-12H-X	250 kcmil	262.6 kcmil	1/2	.88	1.03	.17	2.41	Yellow	P62	16	62	1 1/16	10

‡See pages D3.66 – D3.69 for tool and die information.

**Consult cable manufacturer for voltage stress relief instructions with applications greater than 2000 V.

F. Index



Flex Conductor, One-Hole, Standard Barrel with Window, Narrow Tongue Lug, 90°

For Use with Flexible, Extra-Flexible, and Code Stranded Copper Conductors

Type LCAXN-F

- Narrow tongue width for limited space applications
- Can be used with flex conductor class: G, H, I, K, M and Diesel Locomotive
- Generously beveled wire entry prevents bent back strands when inserting conductor into barrel
- Color-coded barrels marked with *PANDUIT* and specified competitor die index numbers for proper crimp die selection
- Inspection window to visually assure full conductor insertion
- Tin-plated to inhibit corrosion
- UL Listed and CSA Certified to 35 KV** and temperature rated to 90°C when crimped with *PANDUIT* and specified competitor crimping tools and dies

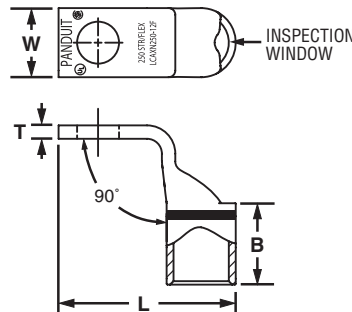

Part Number	Flex Conductor Size		Stud Hole Size (In.)	Figure Dimensions (In.)				PANDUIT Color Code	PANDUIT Die Index No.‡	Burdny Die Index No.‡	T&B Die Index No.‡	Wire Strip Length (In.)	Std. Pkg. Qty.
	Class G, H, I, K, M	Diesel Locomotive		W	B	T	L						
LCAXN250-12F-X	250 kcmil	262.6 kcmil	1/2	.88	1.03	.17	2.24	Yellow	P62	16	62	1 1/16	10

‡See pages D3.66 – D3.69 for tool and die information.

**Consult cable manufacturer for voltage stress relief instructions with applications greater than 2000 V.

A. System Overview

B1. Cable Ties

B2. Cable Accessories

B3. Stainless Steel Ties

C1. Wiring Duct

C2. Surface Raceway

C3. Abrasion Protection

C4. Cable Management

D1. Terminals

D2. Power Connectors

D3. Grounding Connectors

E1. Labeling Systems

E2. Labels

E3. Pre-Printed & Write-On Markers

E4. Permanent Identification

E5. Lockout/Tagout & Safety Solutions

F. Index

A. System Overview



Flex Conductor, One-Hole, Standard Barrel with Window, Flared NEBS Lug

B1. Cable Ties

For Use with Flexible and Extra-Flexible Copper Conductors

Type LCAF

- Can be used with flex conductor class: K, M, and Diesel Locomotive
- Flared entry prevents bent back strands when inserting fine strand conductor into barrel
- Color-coded barrels marked with *PANDUIT* die index numbers for proper crimp die selection
- Inspection window to visually assure full conductor insertion

- Tin-plated to inhibit corrosion
- UL Listed and CSA Certified to 35 KV** and temperature rated to 90°C when crimped with *PANDUIT* crimping tools and dies
- **Tested by Telcordia – meets NEBS Level 3**
- American Bureau of Shipping approved

B2. Cable Accessories

B3. Stainless Steel Ties

C1. Wiring Duct

C2. Surface Raceway

C3. Abrasion Protection

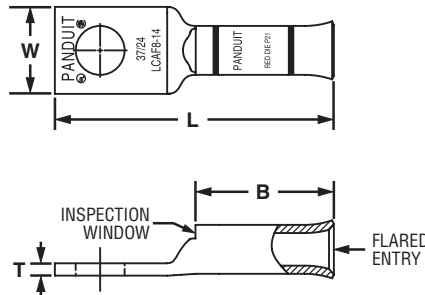

C4. Cable Management

Part Number	Flex Conductor Size		Stud Hole Size (In.)	Figure Dimensions (In.)				PANDUIT Color Code	PANDUIT Die Index No.‡	Wire Strip Length (In.)	Std. Pkg. Qty.
	Class K and M	Diesel Locomotive		W	B	T	L				
LCAF8-10-L	—	#8 AWG	#10	.41	.76	.08	1.45	Red	P21	13/16	50
LCAF8-14-L			1/4	.48	.76	.07	1.54	Red	P21	13/16	50
LCAF8-56-L			5/16	.56	.76	.05	1.66	Red	P21	13/16	50
LCAF8-38-L			3/8	.60	.76	.05	1.76	Red	P21	13/16	50
LCAF6-10-L	#6 AWG	#6 AWG	#10	.45	.81	.09	1.52	Blue	P24	7/8	50
LCAF6-14-L			1/4	.48	.81	.08	1.61	Blue	P24	7/8	50
LCAF6-56-L			5/16	.56	.81	.07	1.73	Blue	P24	7/8	50
LCAF6-38-L			3/8	.62	.81	.06	1.83	Blue	P24	7/8	50
LCAF4-10-L	#4 AWG	#4 AWG	#10	.55	.81	.09	1.54	Gray	P29	7/8	50
LCAF4-14-L			1/4	.55	.81	.09	1.63	Gray	P29	7/8	50
LCAF4-56-L			5/16	.55	.81	.09	1.75	Gray	P29	7/8	50
LCAF4-38-L			3/8	.62	.81	.07	1.85	Gray	P29	7/8	50
LCAF2-14-E	#2 AWG	#2 AWG	1/4	.70	.88	.11	1.79	Brown	P33	15/16	20
LCAF2-56-E			5/16	.70	.88	.11	1.92	Brown	P33	15/16	20
LCAF2-38-E			3/8	.70	.88	.11	1.99	Brown	P33	15/16	20
LCAF2-12-E			1/2	.79	.88	.09	2.23	Brown	P33	15/16	20
LCAF1-14-X	#1 AWG	#1 AWG	1/4	.76	.94	.12	1.95	Pink	P42	1	10
LCAF1-56-X			5/16	.76	.94	.12	2.00	Pink	P42	1	10
LCAF1-38-X			3/8	.76	.94	.12	2.08	Pink	P42	1	10
LCAF1-12-X			1/2	.80	.94	.12	2.31	Pink	P42	1	10
LCAF1/0-14-X	1/0 AWG	1/0 AWG	1/4	.85	1.35	.13	2.46	Black	P45	1 7/16	10
LCAF1/0-56-X			5/16	.85	1.35	.13	2.46	Black	P45	1 7/16	10
LCAF1/0-38-X			3/8	.85	1.35	.13	2.52	Black	P45	1 7/16	10
LCAF1/0-12-X			1/2	.85	1.35	.13	2.77	Black	P45	1 7/16	10
LCAF2/0-14-X	2/0 AWG	2/0 AWG	1/4	.96	1.35	.13	2.49	Orange	P50	1 7/16	10
LCAF2/0-56-X			5/16	.96	1.35	.13	2.49	Orange	P50	1 7/16	10
LCAF2/0-38-X			3/8	.96	1.35	.13	2.55	Orange	P50	1 7/16	10
LCAF2/0-12-X			1/2	.96	1.35	.13	2.80	Orange	P50	1 7/16	10

‡See pages D3.70, D3.71 for tool and die information.

**Consult cable manufacturer for voltage stress relief instructions with applications greater than 2000 V.

E5. Lockout/Tagout & Safety Solutions

F. Index



Flex Conductor, One-Hole, Standard Barrel with Window, Flared NEBS Lug (continued)

Part Number	Flex Conductor Size		Stud Hole Size (In.)	Figure Dimensions (In.)				PANDUIT Color Code	PANDUIT Die Index No.‡	Wire Strip Length (In.)	Std. Pkg. Qty.
	Class K and M	Diesel Locomotive		W	B	T	L				
LCAF3/0-14-X	3/0 AWG	3/0 AWG	1/4	1.06	1.35	.14	2.52	Purple	P54	1 7/16	10
LCAF3/0-56-X			5/16	1.06	1.35	.14	2.53	Purple	P54	1 7/16	10
LCAF3/0-38-X			3/8	1.06	1.35	.14	2.60	Purple	P54	1 7/16	10
LCAF3/0-12-X			1/2	1.06	1.35	.14	2.83	Purple	P54	1 7/16	10
LCAF4/0-14-X	4/0 AWG	4/0 AWG	1/4	1.17	1.35	.14	2.56	Yellow	P62	1 7/16	10
LCAF4/0-56-X			5/16	1.17	1.35	.14	2.58	Yellow	P62	1 7/16	10
LCAF4/0-38-X			3/8	1.17	1.35	.14	2.65	Yellow	P62	1 7/16	10
LCAF4/0-12-X			1/2	1.17	1.35	.14	2.88	Yellow	P62	1 7/16	10
LCAF250-38-X	250 kcmil	262.6 kcmil	3/8	1.28	1.65	.17	3.19	White	P66	1 3/4	10
LCAF250-12-X			1/2	1.28	1.65	.17	3.30	White	P66	1 3/4	10
LCAF250-58-X			5/8	1.28	1.65	.17	3.51	White	P66	1 3/4	10
LCAF250-78-X			7/8	1.28	1.65	.17	3.95	White	P66	1 3/4	10
LCAF300-38-6	300 kcmil	313.1 kcmil	3/8	1.39	1.65	.18	3.37	Red	P71	1 3/4	6
LCAF300-12-6			1/2	1.39	1.65	.18	3.37	Red	P71	1 3/4	6
LCAF300-58-6			5/8	1.39	1.65	.18	3.58	Red	P71	1 3/4	6
LCAF300-78-6			7/8	1.39	1.65	.18	3.97	Red	P71	1 3/4	6
LCAF350-38-6	350 kcmil	373.7 kcmil	3/8	1.54	1.85	.22	3.49	Blue	P76	1 15/16	6
LCAF350-12-6			1/2	1.54	1.85	.22	3.65	Blue	P76	1 15/16	6
LCAF350-58-6			5/8	1.54	1.85	.22	3.86	Blue	P76	1 15/16	6
LCAF350-34-6			3/4	1.54	1.85	.22	4.00	Blue	P76	1 15/16	6
LCAF350-78-6			7/8	1.54	1.85	.22	4.25	Blue	P76	1 15/16	6
LCAF350-1-6			1	1.54	1.85	.22	4.37	Blue	P76	1 15/16	6
LCAF400-12-6	400 kcmil	444.4 kcmil	1/2	1.70	2.20	.26	4.65	Brown	P87	2 1/4	6
LCAF400-58-6			5/8	1.70	2.20	.26	4.65	Brown	P87	2 1/4	6
LCAF400-78-6			7/8	1.70	2.20	.26	4.65	Brown	P87	2 1/4	6
LCAF500-12-6	500 kcmil	535.3 kcmil	1/2	1.89	2.28	.26	4.99	Pink	P99	2 5/16	6
LCAF500-58-6			5/8	1.89	2.28	.26	5.18	Pink	P99	2 5/16	6
LCAF600-12-6	—	646.4 kcmil	1/2	1.95	2.33	.30	5.07	Black	P106	2 3/8	6
LCAF600-58-6			5/8	1.95	2.33	.30	5.26	Black	P106	2 3/8	6
LCAF750-12-3	—	777.7 kcmil	1/2	2.17	2.38	.32	5.21	Orange	P107	2 7/16	3
LCAF750-58-3			5/8	2.17	2.38	.32	5.40	Orange	P107	2 7/16	3

‡See pages D3.70, D3.71 for tool and die information.

**Consult cable manufacturer for voltage stress relief instructions with applications greater than 2000 V.

A.
System
Overview

B1.
Cable Ties

B2.
Cable
Accessories

B3.
Stainless
Steel Ties

C1.
Wiring
Duct

C2.
Surface
Raceway

C3.
Abrasion
Protection

C4.
Cable
Management

D1.
Terminals

D2.
Power
Connectors

D3.
Grounding
Connectors

E1.
Labeling
Systems

E2.
Labels

E3.
Pre-Printed
& Write-On
Markers

E4.
Permanent
Identification

E5.
Lockout/
Tagout
& Safety
Solutions

F.
Index

A. System Overview



Flex Conductor, One-Hole, Standard Barrel with Window, Flared NEBS Lug, 45° Angle

B1. Cable Ties

For Use with Flexible and Extra-Flexible Copper Conductors

Type LCAF-H

- Can be used with flex conductor class: K, M, and Diesel Locomotive
- Flared entry prevents bent back strands when inserting fine strand conductor into barrel
- Color-coded barrels marked with *PANDUIT* die index numbers for proper crimp die selection
- Inspection window to visually assure full conductor insertion
- Tin-plated to inhibit corrosion
- UL Listed and CSA Certified to 35 KV** and temperature rated to 90°C when crimped with *PANDUIT* crimping tools and dies
- **Tested by Telcordia – meets NEBS Level 3**
- American Bureau of Shipping approved

B2. Cable Accessories

B3. Stainless Steel Ties

C1. Wiring Duct

C2. Surface Raceway

C3. Abrasion Protection

C4. Cable Management

D1. Terminals

D2. Power Connectors

D3. Grounding Connectors

E1. Labeling Systems

E2. Labels

E3. Pre-Printed & Write-On Markers

E4. Permanent Identification

E5. Lockout/Tagout & Safety Solutions

F. Index

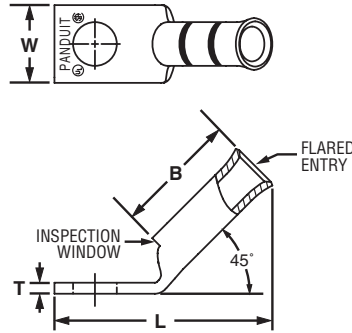

Part Number	Flex Conductor Size		Stud Hole Size (In.)	Figure Dimensions (In.)				PANDUIT Color Code	PANDUIT Die Index No.‡	Wire Strip Length (In.)	Std. Pkg. Qty.
	Class K and M	Diesel Locomotive		W	B	T	L				
LCAF8-10H-L	—	#8 AWG	#10	.41	.76	.08	1.26	Red	P21	13/16	50
LCAF8-14H-L			1/4	.48	.76	.07	1.35	Red	P21	13/16	50
LCAF8-56H-L			5/16	.56	.76	.05	1.46	Red	P21	13/16	50
LCAF8-38H-L	#6 AWG	#6 AWG	3/8	.60	.76	.05	1.55	Red	P21	13/16	50
LCAF6-10H-L			#10	.45	.81	.09	1.31	Blue	P24	7/8	50
LCAF6-14H-L			1/4	.48	.81	.08	1.40	Blue	P24	7/8	50
LCAF6-56H-L	#4 AWG	#4 AWG	5/16	.56	.81	.07	1.51	Blue	P24	7/8	50
LCAF6-38H-L			3/8	.62	.81	.06	1.61	Blue	P24	7/8	50
LCAF4-10H-L			#10	.55	.81	.09	1.34	Gray	P29	7/8	50
LCAF4-14H-L	#2 AWG	#2 AWG	1/4	.55	.81	.09	1.43	Gray	P29	7/8	50
LCAF4-56H-L			5/16	.55	.81	.09	1.55	Gray	P29	7/8	50
LCAF4-38H-L			3/8	.62	.81	.07	1.64	Gray	P29	7/8	50
LCAF2-14H-E	#1 AWG	#1 AWG	1/4	.70	.88	.11	1.52	Brown	P33	15/16	20
LCAF2-56H-E			5/16	.70	.88	.11	1.65	Brown	P33	15/16	20
LCAF2-38H-E			3/8	.70	.88	.11	1.72	Brown	P33	15/16	20
LCAF2-12H-E	#1/0 AWG	#1/0 AWG	1/2	.79	.88	.09	1.95	Brown	P33	15/16	20
LCAF1-14H-X			1/4	.76	.94	.12	1.65	Pink	P42	1	10
LCAF1-56H-X			5/16	.76	.94	.12	1.71	Pink	P42	1	10
LCAF1-38H-X	2/0 AWG	2/0 AWG	3/8	.76	.94	.12	1.78	Pink	P42	1	10
LCAF1-12H-X			1/2	.80	.94	.12	2.01	Pink	P42	1	10
LCAF1/0-14H-X			1/4	.85	1.35	.13	2.06	Black	P45	1 7/16	10
LCAF1/0-56H-X	2/0 AWG	2/0 AWG	5/16	.85	1.35	.13	2.06	Black	P45	1 7/16	10
LCAF1/0-38H-X			3/8	.85	1.35	.13	2.12	Black	P45	1 7/16	10
LCAF1/0-12H-X			1/2	.85	1.35	.13	2.37	Black	P45	1 7/16	10
LCAF2/0-14H-X	2/0 AWG	2/0 AWG	1/4	.96	1.35	.13	2.08	Orange	P50	1 7/16	10
LCAF2/0-56H-X			5/16	.96	1.35	.13	2.08	Orange	P50	1 7/16	10
LCAF2/0-38H-X			3/8	.96	1.35	.13	2.14	Orange	P50	1 7/16	10
LCAF2/0-12H-X			1/2	.96	1.35	.13	2.39	Orange	P50	1 7/16	10

‡See pages D3.70, D3.71 for tool and die information.

**Consult cable manufacturer for voltage stress relief instructions with applications greater than 2000 V.



Flex Conductor, One-Hole, Standard Barrel with Window, Flared NEBS Lug, 45° Angle (continued)

Part Number	Flex Conductor Size		Stud Hole Size (In.)	Figure Dimensions (In.)				PANDUIT Color Code	PANDUIT Die Index No.‡	Wire Strip Length (In.)	Std. Pkg. Qty.
	Class K and M	Diesel Locomotive		W	B	T	L				
LCAF3/0-14H-X	3/0 AWG	3/0 AWG	1/4	1.06	1.35	.14	2.11	Purple	P54	1 7/16	10
LCAF3/0-56H-X			5/16	1.06	1.35	.14	2.13	Purple	P54	1 7/16	10
LCAF3/0-38H-X			3/8	1.06	1.35	.14	2.20	Purple	P54	1 7/16	10
LCAF3/0-12H-X			1/2	1.06	1.35	.14	2.43	Purple	P54	1 7/16	10
LCAF4/0-14H-X	4/0 AWG	4/0 AWG	1/4	1.17	1.35	.14	2.16	Yellow	P62	1 7/16	10
LCAF4/0-56H-X			5/16	1.17	1.35	.14	2.17	Yellow	P62	1 7/16	10
LCAF4/0-38H-X			3/8	1.17	1.35	.14	2.24	Yellow	P62	1 7/16	10
LCAF4/0-12H-X			1/2	1.17	1.35	.14	2.47	Yellow	P62	1 7/16	10
LCAF250-38H-X	250 kcmil	262.6 kcmil	3/8	1.28	1.65	.17	3.19	White	P66	1 3/4	10
LCAF250-12H-X			1/2	1.28	1.65	.17	2.89	White	P66	1 3/4	10
LCAF250-58H-X			5/8	1.28	1.65	.17	3.10	White	P66	1 3/4	10
LCAF250-78H-X			7/8	1.28	1.65	.17	3.54	White	P66	1 3/4	10
LCAF300-38H-6	300 kcmil	313.1 kcmil	3/8	1.39	1.64	.18	3.00	Red	P71	1 3/4	6
LCAF300-12H-6			1/2	1.39	1.64	.18	3.00	Red	P71	1 3/4	6
LCAF300-58H-6			5/8	1.39	1.64	.18	3.21	Red	P71	1 3/4	6
LCAF300-78H-6			7/8	1.39	1.64	.18	3.60	Red	P71	1 3/4	6
LCAF350-38H-6	350 kcmil	373.7 kcmil	3/8	1.54	1.84	.22	3.06	Blue	P76	1 15/16	6
LCAF350-12H-6			1/2	1.54	1.84	.22	3.22	Blue	P76	1 15/16	6
LCAF350-58H-6			5/8	1.54	1.84	.22	3.43	Blue	P76	1 15/16	6
LCAF350-34H-6			3/4	1.54	1.84	.22	3.57	Blue	P76	1 15/16	6
LCAF350-78H-6			7/8	1.54	1.84	.22	3.82	Blue	P76	1 15/16	6
LCAF350-1H-6			1	1.54	1.84	.22	3.94	Blue	P76	1 15/16	6
LCAF400-12H-6	400 kcmil	444.4 kcmil	1/2	1.70	2.19	.26	4.12	Brown	P87	2 1/4	6
LCAF400-58H-6			5/8	1.70	2.19	.26	4.12	Brown	P87	2 1/4	6
LCAF400-78H-6			7/8	1.70	2.19	.26	4.12	Brown	P87	2 1/4	6

‡See pages D3.70, D3.71 for tool and die information.

**Consult cable manufacturer for voltage stress relief instructions with applications greater than 2000 V.

A. System Overview

B1. Cable Ties

B2. Cable Accessories

B3. Stainless Steel Ties

C1. Wiring Duct

C2. Surface Raceway

C3. Abrasion Protection

C4. Cable Management

D1. Terminals

D2. Power Connectors

D3. Grounding Connectors

E1. Labeling Systems

E2. Labels

E3. Pre-Printed & Write-On Markers

E4. Permanent Identification

E5. Lockout/Tagout & Safety Solutions

F. Index

A. System Overview



Flex Conductor, One-Hole, Standard Barrel with Window, Flared NEBS Lug, 90° Angle

B1. Cable Ties

For Use with Flexible and Extra-Flexible Copper Conductors

Type LCAF-F

- Can be used with flex conductor class: K, M, and Diesel Locomotive
- Flared entry prevents bent back strands when inserting fine strand conductor into barrel
- Color-coded barrels marked with *PANDUIT* die index numbers for proper crimp die selection
- Inspection window to visually assure full conductor insertion
- Tin-plated to inhibit corrosion
- UL Listed and CSA Certified to 35 KV** and temperature rated to 90°C when crimped with *PANDUIT* crimping tools and dies
- **Tested by Telcordia – meets NEBS Level 3**
- American Bureau of Shipping Approved

C1. Wiring Duct

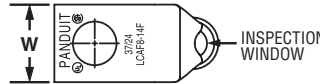

C2. Surface Raceway

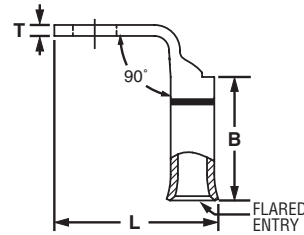

C3. Abrasion Protection

C4. Cable Management

D1. Terminals

D2. Power Connectors

D3. Grounding Connectors

E1. Labeling Systems

E2. Labels

E3. Pre-Printed & Write-On Markers

E4. Permanent Identification

E5. Lockout/Tagout & Safety Solutions

F. Index

Part Number	Flex Conductor Size		Stud Hole Size (In.)	Figure Dimensions (In.)				PANDUIT Color Code	PANDUIT Die Index No.‡	Wire Strip Length (In.)	Std. Pkg. Qty.
	Class K and M	Diesel Locomotive		W	B	T	L				
LCAF8-10F-L	—	#8 AWG	#10	.41	.76	.08	.93	Red	P21	13/16	50
LCAF8-14F-L			1/4	.48	.76	.07	1.02	Red	P21	13/16	50
LCAF8-56F-L			5/16	.56	.76	.05	1.14	Red	P21	13/16	50
LCAF8-38F-L	#6 AWG	#6 AWG	3/8	.60	.76	.05	1.24	Red	P21	13/16	50
LCAF6-10F-L			#10	.45	.81	.09	1.52	Blue	P24	7/8	50
LCAF6-14F-L			1/4	.48	.81	.08	1.06	Blue	P24	7/8	50
LCAF6-56F-L	#4 AWG	#4 AWG	5/16	.56	.81	.07	1.18	Blue	P24	7/8	50
LCAF6-38F-L			3/8	.62	.81	.06	1.28	Blue	P24	7/8	50
LCAF4-10F-L			#10	.55	.81	.09	1.07	Gray	P29	7/8	50
LCAF4-14F-L	#1 AWG	#1 AWG	1/4	.55	.81	.09	1.16	Gray	P29	7/8	50
LCAF4-56F-L			5/16	.55	.81	.09	1.28	Gray	P29	7/8	50
LCAF4-38F-L			3/8	.62	.81	.07	1.38	Gray	P29	7/8	50
LCAF2-14F-E	#2 AWG	#2 AWG	1/4	.70	.88	.11	1.35	Brown	P33	15/16	20
LCAF2-56F-E			5/16	.70	.88	.11	1.48	Brown	P33	15/16	20
LCAF2-38F-E			3/8	.70	.88	.11	1.55	Brown	P33	15/16	20
LCAF2-12F-E	#1 AWG	#1 AWG	1/2	.79	.88	.09	1.79	Brown	P33	15/16	20
LCAF1-14F-X			1/4	.76	.94	.12	1.49	Pink	P42	1	10
LCAF1-56F-X			5/16	.76	.94	.12	1.54	Pink	P42	1	10
LCAF1-38F-X	1/0 AWG	1/0 AWG	3/8	.76	.94	.12	1.62	Pink	P42	1	10
LCAF1-12F-X			1/2	.80	.94	.12	1.85	Pink	P42	1	10
LCAF1/0-14F-X			1/4	.85	1.35	.13	1.64	Black	P45	1 7/16	10
LCAF1/0-56F-X	2/0 AWG	2/0 AWG	5/16	.85	1.35	.13	1.70	Black	P45	1 7/16	10
LCAF1/0-38F-X			3/8	.85	1.35	.13	1.70	Black	P45	1 7/16	10
LCAF1/0-12F-X			1/2	.85	1.35	.13	1.95	Black	P45	1 7/16	10
LCAF2/0-14F-X	2/0 AWG	2/0 AWG	1/4	.96	1.35	.13	1.71	Orange	P50	1 7/16	10
LCAF2/0-56F-X			5/16	.96	1.35	.13	1.71	Orange	P50	1 7/16	10
LCAF2/0-38F-X			3/8	.96	1.35	.13	1.77	Orange	P50	1 7/16	10
LCAF2/0-12F-X			1/2	.96	1.35	.13	2.02	Orange	P50	1 7/16	10

‡See pages D3.70, D3.71 for tool and die information.

**Consult cable manufacturer for voltage stress relief instructions with applications greater than 2000 V.



Flex Conductor, One-Hole, Standard Barrel with Window, Flared NEBS Lug, 90° Angle (continued)

Part Number	Flex Conductor Size		Stud Hole Size (In.)	Figure Dimensions (In.)				PANDUIT Color Code	PANDUIT Die Index No.‡	Wire Strip Length (In.)	Std. Pkg. Qty.
	Class K and M	Diesel Locomotive		W	B	T	L				
LCAF3/0-14F-X	3/0 AWG	3/0 AWG	1/4	1.06	1.35	.14	1.81	Purple	P54	1 7/16	10
LCAF3/0-56F-X			5/16	1.06	1.35	.14	1.82	Purple	P54	1 7/16	10
LCAF3/0-38F-X			3/8	1.06	1.35	.14	1.89	Purple	P54	1 7/16	10
LCAF3/0-12F-X			1/2	1.06	1.35	.14	2.12	Purple	P54	1 7/16	10
LCAF4/0-14F-X	4/0 AWG	4/0 AWG	1/4	1.17	1.35	.14	1.88	Yellow	P62	1 7/16	10
LCAF4/0-56F-X			5/16	1.17	1.35	.14	1.90	Yellow	P62	1 7/16	10
LCAF4/0-38F-X			3/8	1.17	1.35	.14	1.97	Yellow	P62	1 7/16	10
LCAF4/0-12F-X			1/2	1.17	1.35	.14	2.20	Yellow	P62	1 7/16	10
LCAF250-38F-X	250 kcmil	262.6 kcmil	3/8	1.28	1.65	.17	2.21	White	P66	1 3/4	10
LCAF250-12F-X			1/2	1.28	1.65	.17	2.32	White	P66	1 3/4	10
LCAF250-58F-X			5/8	1.28	1.65	.17	2.53	White	P66	1 3/4	10
LCAF250-78F-X			7/8	1.28	1.65	.17	2.97	White	P66	1 3/4	10
LCAF300-38F-6	300 kcmil	313.1 kcmil	3/8	1.39	1.65	.18	2.44	Red	P71	1 3/4	6
LCAF300-12F-6			1/2	1.39	1.65	.18	2.44	Red	P71	1 3/4	6
LCAF300-58F-6			5/8	1.39	1.65	.18	2.65	Red	P71	1 3/4	6
LCAF300-78F-6			7/8	1.39	1.65	.18	3.04	Red	P71	1 3/4	6
LCAF350-38F-6	350 kcmil	373.7 kcmil	3/8	1.54	1.85	.22	2.40	Blue	P76	1 15/16	6
LCAF350-12F-6			1/2	1.54	1.85	.22	2.40	Blue	P76	1 15/16	6
LCAF350-58F-6			5/8	1.54	1.85	.22	2.77	Blue	P76	1 15/16	6
LCAF350-34F-6			3/4	1.54	1.85	.22	2.91	Blue	P76	1 15/16	6
LCAF350-78F-6			7/8	1.54	1.85	.22	3.16	Blue	P76	1 15/16	6
LCAF350-1F-6			1	1.54	1.85	.22	3.28	Blue	P76	1 15/16	6
LCAF400-12F-6	400 kcmil	444.4 kcmil	1/2	1.70	2.20	.26	3.28	Brown	P87	2 1/4	6
LCAF400-58F-6			5/8	1.70	2.20	.26	3.28	Brown	P87	2 1/4	6
LCAF400-78F-6			7/8	1.70	2.20	.26	3.28	Brown	P87	2 1/4	6

‡See pages D3.70, D3.71 for tool and die information.

**Consult cable manufacturer for voltage stress relief instructions with applications greater than 2000 V.

A.
System Overview

B1.
Cable Ties

B2.
Cable Accessories

B3.
Stainless Steel Ties

C1.
Wiring Duct

C2.
Surface Raceway

C3.
Abrasion Protection

C4.
Cable Management

D1.
Terminals

D2.
Power Connectors

D3.
Grounding Connectors

E1.
Labeling Systems

E2.
Labels

E3.
Pre-Printed & Write-On Markers

E4.
Permanent Identification

E5.
Lockout/Tagout & Safety Solutions

F.
Index

A. System Overview



Flex Conductor, One-Hole, Long Barrel with Window Lug

For Use with Flexible, Extra-Flexible, and Code Stranded Copper Conductors

Type LCBX

- Can be used with code conductor and flex conductor class: G, H, I, K, M and Diesel Locomotive
- Long barrel maximizes number of crimps and provides premium wire pull-out strength and electrical performance
- Generously beveled wire entry prevents bent back strands when inserting conductor into barrel
- Color-coded barrels marked with *PANDUIT* and specified competitor die index numbers for proper crimp die selection
- Inspection window to visually assure full conductor insertion
- Tin-plated to inhibit corrosion
- UL Listed and CSA Certified to 35 KV** and temperature rated to 90°C when crimped with *PANDUIT* and specified competitor crimping tools and dies
- Meets J-STD-607-A and TIA-942 requirements for network systems grounding applications

B1. Cable Ties

B2. Cable Accessories

B3. Stainless Steel Ties

C1. Wiring Duct

C2. Surface Raceway

C3. Abrasion Protection

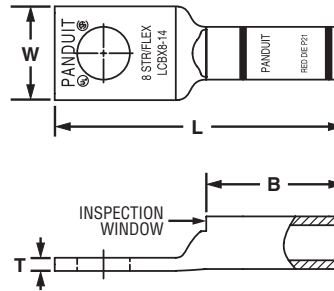

C4. Cable Management

Part Number	Flex Conductor Size		Code Conductor Size	Stud Hole Size (In.)	Figure Dimensions (In.)				PANDUIT Color Code	PANDUIT Die Index No.‡	Burndy Die Index No.‡	T&B Die Index No.‡	Wire Strip Length (In.)	Std. Pkg. Qty.
	Class G, H, I, K, M	Diesel Locomotive			W	B	T	L						
LCBX8-10-L				#10	.41	.70	.08	1.39	Red	P21	49	21	3/4	50
LCBX8-14-L	#8 AWG	#8 AWG	#8 AWG	1/4	.48	.70	.07	1.48	Red	P21	49	21	3/4	50
LCBX8-38-L				3/8	.60	.70	.05	1.70	Red	P21	49	21	3/4	50
LCBX6-14-L	#6 AWG	#6 AWG	#6 AWG	1/4	.48	1.07	.08	1.86	Blue	P24	7	24	1 1/8	50
LCBX6-38-L				3/8	.62	1.07	.06	2.08	Blue	P24	7	24	1 1/8	50
LCBX4-14-L	#4 AWG	#5, #4, #3 AWG	#4 AWG	1/4	.55	1.05	.09	1.87	Gray	P29	8	29	1 1/8	50
LCBX4-38-L				3/8	.62	1.05	.07	2.09	Gray	P29	8	29	1 1/8	50
LCBX2-14-E*				1/4	.70	1.36	.11	2.26	Brown	P33	10	33	1 7/16	20
LCBX2-38-E*	#2 AWG	#2 AWG	#2 AWG	3/8	.70	1.36	.11	2.46	Brown	P33	10	33	1 7/16	20
LCBX2-12-E*				1/2	.75	1.36	.09	2.70	Brown	P33	10	33	1 7/16	20
LCBX1-14-X				1/4	.76	1.44	.12	2.44	Green	P37	11	37	1 1/2	10
LCBX1-56-X	#1 AWG	#1 AWG	#1 AWG	5/16	.76	1.44	.12	2.50	Green	P37	11	37	1 1/2	10
LCBX1-38-X				3/8	.76	1.44	.12	2.57	Green	P37	11	37	1 1/2	10
LCBX1/0-14-X				1/4	.85	1.50	.13	2.61	Pink	P42	12	42	1 9/16	10
LCBX1/0-38-X	1/0 AWG	1/0 AWG	1/0 AWG	3/8	.85	1.50	.13	2.67	Pink	P42	12	42	1 9/16	10
LCBX1/0-12-X				1/2	.85	1.50	.13	2.92	Pink	P42	12	42	1 9/16	10
LCBX2/0-14-X				1/4	.96	1.50	.13	2.64	Black	P45	13	45	1 9/16	10
LCBX2/0-38-X	2/0 AWG	2/0 AWG	2/0 AWG	3/8	.96	1.50	.13	2.70	Black	P45	13	45	1 9/16	10
LCBX2/0-12-X				1/2	.96	1.50	.13	2.96	Black	P45	13	45	1 9/16	10
LCBX3/0-38-X	3/0 AWG	3/0 AWG	3/0 AWG	3/8	1.06	1.56	.14	2.81	Orange	P50	14	50	1 5/8	10
LCBX4/0-38-X				3/8	1.19	2.24	.16	3.74	Purple	P54	15	54	2 5/16	10
LCBX4/0-12-X	4/0 AWG	4/0 AWG	4/0 AWG	1/2	1.19	2.24	.16	3.85	Purple	P54	15	54	2 5/16	10
LCBX250-38-X	250 kcmil	262.6 kcmil	—	3/8	1.28	2.24	.17	3.78	Yellow	P62	16	62	2 5/16	10
LCBX300-38-6	300 kcmil	313.1 kcmil	—	3/8	1.39	2.30	.18	4.02	Red	P71	18	71H	2 3/8	6
LCBX350-38-6				3/8	1.54	2.50	.22	4.14	Blue	P76	19	76H	2 9/16	6
LCBX350-12-6	350 kcmil	373.7 kcmil	—	1/2	1.54	2.50	.22	4.30	Blue	P76	19	76H	2 9/16	6
LCBX450-38-6	450 kcmil	444.4 kcmil	—	3/8	1.70	2.69	.26	5.14	Brown	P87	20	87H	2 3/4	6
LCBX500-38-6				3/8	1.89	2.88	.26	4.84	Pink	P99	L99	99H	2 15/16	6
LCBX500-12-6	500 kcmil	535.3 kcmil	—	1/2	1.89	2.88	.26	5.03	Pink	P99	L99	99H	2 15/16	6

‡See pages D3.66 – D3.69 for tool and die information.

*Not UL Listed or CSA Certified with Class K flex conductor when crimped with Burndy tools.

**Consult cable manufacturer for voltage stress relief instructions with applications greater than 2000 V.



Flex Conductor, One-Hole, Long Barrel with Window Lug, 45° Angle

For Use with Flexible, Extra-Flexible, and Code Stranded Copper Conductors

Type LCBX-H

- Can be used with code conductor and flex conductor class: G, H, I, K, M and Diesel Locomotive
- Long barrel maximizes number of crimps and provides premium wire pull-out strength and electrical performance
- Generously beveled wire entry prevents bent back strands when inserting conductor into barrel
- Color-coded barrels marked with *PANDUIT* and specified competitor die index numbers for proper crimp die selection
- Inspection window to visually assure full conductor insertion
- Tin-plated to inhibit corrosion
- UL Listed and CSA Certified to 35 KV** and temperature rated to 90°C when crimped with *PANDUIT* and specified competitor crimping tools and dies
- Meets J-STD-607-A and TIA-942 requirements for network systems grounding applications

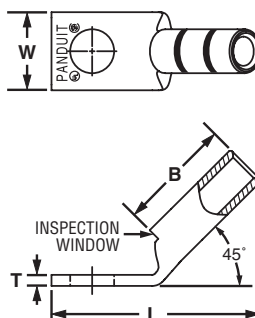

Part Number	Flex Conductor Size		Code Conductor Size	Stud Hole Size (In.)	Figure Dimensions (In.)				PANDUIT Color Code	PANDUIT Die Index No.‡	Burndy Die Index No.‡	T&B Die Index No.‡	Wire Strip Length (In.)	Std. Pkg. Qty.
	Class G, H, I, K, M	Diesel Locomotive			W	B	T	L						
LCBX8-10H-L				#10	.41	.70	.08	1.20	Red	P21	49	21	3/4	50
LCBX8-14H-L	#8 AWG	#8 AWG	#8 AWG	1/4	.48	.70	.07	1.28	Red	P21	49	21	3/4	50
LCBX8-38H-L				3/8	.60	.70	.05	1.49	Red	P21	49	21	3/4	50
LCBX6-14H-L	#6 AWG	#6 AWG	#6 AWG	1/4	.48	1.07	.08	1.56	Blue	P24	7	24	1 1/8	50
LCBX6-38H-L				3/8	.62	1.07	.06	1.77	Blue	P24	7	24	1 1/8	50
LCBX4-14H-L	#4 AWG	#5, #4, #3 AWG	#4 AWG	1/4	.55	1.05	.09	1.57	Gray	P29	8	29	1 1/8	50
LCBX4-38H-L				3/8	.62	1.05	.07	1.78	Gray	P29	8	29	1 1/8	50
LCBX2-14H-E*				1/4	.70	1.36	.11	1.83	Brown	P33	10	33	1 7/16	20
LCBX2-38H-E*	#2 AWG	#2 AWG	#2 AWG	3/8	.70	1.36	.11	2.03	Brown	P33	10	33	1 7/16	20
LCBX2-12H-E*				1/2	.75	1.36	.09	2.26	Brown	P33	10	33	1 7/16	20
LCBX1-14H-X	#1 AWG	#1 AWG	#1 AWG	1/4	.76	1.44	.12	1.98	Green	P37	11	37	1 1/2	10
LCBX1-56H-X				5/16	.76	1.44	.12	2.04	Green	P37	11	37	1 1/2	10
LCBX1-38H-X				3/8	.76	1.44	.12	2.11	Green	P37	11	37	1 1/2	10
LCBX1/0-14H-X	1/0 AWG	1/0 AWG	1/0 AWG	1/4	.85	1.50	.13	2.13	Pink	P42	12	42	1 9/16	10
LCBX1/0-38H-X				3/8	.85	1.50	.13	2.20	Pink	P42	12	42	1 9/16	10
LCBX1/0-12H-X				1/2	.85	1.50	.13	2.45	Pink	P42	12	42	1 9/16	10
LCBX2/0-14H-X	2/0 AWG	2/0 AWG	2/0 AWG	1/4	.96	1.50	.13	2.16	Black	P45	13	45	1 9/16	10
LCBX2/0-38H-X				3/8	.96	1.50	.13	2.22	Black	P45	13	45	1 9/16	10
LCBX2/0-12H-X				1/2	.96	1.50	.13	2.47	Black	P45	13	45	1 9/16	10
LCBX3/0-38H-X	3/0 AWG	3/0 AWG	3/0 AWG	3/8	1.06	1.56	.14	2.31	Orange	P50	14	50	1 5/8	10
LCBX4/0-38H-X	4/0 AWG	4/0 AWG	4/0 AWG	3/8	1.19	2.24	.16	3.12	Purple	P54	15	54	2 5/16	10
LCBX4/0-12H-X				1/2	1.19	2.24	.16	3.23	Purple	P54	15	54	2 5/16	10
LCBX250-38H-X	250 kcmil	262.6 kcmil	—	3/8	1.28	2.24	.17	3.15	Yellow	P62	16	62	2 5/16	10
LCBX300-38H-6	300 kcmil	313.1 kcmil	—	3/8	1.39	2.30	.18	3.42	Red	P71	18	71H	2 3/8	6
LCBX300-12H-6				1/2	1.39	2.30	.18	3.69	Red	P71	18	71H	2 3/8	6
LCBX350-38H-6	350 kcmil	373.7 kcmil	—	3/8	1.54	2.50	.22	3.48	Blue	P76	19	76H	2 9/16	6
LCBX350-12H-6				1/2	1.54	2.50	.22	3.64	Blue	P76	19	76H	2 9/16	6
LCBX450-38H-6	450 kcmil	444.4 kcmil	—	3/8	1.70	2.69	.26	4.42	Brown	P87	20	87H	2 3/4	6
LCBX500-38H-6	500 kcmil	535.3 kcmil	—	3/8	1.89	2.88	.26	4.08	Pink	P99	L99	99H	2 15/16	6
LCBX500-12H-6				1/2	1.89	2.88	.26	4.27	Pink	P99	L99	99H	2 15/16	6

‡See pages D3.66 – D3.69 for tool and die information.

*Not UL Listed or CSA Certified with Class K flex conductor when crimped with Burndy tools.

**Consult cable manufacturer for voltage stress relief instructions with applications greater than 2000 V.

A. System Overview

B1. Cable Ties

B2. Cable Accessories

B3. Stainless Steel Ties

C1. Wiring Duct

C2. Surface Raceway

C3. Abrasion Protection

C4. Cable Management

D1. Terminals

D2. Power Connectors

D3. Grounding Connectors

E1. Labeling Systems

E2. Labels

E3. Pre-Printed & Write-On Markers

E4. Permanent Identification

E5. Lockout/Tagout & Safety Solutions

F. Index

A. System Overview

B1. Cable Ties



Flex Conductor, One-Hole, Long Barrel with Window Lug, 90° Angle

For Use with Flexible, Extra-Flexible, and Code Stranded Copper Conductors

Type LCBX-F

- Can be used with code conductor and flex conductor class: G, H, I, K, M and Diesel Locomotive
- Long barrel maximizes number of crimps and provides premium wire pull-out strength and electrical performance
- Generously beveled wire entry prevents bent back strands when inserting conductor into barrel
- Color-coded barrels marked with *PANDUIT* and specified competitor die index numbers for proper crimp die selection
- Inspection window to visually assure full conductor insertion
- Tin-plated to inhibit corrosion
- UL Listed and CSA Certified to 35 KV** and temperature rated to 90°C when crimped with *PANDUIT* and specified competitor crimping tools and dies
- Meets J-STD-607-A and TIA-942 requirements for network systems grounding applications

C1. Wiring Duct

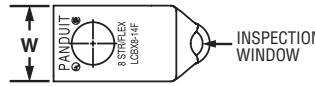

C2. Surface Raceway

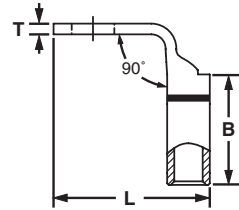

C3. Abrasion Protection

C4. Cable Management

D1. Terminals

D2. Power Connectors

D3. Grounding Connectors

E1. Labeling Systems

E2. Labels

E3. Pre-Printed & Write-On Markers

E4. Permanent Identification

E5. Lockout/Tagout & Safety Solutions

F. Index

Part Number	Flex Conductor Size		Code Conductor Size	Stud Hole Size (In.)	Figure Dimensions (In.)				PANDUIT Color Code	PANDUIT Die Index No.‡	Burndy Die Index No.‡	T&B Die Index No.‡	Wire Strip Length (In.)	Std. Pkg. Qty.
	Class G, H, I, K, M	Diesel Locomotive			W	B	T	L						
LCBX8-10F-L				#10	.41	.70	.08	.90	Red	P21	49	21	3/4	50
LCBX8-14F-L	#8 AWG	#8 AWG	#8 AWG	1/4	.48	.70	.07	.99	Red	P21	49	21	3/4	50
LCBX8-38F-L				3/8	.60	.70	.05	1.21	Red	P21	49	21	3/4	50
LCBX6-14F-L	#6 AWG	#6 AWG	#6 AWG	1/4	.48	1.07	.08	1.03	Blue	P24	7	24	1 1/8	50
LCBX6-38F-L				3/8	.62	1.07	.06	1.25	Blue	P24	7	24	1 1/8	50
LCBX4-14F-L	#4 AWG	#5, #4, #3 AWG	#4 AWG	1/4	.55	1.05	.09	1.12	Gray	P29	8	29	1 1/8	50
LCBX4-38F-L				3/8	.62	1.05	.07	1.34	Gray	P29	8	29	1 1/8	50
LCBX2-14F-E*				1/4	.70	1.36	.11	1.31	Brown	P33	10	33	1 7/16	20
LCBX2-38F-E*	#2 AWG	#2 AWG	#2 AWG	3/8	.70	1.36	.11	1.51	Brown	P33	10	33	1 7/16	20
LCBX2-12F-E*				1/2	.75	1.36	.09	1.75	Brown	P33	10	33	1 7/16	20
LCBX1-14F-X				1/4	.76	1.44	.12	1.45	Green	P37	11	37	1 1/2	10
LCBX1-56F-X	#1 AWG	#1 AWG	#1 AWG	5/16	.76	1.44	.12	1.51	Green	P37	11	37	1 1/2	10
LCBX1-38F-X				3/8	.76	1.44	.12	1.58	Green	P37	11	37	1 1/2	10
LCBX1/0-14F-X				1/4	.85	1.50	.13	1.61	Pink	P42	12	42	1 9/16	10
LCBX1/0-38F-X	1/0 AWG	1/0 AWG	1/0 AWG	3/8	.85	1.50	.13	1.66	Pink	P42	12	42	1 9/16	10
LCBX1/0-12F-X				1/2	.85	1.50	.13	1.91	Pink	P42	12	42	1 9/16	10
LCBX2/0-14F-X				1/4	.96	1.50	.13	1.67	Black	P45	13	45	1 9/16	10
LCBX2/0-38F-X	2/0 AWG	2/0 AWG	2/0 AWG	3/8	.96	1.50	.13	1.73	Black	P45	13	45	1 9/16	10
LCBX2/0-12F-X				1/2	.96	1.50	.13	1.98	Black	P45	13	45	1 9/16	10
LCBX3/0-38F-X	3/0 AWG	3/0 AWG	3/0 AWG	3/8	1.06	1.56	.14	1.84	Orange	P50	14	50	1 5/8	10
LCBX4/0-38F-X	4/0 AWG	4/0 AWG	4/0 AWG	3/8	1.19	2.24	.16	2.07	Purple	P54	15	54	2 5/16	10
LCBX4/0-12F-X				1/2	1.19	2.24	.16	2.18	Purple	P54	15	54	2 5/16	10
LCBX250-38F-X	250 kcmil	262.6 kcmil	—	3/8	1.28	2.24	.17	2.13	Yellow	P62	16	62	2 5/16	10
LCBX300-38F-6	300 kcmil	313.1 kcmil	—	3/8	1.39	2.30	.18	2.37	Red	P71	18	71H	2 3/8	6
LCBX300-12F-6				1/2	1.39	2.30	.18	2.37	Red	P71	18	71H	2 3/8	6
LCBX350-38F-6	350 kcmil	373.7 kcmil	—	3/8	1.54	2.50	.22	2.32	Blue	P76	19	76H	2 9/16	6
LCBX350-12F-6				1/2	1.54	2.50	.22	2.48	Blue	P76	19	76H	2 9/16	6
LCBX450-38F-6	450 kcmil	444.4 kcmil	—	3/8	1.70	2.69	.26	3.14	Brown	P87	20	87H	2 3/4	6
LCBX500-38F-6	500 kcmil	535.3 kcmil	—	3/8	1.89	2.88	.26	2.62	Pink	P99	L99	99H	2 15/16	6
LCBX500-12F-6				1/2	1.89	2.88	.26	2.81	Pink	P99	L99	99H	2 15/16	6

‡See pages D3.66 – D3.69 for tool and die information.
 *Not UL Listed or CSA Certified with Class K flex conductor when crimped with Burndy tools.
 **Consult cable manufacturer for voltage stress relief instructions with applications greater than 2000 V.



Flex Conductor, Two-Hole, Standard Barrel with Window Lug

For Use with Flexible, Extra-Flexible, and Code Stranded Copper Conductors

Type LCDX

- Can be used with code conductor and flex conductor class: G, H, I, K, M and Diesel Locomotive
- Generously beveled wire entry prevents bent back strands when inserting conductor into barrel
- Color-coded barrels marked with *PANDUIT* and specified competitor die index numbers for proper crimp die selection
- Inspection window to visually assure full conductor insertion
- Tin-plated to inhibit corrosion
- UL Listed and CSA Certified to 35 KV** and temperature rated to 90°C when crimped with *PANDUIT* and specified competitor crimping tools and dies
- American Bureau of Shipping approved
- Available with NEMA hole sizes and spacing

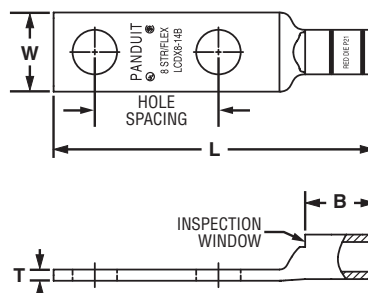

Part Number	Flex Conductor Size		Code Conductor Size	Stud Hole Size (In.)	Stud Hole Spacing (In.)	Figure Dimensions (In.)				PANDUIT Color Code	PANDUIT Die Index No.‡	Burndy Die Index No.‡	T&B Die Index No.‡	Wire Strip Length (In.)	Std. Pkg. Qty.
	Class G, H, I, K, M	Diesel Locomotive				W	B	T	L						
LCDX8-10A-L	#8 AWG	#8 AWG	#8 AWG	#10	.63	.41	.42	.08	1.74	Red	P21	49	21	1/2	50
LCDX8-14A-L				1/4	.63	.48	.42	.07	1.83	Red	P21	49	21	1/2	50
LCDX8-14B-L				1/4	.75	.48	.42	.07	1.95	Red	P21	49	21	1/2	50
LCDX8-14D-L				1/4	1.00	.48	.42	.07	2.20	Red	P21	49	21	1/2	50
LCDX8-38D-L				3/8	1.00	.60	.42	.05	2.42	Red	P21	49	21	1/2	50
LCDX6-10A-L	#6 AWG	#6 AWG	#6 AWG	#10	.63	.46	.48	.08	1.82	Blue	P24	7	24	9/16	50
LCDX6-10B-L				#10	.75	.46	.48	.08	1.94	Blue	P24	7	24	9/16	50
LCDX6-10G-L				#10	1.50	.46	.48	.08	2.69	Blue	P24	7	24	9/16	50
LCDX6-10P-L				#10	.69	.46	.48	.08	1.88	Blue	P24	7	24	9/16	50
LCDX6-14A-L				1/4	.63	.48	.48	.08	1.91	Blue	P24	7	24	9/16	50
LCDX6-14B-L				1/4	.75	.48	.48	.08	2.03	Blue	P24	7	24	9/16	50
LCDX6-14D-L				1/4	1.00	.48	.48	.08	2.28	Blue	P24	7	24	9/16	50
LCDX6-56D-L				5/16	1.00	.56	.48	.07	2.40	Blue	P24	7	24	9/16	50
LCDX6-38D-L				3/8	1.00	.62	.48	.06	2.50	Blue	P24	7	24	9/16	50
LCDX4-14A-L				#4 AWG	#5, #4, #3 AWG	#4 AWG	1/4	.63	.55	.53	.09	1.98	Gray	P29	8
LCDX4-14B-L	1/4	.75	.55				.53	.09	2.10	Gray	P29	8	29	5/8	50
LCDX4-14D-L	1/4	1.00	.55				.53	.09	2.35	Gray	P29	8	29	5/8	50
LCDX4-56D-L	5/16	1.00	.55				.53	.09	2.47	Gray	P29	8	29	5/8	50
LCDX4-38D-L	3/8	1.00	.62				.53	.08	2.57	Gray	P29	8	29	5/8	50
LCDX2-14A-E*	#2 AWG	#2 AWG	#2 AWG	1/4	.63	.70	.59	.11	2.13	Brown	P33	10	33	11/16	20
LCDX2-14B-E*				1/4	.75	.70	.59	.11	2.25	Brown	P33	10	33	11/16	20
LCDX2-14D-E*				1/4	1.00	.70	.59	.11	2.50	Brown	P33	10	33	11/16	20
LCDX2-56D-E*				5/16	1.00	.70	.59	.11	2.63	Brown	P33	10	33	11/16	20
LCDX2-38D-E*				3/8	1.00	.70	.59	.11	2.70	Brown	P33	10	33	11/16	20
LCDX2-12-E*				1/2	1.75	.75	.59	.09	3.87	Brown	P33	10	33	11/16	20
LCDX1-14A-X	#1 AWG	#1 AWG	#1 AWG	1/4	.63	.76	.66	.12	2.29	Green	P37	11	37	3/4	10
LCDX1-14B-X				1/4	.75	.76	.66	.12	2.42	Green	P37	11	37	3/4	10
LCDX1-14D-X				1/4	1.00	.76	.66	.12	2.67	Green	P37	11	37	3/4	10
LCDX1-56D-X				5/16	1.00	.76	.66	.12	2.72	Green	P37	11	37	3/4	10
LCDX1-38D-X				3/8	1.00	.76	.66	.12	2.80	Green	P37	11	37	3/4	10
LCDX1-12-X				1/2	1.75	.80	.66	.12	3.97	Green	P37	11	37	3/4	10

‡See pages D3.66 – D3.69 for tool and die information.

*Not UL Listed or CSA Certified with Class K flex conductor when crimped with Burndy tools.

**Consult cable manufacturer for voltage stress relief instructions with applications greater than 2000 V.

◆NEMA hole sizes and spacing.

Table continues on page D2.84

A. System Overview

B1. Cable Ties

B2. Cable Accessories

B3. Stainless Steel Ties

C1. Wiring Duct

C2. Surface Raceway

C3. Abrasion Protection

C4. Cable Management

D1. Terminals

D2. Power Connectors

D3. Grounding Connectors

E1. Labeling Systems

E2. Labels

E3. Pre-Printed & Write-On Markers

E4. Permanent Identification

E5. Lockout/Tagout & Safety Solutions

F. Index

A. System Overview

B1. Cable Ties

B2. Cable Accessories

B3. Stainless Steel Ties

C1. Wiring Duct

C2. Surface Raceway

C3. Abrasion Protection

C4. Cable Management

D1. Terminals

D2. Power Connectors

D3. Grounding Connectors

E1. Labeling Systems

E2. Labels

E3. Pre-Printed & Write-On Markers

E4. Permanent Identification

E5. Lockout/Tagout & Safety Solutions

F. Index



Flex Conductor, Two-Hole, Standard Barrel with Window Lug (continued)

Part Number	Flex Conductor Size		Code Conductor Size	Stud Hole Size (In.)	Stud Hole Spacing (In.)	Figure Dimensions (In.)				PANDUIT Color Code	PANDUIT Die Index No.‡	Burndy Die Index No.‡	T&B Die Index No.‡	Wire Strip Length (In.)	Std. Pkg. Qty.			
	Class G, H, I, K, M	Diesel Locomotive				W	B	T	L									
LCDX1/0-14A-X	1/0 AWG	1/0 AWG	1/0 AWG	1/4	.63	.85	.72	.13	2.45	Pink	P42	12	42	3/4	10			
LCDX1/0-14B-X				1/4	.75	.85	.72	.13	2.57	Pink	P42	12	42	3/4	10			
LCDX1/0-56B-X				5/16	.75	.85	.72	.13	2.57	Pink	P42	12	42	3/4	10			
LCDX1/0-56D-X				5/16	1.00	.85	.72	.13	2.82	Pink	P42	12	42	3/4	10			
LCDX1/0-38D-X				3/8	1.00	.85	.72	.13	2.89	Pink	P42	12	42	3/4	10			
LCDX1/0-12D-X				1/2	1.00	.85	.72	.13	3.14	Pink	P42	12	42	3/4	10			
LCDX1/0-12-X	2/0 AWG	2/0 AWG	2/0 AWG	1/2	1.75	.85	.72	.13	4.05	Pink	P42	12	42	3/4	10			
LCDX2/0-14A-X				1/4	.63	.96	.83	.13	2.59	Black	P45	13	45	7/8	10			
LCDX2/0-14B-X				1/4	.75	.96	.83	.13	2.72	Black	P45	13	45	7/8	10			
LCDX2/0-56D-X				5/16	1.00	.96	.83	.13	2.97	Black	P45	13	45	7/8	10			
LCDX2/0-38D-X				3/8	1.00	.96	.83	.13	3.03	Black	P45	13	45	7/8	10			
LCDX2/0-12D-X				1/2	1.00	.96	.83	.13	3.28	Black	P45	13	45	7/8	10			
LCDX2/0-12-X	3/0 AWG	3/0 AWG	3/0 AWG	1/2	1.75	.96	.83	.13	4.19	Black	P45	13	45	7/8	10			
LCDX3/0-14A-X				1/4	.63	1.06	.91	.14	2.71	Orange	P50	14	50	1	10			
LCDX3/0-56D-X				5/16	1.00	1.06	.91	.14	3.10	Orange	P50	14	50	1	10			
LCDX3/0-38D-X				3/8	1.00	1.06	.91	.14	3.17	Orange	P50	14	50	1	10			
LCDX3/0-12-X				1/2	1.75	1.06	.91	.14	4.31	Orange	P50	14	50	1	10			
LCDX4/0-14A-X				4/0 AWG	4/0 AWG	4/0 AWG	1/4	.63	1.19	1.03	.16	2.74	Purple	P54	15	54	1 1/16	10
LCDX4/0-14B-X	1/4	.75	1.19				1.03	.16	2.96	Purple	P54	15	54	1 1/16	10			
LCDX4/0-56D-X	5/16	1.00	1.19				1.03	.16	3.31	Purple	P54	15	54	1 1/16	10			
LCDX4/0-38D-X	3/8	1.00	1.19				1.03	.16	3.34	Purple	P54	15	54	1 1/16	10			
LCDX4/0-12D-X	1/2	1.00	1.19				1.03	.16	3.61	Purple	P54	15	54	1 1/16	10			
LCDX4/0-12E-X	1/2	1.25	1.19				1.03	.16	3.89	Purple	P54	15	54	1 1/16	10			
LCDX4/0-12-X	250 kcmil	262.6 kcmil	—	1/2	1.75	1.19	1.03	.16	4.52	Purple	P54	15	54	1 1/16	10			
LCDX250-38D-X				3/8	1.00	1.28	1.03	.17	3.38	Yellow	P62	16	62	1 1/16	10			
LCDX250-38-X				3/8	1.75	1.28	1.03	.17	4.13	Yellow	P62	16	62	1 1/16	10			
LCDX250-12E-X				1/2	1.25	1.28	1.03	.17	3.93	Yellow	P62	16	62	1 1/16	10			
LCDX250-12-X				1/2	1.75	1.28	1.03	.17	4.56	Yellow	P62	16	62	1 1/16	10			
LCDX300-38D-6				300 kcmil	313.1 kcmil	—	3/8	1.00	1.39	1.19	.18	3.56	Red	P71	18	71H	1 1/4	6
LCDX300-12-6	1/2	1.75	1.39				1.19	.18	4.74	Red	P71	18	71H	1 1/4	6			
LCDX350-56D-6	5/16	1.00	1.54				1.29	.22	3.71	Blue	P76	19	76H	1 3/8	6			
LCDX350-38D-6	3/8	1.00	1.54				1.29	.22	3.74	Blue	P76	19	76H	1 3/8	6			
LCDX350-38-6	3/8	1.75	1.54				1.29	.22	4.49	Blue	P76	19	76H	1 3/8	6			
LCDX350-12E-6	1/2	1.25	1.54				1.29	.22	4.29	Blue	P76	19	76H	1 3/8	6			
LCDX350-12-6	350 kcmil	373.7 kcmil	—	1/2	1.75	1.54	1.29	.22	4.92	Blue	P76	19	76H	1 3/8	6			
LCDX450-38D-6				3/8	1.00	1.70	1.40	.26	3.90	Brown	P87	20	87H	1 7/16	6			
LCDX450-12-6				1/2	1.75	1.70	1.40	.26	5.08	Brown	P87	20	87H	1 7/16	6			
LCDX500-56D-6				450 kcmil	444.4 kcmil	—	5/16	1.00	1.89	1.48	.26	4.05	Pink	P99	L99	99H	1 9/16	6
LCDX500-38D-6							3/8	1.00	1.89	1.48	.26	4.08	Pink	P99	L99	99H	1 9/16	6
LCDX500-12E-6							1/2	1.25	1.89	1.48	.26	4.76	Pink	P99	L99	99H	1 9/16	6
LCDX500-12-6	1/2	1.75	1.89				1.48	.26	5.26	Pink	P99	L99	99H	1 9/16	6			
LCDX600-12-6	600 kcmil	—	—				1/2	1.75	1.89	1.48	.26	5.26	Pink	P99	400	99H	1 9/16	6
LCDX650-38D-6	3/8	1.00	1.95				1.45	.30	4.08	Black	P106	24	106H	1 1/2	6			
LCDX650-12-6	—	646.4 kcmil	—	1/2	1.75	1.95	1.45	.30	5.26	Black	P106	24	106H	1 1/2	6			
LCDX750-38D-3	—	777.7 kcmil	—	3/8	1.00	2.17	1.66	.32	4.62	Yellow	P115	L115	115H	1 3/4	3			
LCDX750-12E-3				1/2	1.25	2.17	1.66	.32	5.06	Yellow	P115	L115	115H	1 3/4	3			
LCDX750-12G-3				1/2	1.50	2.17	1.66	.32	5.31	Yellow	P115	L115	115H	1 3/4	3			
LCDX750-12-3				1/2	1.75	2.17	1.66	.32	5.56	Yellow	P115	L115	115H	1 3/4	3			
LCDX750-58G-3				5/8	1.50	2.17	1.66	.32	5.37	Yellow	P115	L115	115H	1 3/4	3			

‡See pages D3.66 – D3.69 for tool and die information.

*Not UL Listed or CSA Certified with Class K flex conductor when crimped with Burndy tools.

**Consult cable manufacturer for voltage stress relief instructions with applications greater than 2000 V.

◆NEMA hole sizes and spacing.



Flex Conductor, Two-Hole, Standard Barrel with Window Lug, 45° Angle

For Use with Flexible, Extra-Flexible, and Code Stranded Copper Conductors

Type LCDX-H

- Can be used with code conductor and flex conductor class: G, H, I, K, M and Diesel Locomotive
- Generously beveled wire entry prevents bent back strands when inserting conductor into barrel
- Color-coded barrels marked with *PANDUIT* and specified competitor die index numbers for proper crimp die selection
- Inspection window to visually assure full conductor insertion
- Tin-plated to inhibit corrosion
- UL Listed and CSA Certified to 35 KV** and temperature rated to 90°C when crimped with *PANDUIT* and specified competitor crimping tools and dies
- American Bureau of Shipping approved
- Available with NEMA hole sizes and spacing

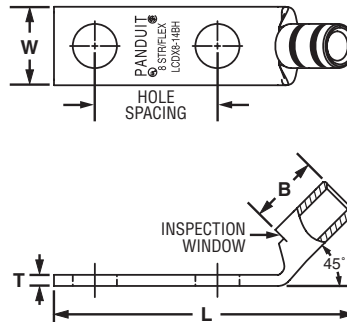

A. System Overview

B1. Cable Ties

B2. Cable Accessories

B3. Stainless Steel Ties

C1. Wiring Duct

C2. Surface Raceway

C3. Abrasion Protection

C4. Cable Management

D1. Terminals

D2. Power Connectors

D3. Grounding Connectors

E1. Labeling Systems

E2. Labels

E3. Pre-Printed & Write-On Markers

E4. Permanent Identification

E5. Lockout/Tagout & Safety Solutions

F. Index

Part Number	Flex Conductor Size		Code Conductor Size	Stud Hole Size (In.)	Stud Hole Spacing (In.)	Figure Dimensions (In.)				PANDUIT Color Code	PANDUIT Die Index No.‡	Burndy Die Index No.‡	T&B Die Index No.‡	Wire Strip Length (In.)	Std. Pkg. Qty.
	Class G, H, I, K, M	Diesel Locomotive				W	B	T	L						
LCDX8-10AH-L	#8 AWG	#8 AWG	#8 AWG	#10	.63	.41	.42	.08	1.63	Red	P21	49	21	1/2	50
LCDX8-14AH-L				1/4	.63	.48	.42	.07	1.71	Red	P21	49	21	1/2	50
LCDX8-14BH-L				1/4	.75	.48	.42	.07	1.84	Red	P21	49	21	1/2	50
LCDX8-14DH-L				1/4	1.00	.48	.42	.07	2.09	Red	P21	49	21	1/2	50
LCDX8-38DH-L				3/8	1.00	.60	.42	.05	2.30	Red	P21	49	21	1/2	50
LCDX6-10AH-L	#6 AWG	#6 AWG	#6 AWG	#10	.63	.46	.48	.08	1.68	Blue	P24	7	24	9/16	50
LCDX6-10BH-L				#10	.75	.46	.48	.08	1.81	Blue	P24	7	24	9/16	50
LCDX6-10GH-L				#10	1.50	.46	.48	.08	2.56	Blue	P24	7	24	9/16	50
LCDX6-10PH-L				#10	.69	.46	.48	.08	1.74	Blue	P24	7	24	9/16	50
LCDX6-14AH-L				1/4	.63	.48	.48	.08	1.77	Blue	P24	7	24	9/16	50
LCDX6-14BH-L				1/4	.75	.48	.48	.08	1.89	Blue	P24	7	24	9/16	50
LCDX6-14DH-L				1/4	1.00	.48	.48	.08	2.14	Blue	P24	7	24	9/16	50
LCDX6-56DH-L				5/16	1.00	.56	.48	.07	2.26	Blue	P24	7	24	9/16	50
LCDX6-38DH-L				3/8	1.00	.62	.48	.06	2.35	Blue	P24	7	24	9/16	50
LCDX4-14AH-L				#4 AWG	#5, #4, #3 AWG	#4 AWG	1/4	.63	.55	.53	.09	1.83	Gray	P29	8
LCDX4-14BH-L	1/4	.75	.55				.53	.09	1.96	Gray	P29	8	29	5/8	50
LCDX4-14DH-L	1/4	1.00	.55				.53	.09	2.21	Gray	P29	8	29	5/8	50
LCDX4-56DH-L	5/16	1.00	.55				.53	.09	2.33	Gray	P29	8	29	5/8	50
LCDX4-38DH-L	3/8	1.00	.62	.53	.08	2.42	Gray	P29	8	29	5/8	50			
LCDX2-14AH-E*	#2 AWG	#2 AWG	#2 AWG	1/4	.63	.70	.59	.11	1.92	Brown	P33	10	33	11/16	20
LCDX2-14BH-E*				1/4	.75	.70	.59	.11	2.04	Brown	P33	10	33	11/16	20
LCDX2-14DH-E*				1/4	1.00	.70	.59	.11	2.29	Brown	P33	10	33	11/16	20
LCDX2-56DH-E*				5/16	1.00	.70	.59	.11	2.42	Brown	P33	10	33	11/16	20
LCDX2-38DH-E*				3/8	1.00	.70	.59	.11	2.49	Brown	P33	10	33	11/16	20
LCDX2-12H-E*	1/2	1.75	.75	.59	.09	3.66	Brown	P33	10	33	11/16	20			
LCDX1-14AH-X	#1 AWG	#1 AWG	#1 AWG	1/4	.63	.76	.66	.12	2.06	Green	P37	11	37	3/4	10
LCDX1-14BH-X				1/4	.75	.76	.66	.12	2.18	Green	P37	11	37	3/4	10
LCDX1-14DH-X				1/4	1.00	.76	.66	.12	2.43	Green	P37	11	37	3/4	10
LCDX1-56DH-X				5/16	1.00	.76	.66	.12	2.49	Green	P37	11	37	3/4	10
LCDX1-38DH-X				3/8	1.00	.76	.66	.12	2.56	Green	P37	11	37	3/4	10
LCDX1-12H-X				1/2	1.75	.80	.66	.12	3.73	Green	P37	11	37	3/4	10

‡See pages D3.66 – D3.69 for tool and die information.

*Not UL Listed or CSA Certified with Class K flex conductor when crimped with Burndy tools.

**Consult cable manufacturer for voltage stress relief instructions with applications greater than 2000 V.

◆NEMA hole sizes and spacing.

Table continues on page D2.86

A. System Overview

B1. Cable Ties



Flex Conductor, Two-Hole, Standard Barrel with Window Lug, 45° Angle (continued)

B2. Cable Accessories

B3. Stainless Steel Ties

C1. Wiring Duct

C2. Surface Raceway

C3. Abrasion Protection

C4. Cable Management

D1. Terminals

D2. Power Connectors

D3. Grounding Connectors

E1. Labeling Systems

E2. Labels

E3. Pre-Printed & Write-On Markers

E4. Permanent Identification

E5. Lockout/Tagout & Safety Solutions

F. Index

Part Number	Flex Conductor Size		Code Conductor Size	Stud Hole Size (In.)	Stud Hole Spacing (In.)	Figure Dimensions (In.)				PANDUIT Color Code	PANDUIT Die Index No.‡	Burndy Die Index No.‡	T&B Die Index No.‡	Wire Strip Length (In.)	Std. Pkg. Qty.			
	Class G, H, I, K, M	Diesel Locomotive				W	B	T	L									
LCDX1/0-14AH-X	1/0 AWG	1/0 AWG	1/0 AWG	1/4	.63	.85	.72	.13	2.21	Pink	P42	12	42	3/4	10			
LCDX1/0-14BH-X				1/4	.75	.85	.72	.13	2.33	Pink	P42	12	42	3/4	10			
LCDX1/0-56BH-X				5/16	.75	.85	.72	.13	2.33	Pink	P42	12	42	3/4	10			
LCDX1/0-56DH-X				5/16	1.00	.85	.72	.13	2.58	Pink	P42	12	42	3/4	10			
LCDX1/0-38DH-X				3/8	1.00	.85	.72	.13	2.64	Pink	P42	12	42	3/4	10			
LCDX1/0-12DH-X				1/2	1.00	.85	.72	.13	2.89	Pink	P42	12	42	3/4	10			
LCDX1/0-12H-X				1/2	1.75	.85	.72	.13	3.81	Pink	P42	12	42	3/4	10			
LCDX2/0-14AH-X				2/0 AWG	2/0 AWG	2/0 AWG	1/4	.63	.96	.83	.13	2.30	Black	P45	13	45	7/8	10
LCDX2/0-14BH-X							1/4	.75	.96	.83	.13	2.43	Black	P45	13	45	7/8	10
LCDX2/0-56DH-X							5/16	1.00	.96	.83	.13	2.68	Black	P45	13	45	7/8	10
LCDX2/0-38DH-X	3/8	1.00	.96				.83	.13	2.74	Black	P45	13	45	7/8	10			
LCDX2/0-12DH-X	1/2	1.00	.96				.83	.13	3.03	Black	P45	13	45	7/8	10			
LCDX2/0-12H-X	1/2	1.75	.96				.83	.13	3.90	Black	P45	13	45	7/8	10			
LCDX3/0-14AH-X	3/0 AWG	3/0 AWG	3/0 AWG	1/4	.63	1.06	.91	.14	2.39	Orange	P50	14	50	1	10			
LCDX3/0-56DH-X				5/16	1.00	1.06	.91	.14	2.78	Orange	P50	14	50	1	10			
LCDX3/0-38DH-X				3/8	1.00	1.06	.91	.14	2.85	Orange	P50	14	50	1	10			
LCDX3/0-12H-X				1/2	1.75	1.06	.91	.14	3.99	Orange	P50	14	50	1	10			
LCDX4/0-14AH-X	4/0 AWG	4/0 AWG	4/0 AWG	1/4	.63	1.19	1.03	.16	2.67	Purple	P54	15	54	1 1/16	10			
LCDX4/0-14BH-X				1/4	.75	1.19	1.03	.16	2.79	Purple	P54	15	54	1 1/16	10			
LCDX4/0-56DH-X				5/16	1.00	1.19	1.03	.16	3.04	Purple	P54	15	54	1 1/16	10			
LCDX4/0-38DH-X				3/8	1.00	1.19	1.03	.16	3.07	Purple	P54	15	54	1 1/16	10			
LCDX4/0-12DH-X				1/2	1.00	1.19	1.03	.16	3.36	Purple	P54	15	54	1 1/16	10			
LCDX4/0-12EH-X				1/2	1.25	1.19	1.03	.16	3.62	Purple	P54	15	54	1 1/16	10			
LCDX4/0-12H-X	1/2	1.75	1.19	1.03	.16	4.25	Purple	P54	15	54	1 1/16	10						
LCDX250-38DH-X	250 kcmil	262.6 kcmil	—	3/8	1.00	1.28	1.03	.17	3.11	Yellow	P62	16	62	1 1/16	10			
LCDX250-38H-X				3/8	1.75	1.28	1.03	.17	3.86	Yellow	P62	16	62	1 1/16	10			
LCDX250-12EH-X				1/2	1.25	1.28	1.03	.17	3.66	Yellow	P62	16	62	1 1/16	10			
LCDX250-12H-X				1/2	1.75	1.28	1.03	.17	4.29	Yellow	P62	16	62	1 1/16	10			
LCDX300-38DH-6	300 kcmil	313.1 kcmil	—	3/8	1.00	1.39	1.19	.18	3.29	Red	P71	18	71H	1 1/4	6			
LCDX300-12H-6				1/2	1.75	1.39	1.19	.18	4.47	Red	P71	18	71H	1 1/4	6			
LCDX350-56DH-6	350 kcmil	373.7 kcmil	—	5/16	1.00	1.54	1.29	.22	3.40	Blue	P76	19	76H	1 3/8	6			
LCDX350-38DH-6				3/8	1.00	1.54	1.29	.22	3.43	Blue	P76	19	76H	1 3/8	6			
LCDX350-38H-6				3/8	1.75	1.54	1.29	.22	4.18	Blue	P76	19	76H	1 3/8	6			
LCDX350-12EH-6				1/2	1.25	1.54	1.29	.22	3.98	Blue	P76	19	76H	1 3/8	6			
LCDX350-12H-6	1/2	1.75	1.54	1.29	.22	4.61	Blue	P76	19	76H	1 3/8	6						
LCDX450-38DH-6	450 kcmil	444.4 kcmil	—	3/8	1.00	1.70	1.40	.26	3.75	Brown	P87	20	87H	1 7/16	6			
LCDX450-12H-6				1/2	1.75	1.70	1.40	.26	4.74	Brown	P87	20	87H	1 7/16	6			
LCDX500-56DH-6	500 kcmil	535.3 kcmil	—	5/16	1.00	1.89	1.48	.26	3.70	Pink	P99	L99	99H	1 9/16	6			
LCDX500-38DH-6				3/8	1.00	1.89	1.48	.26	3.73	Pink	P99	L99	99H	1 9/16	6			
LCDX500-12EH-6				1/2	1.25	1.89	1.48	.26	4.41	Pink	P99	L99	99H	1 9/16	6			
LCDX500-12H-6				1/2	1.75	1.89	1.48	.26	4.91	Pink	P99	L99	99H	1 9/16	6			
LCDX600-12H-6	600 kcmil	—	—	1/2	1.75	1.89	1.48	.26	4.91	Pink	P99	400	99H	1 9/16	6			
LCDX650-38DH-6	—	646.4 kcmil	—	3/8	1.00	1.95	1.45	.30	3.74	Black	P106	24	106H	1 1/2	6			
LCDX650-12H-6				1/2	1.75	1.95	1.45	.30	4.92	Black	P106	24	106H	1 1/2	6			
LCDX750-38DH-3	—	777.7 kcmil	—	3/8	1.00	2.17	1.66	.32	4.21	Yellow	P115	L115	115H	1 3/4	3			
LCDX750-12EH-3				1/2	1.25	2.17	1.66	.32	4.65	Yellow	P115	L115	115H	1 3/4	3			
LCDX750-12GH-3				1/2	1.50	2.17	1.66	.32	4.90	Yellow	P115	L115	115H	1 3/4	3			
LCDX750-12H-3				1/2	1.75	2.17	1.66	.32	5.15	Yellow	P115	L115	115H	1 3/4	3			
LCDX750-58GH-3	5/8	1.50	2.17	1.66	.32	4.90	Yellow	P115	L115	115H	1 3/4	3						

‡See pages D3.66 – D3.69 for tool and die information.
 **Consult cable manufacturer for voltage stress relief instructions with applications greater than 2000 V.
 ◆NEMA hole sizes and spacing.



Flex Conductor, Two-Hole, Standard Barrel with Window Lug, 90° Angle

For Use with Flexible, Extra-Flexible, and Code Stranded Copper Conductors

Type LCDX-F

- Can be used with code conductor and flex conductor class: G, H, I, K, M and Diesel Locomotive
- Generously beveled wire entry prevents bent back strands when inserting conductor into barrel
- Color-coded barrels marked with *PANDUIT* and specified competitor die index numbers for proper crimp die selection
- Inspection window to visually assure full conductor insertion
- Tin-plated to inhibit corrosion
- UL Listed and CSA Certified to 35 KV** and temperature rated to 90°C when crimped with *PANDUIT* and specified competitor crimping tools and dies
- American Bureau of Shipping approved
- Available with NEMA hole sizes and spacing

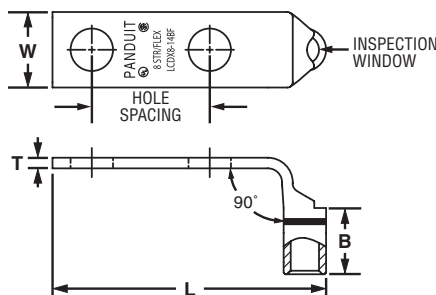

Part Number	Flex Conductor Size		Code Conductor Size	Stud Hole Size (In.)	Stud Hole Spacing (In.)	Figure Dimensions (In.)				PANDUIT Color Code	PANDUIT Die Index No.‡	Burndy Die Index No.‡	T&B Die Index No.‡	Wire Strip Length (In.)	Std. Pkg. Qty.
	Class G, H, I, K, M	Diesel Locomotive				W	B	T	L						
LCDX8-10AF-L	#8 AWG	#8 AWG	#8 AWG	#10	.63	.41	.42	.08	1.53	Red	P21	49	21	1/2	50
LCDX8-14AF-L				1/4	.63	.48	.42	.07	1.62	Red	P21	49	21	1/2	50
LCDX8-14BF-L				1/4	.75	.48	.42	.07	1.74	Red	P21	49	21	1/2	50
LCDX8-14DF-L				1/4	1.00	.48	.42	.07	1.99	Red	P21	49	21	1/2	50
LCDX8-38DF-L				3/8	1.00	.63	.42	.05	2.21	Red	P21	49	21	1/2	50
LCDX6-10AF-L	#6 AWG	#6 AWG	#6 AWG	#10	.63	.46	.48	.08	1.57	Blue	P24	7	24	9/16	50
LCDX6-10BF-L				#10	.75	.46	.48	.08	1.69	Blue	P24	7	24	9/16	50
LCDX6-10GF-L				#10	1.50	.46	.48	.08	2.44	Blue	P24	7	24	9/16	50
LCDX6-10PF-L				#10	.69	.46	.48	.08	1.63	Blue	P24	7	24	9/16	50
LCDX6-14AF-L				1/4	.63	.48	.48	.08	1.66	Blue	P24	7	24	9/16	50
LCDX6-14BF-L				1/4	.75	.48	.48	.08	1.78	Blue	P24	7	24	9/16	50
LCDX6-14DF-L				1/4	1.00	.48	.48	.08	2.03	Blue	P24	7	24	9/16	50
LCDX6-56DF-L				5/16	1.00	.56	.48	.07	2.15	Blue	P24	7	24	9/16	50
LCDX6-38DF-L				3/8	1.00	.62	.48	.06	2.25	Blue	P24	7	24	9/16	50
LCDX4-14AF-L				#4 AWG	#5, #4, #3 AWG	#4 AWG	1/4	.63	.55	.53	.09	1.74	Gray	P29	8
LCDX4-14BF-L	1/4	.75	.55				.53	.09	1.87	Gray	P29	8	29	5/8	50
LCDX4-14DF-L	1/4	1.00	.55				.53	.09	2.12	Gray	P29	8	29	5/8	50
LCDX4-56DF-L	5/16	1.00	.55				.53	.09	2.24	Gray	P29	8	29	5/8	50
LCDX4-38DF-L	3/8	1.00	.62				.53	.08	2.34	Gray	P29	8	29	5/8	50
LCDX2-14AF-E*	#2 AWG	#2 AWG	#2 AWG	1/4	.63	.70	.59	.11	1.94	Brown	P33	10	33	11/16	20
LCDX2-14BF-E*				1/4	.75	.70	.59	.11	2.06	Brown	P33	10	33	11/16	20
LCDX2-14DF-E*				1/4	1.00	.70	.59	.11	2.31	Brown	P33	10	33	11/16	20
LCDX2-56DF-E*				5/16	1.00	.70	.59	.11	2.44	Brown	P33	10	33	11/16	20
LCDX2-38DF-E*				3/8	1.00	.70	.59	.11	2.51	Brown	P33	10	33	11/16	20
LCDX2-12F-E*	1/2	1.75	.75	.59	.09	3.68	Brown	P33	10	33	11/16	20			
LCDX1-14AF-X	#1 AWG	#1 AWG	#1 AWG	1/4	.63	.76	.66	.12	2.08	Green	P37	11	37	3/4	10
LCDX1-14BF-X				1/4	.75	.76	.66	.12	2.20	Green	P37	11	37	3/4	10
LCDX1-14DF-X				1/4	1.00	.76	.66	.12	2.45	Green	P37	11	37	3/4	10
LCDX1-56DF-X				5/16	1.00	.76	.66	.12	2.51	Green	P37	11	37	3/4	10
LCDX1-38DF-X				3/8	1.00	.76	.66	.12	2.58	Green	P37	11	37	3/4	10
LCDX1-12F-X				1/2	1.75	.80	.66	.12	3.75	Green	P37	11	37	3/4	10

‡See pages D3.66 – D3.69 for tool and die information.

*Not UL Listed or CSA Certified with Class K flex conductor when crimped with Burndy tools.

**Consult cable manufacturer for voltage stress relief instructions with applications greater than 2000 V.

Table continues on page D2.88

A. System Overview

B1. Cable Ties

B2. Cable Accessories

B3. Stainless Steel Ties

C1. Wiring Duct

C2. Surface Raceway

C3. Abrasion Protection

C4. Cable Management

D1. Terminals

D2. Power Connectors

D3. Grounding Connectors

E1. Labeling Systems

E2. Labels

E3. Pre-Printed & Write-On Markers

E4. Permanent Identification

E5. Lockout/Tagout & Safety Solutions

F. Index

A. System Overview

B1. Cable Ties



Flex Conductor, Two-Hole, Standard Barrel with Window Lug, 90° Angle (continued)

B2. Cable Accessories

B3. Stainless Steel Ties

C1. Wiring Duct

C2. Surface Raceway

C3. Abrasion Protection

C4. Cable Management

D1. Terminals

D2. Power Connectors

D3. Grounding Connectors

E1. Labeling Systems

E2. Labels

E3. Pre-Printed & Write-On Markers

E4. Permanent Identification

E5. Lockout/Tagout & Safety Solutions

Part Number	Flex Conductor Size		Code Conductor Size	Stud Hole Size (In.)	Stud Hole Spacing (In.)	Figure Dimensions (In.)				PANDUIT Color Code	PANDUIT Die Index No.‡	Burdny Die Index No.‡	T&B Die Index No.‡	Wire Strip Length (In.)	Std. Pkg. Qty.
	Class G, H, I, K, M	Diesel Locomotive				W	B	T	L						
LCDX1/0-14AF-X				1/4	.63	.85	.72	.13	2.22	Pink	P42	12	42	3/4	10
LCDX1/0-14BF-X				1/4	.75	.85	.72	.13	2.34	Pink	P42	12	42	3/4	10
LCDX1/0-56BF-X				5/16	.75	.85	.72	.13	2.34	Pink	P42	12	42	3/4	10
LCDX1/0-56DF-X				5/16	1.00	.85	.72	.13	2.59	Pink	P42	12	42	3/4	10
LCDX1/0-38DF-X				3/8	1.00	.85	.72	.13	2.66	Pink	P42	12	42	3/4	10
LCDX1/0-12DF-X				1/2	1.00	.85	.72	.13	2.91	Pink	P42	12	42	3/4	10
LCDX1/0-12F-X				1/2	1.75	.85	.72	.13	3.82	Pink	P42	12	42	3/4	10
LCDX2/0-14AF-X				1/4	.63	.96	.83	.13	2.29	Black	P45	13	45	7/8	10
LCDX2/0-14BF-X				1/4	.75	.96	.83	.13	2.42	Black	P45	13	45	7/8	10
LCDX2/0-56DF-X				5/16	1.00	.96	.83	.13	2.67	Black	P45	13	45	7/8	10
LCDX2/0-38DF-X				3/8	1.00	.96	.83	.13	2.73	Black	P45	13	45	7/8	10
LCDX2/0-12DF-X				1/2	1.00	.96	.83	.13	2.98	Black	P45	13	45	7/8	10
LCDX2/0-12F-X				1/2	1.75	.96	.83	.13	3.89	Black	P45	13	45	7/8	10
LCDX3/0-14AF-X				1/4	.63	1.06	.91	.14	2.38	Orange	P50	14	50	1	10
LCDX3/0-56DF-X				5/16	1.00	1.06	.91	.14	2.77	Orange	P50	14	50	1	10
LCDX3/0-38DF-X				3/8	1.00	1.06	.91	.14	2.84	Orange	P50	14	50	1	10
LCDX3/0-12F-X				1/2	1.75	1.06	.91	.14	3.98	Orange	P50	14	50	1	10
LCDX4/0-14AF-X				1/4	.63	1.19	1.03	.16	2.28	Purple	P54	15	54	1 1/16	10
LCDX4/0-14BF-X				1/4	.75	1.19	1.03	.16	2.40	Purple	P54	15	54	1 1/16	10
LCDX4/0-56DF-X				5/16	1.00	1.19	1.03	.16	2.85	Purple	P54	15	54	1 1/16	10
LCDX4/0-38DF-X				3/8	1.00	1.19	1.03	.16	2.88	Purple	P54	15	54	1 1/16	10
LCDX4/0-12DF-X				1/2	1.00	1.19	1.03	.16	3.15	Purple	P54	15	54	1 1/16	10
LCDX4/0-12EF-X				1/2	1.25	1.19	1.03	.16	3.43	Purple	P54	15	54	1 1/16	10
LCDX4/0-12F-X				1/2	1.75	1.19	1.03	.16	4.06	Purple	P54	15	54	1 1/16	10
LCDX250-38DF-X				3/8	1.00	1.28	1.03	.17	2.94	Yellow	P62	16	62	1 1/16	10
LCDX250-38F-X				3/8	1.75	1.28	1.03	.17	3.69	Yellow	P62	16	62	1 1/16	10
LCDX250-12EF-X				1/2	1.25	1.28	1.03	.17	3.49	Yellow	P62	16	62	1 1/16	10
LCDX250-12F-X				1/2	1.75	1.28	1.03	.17	4.12	Yellow	P62	16	62	1 1/16	10
LCDX300-38DF-6				3/8	1.00	1.39	1.19	.18	3.02	Red	P71	18	71H	1 1/4	6
LCDX300-12F-6				1/2	1.75	1.39	1.19	.18	4.20	Red	P71	18	71H	1 1/4	6
LCDX350-56DF-6				5/16	1.00	1.54	1.29	.22	3.10	Blue	P76	19	76H	1 3/8	6
LCDX350-38DF-6				3/8	1.00	1.54	1.29	.22	3.13	Blue	P76	19	76H	1 3/8	6
LCDX350-38F-6				3/8	1.75	1.54	1.29	.22	3.88	Blue	P76	19	76H	1 3/8	6
LCDX350-12EF-6				1/2	1.25	1.54	1.29	.22	3.68	Blue	P76	19	76H	1 3/8	6
LCDX350-12F-6				1/2	1.75	1.54	1.29	.22	4.31	Blue	P76	19	76H	1 3/8	6
LCDX450-38DF-6				3/8	1.00	1.70	1.40	.26	3.26	Brown	P87	20	87H	1 7/16	6
LCDX450-12F-6				1/2	1.75	1.70	1.40	.26	4.44	Brown	P87	20	87H	1 7/16	6
LCDX500-56DF-6				5/16	1.00	1.89	1.48	.26	3.29	Pink	P99	L99	99H	1 9/16	6
LCDX500-38DF-6				3/8	1.00	1.89	1.48	.26	3.32	Pink	P99	L99	99H	1 9/16	6
LCDX500-12EF-6				1/2	1.25	1.89	1.48	.26	4.00	Pink	P99	L99	99H	1 9/16	6
LCDX500-12F-6				1/2	1.75	1.89	1.48	.26	4.50	Pink	P99	L99	99H	1 9/16	6
LCDX600-12F-6				1/2	1.75	1.89	1.48	.26	4.50	Pink	P99	400	99H	1 9/16	6
LCDX650-38DF-6				3/8	1.00	1.95	1.45	.30	3.37	Black	P106	24	106H	1 1/2	6
LCDX650-12F-6				1/2	1.75	1.95	1.45	.30	4.55	Black	P106	24	106H	1 1/2	6
LCDX750-38DF-3				3/8	1.00	2.17	1.66	.32	3.76	Yellow	P115	L115	115H	1 3/4	3
LCDX750-12EF-3				1/2	1.25	2.17	1.66	.32	4.20	Yellow	P115	L115	115H	1 3/4	3
LCDX750-12GF-3				1/2	1.50	2.17	1.66	.32	4.45	Yellow	P115	L115	115H	1 3/4	3
LCDX750-12F-3				1/2	1.75	2.17	1.66	.32	4.70	Yellow	P115	L115	115H	1 3/4	3
LCDX750-58GF-3				5/8	1.50	2.17	1.66	.32	4.45	Yellow	P115	L115	115H	1 3/4	3

‡See pages D3.66 – D3.69 for tool and die information.

**Consult cable manufacturer for voltage stress relief instructions with applications greater than 2000 V.

◆NEMA hole sizes and spacing.



Flex Conductor, Two-Hole, Standard Barrel with Window, Narrow Tongue Lug

For Use with Flexible, Extra-Flexible, and Code Stranded Copper Conductors

Type LCDXN

- Narrow tongue width for limited space applications
- Can be used with code conductor and flex conductor class: G, H, I, K, M and Diesel Locomotive
- Generously beveled wire entry prevents bent back strands when inserting conductor into barrel
- Color-coded barrels marked with *PANDUIT* and specified competitor die index numbers for proper crimp die selection
- Inspection window to visually assure full conductor insertion
- Tin-plated to inhibit corrosion
- UL Listed and CSA Certified to 35 KV** and temperature rated to 90°C when crimped with *PANDUIT* and specified competitor crimping tools and dies
- Available with NEMA hole sizes and spacing

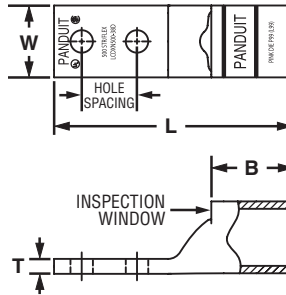

Part Number	Flex Conductor Size		Code Conductor Size	Stud Hole Size (In.)	Stud Hole Spacing (In.)	Figure Dimensions (In.)				PANDUIT Color Code	PANDUIT Die Index No.‡	Burdny Die Index No.‡	T&B Die Index No.‡	Wire Strip Length (In.)	Std. Pkg. Qty.
	Class G, H, I, K, M	Diesel Locomotive				W	B	T	L						
LCDXN2-14A-E*	#2 AWG	#2 AWG	#2 AWG	1/4	.63	.47	.59	.11	2.13	Brown	P33	10	33	11/16	20
LCDXN4/0-38D-X	4/0 AWG	4/0 AWG	4/0 AWG	3/8	1.00	.81	1.03	.16	3.34	Purple	P54	15	54	1 1/16	10
LCDXN350-38D-6	350 kcmil	373.7 kcmil	—	3/8	1.00	1.06	1.29	.22	3.74	Blue	P76	19	76H	1 3/8	6
LCDXN500-38D-6	500 kcmil	535.3 kcmil	—	3/8	1.00	1.30	1.48	.28	4.32	Pink	P99	L99	99H	1 9/16	6
LCDXN750-38D-3	—	777.7 kcmil	—	3/8	1.00	1.50	1.66	.34	4.62	Yellow	P115	L115	115H	1 3/4	3
◆ LCDXN750-12-3	—	777.7 kcmil	—	1/2	1.75	1.50	1.66	.35	5.55	Yellow	P115	L115	115H	1 3/4	3

‡See pages D3.66 – D3.69 for tool and die information.

*Not UL Listed or CSA Certified with Class K flex conductor when crimped with Burdny tools.

**Consult cable manufacturer for voltage stress relief instructions with applications greater than 2000 V.

◆NEMA hole sizes and spacing.

A. System Overview

B1. Cable Ties

B2. Cable Accessories

B3. Stainless Steel Ties

C1. Wiring Duct

C2. Surface Raceway

C3. Abrasion Protection

C4. Cable Management

D1. Terminals

D2. Power Connectors

D3. Grounding Connectors

E1. Labeling Systems

E2. Labels

E3. Pre-Printed & Write-On Markers

E4. Permanent Identification

E5. Lockout/Tagout & Safety Solutions

F. Index

A. System Overview

B1. Cable Ties

B2. Cable Accessories

B3. Stainless Steel Ties

C1. Wiring Duct

C2. Surface Raceway

C3. Abrasion Protection

C4. Cable Management

D1. Terminals

D2. Power Connectors

D3. Grounding Connectors

E1. Labeling Systems

E2. Labels

E3. Pre-Printed & Write-On Markers

E4. Permanent Identification

E5. Lockout/Tagout & Safety Solutions

F. Index



Flex Conductor, Two-Hole, Standard Barrel with Window, Narrow Tongue Lug, 45°

For Use with Flexible Copper Conductors

Type LCDXN-H

- Narrow tongue width for limited space applications
- To be used with Diesel Locomotive flex conductor
- Generously beveled wire entry prevents bent back strands when inserting conductor into barrel
- Color-coded barrels marked with *PANDUIT* and specified competitor die index numbers for proper crimp die selection

- Inspection window to visually assure full conductor insertion
- Tin-plated to inhibit corrosion
- UL Listed and CSA Certified to 35 KV** and temperature rated to 90°C when crimped with *PANDUIT* and specified competitor crimping tools and dies

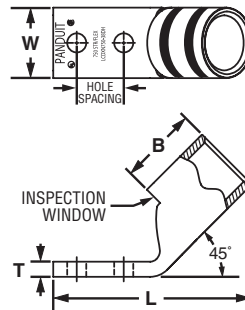

Part Number	Flex Conductor Size		Stud Hole Size (In.)	Stud Hole Spacing (In.)	Figure Dimensions (In.)				PANDUIT Color Code	PANDUIT Die Index No. ‡	Burndy Die Index No. ‡	T&B Die Index No. ‡	Wire Strip Length (In.)	Std. Pkg. Qty.
	Class G, H, I, K, M	Diesel Locomotive			W	B	T	L						
LCDXN750-38DH-3	—	777.7 kcmil	3/8	1.00	1.50	1.66	.35	4.22	Yellow	P115	L115	115H	1 3/4	3

‡See pages D3.66 – D3.69 for tool and die information.

**Consult cable manufacturer for voltage stress relief instructions with applications greater than 2000 V.



Flex Conductor, Two-Hole, Standard Barrel with Window, Narrow Tongue Lug, 90°

For Use with Flexible Copper Conductors

Type LCDXN-F

- Narrow tongue width for limited space applications
- To be used with Diesel Locomotive flex conductor
- Generously beveled wire entry prevents bent back strands when inserting conductor into barrel
- Color-coded barrels marked with *PANDUIT* and specified competitor die index numbers for proper crimp die selection

- Inspection window to visually assure full conductor insertion
- Tin-plated to inhibit corrosion
- UL Listed and CSA Certified to 35 KV** and temperature rated to 90°C when crimped with *PANDUIT* and specified competitor crimping tools and dies

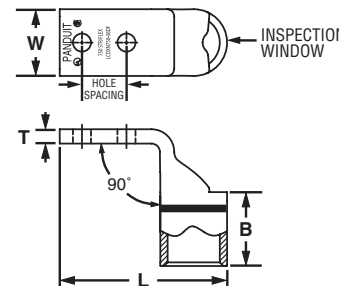

Part Number	Flex Conductor Size		Stud Hole Size (In.)	Stud Hole Spacing (In.)	Figure Dimensions (In.)				PANDUIT Color Code	PANDUIT Die Index No. ‡	Burndy Die Index No.	T&B Die Index No.	Wire Strip Length (In.)	Std. Pkg. Qty.
	Class G, H, I, K, M	Diesel Locomotive			W	B	T	L						
LCDXN750-38DF-3	—	777.7 kcmil	3/8	1.00	1.50	1.66	.35	3.76	Yellow	P115	L115	115H	1 3/4	3

‡See pages D3.66 – D3.69 for tool and die information.

**Consult cable manufacturer for voltage stress relief instructions with applications greater than 2000 V.



Flex Conductor, Two-Hole, Long Barrel with Window Lug

For Use with Flexible, Extra-Flexible, and Code Stranded Copper Conductors

Type LCCX

- Can be used with code conductor and flex conductor class: G, H, I, K, M and Diesel Locomotive
- Long barrel maximizes number of crimps and provides premium wire pull-out strength and electrical performance
- Generously beveled wire entry prevents bent back strands when inserting conductor into barrel
- Color-coded barrels marked with *PANDUIT* and specified competitor die index numbers for proper crimp die selection
- Inspection window to visually assure full conductor insertion
- Tin-plated to inhibit corrosion
- UL Listed and CSA Certified to 35 KV** and temperature rated to 90°C when crimped with *PANDUIT* and specified competitor crimping tools and dies
- Meets J-STD-607-A and TIA-942 requirements for network systems grounding applications
- Available with NEMA hole sizes and spacing

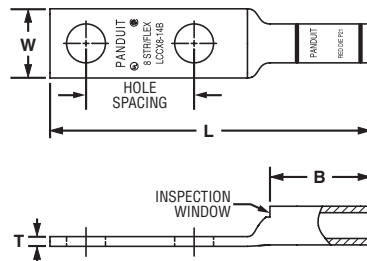

Figure 1

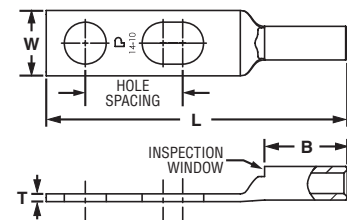

Figure 2: Slotted

Part Number	Flex Conductor Size		Code Conductor Size	Stud Hole Size (In.)	Stud Hole Spacing (In.)	Figure Dimensions (In.)				PANDUIT Color Code	PANDUIT Die Index No.‡	Burndy Die Index No.	T&B Die Index No.	Wire Strip Length (In.)	Std. Pkg. Qty.
	Class G, H, I, K, M	Diesel Locomotive				W	B	T	L						
LCCX8-10A-L	#8 AWG	#8 AWG	#8 AWG	#10	.63	.41	.70	.08	2.01	Red	P21	49	21	3/4	50
LCCX8-10B-L				#10	.75	.41	.70	.08	2.14	Red	P21	49	21	3/4	50
LCCX8-10AB-L*				#10	.63 – .75	.41	.70	.08	2.14	Red	P21	49	21	3/4	50
LCCX8-14A-L				1/4	.63	.48	.70	.07	2.10	Red	P21	49	21	3/4	50
LCCX8-14B-L				1/4	.75	.48	.70	.07	2.23	Red	P21	49	21	3/4	50
LCCX8-14AB-L*				1/4	.63 – .75	.48	.70	.07	2.23	Red	P21	49	21	3/4	50
LCCX8-14D-L				1/4	1.00	.48	.70	.07	2.48	Red	P21	49	21	3/4	50
LCCX8-38D-L				3/8	1.00	.60	.70	.05	2.70	Red	P21	49	21	3/4	50
LCCX6-10B-L	#6 AWG	#6 AWG	#6 AWG	#10	.75	.46	1.07	.08	2.52	Blue	P24	7	24	1 1/8	50
LCCX6-14A-L				1/4	.63	.48	1.07	.08	2.49	Blue	P24	7	24	1 1/8	50
LCCX6-14B-L				1/4	.75	.48	1.07	.08	2.61	Blue	P24	7	24	1 1/8	50
LCCX6-14AB-L*				1/4	.63 – .75	.48	1.07	.08	2.61	Blue	P24	7	24	1 1/8	50
LCCX6-14D-L				1/4	1.00	.48	1.07	.08	2.86	Blue	P24	7	24	1 1/8	50
LCCX6-38A-L				3/8	.63	.62	1.07	.06	2.71	Blue	P24	7	24	1 1/8	50
LCCX6-38C-L				3/8	.88	.62	1.07	.06	2.96	Blue	P24	7	24	1 1/8	50
LCCX6-38AC-L*				3/8	.63 – .88	.62	1.07	.06	2.96	Blue	P24	7	24	1 1/8	50
LCCX6-38D-L	3/8	1.00	.62	1.07	.06	3.08	Blue	P24	7	24	1 1/8	50			
LCCX4-14A-L	#4 AWG	#5, #4, #3 AWG	#4 AWG	1/4	.63	.55	1.05	.09	2.49	Gray	P29	8	29	1 1/8	50
LCCX4-14B-L				1/4	.75	.55	1.05	.09	2.63	Gray	P29	8	29	1 1/8	50
LCCX4-14AB-L*				1/4	.63 – .75	.55	1.05	.09	2.63	Gray	P29	8	29	1 1/8	50
LCCX4-38B-L				3/8	.75	.62	1.05	.08	2.84	Gray	P29	8	29	1 1/8	50
LCCX4-38D-L				3/8	1.00	.62	1.05	.08	3.09	Gray	P29	8	29	1 1/8	50
LCCX4-38BD-L*	3/8	.75 – 1.00	.62	1.05	.08	3.09	Gray	P29	8	29	1 1/8	50			
LCCX2-14A-E*	#2 AWG	#2 AWG	#2 AWG	1/4	.63	.70	1.36	.11	2.89	Brown	P33	10	33	1 7/16	20
LCCX2-14B-E*				1/4	.75	.70	1.36	.11	3.01	Brown	P33	10	33	1 7/16	20
LCCX2-38D-E*				3/8	1.00	.70	1.36	.11	3.46	Brown	P33	10	33	1 7/16	20
LCCX2-12-E*				1/2	1.75	.75	1.36	.09	4.63	Brown	P33	10	33	1 7/16	20

‡See pages D3.66 – D3.69 for tool and die information.

*Not UL Listed or CSA Certified with Class K flex conductor when crimped with Burndy tools.

**Consult cable manufacturer for voltage stress relief instructions with applications greater than 2000 V.

^Slotted lug, refer to Figure 2.

Table continues on page D2.92

A. System Overview

B1. Cable Ties

B2. Cable Accessories

B3. Stainless Steel Ties

C1. Wiring Duct

C2. Surface Raceway

C3. Abrasion Protection

C4. Cable Management

D1. Terminals

D2. Power Connectors

D3. Grounding Connectors

E1. Labeling Systems

E2. Labels

E3. Pre-Printed & Write-On Markers

E4. Permanent Identification

E5. Lockout/Tagout & Safety Solutions

F. Index

A.
System
Overview

B1.
Cable Ties

B2.
Cable
Accessories

B3.
Stainless
Steel Ties

C1.
Wiring
Duct

C2.
Surface
Raceway

C3.
Abrasion
Protection

C4.
Cable
Management

D1.
Terminals

D2.
Power
Connectors

D3.
Grounding
Connectors

E1.
Labeling
Systems

E2.
Labels

E3.
Pre-Printed
& Write-On
Markers

E4.
Permanent
Identification

E5.
Lockout/
Tagout
& Safety
Solutions

F.
Index

UL LISTED US SP CERTIFIED Flex Conductor, Two-Hole, Long Barrel with Window Lug (continued)

Part Number	Flex Conductor Size		Code Conductor Size	Stud Hole Size (In.)	Stud Hole Spacing (In.)	Figure Dimensions (In.)				PANDUIT Color Code	PANDUIT Die Index No.‡	Burndy Die Index No.	T&B Die Index No.	Wire Strip Length (In.)	Std. Pkg. Qty.
	Class G, H, I, K, M	Diesel Locomotive				W	B	T	L						
LCCX1-14A-X	#1 AWG	#1 AWG	#1 AWG	1/4	.63	.76	1.44	.12	3.07	Green	P37	11	37	1 1/2	10
LCCX1-14B-X				1/4	.75	.76	1.44	.12	3.19	Green	P37	11	37	1 1/2	10
LCCX1-14D-X				1/4	1.00	.76	1.44	.12	3.44	Green	P37	11	37	1 1/2	10
LCCX1-56C-X				5/16	.88	.76	1.44	.12	3.37	Green	P37	11	37	1 1/2	10
LCCX1-56D-X				5/16	1.00	.76	1.44	.12	3.50	Green	P37	11	37	1 1/2	10
LCCX1-38D-X				3/8	1.00	.76	1.44	.12	3.57	Green	P37	11	37	1 1/2	10
LCCX1/0-14A-X	1/0 AWG	1/0 AWG	1/0 AWG	1/4	.63	.85	1.50	.13	3.23	Pink	P42	12	42	1 9/16	10
LCCX1/0-14B-X				1/4	.75	.85	1.50	.13	3.36	Pink	P42	12	42	1 9/16	10
LCCX1/0-38D-X				3/8	1.00	.85	1.50	.13	3.67	Pink	P42	12	42	1 9/16	10
LCCX1/0-12-X				1/2	1.75	.85	1.50	.13	4.83	Pink	P42	12	42	1 9/16	10
LCCX2/0-14A-X	2/0 AWG	2/0 AWG	2/0 AWG	1/4	.63	.96	1.50	.13	3.27	Black	P45	13	45	1 9/16	10
LCCX2/0-14B-X				1/4	.75	.96	1.50	.13	3.39	Black	P45	13	45	1 9/16	10
LCCX2/0-38D-X				3/8	1.00	.96	1.50	.13	3.70	Black	P45	13	45	1 9/16	10
LCCX2/0-12-X				1/2	1.75	.96	1.50	.13	4.87	Black	P45	13	45	1 9/16	10
LCCX3/0-14B-X	3/0 AWG	3/0 AWG	3/0 AWG	1/4	.75	1.06	1.56	.14	3.48	Orange	P50	14	50	1 5/8	10
LCCX3/0-38D-X				3/8	1.00	1.06	1.56	.14	3.81	Orange	P50	14	50	1 5/8	10
LCCX4/0-14B-X	4/0 AWG	4/0 AWG	4/0 AWG	1/4	.75	1.19	2.24	.16	4.07	Purple	P54	15	54	2 5/16	10
LCCX4/0-38D-X				3/8	1.00	1.19	2.24	.16	4.55	Purple	P54	15	54	2 5/16	10
LCCX4/0-12-X				1/2	1.75	1.19	2.24	.16	5.73	Purple	P54	15	54	2 5/16	10
LCCX250-14B-X	250 kcmil	262.6 kcmil	—	1/4	.75	1.28	2.24	.17	4.11	Yellow	P62	16	62	2 5/16	10
LCCX250-38D-X				3/8	1.00	1.28	2.24	.17	4.59	Yellow	P62	16	62	2 5/16	10
LCCX300-38D-6	300 kcmil	313.1 kcmil	—	3/8	1.00	1.39	2.30	.18	4.67	Red	P71	18	71H	2 3/8	6
LCCX350-14B-6	350 kcmil	373.7 kcmil	—	1/4	.75	1.54	2.50	.22	4.47	Blue	P76	19	76H	2 9/16	6
LCCX350-38D-6				3/8	1.00	1.54	2.50	.22	4.95	Blue	P76	19	76H	2 9/16	6
LCCX350-12-6				1/2	1.75	1.54	2.50	.22	6.13	Blue	P76	19	76H	2 9/16	6
LCCX500-12-6	500 kcmil	535.3 kcmil	—	1/2	1.75	1.89	2.88	.26	6.66	Pink	P99	L99	99H	2 15/16	6

‡See pages D3.66 – D3.69 for tool and die information.

**Consult cable manufacturer for voltage stress relief instructions with applications greater than 2000 V.

◆NEMA hole sizes and spacing.



Flex Conductor, Two-Hole, Long Barrel with Window Lug, 45° Angle

For Use with Flexible, Extra-Flexible, and Code Stranded Copper Conductors

Type LCCX-H

- Can be used with code conductor and flex conductor class: G, H, I, K, M and Diesel Locomotive
- Long barrel maximizes number of crimps and provides premium wire pull-out strength and electrical performance
- Generously beveled wire entry prevents bent back strands when inserting conductor into barrel
- Color-coded barrels marked with *PANDUIT* and specified competitor die index numbers for proper crimp die selection
- Inspection window to visually assure full conductor insertion
- Tin-plated to inhibit corrosion
- UL Listed and CSA Certified to 35 KV** and temperature rated to 90°C when crimped with *PANDUIT* and specified competitor crimping tools and dies
- Meets J-STD-607-A and TIA-942 requirements for network systems grounding applications
- Available with NEMA hole sizes and spacing

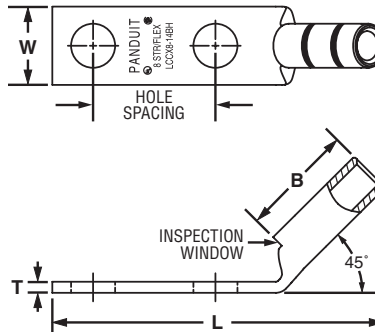

Part Number	Flex Conductor Size		Code Conductor Size	Stud Hole Size (In.)	Stud Hole Spacing (In.)	Figure Dimensions (In.)				PANDUIT Color Code	PANDUIT Die Index No.‡	Burndy Die Index No.‡	T&B Die Index No.‡	Wire Strip Length (In.)	Std. Pkg. Qty.
	Class G, H, I, K, M	Diesel Locomotive				W	B	T	L						
LCCX8-10AH-L	#8 AWG	#8 AWG	#8 AWG	#10	.63	.41	.70	.08	1.82	Red	P21	49	21	3/4	50
LCCX8-10BH-L				#10	.75	.41	.70	.08	1.95	Red	P21	49	21	3/4	50
LCCX8-14AH-L				1/4	.63	.48	.70	.07	1.91	Red	P21	49	21	3/4	50
LCCX8-14BH-L				1/4	.75	.48	.70	.07	2.03	Red	P21	49	21	3/4	50
LCCX8-14DH-L				1/4	1.00	.48	.70	.07	2.28	Red	P21	49	21	3/4	50
LCCX8-38DH-L				3/8	1.00	.60	.70	.05	2.49	Red	P21	49	21	3/4	50
LCCX6-10BH-L	#6 AWG	#6 AWG	#6 AWG	#10	.75	.46	1.07	.08	2.22	Blue	P24	7	24	1 1/8	50
LCCX6-14AH-L				1/4	.63	.48	1.07	.08	2.18	Blue	P24	7	24	1 1/8	50
LCCX6-14BH-L				1/4	.75	.48	1.07	.08	2.31	Blue	P24	7	24	1 1/8	50
LCCX6-14DH-L				1/4	1.00	.48	1.07	.08	2.56	Blue	P24	7	24	1 1/8	50
LCCX6-38AH-L				3/8	.63	.62	1.07	.06	2.39	Blue	P24	7	24	1 1/8	50
LCCX6-38CH-L				3/8	.88	.62	1.07	.06	2.64	Blue	P24	7	24	1 1/8	50
LCCX6-38DH-L	3/8	1.00	.62	1.07	.06	2.77	Blue	P24	7	24	1 1/8	50			
LCCX4-14AH-L	#4 AWG	#5, #4, #3 AWG	#4 AWG	1/4	.63	.55	1.05	.09	2.20	Gray	P29	8	29	1 1/8	50
LCCX4-14BH-L				1/4	.75	.55	1.05	.09	2.32	Gray	P29	8	29	1 1/8	50
LCCX4-38BH-L				3/8	.75	.62	1.05	.08	2.54	Gray	P29	8	29	1 1/8	50
LCCX4-38DH-L				3/8	1.00	.62	1.05	.08	2.79	Gray	P29	8	29	1 1/8	20
LCCX2-14AH-E*	#2 AWG	#2 AWG	#2 AWG	1/4	.63	.70	1.36	.11	2.46	Brown	P33	10	33	1 7/16	20
LCCX2-14BH-E*				1/4	.75	.70	1.36	.11	2.58	Brown	P33	10	33	1 7/16	20
LCCX2-38DH-E*				3/8	1.00	.70	1.36	.11	3.04	Brown	P33	10	33	1 7/16	20
LCCX2-12H-E*				1/2	1.75	.75	1.36	.09	4.20	Brown	P33	10	33	1 7/16	10
LCCX1-14AH-X	#1 AWG	#1 AWG	#1 AWG	1/4	.63	.76	1.44	.12	2.61	Green	P37	11	37	1 1/2	10
LCCX1-14BH-X				1/4	.75	.76	1.44	.12	2.73	Green	P37	11	37	1 1/2	10
LCCX1-14DH-X				1/4	1.00	.76	1.44	.12	2.98	Green	P37	11	37	1 1/2	10
LCCX1-56CH-X				5/16	.88	.76	1.44	.12	2.91	Green	P37	11	37	1 1/2	10
LCCX1-56DH-X				5/16	1.00	.76	1.44	.12	3.04	Green	P37	11	37	1 1/2	10
LCCX1-38DH-X				3/8	1.00	.76	1.44	.12	3.11	Green	P37	11	37	1 1/2	10

‡See pages D3.66 – D3.69 for tool and die information.

*Not UL Listed or CSA Certified with Class K flex conductor when crimped with Burndy tools.

**Consult cable manufacturer for voltage stress relief instructions with applications greater than 2000 V.

Table continues on page D2.94

A. System Overview

B1. Cable Ties

B2. Cable Accessories

B3. Stainless Steel Ties

C1. Wiring Duct

C2. Surface Raceway

C3. Abrasion Protection

C4. Cable Management

D1. Terminals

D2. Power Connectors

D3. Grounding Connectors

E1. Labeling Systems

E2. Labels

E3. Pre-Printed & Write-On Markers

E4. Permanent Identification

E5. Lockout/Tagout & Safety Solutions

F. Index

A.
System
Overview

B1.
Cable Ties

B2.
Cable
Accessories

B3.
Stainless
Steel Ties

C1.
Wiring
Duct

C2.
Surface
Raceway

C3.
Abrasion
Protection

C4.
Cable
Management

D1.
Terminals

D2.
Power
Connectors

D3.
Grounding
Connectors

E1.
Labeling
Systems

E2.
Labels

E3.
Pre-Printed
& Write-On
Markers

E4.
Permanent
Identification

E5.
Lockout/
Tagout
& Safety
Solutions

F.
Index



Flex Conductor, Two-Hole, Long Barrel with Window Lug, 45° Angle (continued)

Part Number	Flex Conductor Size		Code Conductor Size	Stud Hole Size (In.)	Stud Hole Spacing (In.)	Figure Dimensions (In.)				PANDUIT Color Code	PANDUIT Die Index No.‡	Burndy Die Index No.‡	T&B Die Index No.‡	Wire Strip Length (In.)	Std. Pkg. Qty.
	Class G, H, I, K, M	Diesel Locomotive				W	B	T	L						
LCCX1/0-14AH-X	1/0 AWG	1/0 AWG	1/0 AWG	1/4	.63	.85	1.50	.13	2.76	Pink	P42	12	42	1 9/16	10
LCCX1/0-14BH-X				1/4	.75	.85	1.50	.13	2.88	Pink	P42	12	42	1 9/16	10
LCCX1/0-38DH-X				3/8	1.00	.85	1.50	.13	3.20	Pink	P42	12	42	1 9/16	10
LCCX1/0-12H-X				1/2	1.75	.85	1.50	.13	4.36	Pink	P42	12	42	1 9/16	10
LCCX2/0-14AH-X	2/0 AWG	2/0 AWG	2/0 AWG	1/4	.63	.96	1.50	.13	2.78	Black	P45	13	45	1 9/16	10
LCCX2/0-14BH-X				1/4	.75	.96	1.50	.13	2.91	Black	P45	13	45	1 9/16	10
LCCX2/0-38DH-X				3/8	1.00	.96	1.50	.13	3.22	Black	P45	13	45	1 9/16	10
LCCX2/0-12H-X				1/2	1.75	.96	1.50	.13	4.38	Black	P45	13	45	1 9/16	10
LCCX3/0-14BH-X	3/0 AWG	3/0 AWG	3/0 AWG	1/4	.75	1.06	1.56	.14	2.98	Orange	P50	14	50	1 5/8	10
LCCX3/0-38DH-X				3/8	1.00	1.06	1.56	.14	3.31	Orange	P50	14	50	1 5/8	10
LCCX4/0-14BH-X	4/0 AWG	4/0 AWG	4/0 AWG	1/4	.75	1.19	2.24	.16	3.45	Purple	P54	15	54	2 5/16	10
LCCX4/0-38DH-X				3/8	1.00	1.19	2.24	.16	3.93	Purple	P54	15	54	2 5/16	10
LCCX4/0-12H-X				1/2	1.75	1.19	2.24	.16	5.11	Purple	P54	15	54	2 5/16	10
LCCX250-14BH-X	250 kcmil	262.6 kcmil	—	1/4	.75	1.28	2.24	.17	3.48	Yellow	P62	16	62	2 5/16	10
LCCX250-38DH-X				3/8	1.00	1.28	2.24	.17	3.96	Yellow	P62	16	62	2 5/16	6
LCCX300-38DH-6	300 kcmil	313.1 kcmil	—	3/8	1.00	1.39	2.30	.18	4.07	Red	P71	18	71H	2 3/8	6
LCCX350-14BH-6	350 kcmil	373.7 kcmil	—	1/4	.75	1.54	2.50	.22	3.81	Blue	P76	19	76H	2 9/16	6
LCCX350-38DH-6				3/8	1.00	1.54	2.50	.22	4.29	Blue	P76	19	76H	2 9/16	6
LCCX350-12H-6				1/2	1.75	1.54	2.50	.22	5.47	Blue	P76	19	76H	2 9/16	6

‡See pages D3.66 – D3.69 for tool and die information.

**Consult cable manufacturer for voltage stress relief instructions with applications greater than 2000 V.

◆NEMA hole sizes and spacing.



Flex Conductor, Two-Hole, Long Barrel with Window Lug, 90° Angle

For Use with Flexible, Extra-Flexible, and Code Stranded Copper Conductors

Type LCCX-F

- Can be used with code conductor and flex conductor class: G, H, I, K, M and Diesel Locomotive
- Long barrel maximizes number of crimps and provides premium wire pull-out strength and electrical performance
- Generously beveled wire entry prevents bent back strands when inserting conductor into barrel
- Color-coded barrels marked with *PANDUIT* and specified competitor die index numbers for proper crimp die selection
- Inspection window to visually assure full conductor insertion
- Tin-plated to inhibit corrosion
- UL Listed and CSA Certified to 35 KV** and temperature rated to 90°C when crimped with *PANDUIT* and specified competitor crimping tools and dies
- Meets J-STD-607-A and TIA-942 requirements for network systems grounding applications
- Available with NEMA hole sizes and spacing

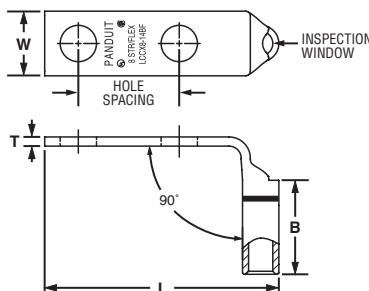

Part Number	Flex Conductor Size		Code Conductor Size	Stud Hole Size (In.)	Stud Hole Spacing (In.)	Figure Dimensions (In.)				PANDUIT Color Code	PANDUIT Die Index No.‡	Burndy Die Index No.	T&B Die Index No.	Wire Strip Length (In.)	Std. Pkg. Qty.
	Class G, H, I, K, M	Diesel Locomotive				W	B	T	L						
LCCX8-10AF-L	#8 AWG	#8 AWG	#8 AWG	#10	.63	.41	.70	.08	1.53	Red	P21	49	21	3/4	50
LCCX8-10BF-L				#10	.75	.41	.70	.08	1.65	Red	P21	49	21	3/4	50
LCCX8-14AF-L				1/4	.63	.48	.70	.07	1.62	Red	P21	49	21	3/4	50
LCCX8-14BF-L				1/4	.75	.48	.70	.07	1.74	Red	P21	49	21	3/4	50
LCCX8-14DF-L				1/4	1.00	.48	.70	.07	1.99	Red	P21	49	21	3/4	50
LCCX8-38DF-L				3/8	1.00	.60	.70	.05	2.21	Red	P21	49	21	3/4	50
LCCX6-10BF-L	#6 AWG	#6 AWG	#6 AWG	#10	.75	.46	1.07	.08	1.69	Blue	P24	7	24	1 1/8	50
LCCX6-14AF-L				1/4	.63	.48	1.07	.08	1.66	Blue	P24	7	24	1 1/8	50
LCCX6-14BF-L				1/4	.75	.48	1.07	.08	1.78	Blue	P24	7	24	1 1/8	50
LCCX6-14DF-L				1/4	1.00	.48	1.07	.08	2.03	Blue	P24	7	24	1 1/8	50
LCCX6-38AF-L				3/8	.63	.62	1.07	.06	1.88	Blue	P24	7	24	1 1/8	50
LCCX6-38CF-L				3/8	.88	.62	1.07	.06	2.13	Blue	P24	7	24	1 1/8	50
LCCX6-38DF-L	3/8	1.00	.62	1.07	.06	2.25	Blue	P24	7	24	1 1/8	50			
LCCX4-14AF-L	#4 AWG	#5, #4, #3 AWG	#4 AWG	1/4	.63	.55	1.05	.09	1.74	Gray	P29	8	29	1 1/8	50
LCCX4-14BF-L				1/4	.75	.55	1.05	.09	1.87	Gray	P29	8	29	1 1/8	50
LCCX4-38BF-L				3/8	.75	.62	1.05	.08	2.09	Gray	P29	8	29	1 1/8	50
LCCX4-38DF-L				3/8	1.00	.62	1.05	.08	2.34	Gray	P29	8	29	1 1/8	50
LCCX2-14AF-E*	#2 AWG	#2 AWG	#2 AWG	1/4	.63	.70	1.36	.11	1.94	Brown	P33	10	33	1 7/16	20
LCCX2-14BF-E*				1/4	.75	.70	1.36	.11	2.06	Brown	P33	10	33	1 7/16	20
LCCX2-38DF-E*				3/8	1.00	.70	1.36	.11	2.51	Brown	P33	10	33	1 7/16	20
LCCX2-12F-E*				1/2	1.75	.75	1.36	.09	3.68	Brown	P33	10	33	1 7/16	20
LCCX1-14AF-X	#1 AWG	#1 AWG	#1 AWG	1/4	.63	.76	1.44	.12	2.08	Green	P37	11	37	1 1/2	10
LCCX1-14BF-X				1/4	.75	.76	1.44	.12	2.20	Green	P37	11	37	1 1/2	10
LCCX1-14DF-X				1/4	1.00	.76	1.44	.12	2.45	Green	P37	11	37	1 1/2	10
LCCX1-56CF-X				5/16	.88	.76	1.44	.12	2.38	Green	P37	11	37	1 1/2	10
LCCX1-56DF-X				5/16	1.00	.76	1.44	.12	2.51	Green	P37	11	37	1 1/2	10
LCCX1-38DF-X				3/8	1.00	.76	1.44	.12	2.58	Green	P37	11	37	1 1/2	10
LCCX1/0-14AF-X	1/0 AWG	1/0 AWG	1/0 AWG	1/4	.63	.85	1.50	.13	2.22	Pink	P42	12	42	1 9/16	10
LCCX1/0-14BF-X				1/4	.75	.85	1.50	.13	2.34	Pink	P42	12	42	1 9/16	10
LCCX1/0-38DF-X				3/8	1.00	.85	1.50	.13	2.66	Pink	P42	12	42	1 9/16	10
LCCX1/0-12F-X				1/2	1.75	.85	1.50	.13	3.82	Pink	P42	12	42	1 9/16	10

‡See pages D3.66 – D3.69 for tool and die information.

*Not UL Listed or CSA Certified with Class K flex conductor when crimped with Burndy tools.

**Consult cable manufacturer for voltage stress relief instructions with applications greater than 2000 V.

Table continues on page D2.96

A. System Overview

B1. Cable Ties

B2. Cable Accessories

B3. Stainless Steel Ties

C1. Wiring Duct

C2. Surface Raceway

C3. Abrasion Protection

C4. Cable Management

D1. Terminals

D2. Power Connectors

D3. Grounding Connectors

E1. Labeling Systems

E2. Labels

E3. Pre-Printed & Write-On Markers

E4. Permanent Identification

E5. Lockout/Tagout & Safety Solutions

F. Index

A.
System
Overview

B1.
Cable Ties

B2.
Cable
Accessories

B3.
Stainless
Steel Ties

C1.
Wiring
Duct

C2.
Surface
Raceway

C3.
Abrasion
Protection

C4.
Cable
Management

D1.
Terminals

D2.
Power
Connectors

D3.
Grounding
Connectors

E1.
Labeling
Systems

E2.
Labels

E3.
Pre-Printed
& Write-On
Markers

E4.
Permanent
Identification

E5.
Lockout/
Tagout/
& Safety
Solutions

F.
Index

  **Flex Conductor, Two-Hole, Long Barrel with Window Lug, 90° Angle (continued)**

Part Number	Flex Conductor Size		Code Conductor Size	Stud Hole Size (In.)	Stud Hole Spacing (In.)	Figure Dimensions (In.)				PANDUIT Color Code	PANDUIT Die Index No.‡	Burndy Die Index No.	T&B Die Index No.	Wire Strip Length (In.)	Std. Pkg. Qty.
	Class G, H, I, K, M	Diesel Locomotive				W	B	T	L						
LCCX2/0-14AF-X	2/0 AWG	2/0 AWG	2/0 AWG	1/4	.63	.96	1.50	.13	2.29	Black	P45	13	45	1 9/16	10
LCCX2/0-14BF-X				1/4	.75	.96	1.50	.13	2.42	Black	P45	13	45	1 9/16	10
LCCX2/0-38DF-X				3/8	1.00	.96	1.50	.13	2.73	Black	P45	13	45	1 9/16	10
LCCX2/0-12F-X				1/2	1.75	.96	1.50	.13	3.89	Black	P45	13	45	1 9/16	10
LCCX3/0-14BF-X	3/0 AWG	3/0 AWG	3/0 AWG	1/4	.75	1.06	1.56	.14	2.50	Orange	P50	14	50	1 5/8	10
LCCX3/0-38DF-X				3/8	1.00	1.06	1.56	.14	2.84	Orange	P50	14	50	1 5/8	10
LCCX4/0-14BF-X	4/0 AWG	4/0 AWG	4/0 AWG	1/4	.75	1.19	2.24	.16	2.69	Purple	P54	15	54	2 5/16	10
LCCX4/0-38DF-X				3/8	1.00	1.19	2.24	.16	2.88	Purple	P54	15	54	2 5/16	10
LCCX4/0-12F-X				1/2	1.75	1.19	2.24	.16	4.06	Purple	P54	15	54	2 5/16	10
LCCX250-14BF-X	250 kcmil	262.6 kcmil	—	1/4	.75	1.28	2.24	.17	2.46	Yellow	P62	16	62	2 5/16	10
LCCX250-38DF-X				3/8	1.00	1.28	2.24	.17	2.94	Yellow	P62	16	62	2 5/16	10
LCCX300-38DF-6	300 kcmil	313.1 kcmil	—	3/8	1.00	1.39	2.30	.18	3.02	Red	P71	18	71H	2 3/8	6
LCCX350-14BF-6	350 kcmil	373.7 kcmil	—	1/4	.75	1.54	2.50	.22	2.65	Blue	P76	19	76H	2 9/16	6
LCCX350-38DF-6				3/8	1.00	1.54	2.50	.22	3.13	Blue	P76	19	76H	2 9/16	6
LCCX350-12F-6				1/2	1.75	1.54	2.50	.22	4.31	Blue	P76	19	76H	2 9/16	6

‡See pages D3.66 – D3.69 for tool and die information.

**Consult cable manufacturer for voltage stress relief instructions with applications greater than 2000 V.

◆NEMA hole sizes and spacing.



Flex Conductor, Two-Hole, Long Barrel, Flared NEBS Lug

For Use with Flexible and Extra-Flexible Copper Conductors

Type LCCF

- Can be used with flex conductor class: K, M, and Diesel Locomotive
- Long barrel maximizes the number of crimps and provides premium wire pull-out strength and electrical performance
- Flared entry prevents bent back strands when inserting fine strand conductor into barrel
- Color-coded barrels marked with *PANDUIT* die index numbers for proper crimp die selection
- Enclosed barrel prevents corrosive material from entering barrel when used in harsh environments
- Tin-plated to inhibit corrosion
- UL Listed and CSA Certified to 35 KV** and temperature rated to 90°C when crimped with *PANDUIT* crimping tools and dies
- **Tested by Telcordia – meets NEBS Level 3**
- Available with NEMA hole sizes and spacing

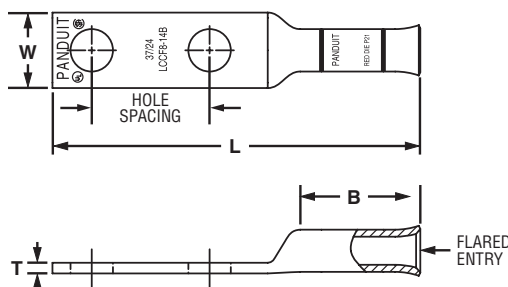

Part Number	Flex Conductor Size		Stud Hole Size (In.)	Stud Hole Spacing (In.)	Figure Dimensions (In.)				PANDUIT Color Code	PANDUIT Die Index No.‡	Wire Strip Length (In.)	Std. Pkg. Qty.
	Class K and M	Diesel Locomotive			W	B	T	L				
LCCF8-14A-L	—	#8 AWG	1/4	.63	.48	.76	.07	2.22	Red	P21	13/16	50
LCCF8-14B-L			1/4	.75	.48	.76	.07	2.34	Red	P21	13/16	50
LCCF8-38D-L			3/8	1.00	.60	.76	.05	2.81	Red	P21	13/16	50
LCCF6-14A-L	#6 AWG	#6 AWG	1/4	.63	.48	1.22	.08	2.71	Blue	P24	1 5/16	50
LCCF6-14B-L			1/4	.75	.48	1.22	.08	2.83	Blue	P24	1 5/16	50
LCCF6-38D-L			3/8	1.00	.62	1.22	.06	3.30	Blue	P24	1 5/16	50
LCCF4-14A-L	#4 AWG	#4 AWG	1/4	.63	.55	1.23	.09	2.75	Gray	P29	1 5/16	50
LCCF4-14B-L			1/4	.75	.55	1.23	.09	2.88	Gray	P29	1 5/16	50
LCCF4-38D-L			3/8	1.00	.62	1.23	.08	3.35	Gray	P29	1 5/16	50
LCCF2-14A-E	#2 AWG	#2 AWG	1/4	.63	.70	1.36	.11	3.00	Brown	P33	1 7/16	20
LCCF2-14B-E			1/4	.75	.70	1.36	.11	3.12	Brown	P33	1 7/16	20
LCCF2-56B-E			5/16	.75	.70	1.36	.11	3.25	Brown	P33	1 7/16	20
LCCF2-38D-E			3/8	1.00	.70	1.36	.11	3.57	Brown	P33	1 7/16	20
LCCF2-12-E			1/2	1.75	.75	1.36	.09	4.74	Brown	P33	1 7/16	20
LCCF1-14A-X	#1 AWG	#1 AWG	1/4	.63	.76	1.44	.12	3.18	Pink	P42	1 1/2	10
LCCF1-14B-X			1/4	.75	.76	1.44	.12	3.31	Pink	P42	1 1/2	10
LCCF1-56C-X			5/16	.88	.76	1.44	.12	3.49	Pink	P42	1 1/2	10
LCCF1-38D-X			3/8	1.00	.76	1.44	.12	3.69	Pink	P42	1 1/2	10
LCCF1-12-X			1/2	1.75	.80	1.44	.12	4.86	Pink	P42	1 1/2	10

‡See pages D3.70, D3.71 for tool and die information.

**Consult cable manufacturer for voltage stress relief instructions with applications greater than 2000 V.

◆NEMA hole sizes and spacing.

Table continues on page D2.98

A. System Overview

B1. Cable Ties

B2. Cable Accessories

B3. Stainless Steel Ties

C1. Wiring Duct

C2. Surface Raceway

C3. Abrasion Protection

C4. Cable Management

D1. Terminals

D2. Power Connectors

D3. Grounding Connectors

E1. Labeling Systems

E2. Labels

E3. Pre-Printed & Write-On Markers

E4. Permanent Identification

E5. Lockout/Tagout & Safety Solutions

F. Index

A. System Overview

B1. Cable Ties

B2. Cable Accessories

B3. Stainless Steel Ties

C1. Wiring Duct

C2. Surface Raceway

C3. Abrasion Protection

C4. Cable Management

D1. Terminals

D2. Power Connectors

D3. Grounding Connectors

E1. Labeling Systems

E2. Labels

E3. Pre-Printed & Write-On Markers

E4. Permanent Identification

E5. Lockout/Tagout & Safety Solutions

F. Index



Flex Conductor, Two-Hole, Long Barrel, Flared NEBS Lug (continued)

Part Number	Flex Conductor Size		Stud Hole Size (In.)	Stud Hole Spacing (In.)	Figure Dimensions (In.)				PANDUIT Color Code	PANDUIT Die Index No.‡	Wire Strip Length (In.)	Std. Pkg. Qty.
	Class K and M	Diesel Locomotive			W	B	T	L				
LCCF1/0-14A-X	1/0 AWG	1/0 AWG	1/4	.63	.85	1.50	.13	3.38	Black	P45	1 9/16	10
LCCF1/0-14B-X			1/4	.75	.85	1.50	.13	3.51	Black	P45	1 9/16	10
LCCF1/0-56C-X			5/16	.88	.85	1.50	.13	3.63	Black	P45	1 9/16	10
LCCF1/0-38D-X			3/8	1.00	.85	1.50	.13	3.82	Black	P45	1 9/16	10
LCCF1/0-12-X	2/0 AWG	2/0 AWG	1/2	1.75	.85	1.50	.13	4.98	Black	P45	1 9/16	10
LCCF2/0-14A-X			1/4	.63	.96	1.50	.13	3.43	Orange	P50	1 9/16	10
LCCF2/0-14B-X			1/4	.75	.96	1.50	.13	3.56	Orange	P50	1 9/16	10
LCCF2/0-38D-X			3/8	1.00	.96	1.50	.13	3.87	Orange	P50	1 9/16	10
LCCF2/0-12-X	3/0 AWG	3/0 AWG	1/2	1.75	.96	1.50	.13	5.03	Orange	P50	1 9/16	10
LCCF3/0-14B-X			1/4	.75	1.06	1.56	.14	3.66	Purple	P54	1 5/8	10
LCCF3/0-38D-X			3/8	1.00	1.06	1.56	.14	3.99	Purple	P54	1 5/8	10
LCCF3/0-12-X			1/2	1.75	1.06	1.56	.14	5.13	Purple	P54	1 5/8	10
LCCF4/0-14B-X	4/0 AWG	4/0 AWG	1/4	.75	1.17	1.61	.14	3.60	Yellow	P62	1 11/16	10
LCCF4/0-38D-X			3/8	1.00	1.17	1.61	.14	4.09	Yellow	P62	1 11/16	10
LCCF4/0-38-X			3/8	1.75	1.17	1.61	.14	4.84	Yellow	P62	1 11/16	10
LCCF4/0-12-X			1/2	1.75	1.17	1.61	.14	5.23	Yellow	P62	1 11/16	10
LCCF250-14B-X	250 kcmil	262.6 kcmil	1/4	.75	1.28	2.24	.17	4.33	White	P66	2 5/16	10
LCCF250-38D-X			3/8	1.00	1.28	2.24	.17	4.81	White	P66	2 5/16	10
LCCF250-12E-X			1/2	1.25	1.28	2.24	.17	5.49	White	P66	2 5/16	10
LCCF250-12-X			1/2	1.75	1.28	2.24	.17	5.99	White	P66	2 5/16	10
LCCF300-14B-6	300 kcmil	313.1 kcmil	1/4	.75	1.38	2.30	.18	4.44	Red	P71	2 3/8	6
LCCF300-38D-6			3/8	1.00	1.38	2.30	.18	4.92	Red	P71	2 3/8	6
LCCF300-12-6			1/2	1.75	1.38	2.30	.18	6.10	Red	P71	2 3/8	6
LCCF350-14B-6			350 kcmil	373.7 kcmil	1/4	.75	1.53	2.50	.22	4.70	Blue	P76
LCCF350-38D-6	3/8	1.00			1.53	2.50	.22	5.18	Blue	P76	2 9/16	6
LCCF350-12E-6	1/2	1.25			1.53	2.50	.22	5.86	Blue	P76	2 9/16	6
LCCF350-12-6	1/2	1.75			1.53	2.50	.22	6.36	Blue	P76	2 9/16	6
LCCF400-38D-6	400 kcmil	444.4 kcmil	3/8	1.00	1.70	2.69	.26	5.45	Brown	P87	2 3/4	6
LCCF400-12-6			1/2	1.75	1.70	2.69	.26	6.63	Brown	P87	2 3/4	6
LCCF500-12-6			1/2	1.75	1.89	2.88	.26	7.04	Pink	P99	2 15/16	6
LCCF600-12-6			—	646.4 kcmil	1/2	1.75	1.95	2.94	.29	7.13	Black	P106
LCCF750-38D-3	—	777.7 kcmil	3/8	1.00	2.17	3.00	.32	6.35	Orange	P107	3 1/16	3
LCCF750-12-3			1/2	1.75	2.17	3.00	.32	7.29	Orange	P107	3 1/16	3

‡See pages D3.70, D3.71 for tool and die information.

**Consult cable manufacturer for voltage stress relief instructions with applications greater than 2000 V.

◆NEMA hole sizes and spacing.



Flex Conductor, Two-Hole, Long Barrel, Flared NEBS Lug, 45° Angle

For Use with Flexible and Extra-Flexible Copper Conductors

Type LCCF-H

- Can be used with flex conductor class: K, M, and Diesel Locomotive
- Long barrel maximizes the number of crimps and provides premium wire pull-out strength and electrical performance
- Flared entry prevents bent back strands when inserting fine strand conductor into barrel
- Color-coded barrels marked with *PANDUIT* die index numbers for proper crimp die selection
- Enclosed barrel prevents corrosive material from entering barrel when used in harsh environments
- Tin-plated to inhibit corrosion
- UL Listed and CSA Certified to 35 KV** and temperature rated to 90°C when crimped with *PANDUIT* crimping tools and dies
- **Tested by Telcordia – meets NEBS Level 3**
- Available with NEMA hole sizes and spacing

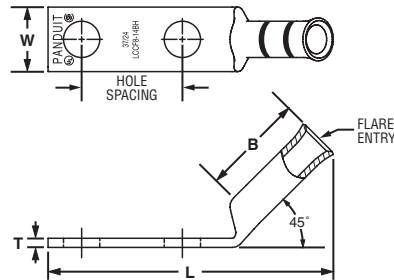

A. System Overview

B1. Cable Ties

B2. Cable Accessories

B3. Stainless Steel Ties

C1. Wiring Duct

C2. Surface Raceway

C3. Abrasion Protection

C4. Cable Management

D1. Terminals

D2. Power Connectors

D3. Grounding Connectors

E1. Labeling Systems

E2. Labels

E3. Pre-Printed & Write-On Markers

E4. Permanent Identification

E5. Lockout/Tagout & Safety Solutions

F. Index

Part Number	Flex Conductor Size		Stud Hole Size (In.)	Stud Hole Spacing (In.)	Figure Dimensions (In.)				PANDUIT Color Code	PANDUIT Die Index No.‡	Wire Strip Length (In.)	Std. Pkg. Qty.
	Class K and M	Diesel Locomotive			W	B	T	L				
LCCF8-14AH-L	—	#8 AWG	1/4	.63	.48	.76	.07	2.00	Red	P21	13/16	50
LCCF8-14BH-L			1/4	.75	.48	.76	.07	2.12	Red	P21	13/16	50
LCCF8-38DH-L			3/8	1.00	.60	.76	.05	2.58	Red	P21	13/16	50
LCCF6-14AH-L	#6 AWG	#6 AWG	1/4	.63	.48	1.22	.08	2.36	Blue	P24	1 5/16	50
LCCF6-14BH-L			1/4	.75	.48	1.22	.08	2.48	Blue	P24	1 5/16	50
LCCF6-38DH-L			3/8	1.00	.62	1.22	.06	2.94	Blue	P24	1 5/16	50
LCCF4-14AH-L	#4 AWG	#4 AWG	1/4	.63	.55	1.23	.09	2.41	Gray	P29	1 5/16	50
LCCF4-14BH-L			1/4	.75	.55	1.23	.09	2.54	Gray	P29	1 5/16	50
LCCF4-38DH-L			3/8	1.00	.62	1.23	.08	3.00	Gray	P29	1 5/16	50
LCCF2-14AH-E	#2 AWG	#2 AWG	1/4	.63	.70	1.36	.11	2.56	Brown	P33	1 7/16	20
LCCF2-14BH-E			1/4	.75	.70	1.36	.11	2.68	Brown	P33	1 7/16	20
LCCF2-56BH-E			5/16	.75	.70	1.36	.11	2.81	Brown	P33	1 7/16	20
LCCF2-38DH-E	#1 AWG	#1 AWG	3/8	1.00	.70	1.36	.11	3.13	Brown	P33	1 7/16	20
LCCF2-12H-E			1/2	1.75	.75	1.36	.09	4.30	Brown	P33	1 7/16	20
LCCF1-14AH-X			1/4	.63	.76	1.44	.12	2.71	Pink	P42	1 1/2	10
LCCF1-14BH-X	#1 AWG	#1 AWG	1/4	.75	.76	1.44	.12	2.84	Pink	P42	1 1/2	10
LCCF1-56CH-X			5/16	.88	.76	1.44	.12	3.02	Pink	P42	1 1/2	10
LCCF1-38DH-X			3/8	1.00	.76	1.44	.12	3.22	Pink	P42	1 1/2	10
LCCF1-12H-X	1/0 AWG	1/0 AWG	1/2	1.75	.80	1.44	.12	4.38	Pink	P42	1 1/2	10
LCCF1/0-14AH-X			1/4	.63	.85	1.50	.13	2.90	Black	P45	1 9/16	10
LCCF1/0-14BH-X			1/4	.75	.85	1.50	.13	3.02	Black	P45	1 9/16	10
LCCF1/0-56CH-X	1/0 AWG	1/0 AWG	5/16	.88	.85	1.50	.13	3.15	Black	P45	1 9/16	10
LCCF1/0-38DH-X			3/8	1.00	.85	1.50	.13	3.34	Black	P45	1 9/16	10
LCCF1/0-12H-X			1/2	1.75	.85	1.50	.13	4.50	Black	P45	1 9/16	10
LCCF2/0-14AH-X	2/0 AWG	2/0 AWG	1/4	.63	.96	1.50	.13	2.92	Orange	P50	1 9/16	10
LCCF2/0-14BH-X			1/4	.75	.96	1.50	.13	3.05	Orange	P50	1 9/16	10
LCCF2/0-38DH-X			3/8	1.00	.96	1.50	.13	3.36	Orange	P50	1 9/16	10
LCCF2/0-12H-X	3/0 AWG	3/0 AWG	1/2	1.75	.96	1.50	.13	4.52	Orange	P50	1 9/16	10
LCCF3/0-14BH-X			1/4	.75	1.06	1.56	.14	3.14	Purple	P54	1 5/8	10
LCCF3/0-38DH-X			3/8	1.00	1.06	1.56	.14	3.47	Purple	P54	1 5/8	10
LCCF3/0-12H-X	3/0 AWG	3/0 AWG	1/2	1.75	1.06	1.56	.14	4.61	Purple	P54	1 5/8	10

‡See pages D3.70, D3.71 for tool and die information.

**Consult cable manufacturer for voltage stress relief instructions with applications greater than 2000 V.

◆NEMA hole sizes and spacing.

Table continues on page D2.100

A.
System
Overview

B1.
Cable Ties

B2.
Cable
Accessories

B3.
Stainless
Steel Ties

C1.
Wiring
Duct

C2.
Surface
Raceway

C3.
Abrasion
Protection

C4.
Cable
Management

D1.
Terminals

D2.
Power
Connectors

D3.
Grounding
Connectors

E1.
Labeling
Systems

E2.
Labels

E3.
Pre-Printed
& Write-On
Markers

E4.
Permanent
Identification

E5.
Lockout/
Tagout
& Safety
Solutions

F.
Index



Flex Conductor, Two-Hole, Long Barrel, Flared NEBS Lug, 45° Angle (continued)

Part Number	Flex Conductor Size		Stud Hole Size (In.)	Stud Hole Spacing (In.)	Figure Dimensions (In.)				PANDUIT Color Code	PANDUIT Die Index No.‡	Wire Strip Length (In.)	Std. Pkg. Qty.
	Class K and M	Diesel Locomotive			W	B	T	L				
LCCF4/0-14BH-X	4/0 AWG	4/0 AWG	1/4	.75	1.17	1.61	.14	3.06	Yellow	P62	1 11/16	10
LCCF4/0-38DH-X			3/8	1.00	1.17	1.61	.14	3.55	Yellow	P62	1 11/16	10
LCCF4/0-38H-X			3/8	1.75	1.17	1.61	.14	4.30	Yellow	P62	1 11/16	10
◆ LCCF4/0-12H-X	250 kcmil	262.6 kcmil	1/2	1.75	1.17	1.61	.14	4.69	Yellow	P62	1 11/16	10
LCCF250-14BH-X			1/4	.75	1.28	2.24	.17	3.66	White	P66	2 5/16	10
LCCF250-38DH-X			3/8	1.00	1.28	2.24	.17	4.14	White	P66	2 5/16	10
LCCF250-12EH-X	300 kcmil	313.1 kcmil	1/2	1.25	1.28	2.24	.17	4.82	White	P66	2 5/16	10
◆ LCCF250-12H-X			1/2	1.75	1.28	2.24	.17	5.32	White	P66	2 5/16	10
LCCF300-14BH-6			1/4	.75	1.38	2.30	.18	3.77	Red	P71	2 3/8	6
LCCF300-38DH-6	350 kcmil	373.7 kcmil	3/8	1.00	1.38	2.30	.18	4.25	Red	P71	2 3/8	6
◆ LCCF300-12H-6			1/2	1.75	1.38	2.30	.18	5.43	Red	P71	2 3/8	6
LCCF350-14BH-6			1/4	.75	1.53	2.50	.22	3.98	Blue	P76	2 9/16	6
LCCF350-38DH-6	400 kcmil	444.4 kcmil	3/8	1.00	1.53	2.50	.22	4.46	Blue	P76	2 9/16	6
LCCF350-12EH-6			1/2	1.25	1.53	2.50	.22	5.14	Blue	P76	2 9/16	6
◆ LCCF350-12H-6			1/2	1.75	1.53	2.50	.22	5.64	Blue	P76	2 9/16	6
LCCF400-38DH-6	500 kcmil	535.3 kcmil	3/8	1.00	1.70	2.69	.26	4.66	Brown	P87	2 3/4	6
◆ LCCF400-12H-6			1/2	1.75	1.70	2.69	.26	5.84	Brown	P87	2 3/4	6
◆ LCCF500-12H-6			1/2	1.75	1.89	2.88	.26	6.18	Pink	P99	2 15/16	6
◆ LCCF600-12H-6	—	646.4 kcmil	1/2	1.75	1.95	2.94	.29	6.25	Black	P106	3	6
LCCF750-38DH-3	—	777.7 kcmil	3/8	1.00	2.17	3.00	.32	5.45	Orange	P107	3 1/16	3
◆ LCCF750-12H-3			1/2	1.75	2.17	3.00	.32	6.39	Orange	P107	3 1/16	3

‡See pages D3.70, D3.71 for tool and die information.

**Consult cable manufacturer for voltage stress relief instructions with applications greater than 2000 V.

◆NEMA hole sizes and spacing.



Flex Conductor, Two-Hole, Long Barrel, Flared NEBS Lug, 90° Angle

For Use with Flexible and Extra-Flexible Copper Conductors

Type LCCF-F

- Can be used with flex conductor class: K, M, and Diesel Locomotive
- Long barrel maximizes the number of crimps and provides premium wire pull-out strength and electrical performance
- Flared entry prevents bent back strands when inserting fine strand conductor into barrel
- Color-coded barrels marked with *PANDUIT* die index numbers for proper crimp die selection
- Enclosed barrel prevents corrosive material from entering barrel when used in harsh environments
- Tin-plated to inhibit corrosion
- UL Listed and CSA Certified to 35 KV** and temperature rated to 90°C when crimped with *PANDUIT* crimping tools and dies
- **Tested by Telcordia – meets NEBS Level 3**
- Available with NEMA hole sizes and spacing

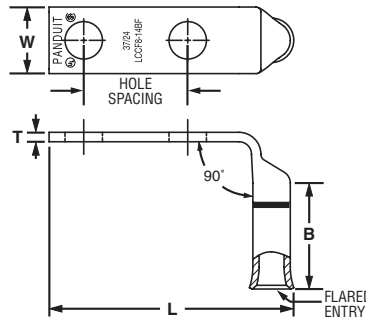

Part Number	Flex Conductor Size		Stud Hole Size (In.)	Stud Hole Spacing (In.)	Figure Dimensions (In.)				PANDUIT Color Code	PANDUIT Die Index No.‡	Wire Strip Length (In.)	Std. Pkg. Qty.
	Class K and M	Diesel Locomotive			W	B	T	L				
LCCF8-14AF-L	—	#8 AWG	1/4	.63	.48	.76	.07	1.64	Red	P21	13/16	50
LCCF8-14BF-L			1/4	.75	.48	.76	.07	1.77	Red	P21	13/16	50
LCCF8-38DF-L			3/8	1.00	.60	.76	.05	2.24	Red	P21	13/16	50
LCCF6-14AF-L	#6 AWG	#6 AWG	1/4	.63	.48	1.22	.08	1.69	Blue	P24	1 5/16	50
LCCF6-14BF-L			1/4	.75	.48	1.22	.08	1.81	Blue	P24	1 5/16	50
LCCF6-38DF-L			3/8	1.00	.62	1.22	.06	2.28	Blue	P24	1 5/16	50
LCCF4-14AF-L	#4 AWG	#4 AWG	1/4	.63	.55	1.23	.09	1.78	Gray	P29	1 5/16	50
LCCF4-14BF-L			1/4	.75	.55	1.23	.09	1.91	Gray	P29	1 5/16	50
LCCF2-14BF-E			1/4	.75	.70	1.36	.11	2.10	Brown	P33	1 7/16	20
LCCF2-56BF-E	#2 AWG	#2 AWG	5/16	.75	.70	1.36	.11	2.23	Brown	P33	1 7/16	20
LCCF2-38DF-E			3/8	1.00	.70	1.36	.11	2.55	Brown	P33	1 7/16	20
LCCF2-12F-E			1/2	1.75	.79	1.36	.09	3.72	Brown	P33	1 7/16	20
LCCF1-14AF-X	#1 AWG	#1 AWG	1/4	.63	.76	1.44	.12	2.11	Pink	P42	1 1/2	10
LCCF1-14BF-X			1/4	.75	.76	1.44	.12	2.24	Pink	P42	1 1/2	10
LCCF1-56CF-X			5/16	.88	.76	1.44	.12	2.42	Pink	P42	1 1/2	10
LCCF1-38DF-X			3/8	1.00	.76	1.44	.12	2.62	Pink	P42	1 1/2	10
LCCF1-12F-X			1/2	1.75	.80	1.44	.11	3.79	Pink	P42	1 1/2	10
LCCF1/0-14AF-X	1/0 AWG	1/0 AWG	1/4	.63	.85	1.50	.13	2.27	Black	P45	1 9/16	10
LCCF1/0-14BF-X			1/4	.75	.85	1.50	.13	2.39	Black	P45	1 9/16	10
LCCF1/0-56CF-X			5/16	.88	.85	1.50	.13	2.52	Black	P45	1 9/16	10
LCCF1/0-38DF-X			3/8	1.00	.85	1.50	.13	2.70	Black	P45	1 9/16	10
LCCF1/0-12F-X			1/2	1.75	.85	1.50	.13	3.87	Black	P45	1 9/16	10
LCCF2/0-14AF-X	2/0 AWG	2/0 AWG	1/4	.63	.96	1.50	.13	2.33	Orange	P50	1 9/16	10
LCCF2/0-14BF-X			1/4	.75	.96	1.50	.13	2.46	Orange	P50	1 9/16	10
LCCF2/0-38DF-X			3/8	1.00	.96	1.50	.13	2.77	Orange	P50	1 9/16	10
LCCF2/0-12F-X			1/2	1.75	.96	1.50	.13	3.93	Orange	P50	1 9/16	10
LCCF3/0-14BF-X	3/0 AWG	3/0 AWG	1/4	.75	1.06	1.56	.14	2.56	Purple	P54	1 5/8	10
LCCF3/0-38DF-X			3/8	1.00	1.06	1.56	.14	2.89	Purple	P54	1 5/8	10
LCCF3/0-12F-X			1/2	1.75	1.06	1.56	.14	4.03	Purple	P54	1 5/8	10

‡See pages D3.70, D3.71 for tool and die information.

**Consult cable manufacturer for voltage stress relief instructions with applications greater than 2000 V.

Table continues on page D2.102

A. System Overview

B1. Cable Ties

B2. Cable Accessories

B3. Stainless Steel Ties

C1. Wiring Duct

C2. Surface Raceway

C3. Abrasion Protection

C4. Cable Management

D1. Terminals

D2. Power Connectors

D3. Grounding Connectors

E1. Labeling Systems

E2. Labels

E3. Pre-Printed & Write-On Markers

E4. Permanent Identification

E5. Lockout/Tagout & Safety Solutions

F. Index

A.
System
Overview

B1.
Cable Ties

B2.
Cable
Accessories

B3.
Stainless
Steel Ties

C1.
Wiring
Duct

C2.
Surface
Raceway

C3.
Abrasion
Protection

C4.
Cable
Management

D1.
Terminals

D2.
Power
Connectors

D3.
Grounding
Connectors

E1.
Labeling
Systems

E2.
Labels

E3.
Pre-Printed
& Write-On
Markers

E4.
Permanent
Identification

E5.
Lockout/
Tagout
& Safety
Solutions

F.
Index



Flex Conductor, Two-Hole, Long Barrel, Flared NEBS Lug, 90° Angle (continued)

Part Number	Flex Conductor Size		Stud Hole Size (In.)	Stud Hole Spacing (In.)	Figure Dimensions (In.)				PANDUIT Color Code	PANDUIT Die Index No.‡	Wire Strip Length (In.)	Std. Pkg. Qty.
	Class K and M	Diesel Locomotive			W	B	T	L				
LCCF4/0-14BF-X	4/0 AWG	4/0 AWG	1/4	.75	1.17	1.61	.14	2.48	Yellow	P62	1 11/16	10
LCCF4/0-38DF-X			3/8	1.00	1.17	1.61	.14	2.97	Yellow	P62	1 11/16	10
LCCF4/0-38F-X			3/8	1.75	1.17	1.61	.14	3.72	Yellow	P62	1 11/16	10
LCCF4/0-12F-X	250 kcmil	262.6 kcmil	1/2	1.75	1.17	1.61	.14	4.11	Yellow	P62	1 11/16	10
LCCF250-14BF-X			1/4	.75	1.28	2.24	.17	2.54	White	P66	2 5/16	10
LCCF250-38DF-X			3/8	1.00	1.28	2.24	.17	3.02	White	P66	2 5/16	10
LCCF250-12EF-X	300 kcmil	313.1 kcmil	1/2	1.25	1.28	2.24	.17	3.70	White	P66	2 5/16	10
LCCF250-12F-X			1/2	1.75	1.28	2.24	.17	4.20	White	P66	2 5/16	10
LCCF300-14BF-6			1/4	.75	1.38	2.30	.18	2.61	Red	P71	2 3/8	6
LCCF300-38DF-6	350 kcmil	373.7 kcmil	3/8	1.00	1.38	2.30	.18	3.09	Red	P71	2 3/8	6
LCCF300-12F-6			1/2	1.75	1.38	2.30	.18	4.27	Red	P71	2 3/8	6
LCCF350-14BF-6			1/4	.75	1.53	2.50	.22	2.73	Blue	P76	2 9/16	6
LCCF350-38DF-6	400 kcmil	444.4 kcmil	3/8	1.00	1.53	2.50	.22	3.21	Blue	P76	2 9/16	6
LCCF350-12EF-6			1/2	1.25	1.53	2.50	.22	3.89	Blue	P76	2 9/16	6
LCCF350-12F-6			1/2	1.75	1.53	2.50	.22	4.39	Blue	P76	2 9/16	6
LCCF400-38DF-6	500 kcmil	535.3 kcmil	3/8	1.00	1.70	2.69	.26	3.33	Brown	P87	2 3/4	6
LCCF400-12F-6			1/2	1.75	1.70	2.69	.26	4.51	Brown	P87	2 3/4	6
LCCF500-12F-6			1/2	1.75	1.89	2.88	.26	4.67	Pink	P99	2 15/16	6
LCCF600-12F-6	—	646.4 kcmil	1/2	1.75	1.95	2.88	.29	4.73	Black	P106	3	6
LCCF750-38DF-3	—	777.7 kcmil	3/8	1.00	2.17	3.00	.32	3.96	Orange	P107	3 1/16	3
LCCF750-12F-3			1/2	1.75	2.17	3.00	.32	4.90	Orange	P107	3 1/16	3

‡See pages D3.70, D3.71 for tool and die information.

**Consult cable manufacturer for voltage stress relief instructions with applications greater than 2000 V.

◆NEMA hole sizes and spacing.



Flex Conductor, Standard Barrel, Flared, NEBS Butt Splice

For Use with Flexible and Extra-Flexible Copper Conductors

Type SCSF

- Can be used with flex conductor class: K, M, and Diesel Locomotive
- Flared entry prevents bent back strands when inserting fine strand conductor into barrel
- Color-coded barrels marked with *PANDUIT* die index numbers for proper crimp die selection
- Internal wire stops to prevent over-insertion of conductor
- Tin-plated to inhibit corrosion
- UL Listed and CSA Certified to 35 KV** and temperature rated to 90°C when crimped with *PANDUIT* crimping tools and dies
- **Tested by Telcordia – meets NEBS Level 3**
- American Bureau of Shipping approved

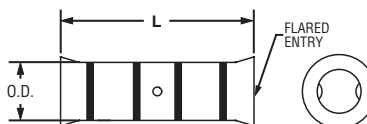

Part Number	Flex Conductor Size		Figure Dimensions (In.)		PANDUIT Color Code	PANDUIT Die Index No.‡	Wire Strip Length (In.)	Std. Pkg. Qty.
	Class K and M	Diesel Locomotive	Barrel O.D.	L				
SCSF8-L	—	#8 AWG	.27	1.50	Red	P21	11/16	50
SCSF6-L	#6 AWG	#6 AWG	.31	1.75	Blue	P24	13/16	50
SCSF4-L	#4 AWG	#4 AWG	.38	1.75	Gray	P29	13/16	50
SCSF2-E	#2 AWG	#2 AWG	.47	1.87	Brown	P33	7/8	20
SCSF1-X	#1 AWG	#1 AWG	.52	1.87	Pink	P42	7/8	10
SCSF1/0-X	1/0 AWG	1/0 AWG	.58	2.50	Black	P45	1 3/16	10
SCSF2/0-X	2/0 AWG	2/0 AWG	.64	2.50	Orange	P50	1 3/16	10
SCSF3/0-X	3/0 AWG	3/0 AWG	.71	2.50	Purple	P54	1 3/16	10
SCSF4/0-X	4/0 AWG	4/0 AWG	.77	2.50	Yellow	P62	1 3/16	10
SCSF250-X	250 kcmil	262.6 kcmil	.88	2.50	White	P66	1 3/16	10
SCSF300-6	300 kcmil	313.1 kcmil	.95	2.56	Red	P71	1 1/4	6
SCSF350-6	350 kcmil	373.7 kcmil	1.06	2.94	Blue	P76	1 1/2	6

‡See pages D3.70, D3.71 for tool and die information.

**Consult cable manufacturer for voltage stress relief instructions with applications greater than 2000 V.

A. System Overview

B1. Cable Ties

B2. Cable Accessories

B3. Stainless Steel Ties

C1. Wiring Duct

C2. Surface Raceway

C3. Abrasion Protection

C4. Cable Management

D1. Terminals

D2. Power Connectors

D3. Grounding Connectors

E1. Labeling Systems

E2. Labels

E3. Pre-Printed & Write-On Markers

E4. Permanent Identification

E5. Lockout/Tagout & Safety Solutions

F. Index

A.
System
Overview

Code/Flex Conductor, with Window, In-Line Reducing Splice Kit

B1.
Cable Ties

Type RSCK

- Includes all components in one package for making a complete electrical connection: *PANDUIT* copper compression RSC in-line reducing splice (see pages D2.106 – D2.107) and crystal clear PVC heat shrink sleeves pre-cut to length to insulate reducing splice
- PANDUIT* RSC in-line reducing splice is UL Listed and temperature rated to 90°C when crimped with *PANDUIT* crimping tools and dies
- PANDUIT* crystal clear PVC heat shrink has a UL 224 VW-1 flammability rating and passes Telcordia GR-347-CORE Compression and Cut-Through Penetration Test and Abrasion Resistance Test
- PANDUIT* crystal clear PVC heat shrink is UL Recognized with a temperature rating of 150°C, high temperature insulating property
- Rated for 600 V applications when *PANDUIT* crystal clear PVC heat shrink is applied

B2.
Cable
Accessories

B3.
Stainless
Steel Ties



C1.
Wiring
Duct

C2.
Surface
Raceway

C3.
Abrasion
Protection

C4.
Cable
Management

D1.
Terminals

D2.
Power
Connectors

D3.
Grounding
Connectors

E1.
Labeling
Systems

E2.
Labels

E3.
Pre-Printed
& Write-On
Markers

E4.
Permanent
Identification

E5.
Lockout/
Tagout
& Safety
Solutions

F.
Index

Part Number	Part Description	Std. Pkg. Qty.
RSCK4-6-1	Kit contains: 1 pc. RSC4-6-L copper compression in-line reducing splice. 1 pc. HSTTPN50-713-Q crystal clear PVC heat shrink 1/2" dia. x 7.125" long.	1
RSCK2-6-1	Kit contains: 1 pc. RSC2-6-Q copper compression in-line reducing splice. 1 pc. HSTTPN62-750-Q crystal clear PVC heat shrink 5/8" dia. x 7.500" long.	1
RSCK2-4-1	Kit contains: 1 pc. RSC2-4-Q copper compression in-line reducing splice. 1 pc. HSTTPN62-750-Q crystal clear PVC heat shrink 5/8" dia. x 7.500" long.	1
RSCK1/0-6-1	Kit contains: 1 pc. RSC1/0-6-X copper compression in-line reducing splice. 1 pc. HSTTPN75-775-Q crystal clear PVC heat shrink 3/4" dia. x 7.750" long. 1 pc. HSTTPN50-438-L crystal clear PVC heat shrink 1/2" dia. x 4.375" long.	1
RSCK1/0-4-1	Kit contains: 1 pc. RSC1/0-4-X copper compression in-line reducing splice. 1 pc. HSTTPN75-775-Q crystal clear PVC heat shrink 3/4" dia. x 7.750" long. 1 pc. HSTTPN50-438-L crystal clear PVC heat shrink 1/2" dia. x 4.375" long.	1
RSCK2/0-6-1	Kit contains: 1 pc. RSC2/0-6-X copper compression in-line reducing splice. 1 pc. HSTTPN75-775-Q crystal clear PVC heat shrink 3/4" dia. x 7.750" long. 1 pc. HSTTPN50-438-L crystal clear PVC heat shrink 1/2" dia. x 4.375" long.	1
RSCK2/0-4-1	Kit contains: 1 pc. RSC2/0-4-X copper compression in-line reducing splice. 1 pc. HSTTPN75-775-Q crystal clear PVC heat shrink 3/4" dia. x 7.750" long. 1 pc. HSTTPN50-438-L crystal clear PVC heat shrink 1/2" dia. x 4.375" long.	1
RSCK4/0-6-1	Kit contains: 1 pc. RSC4/0-6-X copper compression in-line reducing splice. 1 pc. HSTTPN100-775-Q crystal clear PVC heat shrink 1" dia. x 7.750" long. 1 pc. HSTTPN50-438-L crystal clear PVC heat shrink 1/2" dia. x 4.375" long.	1
RSCK4/0-4-1	Kit contains: 1 pc. RSC4/0-4-X copper compression in-line reducing splice. 1 pc. HSTTPN100-775-Q crystal clear PVC heat shrink 1" dia. x 7.750" long. 1 pc. HSTTPN50-438-L crystal clear PVC heat shrink 1/2" dia. x 4.375" long.	1

Code/Flex Conductor, with Window, In-Line Reducing Splice Kit (continued)



Part Number	Part Description	Std. Pkg. Qty.
RSCK4/0-1/0-1	Kit contains: 1 pc. RSC4/0-1/0-X copper compression in-line reducing splice. 1 pc. HSTTPN100-775-Q crystal clear PVC heat shrink 1" dia. x 7.750" long. 1 pc. HSTTPN75-775-Q crystal clear PVC heat shrink 3/4" dia. x 7.750" long.	1
RSCK4/0-2/0-1	Kit contains: 1 pc. RSC4/0-2/0-X copper compression in-line reducing splice. 1 pc. HSTTPN100-775-Q crystal clear PVC heat shrink 1" dia. x 7.750" long. 1 pc. HSTTPN75-775-Q crystal clear PVC heat shrink 3/4" dia. x 7.750" long.	1
RSCK500-X4/0-1	Kit contains: 1 pc. RSC500-X4/0-6 copper compression in-line reducing splice. 1 pc. HSTTPN150-925-X crystal clear PVC heat shrink 1 1/2" dia. x 9.250" long.	1
RSCK500-X350-1	Kit contains: 1 pc. RSC500-X350-6 copper compression in-line reducing splice. 1 pc. HSTTPN150-925-X crystal clear PVC heat shrink 1 1/2" dia. x 9.250" long.	1
RSCK750-4/0-1	Kit contains: 1 pc. RSC750-4/0-6 copper compression in-line reducing splice. 1 pc. HSTTPN150-925-X crystal clear PVC heat shrink 1 1/2" dia. x 9.250" long. 1 pc. HSTTPN100-775-Q crystal clear PVC heat shrink 1" dia. x 7.750" long.	1
RSCK750-X4/0-1	Kit contains: 1 pc. RSC750-X4/0-6 copper compression in-line reducing splice. 1 pc. HSTTPN150-925-X crystal clear PVC heat shrink 1 1/2" dia. x 9.250" long.	1
RSCK750-X350-1	Kit contains: 1 pc. RSC750-X350-6 copper compression in-line reducing splice. 1 pc. HSTTPN150-925-X crystal clear PVC heat shrink 1 1/2" dia. x 9.250" long.	1
RSCK750-500-1	Kit contains: 1 pc. RSC750-500-6 copper compression in-line reducing splice. 1 pc. HSTTPN150-925-X crystal clear PVC heat shrink 1 1/2" dia. x 9.250" long.	1
RSCK750-X500-1	Kit contains: 1 pc. RSC750-X500-6 copper compression in-line reducing splice. 1 pc. HSTTPN150-925-X crystal clear PVC heat shrink 1 1/2" dia. x 9.250" long.	1
RSCK750-750-1	Kit contains: 1 pc. RSC750-750-6 copper compression in-line reducing splice. 1 pc. HSTTPN150-925-X crystal clear PVC heat shrink 1 1/2" dia. x 9.250" long.	1
RSCKX750-4/0-1	Kit contains: 1 pc. RSCX750-4/0-3 copper compression in-line reducing splice. 1 pc. HSTTPN200-950-X crystal clear PVC heat shrink 2" dia. x 9.500" long. 1 pc. HSTTPN100-775-Q crystal clear PVC heat shrink 1" dia. x 7.750" long.	1
RSCKX750-750-1	Kit contains: 1 pc. RSCX750-750-3 copper compression in-line reducing splice. 1 pc. HSTTPN200-950-X crystal clear PVC heat shrink 2" dia. x 9.500" long.	1

A.
System
Overview

B1.
Cable Ties

B2.
Cable
Accessories

B3.
Stainless
Steel Ties

C1.
Wiring
Duct

C2.
Surface
Raceway

C3.
Abrasion
Protection

C4.
Cable
Management

D1.
Terminals

D2.
Power
Connectors

D3.
Grounding
Connectors

E1.
Labeling
Systems

E2.
Labels

E3.
Pre-Printed
& Write-On
Markers

E4.
Permanent
Identification

E5.
Lockout/
Tagout
& Safety
Solutions

F.
Index

A. System Overview

B1. Cable Ties



Code/Flex Conductor, with Window, In-Line Reducing Splice

For Use with Stranded Copper Code and Class I Flex Conductors

Type RSC

- Low profile design provides minimum space requirements
- Manufactured from seamless, high conductivity copper tubing
- Color-coded barrels marked with *PANDUIT* and specified competitor die index numbers for proper crimp die selection
- Inspection windows in each barrel to visually assure full conductor insertion
- Generous internally beveled wire entry for easy conductor insertion
- Tin-plated to inhibit corrosion
- UL Listed and CSA Certified to 35 KV** and temperature rated to 90°C when crimped with *PANDUIT* and specified competitor crimping tools and dies
- Also sold as a kit with crystal clear PVC heat shrink (see pages D2.104, D2.105)

B2. Cable Accessories

B3. Stainless Steel Ties

C1. Wiring Duct

C2. Surface Raceway

C3. Abrasion Protection

C4. Cable Management

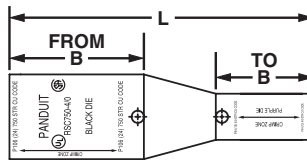

D1. Terminals

D2. Power Connectors

D3. Grounding Connectors

E1. Labeling Systems

E2. Labels

E3. Pre-Printed & Write-On Markers

E4. Permanent Identification

E5. Lockout/Tagout & Safety Solutions

F. Index

Part Number	Copper Conductor Size	Figure Dimensions (In.)		PANDUIT Color Code	PANDUIT Die Index No.‡	Burndy Die Index No.‡	T&B Die Index No.‡	Wire Strip Length (In.)	Std. Pkg. Qty.	
		B	L							
RSC4-6-L	Reduces From	#4 – 3 AWG STR,#2 AWG SOL	1.05	2.54	Gray	P29	8	29	1	1
	Reduces To	#6 AWG	1.38		Blue	P24	7	24	1 5/16	
RSC2-6-Q	Reduces From	#2 AWG	1.05	2.62	Brown	P33	10	33	1	1
	Reduces To	#6 AWG	1.38		Blue	P24	7	34	1 5/16	
RSC2-4-Q	Reduces From	#2 AWG	1.05	2.50	Brown	P33	10	33	1	1
	Reduces To	#4 – 3 AWG STR,#2 AWG SOL	1.38		Gray	P29	8	29	1 5/16	
RSC1/0-6-X	Reduces From	1/0 AWG	1.05	2.81	Pink	P42	12	42	1	1
	Reduces To	#6 AWG	1.38		Blue	P24	7	24	1 5/16	
RSC1/0-4-X	Reduces From	1/0 AWG	1.05	2.70	Pink	P42	12	42	1	1
	Reduces To	#4 – 3 AWG STR,#2 AWG SOL	1.38		Gray	P29	8	29	1 5/16	
RSC2/0-6-X	Reduces From	2/0 AWG	1.13	2.99	Black	P45	13	45	1 1/16	1
	Reduces To	#6 AWG	1.38		Blue	P24	7	24	1 5/16	
RSC2/0-4-X	Reduces From	2/0 AWG	1.13	2.88	Black	P45	13	45	1 1/16	1
	Reduces To	#4 – 3 AWG STR,#2 AWG SOL	1.38		Gray	P29	8	29	1 5/16	
RSC4/0-6-X	Reduces From	4/0 AWG	1.13	3.24	Purple	P54	15	54	1 1/16	1
	Reduces To	#6 AWG	1.38		Blue	P24	7	24	1 5/16	
RSC4/0-4-X	Reduces From	4/0 AWG	1.13	3.12	Purple	P54	15	54	1 1/16	1
	Reduces To	#4 – 3 AWG STR,#2 AWG SOL	1.38		Gray	P29	8	29	1 5/16	
RSC4/0-1/0-X	Reduces From	4/0 AWG	1.16	3.13	Purple	P54	15	54	1 1/16	1
	Reduces To	1/0 AWG	1.63		Pink	P42	12	42	1 9/16	
RSC4/0-2/0-X	Reduces From	4/0 AWG	1.16	2.90	Purple	P54	15	54	1 1/16	1
	Reduces To	2/0 AWG	1.50		Black	P45	13	45	1 7/16	
RSC500-X4/0-6	Reduces From	500 kcmil	1.94	3.97	Brown	P87	20	87	1 7/8	1
	Reduces To	4/0 Flex	1.50		Yellow	P62	16	62	1 7/16	
RSC500-X350-6	Reduces From	500 kcmil	1.94	4.38	Brown	P87	20	87	1 7/8	1
	Reduces To	350 Flex	1.94		Blue	P76	19	76	1 7/8	

‡See pages D3.72 – D3.77 for tool and die information.

**Consult cable manufacturer for voltage stress relief instructions with applications greater than 2000 V.



Code/Flex Conductor, with Window, In-Line Reducing Splice (continued)

Part Number		Copper Conductor Size	Figure Dimensions (In.)		PANDUIT Color Code	PANDUIT Die Index No.‡	Burndy Die Index No.‡	T&B Die Index No.‡	Wire Strip Length (In.)	Std. Pkg. Qty.
			B	L						
RSC750-4/0-6	Reduces From	750 kcmil	2.06	4.66	Black	P106	24	106	2	1
	Reduces To	4/0 AWG	1.50		Purple	P54	15	54	1 5/8	
RSC750-X4/0-6	Reduces From	750 kcmil	2.06	4.54	Black	P106	24	106	2	1
	Reduces To	4/0 Flex	1.50		Yellow	P62	16	62	1 7/16	
RSC750-X350-6	Reduces From	750 kcmil	2.06	4.45	Black	P106	24	106	2	1
	Reduces To	350 Flex	1.94		Blue	P76	19	76	1 7/8	
RSC750-500-6	Reduces From	750 kcmil	2.06	4.45	Black	P106	24	106	2	1
	Reduces To	500 kcmil	1.94		Brown	P87	20	87	1 7/8	
RSC750-X500-6	Reduces From	750 kcmil	2.06	4.63	Black	P106	24	106	2	1
	Reduces To	500 Flex	2.06		Pink	P99	400	99	2	
RSC750-750-6	Reduces From	750 kcmil	2.06	4.63	Black	P106	24	106	2	1
	Reduces To	750 kcmil	2.06		Black	P106	24	106	2	
RSCX750-4/0-3	Reduces From	750 Flex	2.06	5.04	Yellow	P115	115	115	2	1
	Reduces To	4/0 AWG	1.50		Purple	P54	15	54	1 5/8	
RSCX750-750-3	Reduces From	750 Flex	2.06	4.50	Yellow	P115	115	115	2	1
	Reduces To	750 kcmil	2.06		Black	P106	24	106	2	

‡See pages D3.72 – D3.77 for tool and die information.

**Consult cable manufacturer for voltage stress relief instructions with applications greater than 2000 V.

A.
System
Overview

B1.
Cable
Ties

B2.
Cable
Accessories

B3.
Stainless
Steel Ties

C1.
Wiring
Duct

C2.
Surface
Raceway

C3.
Abrasion
Protection

C4.
Cable
Management

D1.
Terminals

D2.
Power
Connectors

D3.
Grounding
Connectors

E1.
Labeling
Systems

E2.
Labels

E3.
Pre-Printed
& Write-On
Markers

E4.
Permanent
Identification

E5.
Lockout/
Tagout
& Safety
Solutions

F.
Index

A. System Overview

Part Number System for Metric Lugs

B1. Cable Ties

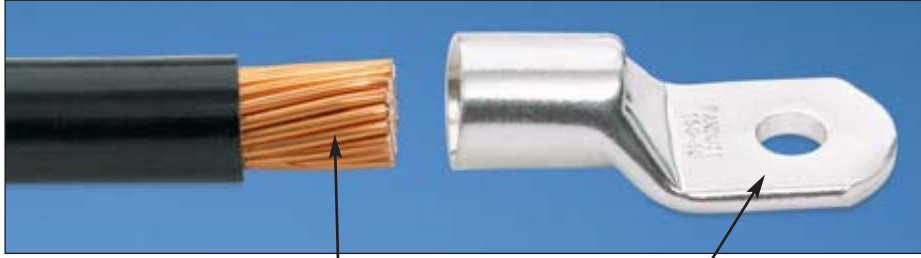

LCMA **150** — **10** —

150 = 150mm² 10 = 10mm

X

1 = 1 X = 10 C = 100
5 = 5 L = 50

B2. Cable Accessories

B3. Stainless Steel Ties

C1. Wiring Duct

Part Number System for *PAN-LUG*™ Compression Metric Lugs

C2. Surface Raceway

LCMA **150** — **10** — **X**

Type Conductor Size Stud Hole Size Standard Package Size

C3. Abrasion Protection

C4. Cable Management

5 = #5
6 = 6mm
8 = 8mm
10 = 10mm
12 = 12mm
14 = 14mm
16 = 16mm
20 = 20mm
00 = Blank Tongue*

1 = 1
5 = 5
6 = 6
X = 10
Q = 25
L = 50
C = 100

D1. Terminals

D2. Power Connectors

NEW! **Metric Conductor, One-Hole, Standard Barrel with Window Lug**

D3. Grounding Connectors

For Use with Class 2 Stranded Copper Conductors

Type LCMA

- Inspection window to visually assure full conductor insertion
- Tin-plated to inhibit corrosion
- UL Listed, UL Recognized, and CSA Certified to 35 KV** and temperature rated to 90°C when crimped with *PANDUIT* tools and dies
- Product information marked on connector for selection and installation
- Rounded tongue convenient for use in tight spaces
- Internally beveled wire entry for fast and easy installation

E1. Labeling Systems

E2. Labels



E3. Pre-Printed & Write-On Markers

E4. Permanent Identification

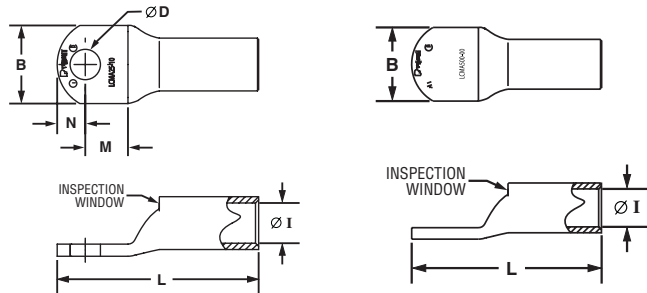

E5. Lockout/Tagout & Safety Solutions

Part Number	Copper Conductor Size Class 2 (mm ²)	Current Rating (Amps)	Stud Hole Size (mm)	Figure Dimensions (mm)						PANDUIT Die Index No.‡	Std. Pkg. Qty.
				ØI	B	M	N	I	ØD		
LCMA6-5-C*	4 – 6	30	M5	3.8	10.0	7.8	6.2	27.5	5.5	P10	100
LCMA6-6-C*	4 – 6	30	M6	3.8	10.8	7.8	6.2	27.5	6.6	P10	100
LCMA6-8-C*	4 – 6	30	M8	3.8	13.0	8.0	8.0	30.5	9.0	P10	100

F. Index

‡See page D3.79 for tool and die information.
*UL Recognized only.
**Consult cable manufacturer for voltage stress relief instructions with applications greater than 2000 V.



Metric Conductor, One-Hole, Standard Barrel with Window Lug (continued)



Part Number	Copper Conductor Size Class 2 (mm ²)	Current Rating (Amps)	Stud Hole Size (mm)	Figure Dimensions (mm)						PANDUIT Die Index No.‡	Std. Pkg. Qty.
				ØI	B	M	N	I	ØD		
LCMA10-5-C	10	—	M5	4.5	11.0	9.8	6.0	30.8	5.5	P21	100
LCMA10-6-C	10	—	M6	4.5	11.0	9.8	6.0	30.8	6.6	P21	100
LCMA10-8-C	10	—	M8	4.5	13.0	8.5	8.0	30.8	9.0	P21	100
LCMA10-10-C	10	—	M10	4.4	14.5	8.5	8.0	30.8	11.0	P21	100
LCMA16-5-C*	16	65	M5	5.5	13.0	10.3	6.5	34.5	5.5	P24	100
LCMA16-6-C*	16	65	M6	5.5	13.0	10.3	6.5	34.5	6.6	P24	100
LCMA16-8-C*	16	65	M8	5.5	13.0	10.3	6.5	34.5	9.0	P24	100
LCMA16-10-C*	16	65	M10	5.5	15.0	10.2	8.0	36.7	11.0	P24	100
LCMA25-6-C	25	—	M6	6.9	14.0	10.0	8.0	37.0	6.6	P29	100
LCMA25-8-C	25	—	M8	6.9	15.5	10.0	8.0	37.0	9.0	P29	100
LCMA25-10-C	25	—	M10	6.9	15.5	10.0	8.0	37.0	11.0	P29	100
LCMA35-6-C	35	—	M6	8.2	15.5	12.3	8.5	42.0	6.6	P33	100
LCMA35-8-C	35	—	M8	8.2	15.5	12.3	8.5	42.0	9.0	P33	100
LCMA35-10-C	35	—	M10	8.2	15.5	12.3	8.5	42.0	11.0	P33	100
LCMA35-12-C	35	—	M12	8.2	21.5	14.5	11.5	48.0	14.0	P33	100
LCMA50-6-L	50	—	M6	9.8	18.0	11.5	10.0	46.5	6.6	P42	50
LCMA50-8-L	50	—	M8	9.8	18.0	11.5	10.0	46.5	9.0	P42	50
LCMA50-10-L	50	—	M10	9.8	18.0	11.5	10.0	46.5	11.0	P42	50
LCMA50-12-L	50	—	M12	9.8	23.0	14.0	11.0	50.0	14.0	P42	50
LCMA70-6-L	70	—	M6	11.5	20.8	14.5	11.5	53.5	6.6	P45	50
LCMA70-8-L	70	—	M8	11.5	20.8	14.5	11.5	53.5	9.0	P45	50
LCMA70-10-L	70	—	M10	11.5	20.8	14.5	11.5	53.5	11.0	P45	50
LCMA70-12-L	70	—	M12	11.5	20.8	14.5	11.5	53.5	14.0	P45	50
LCMA95-8-L	95	—	M8	13.5	24.5	15.0	13.5	60.5	9.0	P54	50
LCMA95-10-L	95	—	M10	13.5	24.5	15.0	13.5	60.5	11.0	P54	50
LCMA95-12-L	95	—	M12	13.5	24.5	15.0	13.5	60.5	14.0	P54	50
LCMA95-16-L	95	—	M16	13.5	24.5	15.0	13.5	60.5	18.0	P54	50
LCMA120-8-L	120	—	M8	15.2	27.5	15.5	14.5	65.0	9.0	P62	50
LCMA120-10-L	120	—	M10	15.2	27.5	15.5	14.5	65.0	11.0	P62	50
LCMA120-12-L	120	—	M12	15.2	27.5	15.5	14.5	65.0	14.0	P62	50
LCMA120-16-L	120	—	M16	15.2	27.5	15.5	14.5	65.0	18.0	P62	50
LCMA150-8-X	150	—	M8	16.5	30.5	18.0	16.5	70.5	9.0	P66	10
LCMA150-10-X	150	—	M10	16.5	30.5	18.0	16.5	70.5	11.0	P66	10
LCMA150-12-X	150	—	M12	16.5	30.5	18.0	16.5	70.5	14.0	P66	10
LCMA150-16-X	150	—	M16	16.5	30.5	18.0	16.5	70.5	18.0	P66	10
LCMA150-20-X	150	—	M20	16.5	30.5	22.0	16.5	74.0	22.0	P66	10
LCMA185-10-X	185	—	M10	18.6	33.5	16.5	17.5	72.5	11.0	P76	10
LCMA185-12-X	185	—	M12	18.6	33.5	16.5	17.5	72.5	14.0	P76	10
LCMA185-16-X	185	—	M16	18.6	33.5	16.5	17.5	72.5	18.0	P76	10
LCMA185-20-X	185	—	M20	18.6	33.5	21.0	17.5	77.0	22.0	P76	10
LCMA240-10-X	240	—	M10	20.8	37.5	21.0	19.5	86.5	11.0	P87	10
LCMA240-12-X	240	—	M12	20.8	37.5	21.0	19.5	86.5	14.0	P87	10
LCMA240-16-X	240	—	M16	20.8	37.5	21.0	19.5	86.5	18.0	P87	10
LCMA240-20-X	240	—	M20	20.8	37.5	21.0	19.5	86.5	22.0	P87	10
LCMA300-10-5	300	—	M10	23.5	42.5	22.0	20.0	94.5	11.0	P94	5
LCMA300-12-5	300	—	M12	23.5	42.5	22.0	20.0	94.5	14.0	P94	5
LCMA300-16-5	300	—	M16	23.5	42.5	22.0	20.0	94.5	18.0	P94	5
LCMA300-20-5	300	—	M20	23.5	42.5	22.0	20.0	94.5	22.0	P94	5
LCMA400-12-5	400	—	M12	27.0	49.5	26.5	23.5	107.0	14.0	P106	5
LCMA400-16-5	400	—	M16	27.0	49.5	26.5	23.5	107.0	18.0	P106	5
LCMA400-20-5	400	—	M20	27.0	49.5	26.5	23.5	107.0	22.0	P106	5
LCMA500-12-1	500	—	M12	31.0	57.5	28.5	25.5	120.0	14.0	P125	1
LCMA500-16-1	500	—	M16	31.0	57.5	28.5	25.5	120.0	18.0	P125	1
LCMA500-20-1	500	—	M20	31.0	57.5	28.5	25.5	120.0	22.0	P125	1
LCMA500-00-1*	500	—	Blank	31.0	57.5	—	—	120.0	—	P125	1
LCMA630-16-1	630	—	M16	34.5	63.0	28.5	27.5	131.0	18.0	P125	1
LCMA630-20-1	630	—	M20	34.5	63.0	28.5	27.5	131.0	22.0	P125	1
LCMA630-00-1*	630	—	Blank	34.5	63.0	—	—	131.0	—	P125	1

‡See page D3.79 for tool and die information.

*UL Recognized only.

**Consult cable manufacturer for voltage stress relief instructions with applications greater than 2000 V.

A. System Overview

B1. Cable Ties

B2. Cable Accessories

B3. Stainless Steel Ties

C1. Wiring Duct

C2. Surface Raceway

C3. Abrasion Protection

C4. Cable Management

D1. Terminals

D2. Power Connectors

D3. Grounding Connectors

E1. Labeling Systems

E2. Labels

E3. Pre-Printed & Write-On Markers

E4. Permanent Identification

E5. Lockout/Tagout & Safety Solutions

F. Index

A. System Overview

B1. Cable Ties

B2. Cable Accessories

B3. Stainless Steel Ties

C1. Wiring Duct

C2. Surface Raceway

C3. Abrasion Protection

C4. Cable Management

D1. Terminals

D2. Power Connectors

D3. Grounding Connectors

E1. Labeling Systems

E2. Labels

E3. Pre-Printed & Write-On Markers

E4. Permanent Identification

E5. Lockout/Tagout & Safety Solutions

F. Index



Metric Conductor, Two-Hole, Standard Barrel with Window Lug

For Use with Class 2 Stranded Copper Conductors

Type LCMD

- Inspection window to visually assure full conductor insertion
- Tin-plated to inhibit corrosion
- UL Listed, UL Recognized, and CSA Certified to 35 KV** and temperature rated to 90°C when crimped with *PANDUIT* tools and dies
- Product information marked on connector for selection and installation
- Internally beveled wire entry for fast and easy installation

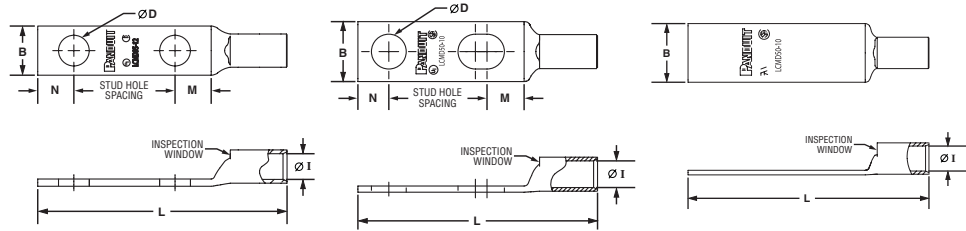

Part Number	Copper Conductor Size Class 2 (mm ²)	Current Rating (Amps)	Stud Hole Size (mm)	Stud Hole Spacing (In.)	Figure Dimensions (mm)						PANDUIT Die Index No.‡	Std. Pkg. Qty.
					ØI	B	M	N	L	ØD		
LCMD6-5CD-Q*	4 – 6	30	M5	22.0 – 25.0	3.8	10.0	7.8	6.2	52.5	5.5	P10	25
LCMD10-6CD-Q	10	—	M6	22.0 – 25.0	4.5	11.0	9.8	6.0	55.8	6.6	P21	25
LCMD10-8-Q	10	—	M8	44.5	4.5	13.0	8.5	8.0	75.3	9.0	P21	25
LCMD10-00-Q*	10	90	Blank	—	4.4	14.5	—	—	75.3	—	P21	25
LCMD16-6CD-Q*	16	65	M6	22.0 – 25.0	5.5	13.0	10.3	6.5	59.5	6.6	P24	25
LCMD16-8-Q*	16	65	M8	44.5	5.5	13.0	10.3	6.5	79.0	9.0	P24	25
LCMD16-00-Q*	16	65	Blank	—	5.5	15.0	—	—	81.2	—	P24	25
LCMD25-8CD-Q*	25	—	M8	22.0 – 25.0	6.9	15.5	10.0	8.0	62.0	9.0	P29	25
LCMD25-8-Q	25	—	M8	44.5	6.9	15.5	10.0	8.0	81.5	9.0	P29	25
LCMD25-10-Q	25	—	M10	44.5	6.9	15.5	10.0	8.0	81.5	11.0	P29	25
LCMD25-12-Q	25	—	M12	44.5	6.9	18.0	14.5	11.5	89.5	14.0	P29	25
LCMD25-00-Q*	25	—	Blank	—	7.1	20.0	—	—	89.5	—	P29	25
LCMD35-8CD-Q	35	—	M8	22.0 – 25.0	8.2	15.5	12.3	8.5	67.0	9.0	P33	25
LCMD35-10-Q	35	—	M10	44.5	8.2	15.5	12.3	8.5	86.5	11.0	P33	25
LCMD35-12-Q	35	—	M12	44.5	8.2	21.5	14.5	11.5	92.5	14.0	P33	25
LCMD35-00-Q*	35	—	Blank	—	8.2	21.5	—	—	92.5	—	P33	25
LCMD50-10CD-X	50	—	M10	22.0 – 25.0	9.8	18.0	11.5	10.0	71.5	11.0	P42	10
LCMD50-10-X	50	—	M10	44.5	9.8	18.0	11.5	10.0	91.0	11.0	P42	10
LCMD50-12-X	50	—	M12	44.5	9.8	23.0	14.0	11.0	94.5	14.0	P42	10
LCMD50-00-X*	50	—	Blank	—	9.8	23.0	—	—	94.5	—	P42	10
LCMD70-10CD-X	70	—	M10	22.0 – 25.0	11.5	20.5	14.5	11.0	78.5	11.0	P45	10
LCMD70-10-X	70	—	M10	44.5	11.5	20.8	14.5	11.5	98.0	11.0	P45	10
LCMD70-12-X	70	—	M12	44.5	11.5	20.8	14.5	11.5	98.0	14.0	P45	10
LCMD70-00-X*	70	—	Blank	—	11.5	20.8	—	—	98.0	—	P45	10
LCMD95-10CD-X	95	—	M10	22.0 – 25.0	13.5	24.5	15.0	13.0	85.5	11.0	P54	10
LCMD95-12-X	95	—	M12	44.5	13.5	24.5	15.0	13.5	105.0	14.0	P54	10
LCMD95-14-X	95	—	M14	44.5	13.5	24.5	15.0	13.5	105.0	16.0	P54	10
LCMD95-00-X*	95	—	Blank	—	13.5	24.5	—	—	105.0	—	P54	10
LCMD120-10CD-X	120	—	M10	22.0 – 25.0	15.2	27.5	15.5	14.0	90.0	11.0	P62	10
LCMD120-12-X	120	—	M12	44.5	15.2	27.5	15.5	14.5	109.5	14.0	P62	10
LCMD120-14-X	120	—	M14	44.5	15.2	27.5	15.5	14.5	109.5	16.0	P62	10
LCMD120-00-X*	120	—	Blank	—	15.2	27.5	—	—	109.5	—	P62	10
LCMD150-10CD-X	150	—	M10	22.0 – 25.0	16.5	30.5	18.0	16.0	95.5	11.0	P66	10
LCMD150-12-X	150	—	M12	44.5	16.5	30.5	18.0	16.5	115.0	14.0	P66	10
LCMD150-14-X	150	—	M14	44.5	16.5	30.5	22.0	16.5	118.5	16.0	P66	10
LCMD150-00-X*	150	—	Blank	—	16.5	30.5	—	—	118.5	—	P66	10

‡See page D3.79 for tool and die information.

*UL Recognized only.

**Consult cable manufacturer for voltage stress relief instructions with applications greater than 2000 V.



Metric Conductor, Two-Hole, Standard Barrel with Window Lug (continued)



Part Number	Copper Conductor Size Class 2 (mm ²)	Current Rating (Amps)	Stud Hole Size (mm)	Stud Hole Spacing (In.)	Figure Dimensions (mm)						PANDUIT Die Index No.‡	Std. Pkg. Qty.
					ØI	B	M	N	L	ØD		
LCMD185-10CD-X	185	—	M10	22.0 – 25.0	18.6	33.5	16.5	17.0	97.5	11.0	P76	10
LCMD185-12-X	185	—	M12	44.5	18.6	33.5	16.5	17.5	117.0	14.0	P76	10
LCMD185-14-X	185	—	M14	44.5	18.6	33.5	21.0	17.5	121.5	16.0	P76	10
LCMD185-00-X*	185	—	Blank	—	18.6	33.5	—	—	121.5	—	P76	10
LCMD240-10CD-5	240	—	M10	22.0 – 25.0	20.8	37.5	21.0	19.0	111.5	11.0	P87	5
LCMD240-12-5	240	—	M12	44.5	20.8	37.5	21.0	19.5	131.0	14.0	P87	5
LCMD240-14-5	240	—	14	44.5	20.8	37.5	21.0	19.5	131.0	16.0	P87	5
LCMD240-00-5*	240	—	Blank	—	20.8	37.5	—	—	131.0	—	P87	5
LCMD300-12-5	300	—	M12	44.5	23.5	42.5	22.0	20.0	139.0	14.0	P94	5
LCMD300-14-5	300	—	M14	44.5	23.5	42.5	22.0	20.0	139.0	16.0	P94	5
LCMD300-00-5*	300	—	Blank	—	23.5	42.5	—	—	139.0	—	P94	5
LCMD400-12-5	400	—	M12	44.5	27.0	49.5	26.5	23.5	151.5	14.0	P106	5
LCMD400-14-5	400	—	M14	44.5	27.0	49.5	26.5	23.5	151.5	16.0	P106	5
LCMD400-16-5	400	—	M16	44.5	27.0	49.5	26.5	23.5	151.5	18.0	P106	5
LCMD400-00-5*	400	—	Blank	—	27.0	49.5	—	—	151.5	—	P106	5
LCMD500-12-1	500	—	M12	44.5	31.0	57.5	28.5	25.5	164.5	14.0	P125	1
LCMD500-14-1	500	—	M14	44.5	31.0	57.5	28.5	25.5	164.5	16.0	P125	1
LCMD500-16-1	500	—	M16	44.5	31.0	57.5	28.5	25.5	164.5	18.0	P125	1
LCMD500-00-1*	500	—	Blank	—	31.0	57.5	—	—	164.5	—	P125	1
LCMD630-12-1	630	—	M12	44.5	34.5	63.0	28.5	27.5	175.5	14.0	P125	1
LCMD630-14-1	630	—	M14	44.5	34.5	63.0	28.5	27.5	175.5	16.0	P125	1
LCMD630-16-1	630	—	M16	44.5	34.5	63.0	28.5	27.5	175.5	18.0	P125	1
LCMD630-00-1*	630	—	Blank	—	34.5	63.0	—	—	175.5	—	P125	1

‡See page D3.79 for tool and die information.

*UL Recognized only.

**Consult cable manufacturer for voltage stress relief instructions with applications greater than 2000 V.

A. System Overview

B1. Cable Ties

B2. Cable Accessories

B3. Stainless Steel Ties

C1. Wiring Duct

C2. Surface Raceway

C3. Abrasion Protection

C4. Cable Management

D1. Terminals

D2. Power Connectors

D3. Grounding Connectors

E1. Labeling Systems

E2. Labels

E3. Pre-Printed & Write-On Markers

E4. Permanent Identification

E5. Lockout/Tagout & Safety Solutions

F. Index

A.
System
Overview



Metric Conductor, Standard Barrel, Butt Splice

For Use with Class 2 Stranded Copper Conductors

B1.
Cable Ties

Type SCMS

- Tin-plated to inhibit corrosion
- UL Listed, UL Recognized, and CSA Certified to 35 KV** and temperature rated to 90°C when crimped with *PANDUIT* tools and dies
- Product information marked on connector for selection and installation
- Internally beveled wire entry for fast and easy installation

B2.
Cable
Accessories

B3.
Stainless
Steel Ties

C1.
Wiring
Duct

C2.
Surface
Raceway

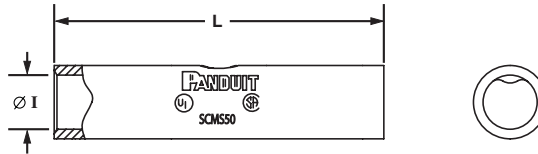

C3.
Abrasion
Protection

C4.
Cable
Management

Part Number	Copper Conductor Size Class 2 (mm ²)	Current Rating (Amps)	Figure Dimensions (mm)		PANDUIT Die Index No.‡	Std. Pkg. Qty.
			ØI	L		
SCMS10-C	10	—	4.5	30.0	P21	100
SCMS16-C*	16	65	5.5	35.0	P24	100
SCMS25-L	25	—	6.9	36.0	P29	50
SCMS35-L	35	—	8.2	36.0	P33	50
SCMS50-L	50	—	9.8	49.0	P42	50
SCMS70-L	70	—	11.5	52.0	P45	50
SCMS95-Q	95	—	13.5	54.0	P54	25
SCMS120-Q	120	—	15.2	57.0	P62	25
SCMS150-X	150	—	16.5	57.0	P66	10
SCMS185-X	185	—	18.6	61.0	P76	10
SCMS240-X	240	—	20.8	72.0	P87	10
SCMS300-5	300	—	23.5	75.0	P94	5
SCMS400-5	400	—	27.0	95.0	P106	5
SCMS500-6	500	—	31.0	96.0	P125	6
SCMS630-6	630	—	34.5	131.0	P125	6

‡See page D3.79 for tool and die information.

*UL Recognized only.

**Consult cable manufacturer for voltage stress relief instructions with applications greater than 2000 V.

E1.
Labeling
Systems

E2.
Labels

E3.
Pre-Printed
& Write-On
Markers

E4.
Permanent
Identification

E5.
Lockout/
Tagout/
& Safety
Solutions

F.
Index

PANDUIT Custom Copper Compression Lugs for Special Applications

Manufactured to meet your special dimensional specifications and requirements

PANDUIT has incorporated manufacturing processes that permit custom lug capabilities with premium two day or standard two week delivery. PANDUIT offers a wide variety of dimensional choices for #8 AWG to 250 kcmil copper code lugs and #8 AWG to 4/0 AWG copper flex lugs.

Options:

Tongues – Straight or bent
 – Stacking
 – Special lengths

Stud Holes – Various sizes, #10 to 1/2"
 – Multiple hole sizes and spacing
 – Special locations

Barrels – Three standard lengths: short, standard, and long
 – Custom lengths

With Dependable PANDUIT Service

- Excellent quality
- Fast delivery
- Low minimum order quantities
- Competitive prices

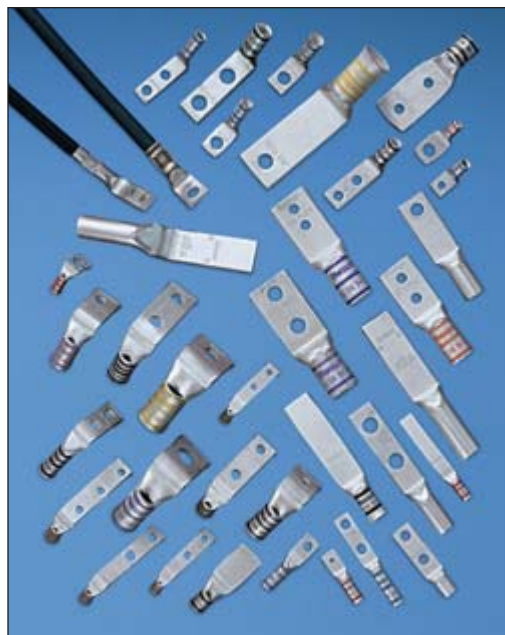

A.
System
Overview

B1.
Cable Ties

B2.
Cable
Accessories

B3.
Stainless
Steel Ties

C1.
Wiring
Duct

C2.
Surface
Raceway

C3.
Abrasion
Protection

C4.
Cable
Management

D1.
Terminals

D2.
Power
Connectors

D3.
Grounding
Connectors

E1.
Labeling
Systems

E2.
Labels

E3.
Pre-Printed
& Write-On
Markers

E4.
Permanent
Identification

E5.
Lockout/
Tagout
& Safety
Solutions

F.
Index

Custom Lugs Spec Sheet Instructions

Use these instructions to design your own custom lugs. Fill in the Custom Lugs Preliminary Spec Sheet to place your custom lugs order. You can copy the sheet from page D2.115 or download it at www.panduit.com/customlugs.

- Fill out this section completely.
 - Check the conductor size and type (code or flex). Fill in the strand designation and type for flex conductor.
 - Check a barrel length. Refer to Chart "A" for standard barrel length dimensions. If the length you require is not listed, fill in the special box with your required length.
 - Check "YES" if an inspection window is required; check "NO" if it is not required.
 - Check the barrel end type you require.
 - Check a stud size and tongue style (one-hole, two-hole, or blank). Refer to Chart "A" and Chart "B" for standard tongue dimensions. If you require tongue dimensions other than those listed, fill in the box that corresponds to the feature that requires a special dimension. You must fill in a hole spacing on two-hole lugs and tongue length on blank tongue lugs.
- Note: Steps 7 and 8 are for bent or stacking lugs ONLY.**
- Check the stacking lug you require. If both upper and lower lugs are required, check "both" (two drawings will be provided). If you choose a bent stacking lug, fill in the required angle.
 - Check the bent lug you require. If you check "special angle", fill in the required angle.
 - Check the special options you require. Fill in any blank lines that correspond to the option you've selected.
 - Fax or mail the completed spec sheet to PANDUIT Corp. Phone/fax numbers are listed on the bottom of the Custom Lugs Preliminary Spec Sheet (see page D2.115 or go to www.panduit.com/customlugs). PANDUIT will send drawings for your approval.

Chart "A"

Code Conductor Size	Flex Conductor Size	Barrel		Barrel Length			Tongue Width				
		I.D.	O.D.	Short	Standard	Long	Nominal Stud Size				
							#10	1/4	5/16	3/8	1/2
#8	—	.18	.27	.42	.56	.70	.41	.48	.56	.60	—
#6	#6 AWG	.22	.31	.48	.81	1.07	.45	.48	.56	.62	—
#4	#4 AWG	.28	.38	.53	.81	1.05	.55		.62	—	
#2	—	.31	.42	.57	.88	1.16	.60		.66	.75	
#1	#2 AWG	.36	.47	.59	.88	1.36	.70			.75	
1/0	#1 AWG	.39	.52	.66	.94	1.44	.76			.80	
2/0	1/0 AWG	.45	.58	.72	.98	1.50	.85				
3/0	2/0 AWG	.51	.64	.83	1.14	1.50	.96				
4/0	3/0 AWG	.57	.71	.91	1.19	1.56	1.06				
250	4/0 AWG	.63	.77	1.03	1.25	1.61	1.17				

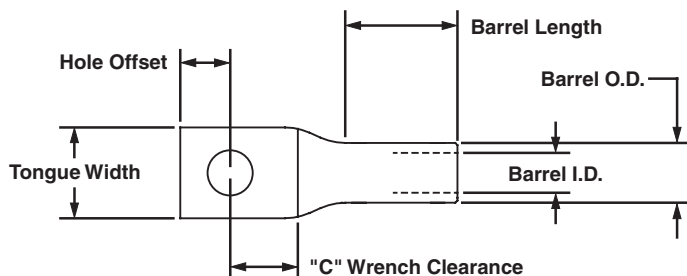





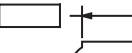
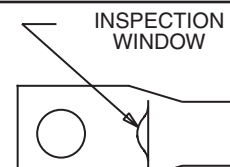

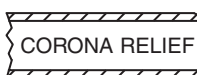

Chart "B"

Nominal Stud Size	Actual Hole Size	Minimum Hole Offset	Minimum "C" Wrench Size
#10	.20	.23	.31
1/4"	.27	.25	.38
5/16"	.34	.32	.38
3/8"	.41	.38	.44
1/2"	.53	.50	.56
5/8"	.69	.63	.69
3/4"	.81	.75	.75

Custom Lugs Preliminary Spec Sheet



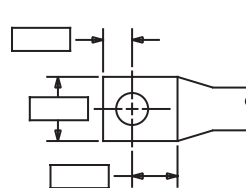
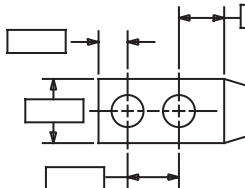
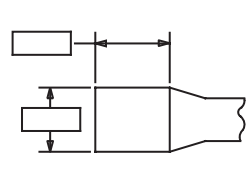

Photocopy this form to place your order. This form is also available at www.panduit.com/customlugs.
Mail or fax the photocopy to receive drawings and quotation. Place your order through your local PANDUIT distributor.

1 CUSTOMER PROFILE			
Company Name _____		City/State _____	
Address _____			
Your Name _____		Phone Number _____	
Fax Number _____		Quantity Required _____ Delivery Date _____	

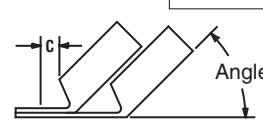
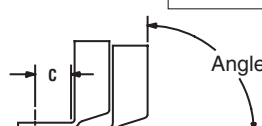
2 CONDUCTOR <input type="checkbox"/> #8 <input type="checkbox"/> #6 <input type="checkbox"/> #4 <input type="checkbox"/> #2 <input type="checkbox"/> #1 <input type="checkbox"/> 1/0 <input type="checkbox"/> 2/0 <input type="checkbox"/> 3/0 <input type="checkbox"/> 4/0 <input type="checkbox"/> 250 kcmil <input type="checkbox"/> Special <hr/> <input type="checkbox"/> Code <input type="checkbox"/> Flex { Strands _____ Type _____	3 BARREL LENGTH <input type="checkbox"/>  SHORT <input type="checkbox"/>  STANDARD <input type="checkbox"/>  LONG <input type="checkbox"/>  SPECIAL	4 INSPECTION WINDOW  <input type="checkbox"/> YES <input type="checkbox"/> NO	5 BARREL END TYPE <input type="checkbox"/>  STANDARD <input type="checkbox"/>  CORONA RELIEF <input type="checkbox"/>  FLARED
---	--	--	--

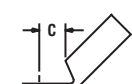
6 TONGUE SPECIFICATIONS (Standard Dimensions apply to boxes left blank – See Charts “A” and “B”)			
Stud Sizes <input type="checkbox"/> #10 <input type="checkbox"/> 1/4 <input type="checkbox"/> 5/16 <input type="checkbox"/> 3/8 <input type="checkbox"/> 1/2 <input type="checkbox"/> Other _____	<input type="checkbox"/>  <input type="checkbox"/> One-Hole	<input type="checkbox"/>  <input type="checkbox"/> Two-Hole	<input type="checkbox"/>  <input type="checkbox"/> Blank

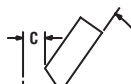
7 STACKING LUG SELECTION (If not needed – proceed to Step 8)			
Lugs With 0° to 45° Angles			
<input type="checkbox"/> Upper Bent _____ Angle  <input type="checkbox"/> Both <input type="checkbox"/> Lower Bent _____ Angle	<input type="checkbox"/> Upper Bent _____ Angle  <input type="checkbox"/> Lower Bent _____ Angle		

8 BENT LUG SELECTION (If not needed – proceed to Step 9)			
<input type="checkbox"/>  45° <input type="checkbox"/>  90°	<input type="checkbox"/> SPECIAL ANGLE _____ <input type="checkbox"/> SPECIAL ANGLE _____	<input type="checkbox"/>  45° <input type="checkbox"/>  90°	

9 SPECIAL OPTIONS FEATURES	
<input type="checkbox"/> Part I.D. on Tongue	<input type="checkbox"/> PANDUIT P/N
Custom P/N: _____	
<input type="checkbox"/> No Barrel Markings	
<input type="checkbox"/> Special Plating (TIN STD): _____	
<input type="checkbox"/> Special Packaging _____	
<input type="checkbox"/> Other _____	

10 FAX DIRECTIONS	
Fax to PANDUIT Corp. PHONE: 888-506-5400 Ext. 2241 FAX: 815-485-5839 ATTN: Product Management	
CONTACT FACTORY FOR MINIMUM ORDER	

A. System Overview

B1. Cable Ties

B2. Cable Accessories

B3. Stainless Steel Ties

C1. Wiring Duct

C2. Surface Raceway

C3. Abrasion Protection

C4. Cable Management

D1. Terminals

D2. Power Connectors

D3. Grounding Connectors

E1. Labeling Systems

E2. Labels

E3. Pre-Printed & Write-On Markers

E4. Permanent Identification

E5. Lockout/Tagout & Safety Solutions

F. Index

A. System Overview

B1. Cable Ties

B2. Cable Accessories

B3. Stainless Steel Ties

C1. Wiring Duct

C2. Surface Raceway

C3. Abrasion Protection

C4. Cable Management

D1. Terminals

D2. Power Connectors

D3. Grounding Connectors

E1. Labeling Systems

E2. Labels

E3. Pre-Printed & Write-On Markers

E4. Permanent Identification

E5. Lockout/Tagout & Safety Solutions

F. Index

UL LISTED **CSA CERTIFIED** **Code Conductor, One-Hole, Aluminum Lug**

For Use with Stranded Aluminum or Copper Code Conductors

Type LAA

- Manufactured from high conductivity thick wall wrought aluminum
- Enclosed barrel prevents corrosive material from entering barrel when used in harsh environments
- Factory pre-filled with joint compound and sealed with easy pull-out end plug to inhibit corrosion
- Tin-plated to inhibit corrosion
- Color-coded end plug and *PANDUIT* and specified competitor die index numbers marked on barrel for proper crimp die selection
- UL Listed and CSA Certified to 35 KV** and temperature rated to 90°C when crimped with *PANDUIT* and specified competitor crimping tools and dies

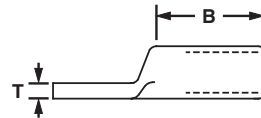
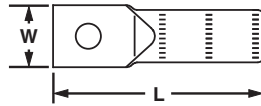

Part Number	Aluminum or Copper Conductor Size	Stud Hole Size (In.)	Figure Dimensions (In.)				<i>PANDUIT</i> Color Code	<i>PANDUIT</i> Die Index No.‡	Burdny Die Index No.‡	T&B Die Index No.‡	Wire Strip Length (In.)	Std. Pkg. Qty.
			W	B	T	L						
LAA6-14-X	#6 AWG	1/4	.55	.86	.11	2.20	Gray	P29	346	29	1	10
LAA6-56-X		5/16	.55	1.00	.11	2.20	Gray	P29	346	29	1	10
LAA4-14-X	#4 AWG	1/4	.66	1.05	.19	2.05	Green	P37	375	37	1 1/16	10
LAA4-56-X		5/16	.69	1.08	.16	2.23	Green	P37	375	37	1 1/16	10
LAA4-38-X	#2 AWG	3/8	.69	.92	.16	2.33	Green	P37	375	37	1 1/16	10
LAA2-14-X		1/4	.75	.98	.17	2.63	Pink	P42	348	42	1	10
LAA2-56-X	5/16	.75	.98	.17	2.63	Pink	P42	348	42	1	10	
LAA2-38-X	#1 AWG	3/8	.75	.98	.17	2.63	Pink	P42	348	42	1	10
LAA1-14-X		1/4	.75	.98	.17	2.63	Gold	P45	471	45	1	10
LAA1-56-X	5/16	.75	.98	.17	2.63	Gold	P45	471	45	1	10	
LAA1-38-X	1/0 AWG	3/8	.75	.98	.17	2.63	Gold	P45	471	45	1	10
LAA1/0-56-X		5/16	.88	1.30	.25	3.23	Tan	P50	296	50	1 9/16	10
LAA1/0-38-X	3/8	.88	1.30	.25	3.23	Tan	P50	296	50	1 9/16	10	
LAA1/0-12-X	2/0 AWG	1/2	.88	1.30	.25	3.23	Tan	P50	296	50	1 9/16	10
LAA2/0-38-5		3/8	.95	1.31	.23	3.19	Olive	P54	297	54	1 9/16	5
LAA2/0-12-5	1/2	.95	1.30	.23	3.19	Olive	P54	297	54	1 9/16	5	
LAA3/0-38-5	3/0 AWG	3/8	1.07	1.50	.25	3.44	Ruby	P60	467	60	1 9/16	5
LAA3/0-12-5		1/2	1.07	1.50	.25	3.44	Ruby	P60	467	60	1 9/16	5
LAA4/0-38-5	4/0 AWG	3/8	1.19	1.44	.32	3.56	White	P66	298	66	1 3/4	5
LAA4/0-12-5		1/2	1.19	1.44	.32	3.56	White	P66	298	66	1 3/4	5
LAA250-38-5	250 kcmil	3/8	1.24	1.56	.30	3.63	Red	P71	324	71	1 9/16	5
LAA250-12-5		1/2	1.24	1.56	.30	3.63	Red	P71	324	71	1 9/16	5
LAA300-38-2	300 kcmil	3/8	1.38	2.25	.34	4.05	Blue	P76	470	76	2 5/16	2
LAA300-12-2		1/2	1.38	2.25	.34	4.05	Blue	P76	470	76	2 5/16	2
LAA350-12-2	350 kcmil	1/2	1.50	2.25	.38	4.30	Brown	P87	299	87	2 5/16	2
LAA400-58-2	400 kcmil	5/8	1.61	2.50	.41	4.92	Green	P94	472	94	2 9/16	2
LAA500-12-2	500 kcmil	1/2	1.75	3.00	.44	5.56	Pink	P99	300	99	3 1/16	2
LAA500-58-2		5/8	1.75	3.00	.44	5.56	Pink	P99	300	99	3 1/16	2
LAA750-58-1	750 kcmil	5/8	1.75	3.38	.53	6.55	Red	P125	301	115	3 7/16	1
LAA1000-58-1	1000 kcmil	5/8	2.56	4.50	.61	7.38	Brown	P161	302	161	4 3/4	1

‡See pages D3.80, D3.81 for tool and die information.

**Consult cable manufacturer for voltage stress relief instructions with applications greater than 2000 V.

See page D2.123 for *PANDUIT* joint compounds recommended for pad to pad and conductor connections.



Code Conductor, Two-Hole, Aluminum Lug

For Use with Stranded Aluminum or Copper Code Conductors

Type LAB

- Manufactured from high conductivity thick wall wrought aluminum
- Factory pre-filled with joint compound and sealed with easy pull-out end plug to inhibit corrosion
- Color-coded end plug and *PANDUIT* and specified competitor die index numbers marked on barrel for proper crimp die selection
- Enclosed barrel prevents corrosive material from entering barrel when used in harsh environments
- Tin-plated to inhibit corrosion
- UL Listed and CSA Certified to 35 KV** and temperature rated to 90°C when crimped with *PANDUIT* and specified competitor crimping tools and dies
- Available with NEMA hole sizes and spacing

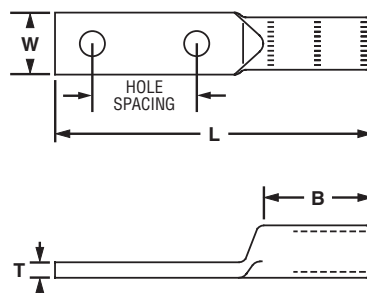

Part Number	Aluminum or Copper Conductor Size	Stud Hole Size (In.)	Stud Hole Spacing (In.)	Figure Dimensions (In.)				PANDUIT Color Code	PANDUIT Die Index No.‡	Burdny Die Index No.‡	T&B Die Index No.‡	Wire Strip Length (In.)	Std. Pkg. Qty.
				W	B	T	L						
LAB1/0-38-X	1/0 AWG	3/8	1.75	.88	1.55	.25	5.33	Tan	P50	296	50	1 9/16	10
◆ LAB2/0-12-5	2/0 AWG	1/2	1.75	.94	1.55	.27	5.55	Olive	P54	297	54	1 9/16	5
◆ LAB3/0-12-5	3/0 AWG	1/2	1.75	1.03	1.55	.27	5.55	Ruby	P60	467	60	1 9/16	5
◆ LAB4/0-12-5	4/0 AWG	1/2	1.75	1.19	1.80	.31	5.98	White	P66	298	66	1 3/4	5
◆ LAB250-12-5	250 kcmil	1/2	1.75	1.25	1.80	.31	6.05	Red	P71	324	71	1 3/4	5
◆ LAB300-12-2	300 kcmil	1/2	1.75	1.36	2.30	.34	6.61	Blue	P76	470	76	2 5/16	2
◆ LAB350-12-2	350 kcmil	1/2	1.75	1.50	2.30	.38	6.61	Brown	P87	299	87	2 5/16	2
◆ LAB400-12-2	400 kcmil	1/2	1.75	1.66	2.55	.38	6.92	Green	P94	472	94	2 9/16	2
◆ LAB500-12-2	500 kcmil	1/2	1.75	1.72	3.05	.44	7.36	Pink	P99	300	99	3 1/16	2
◆ LAB600-12-2	600 kcmil	1/2	1.75	1.72	3.05	.50	7.55	Black	P106	473	106	3 1/16	2
◆ LAB750-12-1	750 kcmil	1/2	1.75	1.72	3.42	.56	8.30	Red	P125	301	115	3 7/16	1
◆ LAB800-12-1	800 kcmil	1/2	1.75	1.72	3.42	.59	8.30	Gray	P140	474	125	3 7/16	1
◆ LAB1000-12-1	1000 kcmil	1/2	1.75	2.56	4.67	.63	9.67	Brown	P161	302	161	4 3/4	1

‡See pages D3.80, D3.81 for tool and die information.

**Consult cable manufacturer for voltage stress relief instructions with applications greater than 2000 V.

See page D2.123 for *PANDUIT* joint compounds recommended for pad to pad and conductor connections.

◆NEMA hole sizes and spacing.

A. System Overview

B1. Cable Ties

B2. Cable Accessories

B3. Stainless Steel Ties

C1. Wiring Duct

C2. Surface Raceway

C3. Abrasion Protection

C4. Cable Management

D1. Terminals

D2. Power Connectors

D3. Grounding Connectors

E1. Labeling Systems

E2. Labels

E3. Pre-Printed & Write-On Markers

E4. Permanent Identification

E5. Lockout/Tagout & Safety Solutions

F. Index

A.
System
Overview

Belleville Compression Washers

B1.
Cable Ties

Type CW

• Conical spring washer for use when assembling aluminum connectors to copper and/or steel pads, compensates for differing rates of thermal expansion to keep hardware assembly from loosening

- For assembly information, see page D2.164
- Made from hardened steel to provide high strength
- Cadmium-plated to inhibit corrosion

B2.
Cable
Accessories



B3.
Stainless
Steel Ties

C1.
Wiring
Duct

Part Number	Stud Hole Size (In.)	Figure Dimensions (In.)			Std. Pkg. Qty.
		D	H	T	
CW-14-L	1/4	.68	.09	.05	50
CW-56-L	5/16	.81	.08	.06	50
CW-38-L	3/8	.93	.10	.07	50
CW-12-Q	1/2	1.18	.12	.09	25
CW-58-Q	5/8	1.49	.15	.12	25

C2.
Surface
Raceway

C3.
Abrasion
Protection

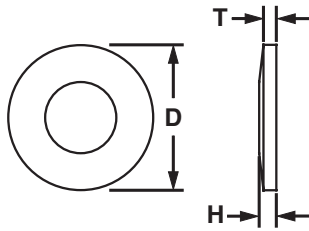

C4.
Cable
Management

D1.
Terminals

D2.
Power
Connectors

D3.
Grounding
Connectors

E1.
Labeling
Systems

E2.
Labels

E3.
Pre-Printed
& Write-On
Markers

E4.
Permanent
Identification

E5.
Lockout/
Tagout/
& Safety
Solutions

F.
Index



Code Conductor, Aluminum Splice

For Use with Stranded Aluminum-to-Aluminum or Copper-to-Copper Conductors

Type SA

- Manufactured from high conductivity thick wall wrought aluminum
- Factory pre-filled with joint compound and sealed with easy pull-out end plug to inhibit corrosion
- Color-coded end plugs and *PANDUIT* and specified competitor die index numbers marked on barrel for proper crimp die selection
- Tin-plated to inhibit corrosion
- Internal solid center prevents over-insertion of conductor
- UL Listed and CSA Certified to 35 KV** and temperature rated to 90°C when crimped with *PANDUIT* and specified competitor crimping tools and dies

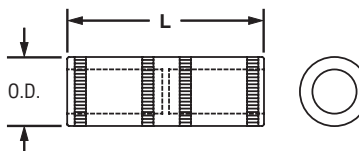

Part Number	Aluminum or Copper Conductor Size	Figure Dimensions (In.)		PANDUIT Color Code	PANDUIT Die Index No.‡	Burndy Die Index No.‡	T&B Die Index No.‡	Wire Strip Length (In.)	Std. Pkg. Qty.
		Barrel O.D.	L						
SA6-X	#6 AWG	.34	1.62	Gray	P29	346	29	3/4	10
SA4-X	#4 AWG	.48	2.13	Green	P37	375	37	7/8	10
SA2-X	#2 AWG	.53	2.00	Pink	P42	348	45	7/16	10
SA1-X	#1 AWG	.53	2.00	Gold	P45	471	45	7/16	10
SA1/0-X	1/0 AWG	.64	2.12	Tan	P50	296	50	1	10
SA2/0-5	2/0 AWG	.69	2.31	Olive	P54	297	54	1 1/8	5
SA3/0-5	3/0 AWG	.76	2.62	Ruby	P60	467	60	1 1/4	5
SA4/0-5	4/0 AWG	.88	2.75	White	P66	298	66	1 5/16	5
SA250-5	250 kcmil	.91	2.94	Red	P71	324	71	1 7/16	5
SA300-2	300 kcmil	1.01	3.12	Blue	P76	470	76	1 1/2	2
SA350-2	350 kcmil	1.12	3.37	Brown	P87	299	87	1 5/8	2
SA400-2	400 kcmil	1.19	3.75	Green	P94	472	94	1 13/16	2
SA500-2	500 kcmil	1.32	3.87	Pink	P99	300	99	1 7/8	2
SA600-2	600 kcmil	1.44	4.12	Black	P106	473	106	2	2
SA750-1	750 kcmil	1.60	4.62	Red	P125	301	115	2 1/4	1
SA800-1	800 kcmil	1.66	4.75	Gray	P140	474	125	2 5/16	1
SA1000-1	1000 kcmil	1.84	5.25	Brown	P161	302	161	2 9/16	1

‡See pages D3.80, D3.81 for tool and die information.

**Consult cable manufacturer for voltage stress relief instructions with applications greater than 2000 V.

See page D2.123 for *PANDUIT* joint compounds recommended for pad to pad and conductor connections.

A. System Overview

B1. Cable Ties

B2. Cable Accessories

B3. Stainless Steel Ties

C1. Wiring Duct

C2. Surface Raceway

C3. Abrasion Protection

C4. Cable Management

D1. Terminals

D2. Power Connectors

D3. Grounding Connectors

E1. Labeling Systems

E2. Labels

E3. Pre-Printed & Write-On Markers

E4. Permanent Identification

E5. Lockout/Tagout & Safety Solutions

F. Index

A.
System
Overview

Code Conductor, Aluminum, Reducing Splice

B1.
Cable Ties

For Reducing Stranded Aluminum-to-Aluminum or Aluminum-to-Copper Conductors

Type SAR

B2.
Cable
Accessories

- Dual rated for use with aluminum or copper conductors
- Tin-plated to inhibit corrosion
- Factory pre-filled with joint compound and sealed with easy pull-out end plug to inhibit corrosion
- For use up to 35 KV** and temperature rated 90°C when crimped with *PANDUIT* and specified competitor crimping tools and dies
- Color-coded end plug and *PANDUIT* and specified competitor die index numbers marked on barrel for proper crimp die selection

B3.
Stainless
Steel Ties



C1.
Wiring
Duct

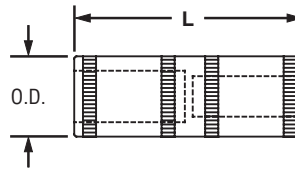

C2.
Surface
Raceway

C3.
Abrasion
Protection

Part Number	Aluminum Conductor Size From	Aluminum or Copper Conductor Size To	Figure Dimensions (In.)		PANDUIT Color Code	PANDUIT Die Index No.‡	Burndy Die Index No.‡	T&B Die Index No.‡	Wire Strip Length (In.)	Std. Pkg. Qty.
			Barrel O.D.	L						
SAR2-4-X	#2 AWG	#4 AWG	.64	4.25	Tan	P50	296	50	2 1/16	10
SAR1/0-2-X	1/0 AWG	#2 AWG	.64	4.25	Tan	P50	296	50	2 1/16	10
SAR3/0-1/0-5	3/0 AWG	1/0 AWG	.91	4.98	Red	P71	324	71	2 5/16	5
SAR4/0-2/0-5	4/0 AWG	2/0 AWG	.91	5.24	Red	P71	324	71	2 3/16	5
SAR350-4/0-2	350 kcmil	4/0 AWG	1.12	6.63	Brown	P87	299	87	3 3/16	2
SAR500-350-2	500 kcmil	350 kcmil	1.32	8.60	Pink	P99	300	99	4 1/4	2
SAR600-500-2	600 kcmil	500 kcmil	1.49	9.25	Black	P106	473	106	4	2
SAR750-600-2	750 kcmil	600 kcmil	1.60	9.88	Red	P125	301	115	4 7/16	2

‡See pages D3.82 – D3.83 for tool and die information.

**Consult cable manufacturer for voltage stress relief instructions with applications greater than 2000 V.

See page D2.123 for *PANDUIT* joint compounds recommended for pad to pad and conductor connections.

D1.
Terminals

D2.
Power
Connectors

D3.
Grounding
Connectors

E1.
Labeling
Systems

E2.
Labels

E3.
Pre-Printed
& Write-On
Markers

E4.
Permanent
Identification

E5.
Lockout/
Tagout/
& Safety
Solutions

F.
Index

UL LISTED Code Conductor, Aluminum, Bi-Metallic Pin Connector

Provides Copper Pigtail for Connecting Aluminum Conductors to a Copper or Aluminum/Copper Rated Mechanical Lug

Type BPC

- Factory pre-filled with joint compound and sealed with easy pull-out end plug to inhibit corrosion
- Color-coded end plug and *PANDUIT* die index number marked on barrel for proper crimp die selection
- Insulating rubber sleeve included to insulate aluminum barrel from contact with copper connector when attached to pin

- Tin-plated to inhibit corrosion
- UL Listed per UL 486B; temperature rated 90°C and for use up to 600 V when crimped with *PANDUIT* and specified competitor crimping tools and dies

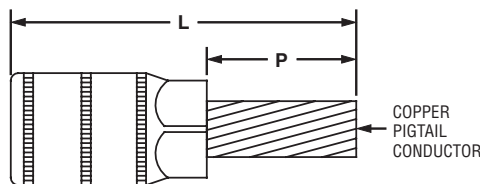

Part Number	Aluminum Conductor Size	Copper Pigtail Size	Figure Dimensions (In.)		PANDUIT Color Code	PANDUIT Die Index No.‡	Burdny Die Index No.‡	T&B Die Index No.‡	Wire Strip Length (In.)	Std. Pkg. Qty.
			L	P						
BPC6-L	#6 AWG	#8 AWG	2.45	.88	Tan	P50	296	50	1 1/16	50
BPC4-L	#4 AWG	#6 AWG	2.45	.88	Tan	P50	296	50	1 1/16	50
BPC2-L	#2 AWG	#4 AWG	2.45	.88	Tan	P50	296	50	1 1/16	50
BPC1-X	#1 AWG	#3 AWG	2.58	1.00	Tan	P50	296	50	1 1/16	10
BPC1/0-X	1/0 AWG	#2 AWG	3.33	1.25	Red	P71	298	76	1 5/16	10
BPC2/0-X	2/0 AWG	#1 AWG	3.33	1.25	Red	P71	298	76	1 5/16	10
BPC3/0-X	3/0 AWG	1/0 AWG	3.46	1.38	Red	P71	298	76	1 5/16	10
BPC4/0-X	4/0 AWG	2/0 AWG	3.46	1.38	Red	P71	298	76	1 5/16	10
BPC250-X	250 kcmil	3/0 AWG	3.71	1.50	Green	P94	299	99,87	1 7/16	10
BPC300-X	300 kcmil	4/0 AWG	4.10	1.63	Green	P94	299	99,87	1 7/16	10
BPC350-X	350 kcmil	4/0 AWG	4.10	1.63	Green	P94	299	99,87	1 7/16	10
BPC400-X	400 kcmil	250 kcmil	4.35	1.88	Black	P106	300	106	1 7/16	10
BPC500-X	500 kcmil	350 kcmil	4.35	1.88	Black	P106	300	106	1 7/16	10
BPC600-6	600 kcmil	350 kcmil	4.77	1.88	Red	P125	936	115	1 15/16	6
BPC750-6	750 kcmil	500 kcmil	4.90	2.00	Red	P125	936	115	1 15/16	6

‡See pages D3.84 – D3.85 for tool and die information.
See page D2.123 for *PANDUIT* joint compounds recommended for pad to pad and conductor connections.

A. System Overview

B1. Cable Ties

B2. Cable Accessories

B3. Stainless Steel Ties

C1. Wiring Duct

C2. Surface Raceway

C3. Abrasion Protection

C4. Cable Management

D1. Terminals

D2. Power Connectors

D3. Grounding Connectors

E1. Labeling Systems

E2. Labels

E3. Pre-Printed & Write-On Markers

E4. Permanent Identification

E5. Lockout/Tagout & Safety Solutions

F. Index

A.
System
Overview

Code Conductor, Aluminum HTAP

B1.
Cable Ties

For Combinations of Aluminum-to-Aluminum or Aluminum-to-Copper Code Conductors

Type HTAP

B2.
Cable
Accessories

- Dual rated – used to tap into continuous runs of aluminum conductor with either aluminum or copper tap conductor
- Factory pre-filled with joint compound to inhibit corrosion
- Conductor range for each tap groove and die index number marked on barrel to identify proper conductor size and crimping die to be used
- Made from high conductivity, high strength aluminum to provide premium mechanical and electrical performance
- For use up to 600 V and 90°C temperature rated when crimped with *PANDUIT* crimping tools and dies

B3.
Stainless
Steel Ties



C1.
Wiring
Duct

C2.
Surface
Raceway

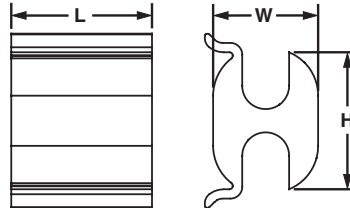

C3.
Abrasion
Protection

C4.
Cable
Management

Part Number	Conductor Size		Figure Dimensions (In.)			PANDUIT Die Index No.‡	Wire Strip Length (In.)	Std. Pkg. Qty.
	Run	Tap	L	W	H			
HTAP2-8-L	#2 – 6 AWG STR or #1 – 6 AWG SOL	#8 – 14 AWG STR or #7 – 14 AWG SOL	.75	.56	.73	P50	7/8	50
HTAP1-1-Q	#1 – 6 AWG STR or #2 – 6 AWG SOL	#1 – 6 AWG STR or #2 – 6 AWG SOL	1.50	.70	1.10	P0	1 5/8	25
HTAP1/0-1-Q	1/0 – 6 AWG STR or #2 – 6 AWG SOL	#1 – 6 AWG STR or #2 – 6 AWG SOL	1.50	.70	1.17	P0	1 5/8	25
HTAP2/0-1-Q	2/0 – 2 AWG STR or #2 – 6 AWG SOL	#1 – 6 AWG STR or #2 – 6 AWG SOL	1.50	.70	1.17	P0	1 5/8	25
HTAP3/0-1-Q	3/0 – 1/0 AWG STR or 4/0 – 3/0 AWG SOL	#1 – 6 AWG STR or #2 – 6 AWG SOL	1.50	.88	1.39	PD or PD3	1 5/8	25
HTAP3/0-3/0-Q	3/0 – 1/0 AWG STR or 4/0 – 3/0 AWG SOL	3/0 – 1/0 AWG STR or 4/0 – 3/0 AWG SOL	1.88	.90	1.48	PD or PD3	2	25
HTAP4/0-2-Q	4/0 – 3/0 AWG STR	#1 – 6 AWG STR or #2 – 6 AWG SOL	1.50	.88	1.38	PD or PD3	1 5/8	25
HTAP4/0-3/0-Q	4/0 – 3/0 AWG STR	3/0 – 1 AWG STR	2.25	.90	1.44	PD or PD3	2 3/8	25
HTAP4/0-4/0-Q	4/0 – 3/0 AWG STR	4/0 – 3/0 AWG STR	2.50	.90	1.38	PD or PD3	2 5/8	25
HTAP500-500-X	500 kcmil – 4/0 AWG STR	500 kcmil – 4/0 AWG STR	4.50	1.20	1.88	PN	4 5/8	10
HTAP500-4/0-X	500 kcmil – 4/0 AWG STR	4/0 – 1/0 AWG STR	2.75	1.20	1.88	PN	2 7/8	10

‡See page D3.86 for tool and die information.

See page D2.123 for type TAPC HTAP covers.

See page D2.123 for *PANDUIT* joint compounds recommended for pad to pad and conductor connections.

E1.
Labeling
Systems

E2.
Labels

E3.
Pre-Printed
& Write-On
Markers

E4.
Permanent
Identification

E5.
Lockout/
Tagout/
& Safety
Solutions

F.
Index

Black Covers for Copper CTAPs and Aluminum HTAPs

Protect CTAP or HTAP Connection from Environment And Act as Insulation

Type TAPC

- Used to insulate connectors and protect tap connections from corrosive environments
- Made of durable, weather-resistant black polypropylene
- Double locking latches provide secure cover installation
- Flexible molded fingers at end of covers conform to conductor and prevent foreign objects from contacting connector

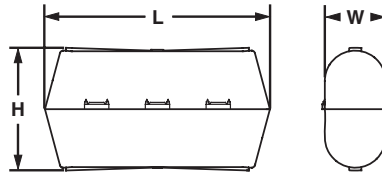

Part Number	Use with CTAP Part Number	Use with HTAP Part Number	Figure Dimensions (In.)			Std. Pkg. Qty.
			L	W	H	
TAPC2-2/0-X	CTAP 4-6, CTAP 4-4, CTAP 2-4, CTAP 2-2	HTAP 1-1, HTAP 1/0-1, HTAP 2-8, HTAP 2/0-1	4.62	1.60	2.22	10
TAPC3/0-4/0-5	CTAP 4/0-4/0	HTAP 3/0-1, HTAP 3/0-3/0, HTAP 4/0-2, HTAP 4/0-3/0, HTAP 4/0-4/0	5.65	1.72	2.38	5
TAPC500-2	—	HTAP 500-4/0, HTAP 500-500	6.81	2.86	2.38	2

For information on copper CTAPs, see page D3.7.
For information on aluminum HTAPs, see page D2.122.

Joint Compounds

For Use with Aluminum Connectors

Type CMP

- Oxide inhibitor for compression conductor connections lowers electrical resistance of compression joint while sealing out air and moisture to prevent the formation of surface oxides
- Wide operating temperature range; can be used in a wide range of electrical and environmental conditions
- Packaged in convenient dispenser bottles



Part Number	Part Description	Std. Pkg. Qty.
CMP-100-1	Contact aid for pad-to-pad or thread-to-thread aluminum connections, 8 oz. Operating temperature range -60°F (-51°C) to 400°F (204°C).	1
CMP-200-1	Contact aid for cable connections with compression connections made on aluminum conductor, 8 oz. Operating temperature range -40°F (-40°C) to 400°F (204°C). Compatible with all insulating materials.	1

A. System Overview

B1. Cable Ties

B2. Cable Accessories

B3. Stainless Steel Ties

C1. Wiring Duct

C2. Surface Raceway

C3. Abrasion Protection

C4. Cable Management

D1. Terminals

D2. Power Connectors

D3. Grounding Connectors

E1. Labeling Systems

E2. Labels

E3. Pre-Printed & Write-On Markers

E4. Permanent Identification

E5. Lockout/Tagout & Safety Solutions

F. Index

A.
System
Overview

B1.
Cable Ties

B2.
Cable
Accessories

B3.
Stainless
Steel Ties

C1.
Wiring
Duct

C2.
Surface
Raceway

C3.
Abrasion
Protection

C4.
Cable
Management

D1.
Terminals

D2.
Power
Connectors

D3.
Grounding
Connectors

E1.
Labeling
Systems

E2.
Labels

E3.
Pre-Printed
& Write-On
Markers

E4.
Permanent
Identification

E5.
Lockout/
Tagout/
& Safety
Solutions

F.
Index

NOTES

PAN-LUG™ MECHANICAL CONNECTORS

PANDUIT offers a broad variety of mechanical lugs, splices, and split bolt connectors suitable for a wide range of electrical terminations using code conductor. Designed to be reusable and installed without special tooling, PAN-LUG™ Mechanical Connectors provide quality performance, ease of installation, and lowest installed cost.



- Functional product information is marked directly on the connector, facilitating the identification, ordering, and usage of the mechanical connector
- Incorporate wide wire range-taking capability to minimize inventory requirements
- Made from high strength, high conductivity electrolytic copper and aluminum alloy materials to provide optimum connectivity for power and grounding applications
- UL Listed and CSA Certified, as noted

PAN-LUG™ Mechanical Connectors include split bolt connectors, copper mechanical lugs, aluminum mechanical lugs and aluminum multi-tap connectors with clear PVC insulation. Products are available in stamped and formed, extruded and cast varieties of multiple barrel and tongue configurations to provide solutions for diverse power and grounding needs. PANDUIT offers a wide assortment of PAN-LUG™ Power and Grounding Connectors to meet customer needs and today's application requirements.

A.
System
Overview

B1.
Cable
Ties

B2.
Cable
Accessories

B3.
Stainless
Steel
Ties

C1.
Wiring
Duct

C2.
Surface
Raceway

C3.
Abrasion
Protection

C4.
Cable
Management

D1.
Terminals

D2.
Power
Connectors

D3.
Grounding
Connectors

E1.
Labeling
Systems

E2.
Labels

E3.
Pre-Printed
& Write-On
Markers

E4.
Permanent
Identification

E5.
Lockout/
Tagout/
& Safety
Solutions

F.
Index

A. System Overview

Features and Benefits – PAN-LUG™ Mechanical Connectors

B1. Cable Ties

Copper Split Bolt Connectors



Part number and conductor range marked on part for easy identification

Hex head with large wrench flats for easy assembly

Waxed body to prohibit binding of contact pad or nut

250 kcmil and larger sizes have contact serrations for higher pull-out strength

Extra-long body available to connect two taps with one run

Made from high strength copper alloy

UL LISTED **SF CERTIFIED**

Cast Copper Connectors

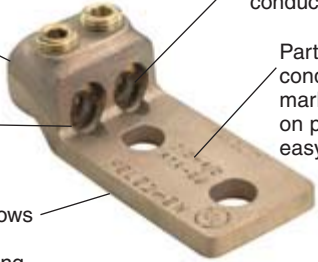

Made from high strength copper alloy

Inspection windows to assure complete conductor insertion

Serrated barrel available for high pull-out strength

Part number and conductor range marked on part for easy identification

Flat bottom allows full contact surface mounting

UL LISTED

B2. Cable Accessories

B3. Stainless Steel Ties

C1. Wiring Duct

C2. Surface Raceway

Stamped and Formed Copper Connectors

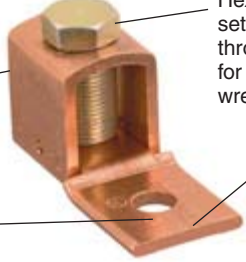

Made from high strength, electrolytic copper alloy

Hex head bolt (slotted set screw used up through 1/0 AWG sizes) for assembly with a wrench or screwdriver

Part number and conductor range marked on part for easy identification

Two styles of tongues available: fixed and floating

UL LISTED **SF CERTIFIED**

Aluminum Connectors

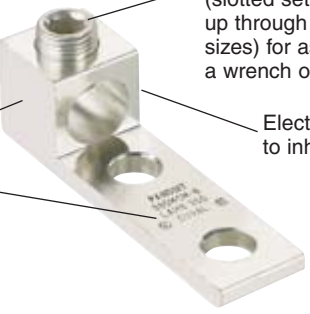

Dual rated for aluminum or copper conductors

Hex socket set screw (slotted set screw used up through 2/0 AWG sizes) for assembly with a wrench or screwdriver

Made from high strength, extruded aluminum alloy

Part number and conductor range marked on part for easy identification

Electro tin-plated to inhibit corrosion

UL LISTED **SF CERTIFIED**

C3. Abrasion Protection

C4. Cable Management

D1. Terminals

D2. Power Connectors

Multi-Tap Connectors



Hex socket set screws (slotted set screw for smallest size) for assembly with a wrench or screwdriver

Pre-insulated aluminum body to eliminate the need for taping

Clear PVC insulation for visual inspection of the complete conductor insertion

Dual-sided conductor entry

Factory pre-filled with oxide inhibitor to prevent oxidation

Made from high strength, extruded aluminum alloy

UL LISTED **SF CERTIFIED**

Available with two isolated mounting holes at either end of connector to facilitate direct mounting using 1/4" bolts.

D3. Grounding Connectors

E1. Labeling Systems

E2. Labels

E3. Pre-Printed & Write-On Markers

E4. Permanent Identification

E5. Lockout/Tagout & Safety Solutions



PANDUIT designs and manufactures a full line of labeling products, software, and printers to assist you with your labeling requirements. See pages E1.1 – E2.30.















PAN-STEEL® Stainless Cable Ties provide a strong, durable method of bundling and fastening, in all indoor, outdoor, and underground applications. See pages B3.2 – B3.19.



PANDUIT provides a complete selection of nylon cable ties to bundle, mount, and identify in countless indoor, outdoor, and harsh environment applications. See pages B1.1 – B1.84.

F. Index

Selection Guide – PAN-LUG™ Mechanical Connectors, Cast Copper

1. Select Connector Type and Stud Hole Size Desired			2. Determine Conductor Size and then Select PANDUIT Part Number																												
UL LISTED ‡	Mechanical Connector Type	Stud Hole Size In.	Copper Code Conductor Size																												
			#14 AWG	#12 AWG	#10 AWG	#8 AWG	#6 AWG	#4 AWG	#2 AWG	#1 AWG	1/0 AWG	2/0 AWG	3/0 AWG	4/0 AWG	250 kcmil	300 kcmil	350 kcmil	500 kcmil	600 kcmil	750 kcmil	800 kcmil	1000 kcmil									
			PANDUIT Part Number																												
	One-Hole, Straight Tongue HL	1/4	HL1-25-X ■*			HL4-1-X ■*			HL8-1-X*			HL13-1-5			HL21-1-5			HL30-1-2			HL50-1-2										
		3/8																													
		1/2																													
	One-Hole, Straight Tongue HLB	1/4	HLB4-1-X ■*																												
	One-Hole, Straight Tongue HLA-90	1/4	HLA4-1-90-X ■*			HLA8-1-90-X*			HLA13-1-90-5			HLA21-1-90-5																			
		3/8																													
	Two-Hole, Straight Tongue HL-2	1/4	HL1-2-25-X ■*			HL4-2-X ■*			HL8-2-X*			HL13-2-5			HL21-2-5			HL30-2-2			HL50-2-2										
		5/16																													
		3/8																													
	Two-Hole, Straight Tongue HL-2N	1/2				HL8-2N-X ◆*			HL13-2N-5 ◆			HL21-2N-5 ◆			HL30-2N-2 ◆																
	Two-Hole, Straight Tongue H2L-2N	1/2	H2L4-2N-X ◆ ■*			H2L8-2N-2 ◆*			H2L13-2N-2 ◆			H2L21-2N-2 ◆			H2L30-2N-1 ◆																
	Two-Way Connector HC	—	HC4-3 ■*			HC8-3*			HC13-3			HC21-1			HC30-1			HC50-1													
	Two-Hole, Straight Tongue HHL-2N	1/2				HHL8-2N-X ◆*			HHL13-2N-5 ◆			HHL21-2N-5 ◆			HHL30-2N-1 ◆																
	One-Hole, Straight Tongue PNL	#10	PNL-8-C ■*																												
		1/4	PNL-4-C ■*																												
		5/16	PNL-1/0-L*																												
		3/8	PNL-250-Q*																												
		1/2	PNL-500-3*																												
	One-Hole, Straight Tongue ML	3/16	ML8-CY ■*																												
		1/4	ML4-CY ■*																												
		5/16	ML1/0-LY*																												
		3/8	ML250-QY																												
	Two-Hole, Straight Tongue PNL-2	5/16	PNL-1/0-2-L*																												
		3/8	PNL-250-2-Q*																												
		1/2	PNL-500-2-3*																												
	Two-Way Connector PNLC	—	PNLC-1/0-3*																												
			PNLC-250-1*																												
			PNLC-500-1*																												

‡Type PNL is also CSA Certified, Type PNLC is not UL Listed or CSA Certified.

◆NEMA hole sizes and spacing.

■Uses slotted set screw.

*Denotes minimum conductor size is solid conductor.

A. System Overview

B1. Cable Ties

B2. Cable Accessories

B3. Stainless Steel Ties

C1. Wiring Duct

C2. Surface Raceway

C3. Abrasion Protection

C4. Cable Management

D1. Terminals

D2. Power Connectors

D3. Grounding Connectors

E1. Labeling Systems

E2. Labels

E3. Pre-Printed & Write-On Markers

E4. Permanent Identification

E5. Lockout/Tagout & Safety Solutions

F. Index

A. System Overview

B1. Cable Ties

B2. Cable Accessories

B3. Stainless Steel Ties

C1. Wiring Duct

C2. Surface Raceway

C3. Abrasion Protection

C4. Cable Management

D1. Terminals

D2. Power Connectors

D3. Grounding Connectors

E1. Labeling Systems

E2. Labels







E3. Pre-Printed & Write-On Markers

E4. Permanent Identification

E5. Lockout/Tagout & Safety Solutions

















F. Index

Selection Guide – PAN-LUG™ Mechanical Connectors, Stamped and Formed

		1. Select Connector Type and Stud Hole Size Desired				2. Determine Conductor Size and then Select PANDUIT Part Number																
UL LISTED	SEI CERTIFIED	Mechanical Connector Type	Current Rating AMPS	Stud Hole Size (In.)	Copper Code Conductor Size																	
					#14 AWG	#12 AWG	#10 AWG	#8 AWG	#6 AWG	#4 AWG	#2 AWG	#1 AWG	1/0 AWG	2/0 AWG	3/0 AWG	4/0 AWG	250 kcmil	350 kcmil	400 kcmil	500 kcmil	600 kcmil	750 kcmil
PANDUIT Part Number																						
	D2.145	One-Hole, Offset Tongue CB	25	1/8	CB25-18-CY■																	
			50	3/16	CB35-36-CY●■																	
			70	1/4	CBA70-14-CY■																	
			90		CB70-14-CY●■																	
			125	3/8						CB125-14-QY■												
			175		CB175-38-QY																	
			225		5/16	CB225-56-QY																
			300	3/8											CB300-38-QY							
			400													CB400-38-3Y						
650	1/2																		CB650-12-3Y			
	D2.145	Two Barrel, One-Hole, Offset Tongue DC	450	3/8									DC450-38-3Y									
			600																			
			800	1/2																		
	D2.146	Two-Hole, Offset Tongue CO	50	3/16	CO35-36-QY●■(1)																	
			90	1/4	CO70-14-QY●■(1)																	
			125		CO125-14-QY■(1)																	
			225	5/16	CO225-56-QY(1)																	
			300	3/8											CO300-38-3Y(3)							
			400													CO400-38-3Y(2)						
650	1/2																		CO650-12-3Y■(2)			
	D2.142	One-Hole, Straight "Fixed" Tongue CX	35	3/16	CX35-36-CY■																	
			70	1/4	CX70-14-CY●■																	
			125																			
			225	5/16											CX225-56-QY							
	D2.143	One-Hole, Straight Tongue CS	25	1/8	CS25-18-CY■																	
			50	3/16	CS35-36-CY●■																	
			70	1/4	CSA70-14-CY■																	
			90		CS70-14-CY●■																	
			125	3/8											CS125-14-QY■							
			175		CS175-38-QY																	
			225		5/16	CS225-56-QY																
			300	3/8												CS300-38-QY						
			400														CS400-38-3Y					
650	1/2																		CS650-12-3Y			
	D2.144	Two-Hole, Straight Tongue CD	50	3/16	CD35-36-QY●■(1)																	
			90	1/4	CD70-14-QY■(1)																	
			125		CD125-14-QY■(1)																	
			225	5/16	CD225-56-QY(1)																	
			300	3/8												CD300-38-3Y(1)						
			400														CD400-38-3Y(2)					
650	1/2																		CD650-12-3Y◆(2)			

- Multiple conductor combinations.
- ◆NEMA hole sizes and spacing.
- Uses slotted set screw.
- (1) 1.00" stud hole spacing.
- (2) 1.75" stud hole spacing.
- (3) 1.87" stud hole spacing.

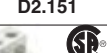
Selection Guide – PAN-LUG™ Mechanical Connectors, Aluminum

1. Select Connector Type and Stud Hole Size Desired		2. Determine Conductor Size and then Select PANDUIT Part Number																											
Mechanical Connector Type	Stud Hole Size (In.)	Aluminum/Copper Code Conductor Size																											
		#14 AWG	#12 AWG	#10 AWG	#8 AWG	#6 AWG	#4 AWG	#2 AWG	#1 AWG	1/0 AWG	2/0 AWG	3/0 AWG	4/0 AWG	250 kcmil	300 kcmil	350 kcmil	500 kcmil	600 kcmil	750 kcmil	800 kcmil	1000 kcmil								
		PANDUIT Part Number																											
  D2.147 One Barrel, One-Hole LAMA	1/4	LAMA6-14-QY■				LAMA14-14-QY■				LAMA10-14-QY■				LAMA20-14-QY■															
	5/16					LAMA250-56-QY				LAMA300-56-QY				LAMA350-38-QY															
	3/8					LAMA500-38-6Y				LAMA600-38-6Y				LAMA600S-38-6Y‡															
	5/8													LAMA800-58-6Y				LAMA1000-58-6Y											
  D2.148 One Barrel, Two-Hole LAMB	1/2					LAMB350-12-6Y◆				LAMB600-12-3Y◆								LAML800-12-3Y◆▲											
  D2.148 Two Barrel, One-Hole LAM2A	1/4	LAM2A10-14-6Y■				LAM2A20-14-6Y■ ^																							
	3/8					LAM2A250-38-6Y				LAM2A350-12-6Y				LAM2A600-12-6Y															
	1/2																	LAM2A800-58-6Y				LAM2A1000-58-6Y‡‡^							
	5/8																												
  D2.149 Two Barrel, Two-Hole LAM2B	1/2					LAM2B350-12-3Y◆				LAM2B600-12-3Y◆				LAM2LB800-12-3Y▲‡‡															
  D2.150 Two Barrel, Two-Hole LAM2SB	3/8					LAM2SB600-38-1Y				LAM2SB750-38-1Y^				LAM2SB500-141Y▲															
	1/4																												
 D2.150 Three Barrel, Two-Hole LAM3B	5/16	LAM3B2-14-6Y■																											
	3/8	LAM3B10-38-6Y■				LAM3B30-12-3Y◆				LAM3B250-12-1Y◆				LAM3B350-12-1Y◆				LAM3B600-12-1Y◆				LAM3LB800-12-1Y◆▲				LAM3LB1000-121Y◆▲			
	1/2																												
  D2.151 Three Barrel, Two-Hole LAM3SB	3/8					LAM3SB600-38-1Y				LAM3SB750-38-1Y				LAM2SB500-141Y▲															
 D2.151 Three Barrel, Four-Hole LAM3D	1/2					LAM3D30-12-3Y◆■				LAM3D250-12-1Y◆				LAM3D350-12-1Y◆				LAM3D600-12-1Y				LAM3LD800-12-1Y◆▲				LAM3LD1000-121Y◆▲			
  D2.152 Four Barrel, Two-Hole LAM4SB	3/8					LAM4SB600-38-1Y				LAM4SB750-38-1Y																			
 D2.152 Four Barrel, Four-Hole LAM4D	1/2					LAM4D250-12-1Y◆				LAM4D350-12-1Y◆				LAM4D600-12-1Y◆				LAM4LD800-12-1Y◆▲											

‡LAMA600S-38-6 can also be used with (2) 250 kcmil-1/0 AWG conductors.

◆NEMA hole sizes and spacing.

■Uses slotted set screws.

▲Uses double set screws.

^Not CSA Certified.

‡‡Not UL Listed.

Note: Use of PANDUIT oxide inhibiting joint compound CMP-100 is recommended for use with aluminum mechanical connectors.

A. System Overview

B1. Cable Ties

B2. Cable Accessories

B3. Stainless Steel Ties

C1. Wiring Duct

C2. Surface Raceway

C3. Abrasion Protection

C4. Cable Management

D1. Terminals

D2. Power Connectors

D3. Grounding Connectors

E1. Labeling Systems

E2. Labels

E3. Pre-Printed & Write-On Markers

E4. Permanent Identification

E5. Lockout/Tagout & Safety Solutions

F. Index

A. System Overview

Selection Guide – PAN-LUG™ Mechanical Connectors, Split Bolts and Multi-Taps

B1. Cable Ties

1. Select Split Bolt Style Desired
2. Determine Conductor Range and then Select **PANDUIT** Part Number

B2. Cable Accessories

Copper Split Bolt Connectors – SBC

For Use with Copper Code Conductors



PANDUIT Part Number	Conductor Size Range**		PANDUIT Part Number	Copper Conductor Range**	
	Min.	Max.		Min.	Max.
SBC8-C	#10 STR	#8 STR	SBC1/0-L	#4 STR	1/0 STR
SBC8L-C^	#16 STR	#8 STR	SBC2/0-Q	#2 STR	2/0 STR
SBC6S-C	#8 STR	#6 SOL	SBC3/0-Q	#1 STR	3/0 STR
SBC6SL-C^	#8 STR	#6 STR	SBC250-Q	#1 STR	250 kcmil
SBC4S-C	#8 STR	#6 STR	SBC350-1	2/0 STR	350 kcmil
SBC4SL-C^	#8 STR	#6 STR	SBC500-1	300 kcmil	500 kcmil
SBC3-C	#8 STR	#4 STR	SBC750-1	#8 SOL	750 kcmil
SBC2-C	#6 STR	#2 STR	SBC1000-1	#8 SOL	1000 kcmil
SBC2L-C^	#14 STR	#2 STR			

^Long body accommodates two tap conductors with single run; not CSA Certified.
 **The conductor sizes shown are for equal run and tap combinations

C1. Wiring Duct

C2. Surface Raceway

Tin Plated Copper Split Bolt Connectors – SBCT

For Use with Combinations of Copper and Aluminum Conductors



PANDUIT Part Number	Copper and Aluminum Conductor Range		
	Range of Equal Run and Tap		Min. Tap with One Max. Run
	Min.	Max.	
SBCT8-C	#8 STR	#6 SOL	#14 STR
SBCT6-C	#8 STR	#6 STR	#10 STR
SBCT3-C	#8 STR	#4 STR	#10 STR
SBCT2-C	#6 STR	#2 STR	#14 STR
SBCT1/0-L	#4 STR	1/0 STR	#10 STR
SBCT2/0-Q	#2 STR	2/0 STR	#8 STR
Copper Conductor Range			
SBCT10-C	#16 STR	#10 STR	#16 STR
SBCT3/0-Q	#1 STR	3/0 STR	#8 STR
SBCT250-Q	#1 STR	250 kcmil	#8 STR
SBCT350-1	2/0 STR	350 kcmil	1/0 STR
SBCT500-1	300 kcmil	500 kcmil	2/0 STR
SBCT750-1	2/0 STR	750 kcmil	2/0 STR
SBCT1000-1	4/0 STR	1000 kcmil	4/0 STR

D1. Terminals

D2. Power Connectors

Dual Rated Aluminum Split Bolt Connectors – SBA

For Use with Aluminum and Copper Conductor Combinations



PANDUIT Part Number	Aluminum to Aluminum, Aluminum to Copper, Copper to Copper Conductors					
	Max. Run to Max. Tap		Min. Run to Min. Tap		Max. Run to Min. Tap	
SBA6-C	#6 STR	#6 STR	#10 SOL	#10 SOL	#6 STR	#10 SOL
SBA4-C	#4 STR	#4 STR	#8 SOL	#10 SOL	#4 STR	#2 SOL
SBA2-C	#2 STR	#2 STR	#6 SOL	#8 STR	#2 STR	#8 STR
SBA1/0-Q	1/0 STR	1/0 STR	#2 STR (Compact)	#8 SOL	1/0 STR	#8 SOL
SBA2/0-Q	2/0 STR	2/0 STR	#2 STR (Compact)	#8 STR	2/0 STR	#8 STR
SBA4/0-Q	4/0 STR	4/0 STR	#2 STR (Compact)	#6 STR	4/0 STR	#6 STR
SBA350-1^	350 kcmil	350 kcmil	1/0 STR (Compact)	#4 STR	350 kcmil	#4 STR
SBA500-1^	500 kcmil	500 kcmil	400 kcmil (Compact)	#2 STR (Compact)	500 kcmil	#2 STR (Compact)

^Not CSA Certified.

E3. Pre-Printed & Write-On Markers

Multi-Tap Connectors with Clear Insulation

For Use with Aluminum and Copper Code Conductor Combinations



D2.155 – D2.160



Type	Description	No. of Ports	Copper or Aluminum Code Conductor Range
PCSB	Double-Sided Wire Entry	2 to 14	14 AWG Solid to 750 kcmil
PCSB-S	Single-Sided Wire Entry	2 to 14	14 AWG Stranded to 600 kcmil
PISR	In-Line Splicer/Reducer	2	14 AWG Stranded to 500 kcmil
PCSBM	Double-Sided Wire Entry Mountable	2 to 14	14 AWG Stranded to 600 kcmil
PCSBMT	Single-Sided Wire Entry Mountable	2 to 14	14 AWG Stranded to 600 kcmil

E4. Permanent Identification

E5. Lockout/Tagout & Safety Solutions

F. Index



Split Bolt, Copper

For Use with Copper Code Conductors

Type SBC

- Made from high strength copper alloy to resist corrosion and provide premium electrical and mechanical performance
- Offered with extra long body to allow connection of one or two taps to a single run conductor
- Wide wire range-taking capability minimizes inventory requirements
- Nut hex provides correct fit with socket, box, or open end wrenches resulting in proper torquing of electrical connection

- Pressure bar provides secure connection on a full range of conductor combinations used with each connector assuring premium wire pull-out strength
- UL Listed and CSA Certified for use up to 600 V and temperature rated 90°C

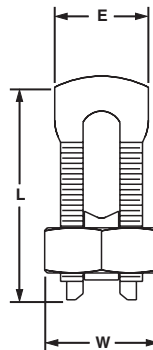

Part Number	Copper Conductor			Max. Conductor Copperweld STR	Figure Dimensions (In.)			Tightening Torque (In.-Lbs.)	Std. Pkg. Qty.
	Range of Equal Run and Tap		Min. Tap with One Max. Run		E	W	L		
	Min.	Max.							
SBC8-C	#10 STR	#8 STR	#16 STR	—	.39	.55	.86	80	100
SBC8L-C*	#16 STR	#8 STR	#16 STR	—	.38	.50	.84	80	100
SBC6S-C	#8 STR	#6 SOL	#16 STR	—	.41	.62	.95	165	100
SBC6SL-C*	#8 STR	#6 STR	#16 STR	—	.41	.63	1.10	165	100
SBC4S-C	#8 STR	#6 STR	#14 STR	—	.45	.69	.98	165	100
SBC4SL-C*	#8 STR	#6 STR	#14 STR	—	.45	.69	1.30	165	100
SBC3-C	#8 STR	#4 STR	#14 STR	—	.58	.81	1.16	275	100
SBC2-C	#6 STR	#2 STR	#14 STR	—	.59	.86	1.23	275	100
SBC2L-C*	#14 STR	#2 STR	#14 STR	3 No. 7	.63	.81	1.55	275	100
SBC1/0-L	#4 STR	1/0 STR	#14 STR	—	.75	.93	1.55	385	50
SBC2/0-Q	#2 STR	2/0 STR	#14 STR	—	.79	1.05	1.72	385	25
SBC3/0-Q	#1 STR	3/0 STR	#8 STR	—	.95	1.24	2.07	500	25
SBC250-Q	#1 STR	250 kcmil	#8 STR	—	1.03	1.36	2.09	650	25
SBC350-1	2/0 STR	350 kcmil	1/0 STR	—	1.16	1.48	2.42	650	1
SBC500-1	300 kcmil	500 kcmil	2/0 STR	—	1.33	1.74	2.83	825	1
SBC750-1	#8 SOL	750 kcmil	#8 SOL	19 No. 5	1.94	2.13	3.75	1000	1
SBC1000-1	#8 SOL	1000 kcmil	#8 SOL	—	2.25	2.50	4.00	1100	1

*Long body accommodates two tap conductors with single run; not CSA Certified.

A.
System
Overview

B1.
Cable
Ties

B2.
Cable
Accessories

B3.
Stainless
Steel
Ties

C1.
Wiring
Duct

C2.
Surface
Raceway

C3.
Abrasion
Protection

C4.
Cable
Management

D1.
Terminals

D2.
Power
Connectors

D3.
Grounding
Connectors

E1.
Labeling
Systems

E2.
Labels

E3.
Pre-Printed
& Write-On
Markers

E4.
Permanent
Identification

E5.
Lockout/
Tagout/
& Safety
Solutions

F.
Index

A. System Overview

B1. Cable Ties

B2. Cable Accessories

B3. Stainless Steel Ties

C1. Wiring Duct

C2. Surface Raceway

C3. Abrasion Protection

C4. Cable Management

D1. Terminals

D2. Power Connectors

D3. Grounding Connectors

E1. Labeling Systems

E2. Labels

E3. Pre-Printed & Write-On Markers

E4. Permanent Identification

E5. Lockout/Tagout & Safety Solutions

F. Index



Split Bolt, Copper, Tin-Plated

For Specified Combinations of Copper and Aluminum Code Conductors

Type SBCT

- Made from high strength copper alloy to provide premium electrical and mechanical performance
- Tin-plated to inhibit corrosion and oxidation
- Offered with dual rating for use with aluminum or copper conductors
- Wide wire range-taking capability minimizes inventory requirements
- Nut hex provides correct fit with socket, box, or open end wrenches resulting in proper torquing of electrical connection
- Free floating pressure bar separates conductors of dissimilar materials for secure connection on a full range of conductor combinations
- UL Listed and CSA Certified for use up to 600 V and UL temperature rated 90°C

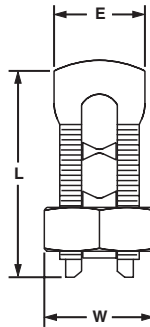

Part Number	Copper and Aluminum Code Conductor			ACSR Range	Max. Conductor		Figure Dimensions (In.)			Tightening Torque (In.-Lbs.)	Std. Pkg. Qty.
	Range of Equal Run and Tap		Min. Tap with One Max. Run		Copperweld	STR	E	W	L		
	Min.	Max.									

UL Listed and CSA Certified with Copper and Aluminum Conductors

SBCT8-C	#8 STR	#6 SOL	#14 STR	—	—	.49	.62	1.10	165	100
SBCT6-C	#8 STR	#6 STR	#10 STR	—	—	.56	.68	1.28	165	100
SBCT3-C	#8 STR	#4 STR	#10 STR	—	—	.69	.80	1.55	275	100
SBCT2-C	#6 STR	#2 STR	#14 STR	—	—	.69	.80	1.54	275	100
SBCT1/0-L	#4 STR	1/0 STR	#10 STR	—	—	.75	.86	1.63	385	50
SBCT2/0-Q	#2 STR	2/0 STR	#8 STR	—	—	.82	.99	1.82	385	25

UL Listed and CSA Certified with Copper Code Conductors Only

SBCT10-C	#16 STR	#10 STR	#16 STR	—	—	.38	.49	.87	80	100
SBCT3/0-Q	#1 STR	3/0 STR	#8 STR	—	—	.88	1.12	2.01	500	25
SBCT250-Q	#1 STR	250 kcmil	#8 STR	—	—	1.00	1.27	1.37	650	25
SBCT350-1	2/0 STR	350 kcmil	1/0 STR	—	—	1.50	1.63	2.57	650	1
SBCT500-1	300 kcmil	500 kcmil	2/0 STR	—	—	1.65	1.81	3.00	825	1
SBCT750-1	2/0 STR	750 kcmil	2/0 STR	4/0 – 666.6	19 No. 5	1.93	2.11	3.78	1000	1
SBCT1000-1	4/0 STR	1000 kcmil	4/0 STR	300 – 900	—	2.29	2.53	4.02	1100	1

The use of PANDUIT oxide inhibiting joint compound (CMP-100) is recommended. See pages D2.123 and D2.161.

UL LISTED SP® Split Bolt, Aluminum

For Use with Copper and Aluminum Code Conductors

Type SBA

- Made from lightweight, durable aluminum alloy to resist corrosion and provide premium electrical and mechanical performance
- Dual rated for use with aluminum to aluminum, aluminum to copper, and copper to copper conductor combinations
- Tin-plated to inhibit corrosion and oxidation
- Wide wire range-taking capability minimizes inventory requirements
- True hex design for body and nut hex provides correct fit with socket, box, or open end wrenches resulting in proper torquing of electrical connection
- Free floating pressure bar separates conductors of dissimilar materials for secure connection on a full range of conductor combinations
- UL Listed and CSA Certified for use up to 600 V and UL temperature rated 90°C

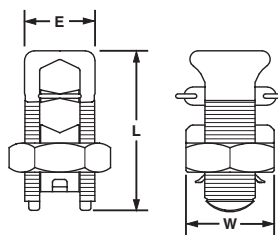

Part Number	Max. Run to Max. Tap	Min. Run to Min. Tap	Max. Run to Min. Tap	Figure Dimensions (In.)			Tightening Torque (In.-Lbs.)	Std. Pkg. Qty.
				E	W	L		
SBA6-C	#6 STR – #6 STR	#10 SOL – #10 SOL	#6 STR – #10 SOL	.56	.75	1.58	165	100
SBA4-C	#4 STR – #4 STR	#8 SOL – #10 SOL	#4 STR – #10 SOL	.62	.81	1.38	165	100
SBA2-C	#2 STR – #2 STR	#6 SOL – #8 STR	#2 STR – #8 STR	.69	.94	1.58	275	100
SBA1/0-Q	1/0 STR – 1/0 STR	#2 STR (Compact) – #8 SOL	1/0 STR – #8 SOL	.75	1.00	1.92	385	25
SBA2/0-Q	2/0 STR – 2/0 STR	#2 STR (Compact) – #8 STR	2/0 STR – #8 STR	.88	1.12	1.92	385	25
SBA4/0-Q	4/0 STR – 4/0 STR	#2 STR (Compact) – #6 STR	4/0 STR – #6 STR	1.13	1.49	2.54	500	25
[^] SBA350-1	350 kcmil – 350 kcmil	1/0 STR (Compact) – #4 STR	350 kcmil – #4 STR	1.50	1.69	3.24	650	1
[^] SBA500-1	500 kcmil – 500 kcmil	400 kcmil (Compact) – #2 STR (Compact)	500 kcmil – #2 STR (Compact)	1.73	2.00	3.62	825	1

The use of PANDUIT oxide inhibiting joint compound (CMP-100) is recommended. See page D2.161.
[^]Not CSA Certified.

UL LISTED Two-Bolt Connector, Bronze

For Use with Copper Code Conductors

Type VT

- Made from high strength bronze for heavy duty connections and to inhibit corrosion
- Cap swivels for easy installation of conductors
- Rubber washer retains hardware to connector and eliminates loose parts
- High strength silicon-bronze hardware provides premium mechanical performance when assembled to conductor
- Wide wire range-taking capability minimizes inventory requirements
- UL Listed for use up to 600 V and 90°C temperature rated

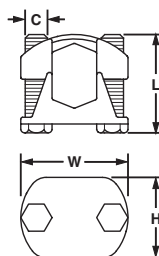

Part Number	Copper Conductor Size		Figure Dimensions (In.)				Hex Size	Tightening Torque (In.-Lbs.)	Std. Pkg. Qty.
	Run	Tap	L	W	H	C			
VT-0-Q	#2 STR – 1/0 STR	#10 STR – 1/0 STR	1.50	1.44	.94	.31	1/2	180	25
VT-1-Q	#2 STR – 2/0 STR	#10 STR – 2/0 STR	1.50	1.56	1.13	.31	1/2	180	25
VT-2-Q	1/0 STR – 4/0 STR	#10 STR – 4/0 STR	1.75	1.84	1.34	.38	9/16	240	25
VT-3-12	250 kcmil – 350 kcmil	#10 STR – 350 kcmil	2.00	2.31	1.63	.50	3/4	480	12
VT-4-12	250 kcmil – 500 kcmil	#10 STR – 500 kcmil	2.25	2.44	1.69	.50	3/4	480	12
VT-5-6	400 kcmil – 800 kcmil	3/0 STR – 800 kcmil	2.50	2.69	1.88	.50	9/16	480	6
VT-6-6	500 kcmil – 1000 kcmil	3/0 STR – 1000 kcmil	2.75	3.06	2.25	.63	15/16	660	6

- A. System Overview
- B1. Cable Ties
- B2. Cable Accessories
- B3. Stainless Steel Ties
- C1. Wiring Duct
- C2. Surface Raceway
- C3. Abrasion Protection
- C4. Cable Management
- D1. Terminals
- D2. Power Connectors
- D3. Grounding Connectors
- E1. Labeling Systems
- E2. Labels
- E3. Pre-Printed & Write-On Markers
- E4. Permanent Identification
- E5. Lockout/Tagout & Safety Solutions
- F. Index

A. System Overview

B1. Cable Ties

B2. Cable Accessories

B3. Stainless Steel Ties

C1. Wiring Duct

C2. Surface Raceway

C3. Abrasion Protection

C4. Cable Management

D1. Terminals

D2. Power Connectors

D3. Grounding Connectors

E1. Labeling Systems

E2. Labels

E3. Pre-Printed & Write-On Markers

E4. Permanent Identification

E5. Lockout/Tagout & Safety Solutions

F. Index

Two-Bolt Connector, Bronze, Tin-Plated

For Use with Copper and Aluminum Code Conductors

Type VTA

- Made from high strength bronze for heavy duty connections
- Tin-plated to inhibit corrosion and oxidation
- Cap swivels for easy installation of conductors
- Rubber washer retains hardware to connector and eliminates loose parts
- High strength silicon-bronze hardware provides premium mechanical performance when assembled to conductor
- Offered for use with aluminum conductors, but not UL Listed
- UL Listed for use up to 600 V and 90°C temperature rated when used with copper code conductor

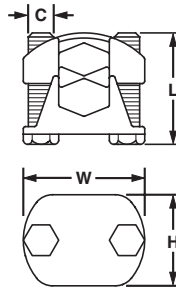

Part Number	Max. Copper Conductor Size	Max. Aluminum Conductor Size*	Copperweld Solid	Figure Dimensions (In.)				Hex Size (In.)	Tightening Torque (In.-Lbs.)	Std. Pkg. Qty.
				L	W	H	C			
VTA-0-Q	2/0 SOL – 1/0 STR	1/0 STR – 1 ACSR	2/0	1.25	1.44	.94	5/16	1/2	180	25
VTA-1-Q	3/0 SOL – 2/0 STR	—	3/0	1.50	1.56	1.13	5/16	1/2	180	25
VTA-2-Q	4/0 SOL – 4/0 STR	—	4/0	1.75	1.84	1.34	3/8	9/16	240	25
VTA-3-12	350 kcmil	—	—	2.00	2.31	1.63	1/2	3/4	480	12
VTA-4-12	500 kcmil	—	—	2.25	2.44	1.69	1/2	3/4	480	12
VTA-5-6	800 kcmil	—	—	2.50	2.69	1.88	1/2	3/4	480	6
VTA-6-6	1000 kcmil	—	—	2.75	3.06	2.25	5/8	15/16	660	6

*Not UL Listed.

One-Hole, Straight Tongue, Barrel Post Lug

For Use with Copper Code Conductors

Type ML

- Made from high strength electrolytic copper to provide premium electrical and mechanical performance
- Compact design saves space
- Wide wire range-taking capability minimizes inventory requirements
- Inspection window to visually assure full conductor insertion
- Plated steel set screw provides high strength, durable electrical contact between conductor and connector
- Flat bottom allows for complete contact with mounting surface
- UL Listed for use up to 600 V and temperature rated 90°C

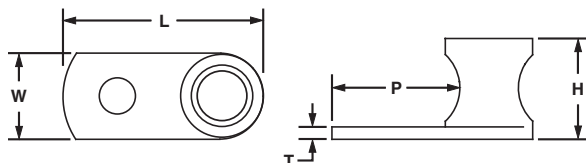

Part Number	Copper Conductor Size Range	Stud Hole Size (In.)	Hex Key Size (In.)	Figure Dimensions (In.)					Tightening Torque (In.-Lbs.)	Std. Pkg. Qty.
				L	W	H	T	P		
ML8-CY	#14 SOL – #8 STR	3/16	**	.81	.38	.38	.08	.48	25	100
ML4-CY	#14 SOL – #4 STR	1/4	**	1.13	.50	.53	.09	.63	45	100
ML1/0-LY	#8 SOL – 1/0 STR	5/16	1/4	1.50	.75	.75	.09	.80	200	50
ML250-QY	#6 STR – 250 kcmil	3/8	1/4	1.94	.94	1.06	.13	1.00	200	25

**Uses slotted head set screw.

One-Hole, Straight Tongue, Tin-Plated, Barrel Post Lug

For Use with Copper Code Conductors

Type ML-T

- Made from high strength, electrolytic copper to provide premium electrical and mechanical performance
- Tin-plated to inhibit corrosion
- Compact design saves space
- Wide wire range-taking capability minimizes inventory requirements
- Inspection window to visually assure full conductor insertion
- Plated steel set screw provides high strength, durable electrical contact between conductor and connector
- Flat bottom allows for complete contact with mounting surface
- UL Listed for use up to 600 V and temperature rated 90°C

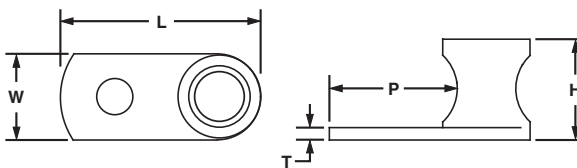

Part Number	Copper Conductor Size Range	Stud Hole Size (In.)	Hex Key Size (In.)	Figure Dimensions (In.)					Tightening Torque (In.-Lbs.)	Std. Pkg. Qty.
				L	W	H	T	P		
ML8T-CY	#14 SOL – #8 STR	3/16	**	.81	.38	.38	.08	.48	25	100
ML4T-CY	#14 SOL – #4 STR	1/4	**	1.13	.50	.53	.09	.63	45	100
ML1/0T-LY	#8 SOL – 1/0 STR	5/16	1/4	1.50	.75	.75	.09	.80	200	50
ML250T-QY	#6 STR – 250 kcmil	3/8	1/4	1.94	.94	1.06	.13	1.00	200	25

**Uses slotted head set screw.

One-Hole, Straight Tongue Lug

For Use with Copper Code Conductors

Type PNL

- Cast from high strength corrosion resistant copper alloy to provide premium electrical and mechanical performance
- Compact design saves space
- Wide wire range-taking capability minimizes inventory requirements
- Inspection window to visually assure full conductor insertion
- Plated steel set screw provides high strength, durable electrical contact between conductor and connector
- Flat bottom allows for complete contact with mounting surface
- UL Listed and CSA Certified for use up to 600 V and UL temperature rated 90°C

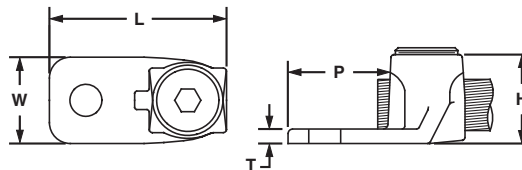

Part Number	Copper Conductor Size Range	Stud Hole Size (In.)	Hex Key Size (In.)	Figure Dimensions (In.)					Tightening Torque (In.-Lbs.)	Std. Pkg. Qty.
				L	W	H	T	P		
PNL-8-C	#14 SOL – #8 STR	#10	**	.88	.38	.44	.09	.50	25	100
PNL-4-C	#14 SOL – #4 STR	1/4	**	1.25	.53	.56	.14	.66	45	100
PNL-1/0-L	#8 SOL – 1/0 STR	5/16	1/4	1.59	.73	.78	.14	.85	200	50
PNL-250-Q	#6 SOL – 250 kcmil	3/8	5/16	1.97	.94	1.05	.13	1.00	275	25
PNL-500-3	#4 SOL – 500 kcmil	1/2	3/8	3.00	1.38	1.47	.25	1.63	375	3
PNL-1000-3	500 kcmil – 1000 kcmil	1/2	1/2	3.88	1.75	2.00	.38	2.13	500	3

**Uses slotted head set screw.

A.
System
Overview

B1.
Cable Ties

B2.
Cable
Accessories

B3.
Stainless
Steel Ties

C1.
Wiring
Duct

C2.
Surface
Raceway

C3.
Abrasion
Protection

C4.
Cable
Management

D1.
Terminals

D2.
Power
Connectors

D3.
Grounding
Connectors

E1.
Labeling
Systems

E2.
Labels

E3.
Pre-Printed
& Write-On
Markers

E4.
Permanent
Identification

E5.
Lockout/
Tagout
& Safety
Solutions

F.
Index

A. System Overview

B1. Cable Ties

B2. Cable Accessories

B3. Stainless Steel Ties

C1. Wiring Duct

C2. Surface Raceway

C3. Abrasion Protection

C4. Cable Management

D1. Terminals

D2. Power Connectors

D3. Grounding Connectors

E1. Labeling Systems

E2. Labels

E3. Pre-Printed & Write-On Markers

E4. Permanent Identification

E5. Lockout/Tagout & Safety Solutions

F. Index

One-Hole, Straight Tongue Lug with Internal Pressure Plate

For Use with Copper Code Conductors

Type HL

- Cast from high strength corrosion resistant copper alloy to provide premium electrical and mechanical performance
- Compact design saves space
- Wide wire range-taking capability minimizes inventory requirements
- Pressure plate* provides uniform clamping force on conductor for premium electrical performance
- Plated steel set screw provides high strength, durable electrical contact between conductor and connector
- Flat bottom allows for complete contact with mounting surface
- Inspection window to visually assure full conductor insertion
- UL Listed for use up to 600 V and temperature rated 90°C

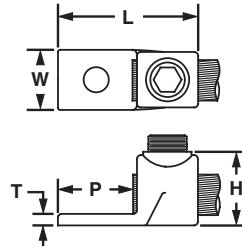

Part Number	Copper Conductor Size Range	Stud Hole Size (In.)	Hex Key Size (In.)	Figure Dimensions (In.)					Tightening Torque (In.-Lbs.)	Std. Pkg. Qty.
				L	W	H	T	P		
HL1-25-X	#14 SOL – #8 STR	1/4	**	1.25	.56	.79	.19	.63	20	10
HL4-1-X	#8 SOL – #4 STR	1/4	**	1.25	.56	.79	.19	.63	35	10
HL8-1-X	#4 SOL – #1 STR	1/4	7/16	1.56	.75	.90	.22	.69	100	10
HL13-1-5	#1 STR – 2/0 STR	3/8	9/16	1.88	.81	1.14	.22	.88	250	5
HL21-1-5	2/0 STR – 4/0 STR	3/8	9/16	2.19	1.00	1.31	.25	1.00	250	5
HL30-1-2	4/0 STR – 300 kcmil	1/2	5/8	2.50	1.06	1.47	.31	1.25	350	2
HL50-1-2	300 kcmil – 500 kcmil	1/2	3/4	3.00	1.38	1.65	.34	1.50	480	2

*HL1-25-X and HL4-1-X do not include pressure plates.
**Uses slotted head set screw.

One-Hole, Straight Tongue, Flag Lug

For Use with Copper Code Conductors

Type HLB

- Provides connection of conductor at right angles to terminal bar
- Cast from high strength corrosion resistant copper alloy to provide premium electrical and mechanical performance
- Compact design saves space
- Wire range-taking capability minimizes inventory requirements
- Internal pressure plate provides uniform clamping force on conductor for premium electrical performance
- Flush bottom allows for complete contact with mounting surface
- Inspection window to visually assure full conductor insertion
- UL Listed for use up to 600 V and temperature rated 90°C

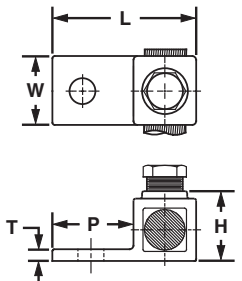

Part Number	Copper Conductor Size Range	Stud Hole Size (In.)	Hex Key Size (In.)	Figure Dimensions (In.)					Tightening Torque (In.-Lbs.)	Std. Pkg. Qty.
				L	W	H	T	P		
HLB4-1-X	#8 SOL – #4 STR	1/4	**	1.25	.50	.79	.19	.63	35	10

**Uses slotted head set screw.

One-Hole, Straight Tongue, 90° Lug

For Use with Copper Code Conductors

Type HLA-90

- Provides connection of conductor at right angles to terminal bar
- Cast from high strength corrosion resistant copper alloy to provide premium electrical and mechanical performance
- Compact design saves space
- Wide wire range-taking capability minimizes inventory requirements
- Internal pressure plate provides uniform clamping force on conductor for premium electrical performance
- Flush bottom allows for complete contact with mounting surface
- UL Listed for use up to 600 V and temperature rated 90°C

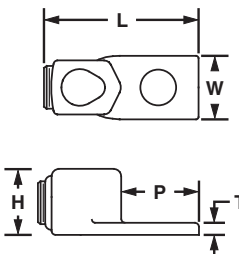

Part Number	Copper Conductor Size Range	Stud Hole Size (In.)	Hex Key Size (In.)	Figure Dimensions (In.)					Tightening Torque (In.-Lbs.)	Std. Pkg. Qty.
				L	W	H	T	P		
HLA4-1-90-X	#8 SOL – #4 STR	1/4	**	1.81	.56	.73	.19	.63	35	10
HLA8-1-90-X	#4 SOL – #1 STR	1/4	7/16	1.50	.75	.75	.22	.69	100	10
HLA13-1-90-5	#1 STR – 2/0 STR	3/8	9/16	2.38	.81	1.00	.22	.88	250	5
HLA21-1-90-5	2/0 STR – 4/0 STR	3/8	9/16	2.69	1.00	1.14	.25	1.00	250	5

**Uses slotted head set screw.

Two-Hole, Straight Tongue Lug

For Use with Copper Code Conductors

Type PNL-2

- Cast from high strength corrosion resistant copper alloy to provide premium electrical and mechanical performance
- Wide wire range-taking capability minimizes inventory requirements
- Inspection window to visually assure full conductor insertion
- Plated steel set screw provides high strength, durable electrical contact between conductor and connector
- Flat bottom allows for complete contact with mounting surface
- UL Listed for use up to 600 V and temperature rated 90°C
- Available with NEMA hole sizes and spacing

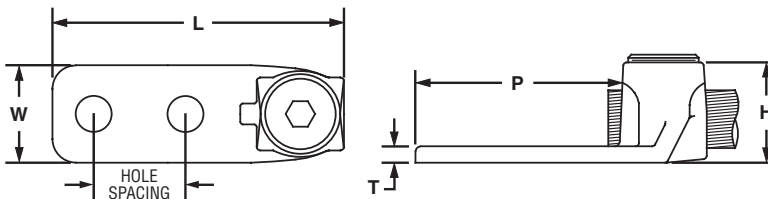

Part Number	Copper Conductor Size Range	Stud Hole Size (In.)	Stud Hole Spacing (In.)	Hex Key Size (In.)	Figure Dimensions (In.)					Tightening Torque (In.-Lbs.)	Std. Pkg. Qty.
					L	W	H	T	P		
PNL-1/0-2-L	#8 SOL – 1/0 STR	5/16	1.00	1/4	2.75	.75	.84	.19	2.00	200	50
PNL-250-2-Q	#6 SOL – 250 kcmil	3/8	1.00	1/4	2.88	.94	1.03	.22	2.02	200	25
PNL-500-2-3	#4 SOL – 500 kcmil	3/8	1.00	3/8	3.38	1.38	1.47	.31	2.00	375	3
PNL-1000-2-3	500 kcmil – 1000 kcmil	1/2	1.50	3/8	4.88	1.75	2.00	.38	3.13	375	3

A. System Overview

B1. Cable Ties

B2. Cable Accessories

B3. Stainless Steel Ties

C1. Wiring Duct

C2. Surface Raceway

C3. Abrasion Protection

C4. Cable Management

D1. Terminals

D2. Power Connectors

D3. Grounding Connectors

E1. Labeling Systems

E2. Labels

E3. Pre-Printed & Write-On Markers

E4. Permanent Identification

E5. Lockout/Tagout & Safety Solutions

F. Index

A.
System
Overview

B1.
Cable Ties

B2.
Cable
Accessories

B3.
Stainless
Steel Ties

C1.
Wiring
Duct

C2.
Surface
Raceway

C3.
Abrasion
Protection

C4.
Cable
Management

D1.
Terminals

D2.
Power
Connectors

D3.
Grounding
Connectors

E1.
Labeling
Systems

E2.
Labels

E3.
Pre-Printed
& Write-On
Markers

E4.
Permanent
Identification

E5.
Lockout/
Tagout/
& Safety
Solutions

F.
Index



Two-Hole, Straight Tongue Lug with Internal Pressure Plate

For Use with Copper Code Conductors

Type HL-2

- Cast from high strength corrosion resistant copper alloy to provide premium electrical and mechanical performance
- Wide wire range-taking capability minimizes inventory requirements
- Internal pressure plate provides uniform clamping force on conductor for premium electrical performance
- Plated steel set screw provides high strength, durable electrical contact between conductor and connector
- Inspection window to visually assure full conductor insertion
- Flat bottom allows for complete contact with mounting surface
- UL Listed for use up to 600 V and temperature rated 90°C

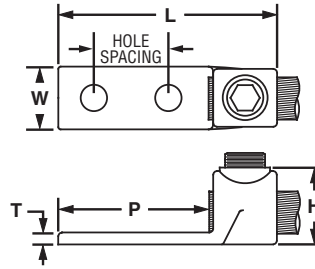

Part Number	Copper Conductor Size Range	Stud Hole Size (In.)	Stud Hole Spacing (In.)	Hex Key Size (In.)	Figure Dimensions (In.)					Tightening Torque (In.-Lbs.)	Std. Pkg. Qty.
					L	W	H	T	P		
HL1-2-25-X	#14 SOL – #8 STR	1/4	.63	**	2.00	.56	.70	.19	1.25	20	10
HL4-2-X	#8 SOL – #4 STR	1/4	.63	**	2.00	.56	.69	.18	1.25	35	10
HL8-2-X	#4 SOL – #1 STR	1/4	.75	7/16	2.44	.75	.92	.22	1.50	100	10
HL13-2-5	#1 STR – 2/0 STR	5/16	1.00	9/16	2.88	.81	1.07	.22	1.88	250	5
HL21-2-5	2/0 STR – 4/0 STR	3/8	1.00	9/16	3.00	1.00	1.33	.25	1.75	250	5
HL30-2-2	4/0 STR – 300 kcmil	3/8	1.00	5/8	3.13	1.06	1.45	.31	2.00	350	2
HL50-2-2	300 kcmil – 500 kcmil	3/8	1.00	3/4	3.44	1.38	1.66	.34	2.00	480	2

**Uses slotted head set screw.



Two-Hole, Straight Tongue Lug with NEMA Hole Sizes and Spacing

For Use with Copper Code Conductors

Type HL-2N

- Cast from high strength corrosion resistant copper alloy to provide premium electrical and mechanical performance
- Wide wire range-taking capability minimizes inventory requirements
- Internal pressure plate provides uniform clamping force on conductor for premium electrical performance
- Internal barrel serrations allow for premium wire pull-out strength
- Inspection window to visually assure full conductor insertion
- Flat bottom allows for complete contact with mounting surface
- UL Listed for use up to 600 V and temperature rated 90°C
- Available with NEMA hole sizes and spacing

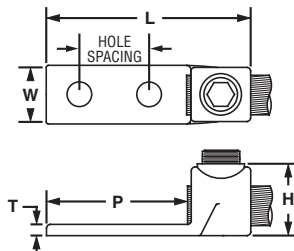

Part Number	Copper Conductor Size Range	Stud Hole Size (In.)	Stud Hole Spacing (In.)	Hex Key Size (In.)	Figure Dimensions (In.)					Tightening Torque (In.-Lbs.)	Std. Pkg. Qty.
					L	W	H	T	P		
◆ HL8-2N-X	#4 SOL – #1 STR	1/2	1.75	7/16	3.94	1.00	.90	.22	3.00	100	10
◆ HL13-2N-5	#1 STR – 2/0 STR	1/2	1.75	9/16	4.25	1.00	1.07	.22	3.00	250	5
◆ HL21-2N-5	2/0 STR – 4/0 STR	1/2	1.75	9/16	4.19	1.25	1.34	.25	3.00	250	5
◆ HL30-2N-2	4/0 STR – 300 kcmil	1/2	1.75	5/8	4.25	1.25	1.46	.31	3.00	350	2

◆NEMA hole sizes and spacing.



Two-Hole, Straight Tongue, Tandem Set Screw Lug

For Use with Copper Code Conductors

Type HHL-2N

- Cast from high strength corrosion resistant copper alloy to provide premium electrical and mechanical performance
- Double set screws provide additional wire secureness for use in heavy duty applications
- Wide wire range-taking capability minimizes inventory requirements
- Internal pressure plate provides uniform clamping force on conductor for premium electrical performance
- Internal barrel serrations allow for premium wire pull-out strength
- Inspection window to visually assure full conductor insertion
- Flat bottom allows for complete contact with mounting surface
- UL Listed for use up to 600 V and temperature rated 90°C
- Available with NEMA hole sizes and spacing

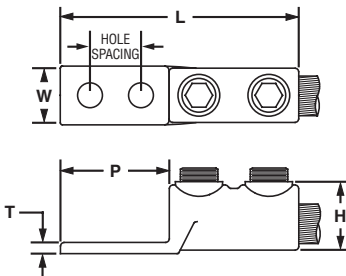

Part Number	Copper Conductor Size Range	Stud Hole Size (In.)	Stud Hole Spacing (In.)	Hex Key Size (In.)	Figure Dimensions (In.)					Tightening Torque (In.-Lbs.)	Std. Pkg. Qty.
					L	W	H	T	P		
◆ HHL8-2N-X	#4 SOL – #1 STR	1/2	1.75	7/16	5.13	1.00	.80	.22	3.00	100	10
◆ HHL13-2N-5	#1 STR – 2/0 STR	1/2	1.75	9/16	4.88	1.25	1.00	.22	3.00	250	5
◆ HHL21-2N-5	2/0 STR – 4/0 STR	1/2	1.75	9/16	5.63	1.50	1.37	.25	3.00	250	5
◆ HHL30-2N-1	4/0 STR – 300 kcmil	1/2	1.75	5/8	5.88	1.50	1.45	.31	3.00	350	1

◆NEMA hole sizes and spacing.

A. System Overview

B1. Cable Ties

B2. Cable Accessories

B3. Stainless Steel Ties

C1. Wiring Duct

C2. Surface Raceway

C3. Abrasion Protection

C4. Cable Management

D1. Terminals

D2. Power Connectors

D3. Grounding Connectors

E1. Labeling Systems

E2. Labels

E3. Pre-Printed & Write-On Markers

E4. Permanent Identification

E5. Lockout/Tagout & Safety Solutions

F. Index

A. System Overview

B1. Cable Ties

B2. Cable Accessories

B3. Stainless Steel Ties

C1. Wiring Duct

C2. Surface Raceway

C3. Abrasion Protection

C4. Cable Management

D1. Terminals

D2. Power Connectors

D3. Grounding Connectors

E1. Labeling Systems

E2. Labels

E3. Pre-Printed & Write-On Markers

E4. Permanent Identification

E5. Lockout/Tagout & Safety Solutions

F. Index

UL LISTED Two-Hole, Straight Tongue, Two-Barrel Lug

For Use with Copper Code Conductors

Type H2L-2N

- Allows for termination of two copper conductors
- Cast from high strength corrosion resistant copper alloy to provide premium electrical and mechanical performance
- Wide wire range-taking capability minimizes inventory requirements
- Internal pressure plate provides uniform clamping force on conductor for premium electrical performance
- Internal barrel serrations provide premium wire pull-out strength
- Inspection window to visually assure full conductor insertion
- Flat bottom allows for complete contact with mounting surface
- UL Listed for use up to 600 V and temperature rated 90°C
- Available with NEMA hole sizes and spacing

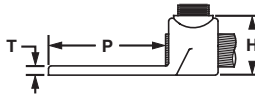
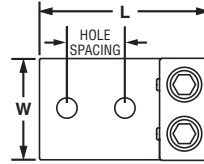

Part Number	Copper Conductor Size Range	Stud Hole Size (In.)	Stud Hole Spacing (In.)	Hex Key Size (In.)	Figure Dimensions (In.)					Tightening Torque (In.-Lbs.)	Std. Pkg. Qty.
					L	W	H	T	P		
◆ H2L4-2N-X	#8 SOL – #4 STR	1/2	1.75	**	3.75	1.25	.76	.19	3.00	35	10
◆ H2L8-2N-2	#4 SOL – #1 STR	1/2	1.75	7/16	3.94	1.38	.92	.22	3.00	100	2
◆ H2L13-2N-2	#1 STR – 2/0 STR	1/2	1.75	9/16	4.00	1.63	1.06	.22	3.00	250	2
◆ H2L21-2N-2	2/0 STR – 4/0 STR	1/2	1.75	9/16	4.19	1.88	1.34	.31	3.00	250	2
◆ H2L30-2N-1	4/0 STR – 300 kcmil	1/2	1.75	5/8	4.38	2.00	1.45	.31	3.00	350	1

**Uses slotted head set screw.
◆NEMA hole sizes and spacing.

UL LISTED Two-Hole, Straight Tongue, Two-Barrel, Tin-Plated Lug

For Use with Copper Code Conductors

Type P2NLT

- Allows for termination of two copper conductors
- Cast from high strength corrosion resistant copper alloy to provide premium electrical and mechanical performance
- Tin-plated to inhibit corrosion
- Wide wire range-taking capability minimizes inventory requirements
- Internal barrel serrations provide premium wire pull-out strength
- Inspection window to visually assure full conductor insertion
- Plated steel set screw provides high strength, durable electrical contact
- Flat bottom allows for complete contact with mounting surface
- UL Listed for use up to 600 V and temperature rated 90°C
- Available with NEMA hole sizes and spacing

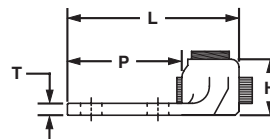
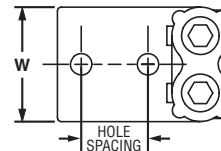

Part Number	Copper Conductor Size Range	Stud Hole Size (In.)	Stud Hole Spacing (In.)	Hex Key Size (In.)	Figure Dimensions (In.)					Tightening Torque (In.-Lbs.)	Std. Pkg. Qty.
					L	W	H	T	P		
◆ P2NLT-500-3	#4 SOL – 500 kcmil	1/2	1.75	3/8	4.50	2.50	1.47	.38	3.00	375	3

◆NEMA hole sizes and spacing.

Two-Set Screw Splice

For Use with Copper Code Conductors

Type PNLC

- Cast from high strength corrosion resistant copper alloy to provide premium electrical and mechanical performance
- Wide wire range-taking capability minimizes inventory requirements
- Plated steel set screw provides high strength, durable electrical contact between conductor and connector
- Internal wire stops to prevent over-insertion of conductor
- For use up to 600 V and temperature rated 90°C

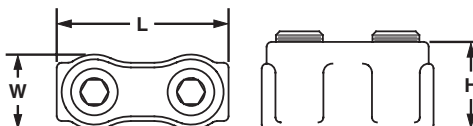

Part Number	Copper Conductor Size Range	Hex Key Size (In.)	Figure Dimensions (In.)			Tightening Torque (In.-Lbs.)	Std. Pkg. Qty.
			L	W	H		
PNLC-1/0-3	#8 SOL – 1/0 STR	1/4	1.63	.72	.84	200	3
PNLC-250-1	#6 SOL – 250 kcmil	3/8	2.13	.97	1.06	375	1
PNLC-500-1	#4 SOL – 500 kcmil	3/8	3.00	1.38	1.47	375	1



Two-Set Screw Splice with Internal Pressure Plate

For Use with Copper Code Conductors

Type HC

- Cast from high strength corrosion resistant copper alloy to provide premium electrical and mechanical performance
- Wide wire range-taking capability minimizes inventory requirements
- Internal pressure plate provides uniform clamping force on conductor for premium electrical performance
- Internal barrel serrations provide premium wire pull-out strength
- Internal wire stops to prevent over-insertion of conductor
- UL Listed for use up to 600 V and temperature rated 90°C

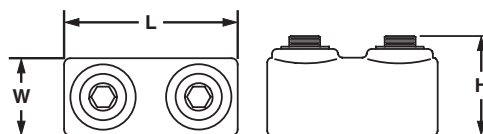

Part Number	Copper Conductor Size Range	Hex Key Size (In.)	Figure Dimensions (In)			Tightening Torque (In.-Lbs.)	Std. Pkg. Qty.
			L	W	H		
HC4-3*	#8 SOL – #4 STR	**	1.25	.50	.56	35	3
HC8-3*	#4 SOL – #1 STR	7/16	1.75	.69	.81	100	3
HC13-3	#1 STR – 2/0 STR	9/16	2.00	.81	.94	250	3
HC21-1	2/0 STR – 4/0 STR	9/16	2.25	1.00	1.19	250	1
HC30-1	4/0 STR – 300 kcmil	5/8	2.56	1.19	1.44	350	1
HC50-1	300 kcmil – 500 kcmil	3/4	3.00	1.38	1.63	480	1

*Includes swivel screws, not internal pressure plate.

**Uses slotted head set screw.

A. System Overview

B1. Cable Ties

B2. Cable Accessories

B3. Stainless Steel Ties

C1. Wiring Duct

C2. Surface Raceway

C3. Abrasion Protection

C4. Cable Management

D1. Terminals

D2. Power Connectors

D3. Grounding Connectors

E1. Labeling Systems

E2. Labels

E3. Pre-Printed & Write-On Markers

E4. Permanent Identification

E5. Lockout/Tagout & Safety Solutions

F. Index

A. System Overview

B1. Cable Ties

B2. Cable Accessories

B3. Stainless Steel Ties

C1. Wiring Duct

C2. Surface Raceway

C3. Abrasion Protection

C4. Cable Management

D1. Terminals

D2. Power Connectors

D3. Grounding Connectors

E1. Labeling Systems

E2. Labels

E3. Pre-Printed & Write-On Markers

E4. Permanent Identification

E5. Lockout/Tagout & Safety Solutions

F. Index



One-Hole, Straight Fixed Tongue Lug

For Use with Stranded Copper Code Conductors

Type CX

- Made from high strength electrolytic copper to provide premium electrical and mechanical performance
- Compact design saves space
- Wide wire range-taking capability minimizes inventory requirements
- Inspection window to visually assure full conductor insertion
- Plated steel set screw provides high strength, durable electrical contact between conductor and connector
- UL Listed and CSA Certified for use up to 600 V

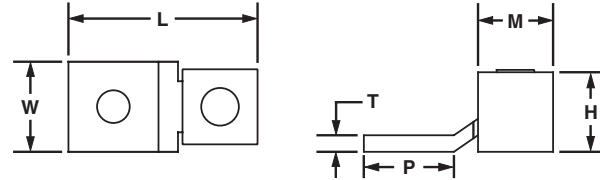

Part Number	Copper Conductor Size Range	Current Rating (Amps)	Stud Hole Size (In.)	Hex Size (In.)	Figure Dimensions (In.)						Tightening Torque (In.-Lbs.)	Std. Pkg. Qty.
					L	W	H	T	P	M		
CX35-36-CY	#14 – 6 AWG	35	3/16	**	1.02	.38	.48	.07	.44	.38	25	100
CX70-14-CY	#14 – 4 AWG, (2) #14 AWG, (2) #12 AWG	70	1/4	**	1.27	.50	.57	.08	.59	.50	35	100
CX125-14-QY	#4 – 1/0 AWG	125	1/4	**	1.53	.62	.77	.32	.84	.62	50	25
CX225-56-QY	#2 – 4/0 AWG	225	5/16	9/16	2.19	1.00	1.13	.13	1.06	1.00	50	25
CX400-38-3Y	4/0 AWG – 500 kcmil	400	3/8	3/4	3.16	1.50	1.65	.19	1.69	1.38	50	3

**Uses slotted head set screw.



One-Hole, Straight Fixed Tongue, Tin-Plated Lug

For Use with Stranded Copper Code Conductors

Type CX-T

- Made from high strength electrolytic copper to provide premium electrical and mechanical performance
- Tin-plated to inhibit corrosion
- Compact design saves space
- Wide wire range-taking capability minimizes inventory requirements
- Inspection window to visually assure full conductor insertion
- Plated steel set screw provides high strength, durable electrical contact between conductor and connector
- UL Listed and CSA Certified for use up to 600 V

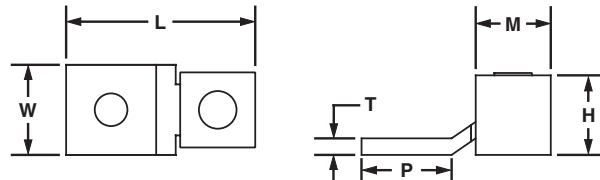

Part Number	Copper Conductor Size Range	Current Rating (Amps)	Stud Hole Size (In.)	Hex Size (In.)	Figure Dimensions (In.)						Tightening Torque (In.-Lbs.)	Std. Pkg. Qty.
					L	W	H	T	P	M		
CX35-36T-CY	#14 – 6 AWG	35	3/16	**	1.02	.38	.48	.07	.44	.38	25	100
CX70-14T-CY	#14 – 4 AWG, (2) #14 AWG, (2) #12 AWG	70	1/4	**	1.27	.50	.57	.08	.59	.50	35	100
CX125-56T-QY	#4 – 1/0 AWG	125	5/16	**	1.53	.62	.77	.13	.84	.62	50	25
CX225-38T-QY	#2 – 4/0 AWG	225	3/8	9/16	2.19	1.00	1.13	.13	1.06	1.00	50	25
CX225-56T-QY	#2 – 4/0 AWG	225	5/16	9/16	2.19	1.00	1.13	.13	1.06	1.00	50	25
CX400-12T-3Y‡‡	4/0 AWG – 500 kcmil	400	1/2	3/4	3.16	1.50	1.65	.19	1.69	1.38	50	3

**Uses slotted head set screw.

‡‡Not UL Listed or CSA Certified.



One-Hole, Straight Floating Tongue Lug

For Use with Stranded Copper Code Conductors

Type CS

- Made from high strength electrolytic copper to provide premium electrical and mechanical performance
- Wide wire range-taking capability minimizes inventory requirements
- Internal pressure bar and V-bottom collar provide uniform clamping force on conductor to assure positive contact between conductor and connector
- Inspection window to visually assure full conductor insertion
- Plated steel set screw provides high strength, durable electrical contact between conductor and connector
- UL Listed and CSA Certified for use up to 600 V

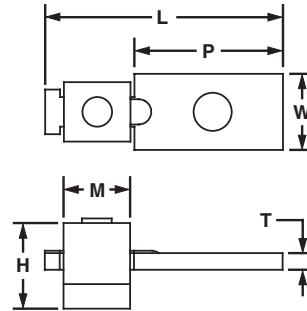

Part Number	Copper Conductor Size Range	Current Rating (Amps)	Stud Hole Size (In.)	Hex Size (In.)	Figure Dimensions (In.)						Tightening Torque (In.-Lbs.)	Std. Pkg. Qty.
					L	W	H	T	P	M		
CS25-18-CY	#14 – 10 AWG	25	1/8	**	1.16	.32	.37	.07	.75	.28	45	100
CS35-36-CY	#14 – 6 AWG, (2) #10 AWG, (2) #12 AWG, (2) #14 AWG, (1) #10 AWG with (1) #12 AWG, (1) #12 AWG with (1) #14 AWG	50	3/16	**	1.14	.38	.52	.07	.60	.44	120	100
CSA70-14-CY	#14 – 4 AWG	70	1/4	**	1.30	.50	.56	.08	.71	.42	200	100
CS70-14-CY	#12 AWG – 1 AWG, (1) #8 AWG with (1) #4 AWG, (1) #8 AWG with (1) #6 AWG	90	1/4	**	1.50	.50	.65	.08	.81	.50	200	100
CS125-14-QY	#2 – 1/0 AWG	125	1/4	**	1.94	.62	.88	.13	1.00	.62	200	25
CS175-38-QY	#4 – 3/0 AWG	175	3/8	9/16	2.19	.75	1.04	.16	1.25	.75	375	25
CS225-56-QY	#6 – 4/0 AWG	225	5/16	5/8	2.38	1.00	1.13	.13	1.19	1.00	275	25
CS300-38-QY	#1 AWG – 350 kcmil	300	3/8	3/4	3.19	1.00	1.38	.19	1.63	1.23	375	25
CS400-38-3Y	1/0 AWG – 500 kcmil	400	3/8	3/4	3.88	1.50	1.56	.19	2.19	1.50	375	3
CS650-12-3Y	600 kcmil – 1000 kcmil	650	1/2	1 1/8	5.13	2.00	2.34	.25	2.82	1.87	500	3

**Uses slotted head set screw.

A. System Overview

B1. Cable Ties

B2. Cable Accessories

B3. Stainless Steel Ties

C1. Wiring Duct

C2. Surface Raceway

C3. Abrasion Protection

C4. Cable Management

D1. Terminals

D2. Power Connectors

D3. Grounding Connectors

E1. Labeling Systems

E2. Labels

E3. Pre-Printed & Write-On Markers

E4. Permanent Identification

E5. Lockout/Tagout & Safety Solutions

F. Index

A. System Overview

B1. Cable Ties



Two-Hole, Straight Floating Tongue Lug

For Use with Stranded Copper Code Conductors

Type CD

- Made from high strength electrolytic copper to provide premium electrical and mechanical performance
- Wide wire range-taking capability minimizes inventory requirements
- Internal pressure bar and V-bottom collar provide uniform clamping force on conductor to assure positive contact between conductor and connector
- Inspection window to visually assure full conductor insertion
- Plated steel set screw provides high strength, durable electrical contact between conductor and connector
- UL Listed and CSA Certified for use up to 600 V
- Available with NEMA hole sizes and spacing

B2. Cable Accessories

B3. Stainless Steel Ties

C1. Wiring Duct

C2. Surface Raceway

C3. Abrasion Protection

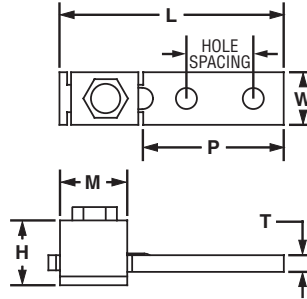

C4. Cable Management

D1. Terminals

D2. Power Connectors

D3. Grounding Connectors

E1. Labeling Systems

E2. Labels

E3. Pre-Printed & Write-On Markers

E4. Permanent Identification

E5. Lockout/Tagout & Safety Solutions

F. Index

Part Number	Copper Conductor Size Range	Current Rating (Amps)	Stud Hole Size (In.)	Stud Hole Spacing (In.)	Hex Size (In.)	Figure Dimensions (In.)						Tightening Torque (In.-Lbs.)	Std. Pkg. Qty.
						L	W	H	T	P	M		
CD35-36-QY	#14 – 6 AWG, (2) #10 AWG, (2) #12 AWG, (2) #14 AWG, (1) #10 AWG with (1) #12 AWG, (1) #12 AWG with (1) #14 AWG	50	3/16	1.00	**	2.13	.38	.52	.07	1.60	.44	120	25
CD70-14-QY	#12 – 2 AWG	90	1/4	1.00	**	2.26	.50	.65	.09	1.63	.50	200	25
CD125-14-QY	#8 – 2/0 AWG	125	1/4	1.00	**	2.94	.62	.88	.13	1.88	.62	200	25
CD225-56-QY	#6 – 4/0 AWG	225	5/16	1.00	5/8	3.38	1.00	1.17	.13	2.13	1.00	275	25
CD300-38-3Y	#1 AWG – 350 kcmil	300	3/8	1.00	3/4	4.94	1.00	1.39	.19	3.32	1.23	375	3
CD400-38-3Y	1/0 AWG – 500 kcmil	400	3/8	1.75	3/4	5.62	1.50	1.56	.19	3.57	1.50	375	3
◆ CD650-12-3Y	600 kcmil – 1000 kcmil	650	1/2	1.75	1 1/8	6.88	2.00	2.34	.25	4.69	1.88	500	3

**Uses slotted head set screw.
◆NEMA hole sizes and spacing.

UL LISTED CERTIFIED One-Hole, Offset Floating Tongue Lug

For Use with Stranded Copper Code Conductors

Type CB

- Made from high strength electrolytic copper to provide premium electrical and mechanical performance
- Wide wire range-taking capability minimizes inventory requirements
- Internal pressure bar and V-bottom collar provide uniform clamping force on conductor to assure positive contact between conductor and connector

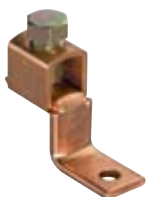

- Inspection window to visually assure full conductor insertion
- Plated steel set screw provides high strength, durable electrical contact between conductor and connector
- UL Listed and CSA Certified for use up to 600 V

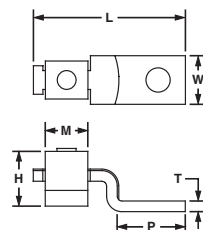

Part Number	Copper Conductor Size Range	Current Rating (Amps)	Stud Hole Size (In.)	Hex Size (In.)	Figure Dimensions (In.)						Tightening Torque (In.-Lbs.)	Std. Pkg. Qty.
					L	W	H	T	P	M		
CB25-18-CY	#14 – 10 AWG	25	1/8	**	1.00	.32	.37	.07	.44	.28	45	100
CB35-36-CY	#14 – 6 AWG, (2) #10 AWG, (2) #12 AWG, (2) #14 AWG, (1) #10 AWG with (1) #12 AWG, (1) #12 AWG with (1) #14 AWG	50	3/16	**	1.19	.38	.52	.07	.47	.44	120	100
CBA70-14-CY	#14 – 4 AWG	70	1/4	**	1.31	.50	.58	.08	.57	.43	200	100
CB70-14-CY	#12 – 2 AWG, (1) #8 AWG with (1) #4 AWG, (1) #8 AWG with (1) #6 AWG	90	1/4	**	1.55	.50	.65	.09	.66	.49	200	100
CB125-14-QY	#2 – 1/0 AWG	125	1/4	**	1.97	.63	.88	.13	.93	.62	200	25
CB175-38-QY	#4 – 3/0 AWG	175	3/8	5/16	2.19	.75	1.04	.16	.94	.74	375	25
CB225-56-QY	#6 – 4/0 AWG	225	5/16	5/8	2.38	1.00	1.17	.13	1.06	1.00	275	25
CB300-38-QY	#1 AWG – 350 kcmil	300	3/8	3/4	3.16	1.00	1.41	.19	1.50	1.23	375	25
CB400-38-3Y	1/0 AWG – 500 kcmil	400	3/8	3/4	4.25	1.50	1.57	.19	2.02	1.50	375	3
CB650-12-3Y	600 kcmil – 1000 kcmil	650	1/2	1 1/8	4.63	2.00	2.34	.25	2.04	1.84	500	3

**Uses slotted head set screw.

UL LISTED CERTIFIED One-Hole, Offset Floating Tongue, Two-Barrel Lug

For Use with Stranded Copper Code Conductors

Type DC

- Dual barrel provides termination of two copper conductors
- Made from high strength electrolytic copper to provide premium electrical and mechanical performance
- Wide wire range-taking capability minimizes inventory requirements
- Internal pressure bar and V-bottom collar provide uniform clamping force on conductor to assure positive contact between conductor and connector



- Inspection window to visually assure full conductor insertion
- Plated steel set screw provides high strength, durable electrical contact between conductor and connector
- UL Listed and CSA Certified for use up to 600 V

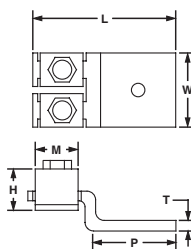

Part Number	Copper Conductor Size Range	Current Rating (Amps)	Stud Hole Size (In.)	Hex Size (In.)	Figure Dimensions (In.)						Tightening Torque (In.-Lbs.)	Std. Pkg. Qty.
					L	W	H	T	P	M		
DC450-38-3Y	#6 – 4/0 AWG	450	3/8	5/8	3.40	1.50	1.13	.19	1.94	1.00	375	3
DC600-38-3Y	#1 AWG – 350 kcmil	600	3/8	3/4	3.50	1.75	1.39	.19	1.76	1.23	375	3
DC800-12-3Y	1/0 AWG – 500 kcmil	800	1/2	3/4	4.43	2.00	1.13	.25	2.09	1.50	500	3

A. System Overview

B1. Cable Ties

B2. Cable Accessories

B3. Stainless Steel Ties

C1. Wiring Duct

C2. Surface Raceway

C3. Abrasion Protection

C4. Cable Management

D1. Terminals

D2. Power Connectors

D3. Grounding Connectors

E1. Labeling Systems

E2. Labels

E3. Pre-Printed & Write-On Markers

E4. Permanent Identification

E5. Lockout/Tagout & Safety Solutions

F. Index

A. System Overview



Two-Hole, Offset Floating Tongue Lug

For Use with Stranded Copper Code Conductors

B1. Cable Ties

Type CO

- Made from high strength electrolytic copper to provide premium electrical and mechanical performance
- Wide wire range-taking capability minimizes inventory requirements
- Internal pressure bar and V-bottom collar provide uniform clamping force on conductor to assure positive contact between conductor and connector
- Inspection window to visually assure full conductor insertion
- Plated steel set screw provides high strength, durable electrical contact between conductor and connector
- UL Listed and CSA Certified for use up to 600 V
- Available with NEMA hole sizes and spacing

B2. Cable Accessories

B3. Stainless Steel Ties

C1. Wiring Duct

C2. Surface Raceway

C3. Abrasion Protection

C4. Cable Management

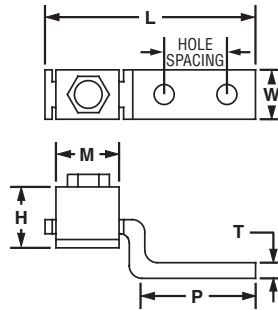

D1. Terminals

D2. Power Connectors

D3. Grounding Connectors

Part Number	Copper Conductor Size Range	Current Rating (Amps)	Stud Hole Size (In.)	Stud Hole Spacing (In.)	Hex Size (In.)	Figure Dimensions (In.)						Tightening Torque (In.-Lbs.)	Std. Pkg. Qty.
						L	W	H	T	P	M		
CO35-36-QY	#14 – 6 AWG, (2) #10 AWG, (2) #12 AWG, (2) #14 AWG, (1) #10 AWG with (1) #12 AWG, (1) #12 AWG with (1) #14 AWG	50	3/16	1.00	**	2.19	.38	.52	.07	1.50	.44	120	25
CO70-14-QY	#12 – 1 AWG, (1) #8 AWG with (1) #4 AWG, (1) #8 AWG with (1) #6 AWG	90	1/4	1.00	**	2.50	.50	.65	.09	1.66	.50	200	25
CO125-14-QY	#2 – 1/0 AWG	125	1/4	1.00	**	2.97	.63	.88	.13	1.88	.63	200	25
CO225-56-QY	#6 – 4/0 AWG	225	5/16	1.00	5/8	3.62	1.00	1.12	.13	2.27	1.00	275	25
CO300-38-3Y	#1 AWG – 350 kcmil	300	3/8	1.87	3/4	5.69	1.00	1.39	.19	4.01	1.23	375	3
CO400-38-3Y	1/0 AWG – 500 kcmil	400	3/8	1.75	3/4	6.00	1.50	1.56	.19	3.77	1.53	375	3
◆ CO650-12-3Y	600 kcmil – 1000 kcmil	650	1/2	1.75	1 1/8	6.25	2.00	2.34	.25	3.69	1.88	500	3

**Uses slotted head set screw.

◆NEMA hole sizes and spacing.

E1. Labeling Systems

E2. Labels

E3. Pre-Printed & Write-On Markers

E4. Permanent Identification

E5. Lockout/Tagout & Safety Solutions

F. Index

UL LISTED **CSA CERTIFIED** **One-Hole, Single Barrel Lug**

For Use with Stranded Aluminum or Copper Code Conductors

Type LAMA

- Made from high strength, extruded aluminum alloy to provide premium electrical and mechanical performance
- Tin-plated to inhibit corrosion
- Compact design saves space
- Wide wire range-taking capability minimizes inventory requirements

- Inspection window to visually assure full conductor insertion
- Plated steel or aluminum set screw provides high strength, durable electrical contact between conductor and connector
- UL Listed and CSA Certified for use up to 600 V and UL temperature rated 90°C

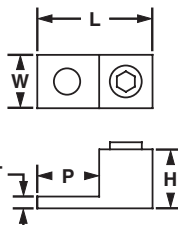

Part Number	Conductor Size Range	Stud Hole Size (In.)	Hex Key Size (In.)	Figure Dimensions (In.)					Tightening Torque (In.-Lbs.)	Std. Pkg. Qty.
				L	W	H	T	P		
LAMA6-14-QY	#14 – 6 AWG	1/4	**	1.06	.38	.50	.09	.68	45*	25
LAMA2-14-QY	#14 – 2 AWG	1/4	**	1.16	.50	.56	.09	.69	50*	25
LAMA1/0-14-QY	#14 – 1/0 AWG	1/4	**	1.47	.62	.81	.19	.84	50*	25
LAMA2/0-14-QY	#14 – 2/0 AWG	1/4	**	1.47	.62	.81	.19	.84	50*	25
LAMA250-56-QY	#6 AWG – 250 kcmil	5/16	3/8	2.00	.90	1.06	.22	1.00	375*	25
LAMA300-56-QY	#6 AWG – 300 kcmil	5/16	3/8	2.00	.90	1.06	.22	1.00	375*	25
LAMA350-38-QY	#6 AWG – 350 kcmil	3/8	3/8	2.25	1.13	1.25	.25	1.13	375*	25
LAMA500-38-6Y	#4 AWG – 500 kcmil	3/8	1/2	2.75	1.38	1.50	.31	1.50	500	6
LAMA600-38-6Y	#4 AWG – 600 kcmil	3/8	1/2	2.75	1.38	1.50	.31	1.50	500	6
LAMA600S-38-6Y***	#4 AWG – 600 kcmil or (2) 1/0 AWG – 250 kcmil	3/8	1/2	2.81	1.38	1.81	.31	1.50	500	6
LAMA800-58-6Y	350 kcmil – 800 kcmil	5/8	9/16	3.38	1.63	1.94	.38	1.75	600	6
LAMA1000-58-6Y	500 kcmil – 1000 kcmil	5/8	9/16	3.50	1.75	2.13	.44	1.75	600	6

The use of PANDUIT oxide inhibiting joint compound (CMP-100) is recommended for pad to pad and conductor connections. See page D2.161.

*Listed torque values are for maximum conductor sizes, consult the installation instruction sheet for smaller sizes.

**Uses slotted head set screw.

***Accommodates two conductors for conductor range 1/0 AWG – 250 kcmil.

A. System Overview

B1. Cable Ties

B2. Cable Accessories

B3. Stainless Steel Ties

C1. Wiring Duct

C2. Surface Raceway

C3. Abrasion Protection

C4. Cable Management

D1. Terminals

D2. Power Connectors

D3. Grounding Connectors

E1. Labeling Systems

E2. Labels

E3. Pre-Printed & Write-On Markers

E4. Permanent Identification

E5. Lockout/Tagout & Safety Solutions

F. Index

A. System Overview



Two-Hole, Single Barrel Lug

For Use with Stranded Aluminum or Copper Code Conductors

B1. Cable Ties

Type LAMB

- Made from high strength, extruded aluminum alloy to provide premium electrical and mechanical performance
- Tin-plated to inhibit corrosion
- Compact design saves space
- Wide wire range-taking capability minimizes inventory requirements
- Inspection window to visually assure full conductor insertion

- Plated steel or aluminum set screw provides high strength, durable electrical contact between conductor and connector
- LAMLB provided with dual set screws for premium clamping of conductor to connector for heavy duty applications
- UL Listed and CSA Certified for use up to 600 V and UL temperature rated 90°C
- Available with NEMA hole sizes and spacing

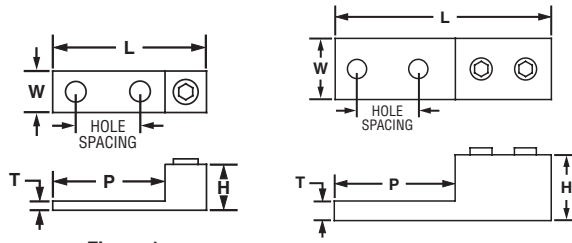

Figure 1

Figure 2

B2. Cable Accessories

C1. Wiring Duct

C2. Surface Raceway

C3. Abrasion Protection

C4. Cable Management

Part Number	Figure No.	Conductor Size Range	Stud Hole Size (In.)	Stud Hole Spacing (In.)	Hex Key Size (In.)	Figure Dimensions (In.)					Tightening Torque (In.-Lbs.)	Std. Pkg. Qty.
						L	W	H	T	P		
◆ LAMB350-12-6Y	1	#6 AWG – 350 kcmil	1/2	1.75	3/8	4.19	1.13	1.25	.25	3.06	#6 – 2 AWG – 200 kcmil, #1 AWG – 350 kcmil – 375 kcmil	6
◆ LAMB600-12-3Y	1	#4 AWG – 600 kcmil	1/2	1.75	1/2	4.69	1.50	1.56	.44	3.31	500	3
◆ LAMLB800-12-3Y	2	350 kcmil – 800 kcmil	1/2	1.75	3/8	6.19	1.75	1.88	.56	3.44	375	3

The use of PANDUIT oxide inhibiting joint compound (CMP-100) is recommended for pad to pad and conductor connections. See page D2.161.
◆NEMA hole sizes and spacing.

D1. Terminals



One-Hole, Two-Barrel Lug

For Use with Stranded Aluminum or Copper Code Conductors

D2. Power Connectors

Type LAM2A

- Dual barrel provides termination of two conductors
- Made from high strength, extruded aluminum alloy to provide premium electrical and mechanical performance
- Tin-plated to inhibit corrosion
- Wide wire range-taking capability minimizes inventory requirements
- Inspection window to visually assure full conductor insertion

- Plated steel or aluminum set screw provides high strength, durable electrical contact between conductor and connector
- UL Listed and CSA Certified for use up to 600 V and UL temperature rated 90°C
- Available with NEMA hole sizes and spacing

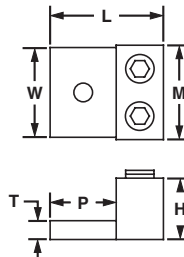

E1. Labeling Systems

E2. Labels

E3. Pre-Printed & Write-On Markers

E4. Permanent Identification

E5. Lockout/Tagout & Safety Solutions

Part Number	Conductor Size Range	Stud Hole Size (In.)	Hex Key Size (In.)	Figure Dimensions (In.)						Tightening Torque (In.-Lbs.)	Std. Pkg. Qty.
				L	W	H	T	P	M		
Λ LAM2A1/0-14-6Y	#14 – 1/0 AWG	1/4	**	1.47	1.12	.81	.19	.85	1.12	45*	6
Λ LAM2A2/0-14-6Y	#14 – 2/0 AWG	1/4	**	1.47	1.20	.81	.19	.85	1.20	50*	6
Λ LAM2A250-38-6Y	#6 AWG – 250 kcmil	3/8	3/8	2.56	1.50	1.19	.25	1.56	1.62	375	6
Λ LAM2A350-12-6Y	#6 AWG – 350 kcmil	1/2	3/8	2.88	1.75	1.25	.25	1.75	1.94	375*	6
Λ LAM2A600-12-6Y	#4 AWG – 600 kcmil	1/2	1/2	3.13	2.00	1.56	.44	1.75	2.38	500	6
Λ LAM2A800-58-6Y	350 kcmil – 800 kcmil	5/8	7/16	3.50	2.81	.69	.50	2.00	2.81	500	6
▼ LAM2A1000-58-6Y	500 kcmil – 1000 kcmil	5/8	3/8	3.50	2.87	1.69	.50	2.00	2.87	500	6

The use of PANDUIT oxide inhibiting joint compound (CMP-100) is recommended for pad to pad and conductor connections. See page D2.161.

*Listed torque values are for maximum conductor sizes, consult the installation instruction sheet for smaller sizes.

**Uses slotted head set screw.

ΛNot CSA Certified.

▼Not UL Listed or CSA Certified.

F. Index

UL LISTED CERTIFIED One-Hole, Vertical Two-Barrel Lug

For Use with Stranded Aluminum or Copper Code Conductors

Type LAM2SA

- Dual barrel provides termination of two conductors
- Made from high strength, extruded aluminum alloy to provide premium electrical and mechanical performance
- Tin-plated to inhibit corrosion
- Wide wire range-taking capability minimizes inventory requirements



- Inspection window to visually assure full conductor insertion
- Plated steel or aluminum set screw provides high strength, durable electrical contact between conductor and connector
- UL Listed and CSA Certified for use up to 600 V and UL temperature rated 90°C

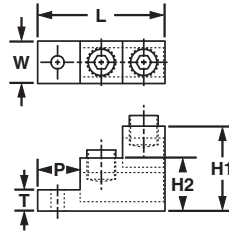

Part Number	Conductor Size Range	Stud Hole Size (In.)	Hex Key Size (In.)	Figure Dimensions (In.)						Tightening Torque (In.-Lbs.)	Std. Pkg. Qty.
				L	W	H1	H2	T	P		
LAM2SA300-56-3	#6 AWG – 300 kcmil	5/16	5/16	3.00	1.00	2.00	1.25	.50	1.00	375*	3

The use of PANDUIT oxide inhibiting joint compound (CMP-100) is recommended for pad to pad and conductor connections. See page D2.161.
*Listed torque values are for maximum conductor sizes, consult the installation instruction sheet for smaller sizes.

UL LISTED Two-Hole, Two-Barrel Lug

For Use with Stranded Aluminum or Copper Code Conductors

Type LAM2B

- Dual barrel provides termination of two conductors
- Made from high strength, extruded aluminum alloy to provide premium electrical and mechanical performance
- Tin-plated to inhibit corrosion
- Wide wire range-taking capability minimizes inventory requirements
- Inspection window to visually assure full conductor insertion



- Plated steel or aluminum set screw provides high strength, durable electrical contact between conductor and connector
- LAM2LB connector provided with dual set screws for premium clamping of conductor to connector for heavy duty applications
- UL Listed for use up to 600 V and temperature rated 90°C
- Available with NEMA hole sizes and spacing

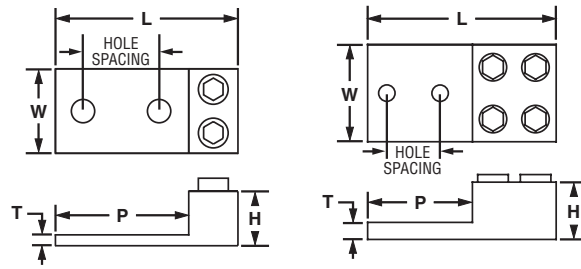

Figure 1

Figure 2

Part Number	Figure No.	Conductor Size Range	Stud Hole Size (In.)	Stud Hole Spacing (In.)	Hex Key Size (In.)	Figure Dimensions (In.)					Tightening Torque (In.-Lbs.)	Std. Pkg. Qty.
						L	W	H	T	P		
◆ LAM2B350-12-3Y	1	#6 AWG – 350 kcmil	1/2	1.75	3/8	4.19	1.94	1.25	.25	3.06	375**	3
◆ LAM2B600-12-3Y	1	#4 AWG – 600 kcmil	1/2	1.75	1/2	4.69	2.44	1.56	.44	3.31	500	3
◆ LAM2LB800-12-3Y*	2	350 kcmil – 800 kcmil	1/2	1.75	3/8	6.19	3.19	1.88	.56	3.44	500	3

The use of PANDUIT oxide inhibiting joint compound (CMP-100) is recommended for pad to pad and conductor connections. See page D2.161.

*Not UL Listed.

**Listed torque values are for maximum conductor sizes, consult the installation instruction sheet for smaller sizes.

◆NEMA hole sizes and spacing.

A. System Overview

B1. Cable Ties

B2. Cable Accessories

B3. Stainless Steel Ties

C1. Wiring Duct

C2. Surface Raceway

C3. Abrasion Protection

C4. Cable Management

D1. Terminals

D2. Power Connectors

D3. Grounding Connectors

E1. Labeling Systems

E2. Labels

E3. Pre-Printed & Write-On Markers

E4. Permanent Identification

E5. Lockout/Tagout & Safety Solutions

F. Index

A. System Overview



Two-Hole, Vertical Two-Barrel Lug

For Use with Stranded Aluminum or Copper Code Conductors

B1. Cable Ties

Type LAM2SB

- Dual barrel provides termination of two conductors
- Vertical configuration saves space
- Made from high strength, extruded aluminum alloy to provide premium electrical and mechanical performance
- Tin-plated to inhibit corrosion
- Wide wire range-taking capability minimizes inventory requirements

- Inspection window to visually assure full conductor insertion
- Plated steel or aluminum set screw provides high strength, durable electrical contact between conductor and connector
- UL Listed and CSA Certified for use up to 600 V and UL temperature rated 90°C

B2. Cable Accessories

B3. Stainless Steel Ties

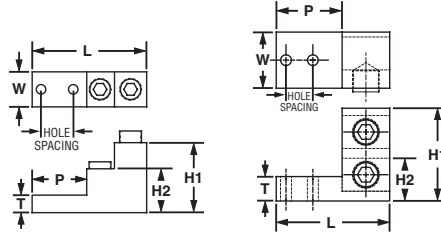

C1. Wiring Duct

C2. Surface Raceway

Part Number	Figure No.	Conductor Size Range	Stud Hole Size (In.)	Stud Hole Spacing (In.)	Hex Key Size (In.)	Figure Dimensions (In.)						Tightening Torque (In.-Lbs.)	Std. Pkg. Qty.
						L	W	H1	H2	T	P		
LAM2SB600-38-1Y*	1	#2 AWG – 600 kcmil	3/8	1.38	1/2	4.91	1.50	3.00	1.88	.75	2.34	500	1
LAM2SB750-38-1Y*	1	3/0 AWG – 750 kcmil	3/8	1.38	1/2	4.91	1.50	3.00	1.88	.75	2.34	500	1
LAM2SSB500-141Y	2	4/0 AWG – 500 kcmil	1/4	.69	3/8	2.91	1.44	2.38	1.77	.63	1.69	375	1

The use of PANDUIT oxide inhibiting joint compound (CMP-100) is recommended for pad to pad and conductor connections. See page D2.161.
*Not CSA Certified.

C3. Abrasion Protection

C4. Cable Management

Two-Hole, Three-Barrel Lug

For Use with Stranded Aluminum or Copper Code Conductors

Type LAM3B

- Triple barrel provides termination of three conductors
- Made from high strength, extruded aluminum alloy to provide premium electrical and mechanical performance
- Tin-plated to inhibit corrosion
- Wide wire range-taking capability minimizes inventory requirements
- Inspection window to visually assure full conductor insertion
- Plated steel or aluminum set screw provides high strength, durable electrical contact between conductor and connector

- LAM3LB connector is provided with dual set screws to allow premium clamping of conductor to connector for heavy duty applications
- For use up to 600 V and temperature rated 90°C
- Available with NEMA hole sizes and spacing

D1. Terminals

D2. Power Connectors

D3. Grounding Connectors

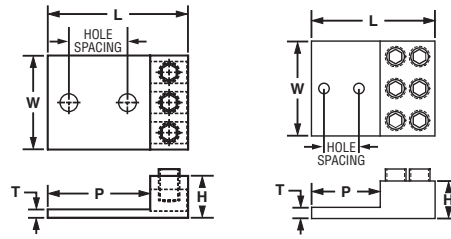

E1. Labeling Systems

E2. Labels

Part Number	Figure No.	Conductor Size Range	Stud Hole Size (In.)	Stud Hole Spacing (In.)	Hex Key Size (In.)	Figure Dimensions (In.)					Tightening Torque (In.-Lbs.)	Std. Pkg. Qty.
						L	W	H	T	P		
LAM3B2-14-6Y	1	#14 – 2 AWG	5/16	.87	**	2.49	1.63	.47	.19	2.03	50*	6
LAM3B1/0-38-6Y	1	#12 – 1/0 AWG	3/8	1.00	**	2.94	1.94	.63	.19	2.31	50*	6
◆ LAM3B3/0-12-3Y	1	#6 – 3/0 AWG	1/2	1.75	5/16	4.19	2.81	.81	.25	3.38	200	3
◆ LAM3B250-12-1Y	1	#6 AWG – 250 kcmil	1/2	1.75	5/16	4.19	2.81	1.25	.25	3.06	375*	1
◆ LAM3B350-12-1Y	1	#6 AWG – 350 kcmil	1/2	1.75	5/16	4.19	3.00	1.25	.25	3.06	375*	1
◆ LAM3B600-12-1Y	1	# 2 AWG – 600 kcmil	1/2	1.75	1/2	4.69	3.75	1.56	.44	3.31	375	1
◆ LAM3LB800-12-1Y	2	350 kcmil – 800 kcmil	1/2	1.75	3/8	6.19	4.25	1.88	.56	3.44	375	1
◆ LAM3LB1000-121Y	2	500 kcmil – 1000 kcmil	1/2	1.75	3/8	6.19	4.75	1.88	.56	3.44	375	1

The use of PANDUIT oxide inhibiting joint compound (CMP-100) is recommended for pad to pad and conductor connections. See page D2.161.

*Listed torque values are for maximum conductor sizes, consult the installation instruction sheet for smaller sizes.

**Uses slotted head set screw.

◆NEMA hole sizes and spacing.

E3. Pre-Printed & Write-On Markers

E4. Permanent Identification

E5. Lockout/Tagout & Safety Solutions

F. Index



Two-Hole, Vertical Three-Barrel Lug

For Use with Stranded Aluminum or Copper Code Conductors

Type LAM3SB

- Triple barrel provides termination of three conductors
- Vertical configuration saves space
- Made from high strength, extruded aluminum alloy to provide premium electrical and mechanical performance
- Tin-plated to inhibit corrosion



- Wide wire range-taking capability minimizes inventory requirements
- Inspection window to visually assure full conductor insertion
- Plated steel or aluminum set screw provides high strength, durable electrical contact between conductor and connector
- UL Listed and CSA Certified for use up to 600 V and UL temperature rated 90°C

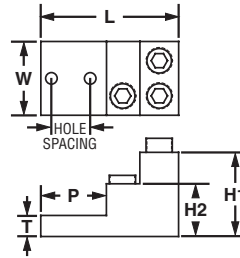

Part Number	Conductor Size Range	Stud Hole Size (In.)	Stud Hole Spacing (In.)	Hex Key Size (In.)	Figure Dimensions (In.)						Tightening Torque (In.-Lbs.)	Std. Pkg. Qty.
					L	W	H1	H2	T	P		
LAM3SB600-38-1Y	#2 AWG – 600 kcmil	3/8	1.38	1/2	4.91	2.47	3.00	1.88	.75	2.34	500	1
LAM3SB750-38-1Y	3/0 AWG – 750 kcmil	3/8	1.38	1/2	4.91	2.63	3.00	1.88	.75	2.34	500	1

The use of PANDUIT oxide inhibiting joint compound (CMP-100) is recommended for pad to pad and conductor connections. See page D2.161.

Four-Hole, Three-Barrel Lug

For Use with Stranded Aluminum or Copper Code Conductors

Type LAM3D

- Triple barrel provides termination of three conductors
- Made from high strength, extruded aluminum alloy to provide premium electrical and mechanical performance
- Tin-plated to inhibit corrosion
- Wide wire range-taking capability minimizes inventory requirements
- Inspection window to visually assure full conductor insertion



- Plated steel or aluminum set screw provides high strength, durable electrical contact between conductor and connector
- LAM3LD connector is provided with dual set screws to allow premium clamping of conductor to connector for heavy duty applications
- For use up to 600 V and temperature rated 90°C
- Available with NEMA hole sizes and spacing

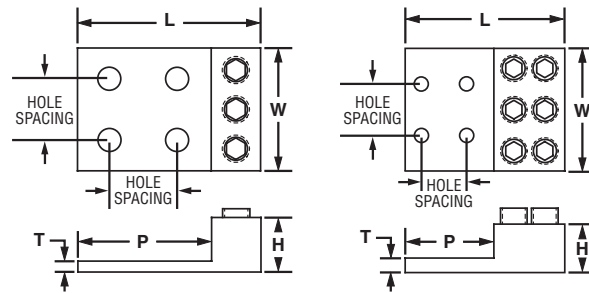

Figure 1

Figure 2

Part Number	Figure No.	Conductor Size Range	Stud Hole Size (In.)	Stud Hole Spacing (In.)	Hex Key Size (In.)	Figure Dimensions (In.)					Tightening Torque (In.-Lbs.)	Std. Pkg. Qty.
						L	W	H	T	P		
◆ LAM3D3/0-12-3Y	1	#6 – 3/0 AWG	1/2	1.75	1/4	4.19	2.81	.81	.25	3.38	200	3
◆ LAM3D250-12-1Y	1	#6 AWG – 250 kcmil	1/2	1.75	1/4	4.19	2.81	1.25	.25	3.07	375*	1
◆ LAM3D350-12-1Y	1	#6 AWG – 350 kcmil	1/2	1.75	5/16	4.19	3.00	1.25	.25	3.06	375*	1
◆ LAM3D600-12-1Y	1	#2 AWG – 600 kcmil	1/2	1.75	3/8	4.69	3.75	1.56	.44	3.31	500	1
◆ LAM3LD800-12-1Y	2	350 kcmil – 800 kcmil	1/2	1.75	3/8	6.19	4.25	1.88	.56	3.44	375	1
◆ LAM3LD1000-121Y	2	500 kcmil – 1000 kcmil	1/2	1.75	9/16	6.19	4.75	1.88	.56	3.44	600	1

The use of PANDUIT oxide inhibiting joint compound (CMP-100) is recommended for pad to pad and conductor connections. See page D2.161.

*Listed torque values are for maximum conductor sizes, consult the installation instruction sheet for smaller sizes.

◆NEMA hole sizes and spacing.

A. System Overview

B1. Cable Ties

B2. Cable Accessories

B3. Stainless Steel Ties

C1. Wiring Duct

C2. Surface Raceway

C3. Abrasion Protection

C4. Cable Management

D1. Terminals

D2. Power Connectors

D3. Grounding Connectors

E1. Labeling Systems

E2. Labels

E3. Pre-Printed & Write-On Markers

E4. Permanent Identification

E5. Lockout/Tagout & Safety Solutions

F. Index

A. System Overview



Two-Hole, Vertical Four-Barrel Lug

For Use with Stranded Aluminum or Copper Code Conductors

B1. Cable Ties

Type LAM4SB

- Four barrels provide termination of four conductors
- Vertical configuration saves space
- Made from high strength, extruded aluminum alloy to provide premium electrical and mechanical performance
- Tin-plated to inhibit corrosion
- Wide wire range-taking capability minimizes inventory requirements
- Inspection window to visually assure full conductor insertion
- Plated steel or aluminum set screw provides high strength, durable electrical contact between conductor and connector
- UL Listed and CSA Certified for use up to 600 V and UL temperature rated 90°C

B2. Cable Accessories

B3. Stainless Steel Ties



C1. Wiring Duct

C2. Surface Raceway

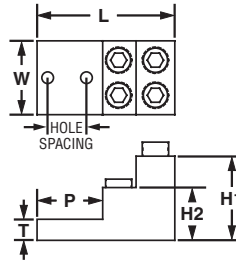

C3. Abrasion Protection

Part Number	Conductor Size Range	Stud Hole Size (In.)	Stud Hole Spacing (In.)	Hex Key Size (In.)	Figure Dimensions (In.)						Tightening Torque (In.-Lbs.)	Std. Pkg. Qty.
					L	W	H1	H2	T	P		
LAM4SB600-38-1Y	#2 AWG – 600 kcmil	3/8	1.38	1/2	4.91	2.47	3.00	1.88	.75	2.34	500	1
LAM4SB750-38-1Y	1/0 AWG – 750 kcmil	3/8	1.38	1/2	4.91	2.63	3.00	1.88	.75	2.34	500	1

The use of PANDUIT oxide inhibiting joint compound (CMP-100) is recommended for pad to pad and conductor connections. See page D2.161.

C4. Cable Management

Four-Hole, Four-Barrel Lug

For Use with Stranded Aluminum or Copper Code Conductors

D1. Terminals

Type LAM4D

- Four barrels provide termination of four conductors
- Made from high strength, extruded aluminum alloy to provide premium electrical and mechanical performance
- Tin-plated to inhibit corrosion
- Wide wire range-taking capability minimizes inventory requirements
- Inspection window to visually assure full conductor insertion
- Plated steel or aluminum set screw provides high strength, durable electrical contact between conductor and connector
- LAM4LD connector is provided with dual set screws to allow premium clamping of conductor to connector for heavy duty applications
- For use up to 600 V and temperature rated 90°C
- Available with NEMA hole sizes and spacing

D2. Power Connectors

D3. Grounding Connectors

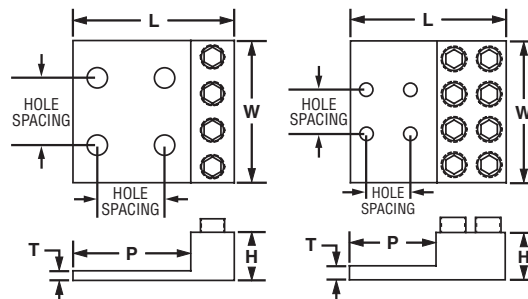

E1. Labeling Systems

E2. Labels

E3. Pre-Printed & Write-On Markers



E4. Permanent Identification

Part Number	Figure No.	Conductor Size Range	Stud Hole Size (In.)	Stud Hole Spacing (In.)	Hex Key Size (In.)	Figure Dimensions (In.)					Tightening Torque (In.-Lbs.)	Std. Pkg. Qty.
						L	W	H	T	P		
◆ LAM4D250-12-1Y	1	# 6 AWG – 250 kcmil	1/2	1.75	3/8	4.19	3.69	1.00	.25	3.06	375*	1
◆ LAM4D350-12-1Y	1	# 6 AWG – 350 kcmil	1/2	1.75	5/16	4.19	3.94	1.25	.25	3.06	275	1
◆ LAM4D600-12-1Y	1	# 2 AWG – 600 kcmil	1/2	1.75	3/8	4.69	5.00	1.56	.44	3.31	500	1
◆ LAM4LD800-12-1Y	2	350 kcmil – 800 kcmil	1/2	1.75	3/8	6.19	6.53	1.88	.56	3.44	375	1

The use of PANDUIT oxide inhibiting joint compound (CMP-100) is recommended for pad to pad and conductor connections. See page D2.161.

*Listed torque values are for maximum conductor sizes, consult the installation instruction sheet for smaller sizes.

◆NEMA hole sizes and spacing.

F. Index

Transformer Lug Kit

For Use with Stranded Aluminum or Copper Code Conductors

Type KLM

- Kits include all of the connectors and hardware to make a complete transformer connection in a single convenient package
- Lugs are made from high strength, extruded aluminum alloy and are tin-plated to inhibit corrosion and oxidation
- Plated steel cap screws, belleville and flat washers, and hex nuts are provided to assure that terminal to bus connections are made using proper hardware resulting in true torque to pressure performance

- Hardware is packaged in a sealed plastic bag to prevent lost hardware prior to installation
- KLM6-800 and KLM350-800 kits include lugs that accommodate 750 kcmil conductors used with large transformers
- Lugs are UL Listed and CSA Certified for use up to 600 V and UL temperature rated 90°C



Part Number	Transformer KVA Rating	Aluminum Mechanical Lug		Conductor Size Range	Hardware (Sizes in Inches)					
		Part No.	Qty.		Hex Bolt Size	Qty.	Nut Size	Qty.	Washer Size	Qty.
KLM14-250Y	15 – 37.5 KVA 1PH 15 – 45 KVA 3PH	LAMA2-14	8	#14 – 2 AWG	1/4 – 20 x 3/4 HH	8	1/4 – 20 HN	8	1/4 FLAT 1/4 CMP	16 8
		LAMA250-56	4	#6 AWG – 250 kcmil						
KLM6-250Y	50 – 75 KVA 1 PH 75 – 112.5 KVA 3 PH	LAMA250-56	12	#6 AWG – 250 kcmil	1/4 – 20 x 3/4 HH 1/4 – 20 x 2 HH	8 8	1/4 – 20 HN	16	1/4 FLAT 1/4 CMP	32 16
KLM6-600Y	100 – 167 KVA 1PH 150 – 300 KVA 3 PH	LAMA250-56	3	#6 AWG – 250 kcmil	1/4 – 20 x 3/4 HH 3/8 – 16 x 2 HH	3 16	1/4 – 20 HN 3/8 – 16 HN	3 16	3/8 FLAT 1/4 FLAT 3/8 CMP 1/4 CMP	32 6 16 3
		LAMA600-38	3	#4 AWG – 600 kcmil						
KLM6-800Y	100 – 167 KVA 1 PH 150 – 300 KVA 3 PH	LAM2A350-12	6	#6 AWG – 350 kcmil	1/2 – 13 x 2 HH	5	1/2 – 13 HN	11	1/2 FLAT	22
		LAM2A800-58	7	350 kcmil – 800 kcmil	1/2 – 13 x 2 1/2 HH	6			1/2 CMP	11
KLM350-800Y	500 KVA 3 PH	LAM2A800-58	15	350 kcmil – 800 kcmil	1/2 – 13 x 2 HH 1/2 – 13 x 2 1/2 HH	7 4	1/2 – 13 HN	11	1/2 FLAT 1/2 CMP	22 11

Suffix: HH = Hex Head; HN = Hex Nut; FLAT = Flat Washer; CMP = Compression Washer.

The use of PANDUIT oxide inhibiting joint compound (CMP-100) is recommended for pad to pad and conductor connections. See page D2.161.

A.
System
Overview

B1.
Cable
Ties

B2.
Cable
Accessories

B3.
Stainless
Steel
Ties

C1.
Wiring
Duct

C2.
Surface
Raceway

C3.
Abrasion
Protection

C4.
Cable
Management

D1.
Terminals

D2.
Power
Connectors

D3.
Grounding
Connectors

E1.
Labeling
Systems

E2.
Labels

E3.
Pre-Printed
& Write-On
Markers

E4.
Permanent
Identification

E5.
Lockout/
Tagout/
& Safety
Solutions

F.
Index

A.
System
Overview



Splicer/Reducer

B1.
Cable Ties

For Use with Stranded Aluminum or Copper Code Conductors

Type SR

- Made from high strength extruded aluminum alloy to provide premium electrical and mechanical performance
- Tin-plated to inhibit corrosion
- Rounded bottoms to facilitate taping

- Solid center barrier prevents contact of dissimilar metal conductors
- Wide wire range-taking capability minimizes inventory requirements
- UL Listed and CSA Certified for use up to 600 V and UL temperature rated 90°C

B2.
Cable
Accessories

B3.
Stainless
Steel Ties

C1.
Wiring
Duct

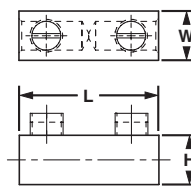

Figure 1

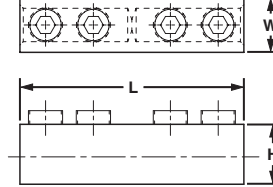

Figure 2

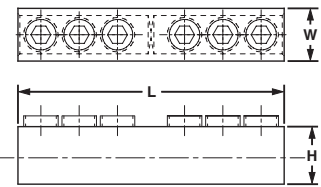

Figure 3

C2.
Surface
Raceway

C3.
Abrasion
Protection

C4.
Cable
Management

Part Number	Figure No.	Conductor Size Range		Figure Dimensions (In.)			Hex Key Size (In.)	Tightening Torque (In.-Lbs.)	Std. Pkg. Qty.
		Max.	Min.	L	W	H			
SR-2-XY	1	#2 AWG STR, #10 AWG SOL	#14 AWG STR, #14 AWG SOL	1.38	.50	.56	**	50*	10
SR-0-XY	1	1/0 AWG STR, #10 AWG SOL	#14 AWG STR, #14 AWG SOL	1.91	.75	.75	**	50*	10
SR-4/0-XY	1	4/0 AWG	#6 AWG	2.31	1.00	1.13	5/16	50	10
SR-250-XY	2	250 kcmil	#6 AWG	3.94	1.00	1.13	5/16	275	10
SR-350-XY	2	350 kcmil	#6 AWG	4.19	1.13	1.19	5/16	275	10
SR-500-3Y	2	500 kcmil	3/0 AWG	5.00	1.37	1.40	3/8	375	3
SR-750-1Y	2	750 kcmil	250 kcmil	6.25	1.63	1.75	1/2	500	1
SR-1000-1Y	3	1000 kcmil	500 kcmil	8.69	1.72	1.88	9/16	600	1

The use of PANDUIT oxide inhibiting joint compound (CMP-100) is recommended. See page D2.161.

*Listed torque values are for maximum conductor sizes, consult the installation instruction sheet for smaller sizes.

**Uses slotted screws.

D2.
Power
Connectors

D3.
Grounding
Connectors

E1.
Labeling
Systems

E2.
Labels

E3.
Pre-Printed
& Write-On
Markers

E4.
Permanent
Identification

E5.
Lockout/
Tagout/
& Safety
Solutions

F.
Index



Multi-Tap Connector with Clear Insulation, Single-Sided

For Use with Aluminum or Copper Code Conductors

Type PCSB-S

- Flexible design – can be used as a tap, splice, or dead end connector
- Body made from high strength, extruded aluminum alloy to provide premium electrical and mechanical performance
- Insulated with clear PVC to eliminate the need for taping and allow for visual inspection of the complete conductor insertion
- Each port pre-filled with oxide inhibiting joint compound seals out air and moisture to deter surface oxidation
- Wide wire range-taking capability minimizes inventory requirements
- Plated steel or aluminum set screw provides high strength, durable electrical contact between conductor and connector
- UL Listed and CSA Certified for use up to 600 V and temperature rated 90°C

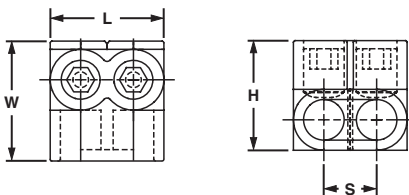

Part Number	Conductor Size Range	No. of Ports	Figure Dimensions (In.)				Hex Key Size (In.)	Tightening Torque (In.-Lbs.)	Std. Pkg. Qty.	
			L	W	H	S				
PCSB4-2S-12Y	#4 – 14 AWG STR	2	1.08	1.12	1.25	.44	1/8	50*	12	
PCSB4-3S-12Y		3	1.52	1.12	1.25	.44	1/8	50*	12	
PCSB4-4S-6Y		4	1.96	1.12	1.25	.44	1/8	50*	6	
PCSB4-5S-6Y		5	2.39	1.12	1.25	.44	1/8	50*	6	
PCSB4-6S-6Y		6	2.83	1.12	1.25	.44	1/8	50*	6	
PCSB4-10S-4Y		10	4.58	1.12	1.25	.44	1/8	50*	4	
PCSB4-12S-3Y		12	5.46	1.12	1.25	.44	1/8	50*	3	
PCSB4-14S-2Y		14	6.34	1.12	1.25	.44	1/8	50*	2	
PCSB2/0-2S-6		2/0 – 14 AWG STR	2	1.52	1.32	1.19	.67	3/16	120	6
PCSB2/0-3S-6Y			3	2.19	1.32	1.19	.67	3/16	120	6
PCSB2/0-4S-6Y	4		2.86	1.32	1.19	.67	3/16	120	6	
PCSB2/0-5S-4Y	5		3.53	1.32	1.19	.67	3/16	120	4	
PCSB2/0-6S-4Y	6		4.20	1.32	1.19	.67	3/16	120	4	
PCSB2/0-8S-3	8		5.55	1.32	1.19	.67	3/16	120	3	
PCSB2/0-10S-2Y	10		6.89	1.32	1.19	.67	3/16	120	2	
PCSB2/0-12S-1Y	12		8.24	1.32	1.19	.67	3/16	120	1	
PCSB2/0-14S-1Y	14		9.58	1.32	1.19	.67	3/16	120	1	
PCSB250-2S-6Y	250 kcmil – #10 AWG STR		2	2.03	2.07	2.13	.94	5/16	275	6
PCSB250-3S-6Y		3	2.97	2.07	2.13	.94	5/16	275	6	
PCSB250-4S-6Y		4	3.91	2.07	2.13	.94	5/16	275	6	
PCSB250-5S-4Y		5	4.84	2.07	2.13	.94	5/16	275	4	
PCSB250-6S-4Y		6	5.78	2.07	2.13	.94	5/16	275	4	
PCSB250-8S-3Y		8	7.66	2.07	2.13	.94	5/16	275	3	
PCSB250-10S-2Y		10	9.53	2.07	2.13	.94	5/16	275	2	
PCSB250-12S-2Y		12	11.41	2.07	2.13	.94	5/16	275	2	
PCSB250-14S-1Y		14	13.29	2.07	2.13	.94	5/16	275	1	
PCSB350-2S-4Y		350 kcmil – #10 AWG STR	2	2.17	2.32	2.50	1.00	5/16	275	4
PCSB350-3S-4Y	3		3.17	2.32	2.50	1.00	5/16	275	4	
PCSB350-4S-3Y	4		4.17	2.32	2.50	1.00	5/16	275	3	
PCSB350-5S-3Y	5		5.17	2.32	2.50	1.00	5/16	275	3	
PCSB350-6S-2Y	6		6.17	2.32	2.50	1.00	5/16	275	2	
PCSB350-8S-2Y	8		8.17	2.32	2.50	1.00	5/16	275	2	
PCSB350-10S-2Y	10		10.17	2.32	2.50	1.00	5/16	275	2	
PCSB350-12S-1Y	12		12.17	2.32	2.50	1.00	5/16	275	1	
PCSB350-14S-1Y	14		14.17	2.32	2.50	1.00	5/16	275	1	
PCSB600-2S-4Y	600 kcmil – #4 AWG STR		2	2.72	2.38	2.75	1.28	3/8	375	4
PCSB600-3S-3Y		3	4.00	2.38	2.75	1.28	3/8	375	3	
PCSB600-4S-2Y		4	5.28	2.38	2.75	1.28	3/8	375	2	
PCSB600-5S-2Y		5	6.56	2.38	2.75	1.28	3/8	375	2	
PCSB600-6S-2Y		6	7.84	2.38	2.75	1.28	3/8	375	2	
PCSB600-8S-2Y		8	10.41	2.38	2.75	1.28	3/8	375	2	
PCSB600-10S-1Y		10	12.97	2.38	2.75	1.28	3/8	375	1	
PCSB600-12S-1Y		12	15.93	2.38	2.75	1.28	3/8	375	1	
PCSB600-14S-1Y		14	18.09	2.38	2.75	1.28	3/8	375	1	

*Listed torque values are for maximum conductor sizes, consult the packaging label for smaller sizes.

A. System Overview

B1. Cable Ties

B2. Cable Accessories

B3. Stainless Steel Ties

C1. Wiring Duct

C2. Surface Raceway

C3. Abrasion Protection

C4. Cable Management

D1. Terminals

D2. Power Connectors

D3. Grounding Connectors

E1. Labeling Systems

E2. Labels

E3. Pre-Printed & Write-On Markers

E4. Permanent Identification

E5. Lockout/Tagout & Safety Solutions

F. Index

A. System Overview



Multi-Tap Connector with Clear Insulation, Double-Sided

For Use with Aluminum or Copper Code Conductors

B1. Cable Ties

Type PCSB

- Flexible design – can be used as a tap, splice, or dead end connector
- Body made from high strength, extruded aluminum alloy to provide premium electrical and mechanical performance
- Insulated with clear PVC to eliminate the need for taping and allow for visual inspection of the complete conductor insertion
- Each port pre-filled with oxide inhibiting joint compound seals out air and moisture to deter surface oxidation

- Wide wire range-taking capability minimizes inventory requirements
- Dual-sided entry allows offset and opposite entry for primary and secondary conductors
- Plated steel or aluminum set screw provides high strength, durable electrical contact between conductor and connector
- UL Listed and CSA Certified for use up to 600 V and temperature rated 90°C

B2. Cable Accessories

B3. Stainless Steel Ties

C1. Wiring Duct

C2. Surface Raceway

C3. Abrasion Protection

C4. Cable Management

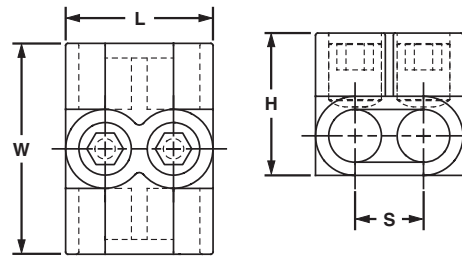

D1. Terminals

D2. Power Connectors

D3. Grounding Connectors

E1. Labeling Systems

E2. Labels

E3. Pre-Printed & Write-On Markers

E4. Permanent Identification

E5. Lockout/Tagout & Safety Solutions

F. Index

Part Number	Conductor Size Range	No. of Ports	Figure Dimensions (In.)				Hex Key Size (In.)	Tightening Torque (In.-Lbs.)	Std. Pkg. Qty.
			L	W	H	S			
PCSB4-2-12Y‡	#4 – 14 AWG STR #10 – 14 AWG SOL	2	1.16	1.50	1.25	.49	**	45*	12
PCSB4-3-12Y‡		3	1.64	1.50	1.25	.49	**	45*	12
PCSB4-4-6Y‡		4	2.13	1.50	1.25	.49	**	45*	6
PCSB4-5-6Y‡		5	2.62	1.50	1.25	.49	**	45*	6
PCSB4-6-6Y‡		6	3.10	1.50	1.25	.49	**	45*	6
PCSB4-7-4Y‡		7	3.59	1.50	1.25	.49	**	45*	4
PCSB4-8-4Y‡		8	4.08	1.50	1.25	.49	**	45*	4
PCSB4-10-4Y		#4 – 14 AWG STR #10 – 14 AWG SOL	10	4.58	1.50	1.25	.44	1/8	50*
PCSB4-12-3Y	12		5.46	1.50	1.25	.44	1/8	50*	3
PCSB4-14-2Y	14		6.34	1.50	1.25	.44	1/8	50*	2
PCSB2/0-2-12‡	2/0 – #14 AWG STR #10 – 14 AWG SOL	2	1.63	1.60	1.38	.72	3/16	50*	12
PCSB2/0-3-6‡		3	2.36	1.60	1.38	.72	3/16	50*	6
PCSB2/0-4-6‡		4	3.08	1.60	1.38	.72	3/16	50*	6
PCSB2/0-5-6‡		5	3.81	1.60	1.38	.72	3/16	50*	6
PCSB2/0-6-6‡		6	4.53	1.60	1.38	.72	3/16	50*	6
PCSB2/0-7-4‡		7	5.25	1.60	1.38	.72	3/16	50*	4
PCSB2/0-8-4‡		8	5.98	1.60	1.38	.72	3/16	50*	4
PCSB2/0-10-2Y		2/0 – #14 AWG STR	10	6.89	1.56	1.38	.67	3/16	120
PCSB2/0-12-2Y	12		8.24	1.56	1.38	.67	3/16	120	2
PCSB2/0-14-1Y	14		9.58	1.56	1.38	.67	3/16	120	1
PCSB250-2-6Y‡	250 kcmil – #6 AWG STR	2	2.13	2.60	2.13	.97	5/16	275	6
PCSB250-3-6Y‡		3	3.10	2.60	2.13	.97	5/16	275	6
PCSB250-4-6Y‡		4	4.06	2.60	2.13	.97	5/16	275	6
PCSB250-5-4Y‡		5	5.03	2.60	2.13	.97	5/16	275	4
PCSB250-6-4Y‡		6	6.00	2.60	2.13	.97	5/16	275	4
PCSB250-7-3Y‡		7	6.98	2.60	2.13	.97	5/16	275	3
PCSB250-8-3Y‡		8	7.95	2.60	2.13	.97	5/16	275	3
PCSB250-10-2Y		250 kcmil – #10 AWG STR	10	9.53	2.64	2.13	.94	5/16	275
PCSB250-12-2Y	12		11.41	2.64	2.13	.94	5/16	275	2
PCSB250-14-1Y	14		13.29	2.64	2.13	.94	5/16	275	1

*Listed torque values are for maximum conductor sizes, consult the packaging label for smaller sizes.
 **Uses slotted head set screw.
 ‡Not CSA Certified.
 ‡‡Not UL Listed or CSA Certified.



Multi-Tap Connector with Clear Insulation, Double-Sided (continued)

Part Number	Conductor Size Range	No. of Ports	Figure Dimensions (In.)				Hex Key Size (In.)	Tightening Torque (In.-Lbs.)	Std. Pkg. Qty.	
			L	W	H	S				
PCSB350-2-4‡	350 kcmil – #10 AWG STR #10 AWG SOL	2	2.22	3.00	2.50	1.02	3/8	375	4	
PCSB350-3-4‡		3	3.24	3.00	2.50	1.02	3/8	375	4	
PCSB350-4-3‡		4	4.25	3.00	2.50	1.02	3/8	375	3	
PCSB350-5-3‡		5	5.28	3.00	2.50	1.02	3/8	375	3	
PCSB350-6-2‡		6	6.30	3.00	2.50	1.02	3/8	375	2	
PCSB350-7-2‡		7	7.31	3.00	2.50	1.02	3/8	375	2	
PCSB350-8-2‡		8	8.33	3.00	2.50	1.02	3/8	375	2	
PCSB350-10-2Y		10	10.17	3.00	2.50	1.00	5/16	275	2	
PCSB350-12-1Y	350 kcmil – #10 AWG STR	12	12.17	3.00	2.50	1.00	5/16	275	1	
PCSB350-14-1Y		14	14.17	3.00	2.50	1.00	5/16	275	1	
PCSB500-2-4Y‡		2	2.71	3.00	2.75	1.27	3/8	375	4	
PCSB500-3-3Y‡	500 kcmil – #6 AWG STR	3	4.00	3.00	2.75	1.27	3/8	375	3	
PCSB500-4-2Y‡		4	5.26	3.00	2.75	1.27	3/8	375	2	
PCSB500-5-2Y‡		5	6.53	3.00	2.75	1.27	3/8	375	2	
PCSB500-6-2Y‡		6	7.81	3.00	2.75	1.27	3/8	375	2	
PCSB500-7-2Y‡		7	9.08	3.00	2.75	1.27	3/8	375	2	
PCSB500-8-2Y‡		8	10.35	3.00	2.75	1.27	3/8	375	2	
PCSB600-2-4Y		600 kcmil – #4 AWG STR	2	2.72	3.00	2.75	1.28	3/8	375	4
PCSB600-3-3Y			3	4.00	3.00	2.75	1.28	3/8	375	3
PCSB600-4-2Y	4		5.28	3.00	2.75	1.28	3/8	375	2	
PCSB600-5-2	5		6.56	3.00	2.75	1.28	3/8	375	2	
PCSB600-6-2Y	6		7.84	3.00	2.75	1.28	3/8	375	2	
PCSB600-8-2Y	8		10.41	3.00	2.75	1.28	3/8	375	2	
PCSB600-10-1Y	10		12.97	3.00	2.75	1.28	3/8	375	1	
PCSB600-12-1Y	12		15.53	3.00	2.75	1.28	3/8	375	1	
PCSB600-14-1Y	14		18.09	3.00	2.75	1.28	3/8	375	1	
PCSB750-2-2Y‡‡	750 kcmil – 1/0 AWG STR		2	3.00	3.38	2.25	1.41	3/8	375	2
PCSB750-3-2Y‡‡		3	4.44	3.38	2.25	1.41	3/8	375	2	
PCSB750-4-2Y‡‡		4	5.81	3.38	2.25	1.41	3/8	375	2	
PCSB750-5-1Y‡‡		5	7.25	3.38	2.25	1.41	3/8	375	1	
PCSB750-6-1Y‡‡		6	8.63	3.38	2.25	1.41	3/8	375	1	
PCSB750-7-1Y‡‡		7	10.00	3.38	2.25	1.41	3/8	375	1	
PCSB750-8-1Y‡‡		8	11.44	3.38	2.25	1.41	3/8	375	1	
PCSB750-9-1Y‡‡		9	12.81	3.38	2.25	1.41	3/8	375	1	
PCSB750-10-1Y‡‡		10	14.25	3.38	2.25	1.41	3/8	375	1	

‡Not CSA Certified.

‡‡Not UL Listed or CSA Certified.

A.
System
Overview

B1.
Cable Ties

B2.
Cable
Accessories

B3.
Stainless
Steel Ties

C1.
Wiring
Duct

C2.
Surface
Raceway

C3.
Abrasion
Protection

C4.
Cable
Management

D1.
Terminals

D2.
Power
Connectors

D3.
Grounding
Connectors

E1.
Labeling
Systems

E2.
Labels

E3.
Pre-Printed
& Write-On
Markers

E4.
Permanent
Identification

E5.
Lockout/
Tagout
& Safety
Solutions

F.
Index

A.
System
Overview



In-Line Splicer/Reducer with Clear Insulation

B1.
Cable Ties

For Use with Aluminum or Copper Code Conductors

Type PISR

- Flexible design – can be used as a splice or reducer
- Dual rated for use with copper or aluminum conductors
- Made from high strength, extruded aluminum alloy to provide premium electrical and mechanical performance
- Insulated with clear PVC to eliminate the need for taping and allow for visual inspection of the complete conductor insertion
- Each port pre-filled with oxide inhibiting joint compound seals out air and moisture to deter surface oxidation
- Wide wire range-taking capability minimizes inventory requirements
- Plated steel or aluminum set screw provides high strength, durable electrical contact between conductor and connector
- UL Listed and CSA Certified for use up to 600 V and UL temperature rated 90°C

B2.
Cable
Accessories

B3.
Stainless
Steel Ties

C1.
Wiring
Duct

C2.
Surface
Raceway

C3.
Abrasion
Protection

C4.
Cable
Management

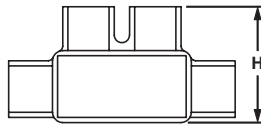
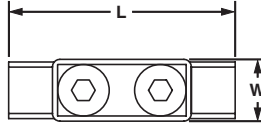

D1.
Terminals

D2.
Power
Connectors

D3.
Grounding
Connectors

E1.
Labeling
Systems

E2.
Labels

E3.
Pre-Printed
& Write-On
Markers

E4.
Permanent
Identification

E5.
Lockout/
Tagout/
& Safety
Solutions

F.
Index

Part Number	Conductor Size Range	Figure Dimensions (In.)			Std. Pkg. Qty.
		L	W	H	
PISR2-1	#2 AWG STR – #14 AWG SOL	2.38	.75	1.25	1
PISR1/0-1	1/0 AWG STR – #14 AWG SOL	2.91	.95	1.41	1
PISR250-1	250 kcmil – #10 AWG SOL	4.00	1.25	2.24	1
PISR350-1	350 kcmil – #10 AWG SOL	4.63	1.40	2.28	1
PISR500-1	500 kcmil – #6 AWG SOL	5.25	1.72	2.56	1



Multi-Tap Connector with Clear Insulation, Single-Sided, with Mounting Holes

For Use with Aluminum or Copper Code Conductors

Type PCSBMT-S

- Flexible design – can be used as a tap, splice, or dead end connector
- Body made from high strength, extruded aluminum alloy to provide premium electrical and mechanical performance
- Two isolated mounting holes at either end of connector facilitate direct mounting using 1/4" bolts
- Insulated with clear PVC to eliminate the need for taping and allow for visual inspection of the complete conductor insertion



- Each port pre-filled with oxide inhibiting joint compound seals out air and moisture to deter surface oxidation
- Wide wire range-taking capability minimizes inventory requirements
- Plated steel or aluminum set screw provides high strength, durable electrical contact between conductor and connector
- UL Listed and CSA Certified for use up to 600 V and temperature rated 90°C

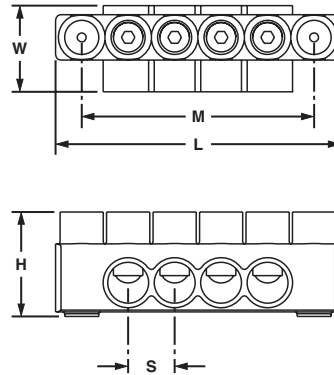

Part Number	Conductor Size Range	No. of Ports	Figure Dimensions (In.)					Mounting Hole Size (In.)	Hex Key Size (In.)	Tightening Torque (In.-Lbs.)	Std. Pkg. Qty.
			L	W	H	S	M				
PCSBMT2/0-4S-3Y	2/0 – #14 AWG STR	4	4.20	1.38	1.50	.67	3.00	1/4	3/16	120	3
PCSBMT2/0-6S-2Y		6	5.55	1.38	1.50	.67	4.70	1/4	3/16	120	2
PCSBMT2/0-8S-2Y		8	6.89	1.38	1.50	.67	6.05	1/4	3/16	120	2
PCSBMT2/0-10S2Y		10	8.24	1.38	1.50	.67	7.39	1/4	3/16	120	2
PCSBMT2/0-12S1Y		12	9.58	1.38	1.50	.67	8.74	1/4	3/16	120	1
PCSBMT250-4S-2Y	250 kcmil – #10 AWG STR	4	5.78	2.07	2.26	.94	4.69	1/4	5/16	275	2
PCSBMT250-6S-2Y		6	7.66	2.07	2.26	.94	6.57	1/4	5/16	275	2
PCSBMT250-8S-2Y		8	9.53	2.07	2.26	.94	8.44	1/4	5/16	275	2
PCSBMT250-10S2Y		10	11.41	2.07	2.26	.94	10.32	1/4	5/16	275	2
PCSBMT250-12S1Y		12	13.29	2.07	2.26	.94	12.19	1/4	5/16	275	1
PCSBMT350-4S-2Y	350 kcmil – #10 AWG STR	4	6.17	2.32	2.63	1.00	5.00	1/4	5/16	275	2
PCSBMT350-6S-2Y		6	8.17	2.32	2.63	1.00	7.00	1/4	5/16	275	2
PCSBMT350-8S-2Y		8	10.17	2.32	2.63	1.00	9.00	1/4	5/16	275	2
PCSBMT350-10S1Y		10	12.17	2.32	2.63	1.00	11.00	1/4	5/16	275	1
PCSBMT350-12S1Y		12	14.17	2.32	2.63	1.00	13.00	1/4	5/16	275	1
PCSBMT600-4S-2Y	600 kcmil – #4 AWG STR	4	7.84	2.38	2.88	1.28	6.41	1/4	3/8	375	2
PCSBMT600-6S-2Y		6	10.41	2.38	2.88	1.28	8.97	1/4	3/8	375	2
PCSBMT600-8S-2Y		8	12.97	2.38	2.88	1.28	11.53	1/4	3/8	375	2
PCSBMT600-10S1Y		10	15.53	2.38	2.88	1.28	14.09	1/4	3/8	375	1
PCSBMT600-12S1Y		12	18.09	2.38	2.88	1.28	16.65	1/4	3/8	375	1

A. System Overview

B1. Cable Ties

B2. Cable Accessories

B3. Stainless Steel Ties

C1. Wiring Duct

C2. Surface Raceway

C3. Abrasion Protection

C4. Cable Management

D1. Terminals

D2. Power Connectors

D3. Grounding Connectors

E1. Labeling Systems

E2. Labels

E3. Pre-Printed & Write-On Markers

E4. Permanent Identification

E5. Lockout/Tagout & Safety Solutions

F. Index

A.
System
Overview



Multi-Tap Connector with Clear Insulation, Double-Sided, with Mounting Holes

For Use with Aluminum or Copper Code Conductors

B1.
Cable Ties

Type PCSBMT

- Flexible design – can be used as a tap, splice, or dead end connector
- Body made from high strength, extruded aluminum alloy to provide premium electrical and mechanical performance
- Two isolated mounting holes at either end of connector facilitate direct mounting using 1/4" bolts
- Insulated with clear PVC to eliminate the need for taping and allow for visual inspection of the complete conductor insertion

- Each port pre-filled with oxide inhibiting joint compound seals out air and moisture to deter surface oxidation
- Wide wire range-taking capability minimizes inventory requirements
- Dual-sided entry allows offset and opposite entry for primary and secondary conductors
- Plated steel or aluminum set screw provides high strength, durable electrical contact between conductor and connector
- UL Listed and CSA Certified for use up to 600 V and temperature rated 90°C

B2.
Cable
Accessories

B3.
Stainless
Steel Ties

C1.
Wiring
Duct

C2.
Surface
Raceway

C3.
Abrasion
Protection

C4.
Cable
Management

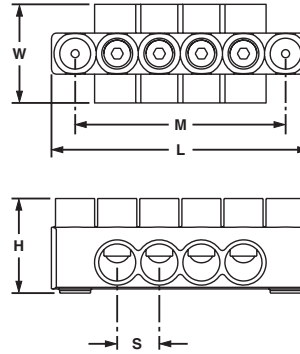

D1.
Terminals

D2.
Power
Connectors

D3.
Grounding
Connectors

E1.
Labeling
Systems

E2.
Labels

E3.
Pre-Printed
& Write-On
Markers

E4.
Permanent
Identification

E5.
Lockout/
Tagout/
& Safety
Solutions

F.
Index

Part Number	Conductor Size Range	No. of Ports	Figure Dimensions (In.)					Mounting Hole Size (In.)	Hex Key Size (In.)	Tightening Torque (In.-Lbs.)	Std. Pkg. Qty.
			L	W	H	S	M				
PCSBMT2/0-4-3Y	2/0 – #14 AWG STR	4	4.20	1.56	1.50	.67	3.00	1/4	3/16	120	3
PCSBMT2/0-6-2Y		6	5.55	1.56	1.50	.67	4.70	1/4	3/16	120	2
PCSBMT2/0-8-2Y		8	6.89	1.56	1.50	.67	6.05	1/4	3/16	120	2
PCSBMT2/0-10-2Y		10	8.24	1.56	1.50	.67	7.39	1/4	3/16	120	2
PCSBMT2/0-12-1Y	250 kcmil – #10 AWG STR	12	9.58	1.56	1.50	.67	8.74	1/4	3/16	120	1
PCSBMT250-4-2Y		4	5.78	2.64	2.26	.94	4.69	1/4	5/16	275	2
PCSBMT250-6-2Y		6	7.66	2.64	2.26	.94	6.57	1/4	5/16	275	2
PCSBMT250-8-2Y		8	9.53	2.64	2.26	.94	8.44	1/4	5/16	275	2
PCSBMT250-10-2Y	350 kcmil – #10 AWG STR	10	11.41	2.64	2.26	.94	10.32	1/4	5/16	275	2
PCSBMT250-12-1Y		12	13.29	2.64	2.26	.94	12.19	1/4	5/16	275	1
PCSBMT350-4-2Y		4	6.17	3.00	2.63	1.00	5.00	1/4	5/16	275	2
PCSBMT350-6-2Y		6	8.17	3.00	2.63	1.00	7.00	1/4	5/16	275	2
PCSBMT350-8-2Y	600 kcmil – #4 AWG STR	8	10.17	3.00	2.63	1.00	9.00	1/4	5/16	275	2
PCSBMT350-10-1Y		10	12.17	3.00	2.63	1.00	11.00	1/4	5/16	275	1
PCSBMT350-12-1Y		12	14.17	3.00	2.63	1.00	13.00	1/4	5/16	275	1
PCSBMT600-4-2Y		4	7.84	3.00	2.88	1.28	6.41	1/4	3/8	375	2
PCSBMT600-6-2Y	600 kcmil – #4 AWG STR	6	10.41	3.00	2.88	1.28	8.97	1/4	3/8	375	2
PCSBMT600-8-2Y		8	12.97	3.00	2.88	1.28	11.53	1/4	3/8	375	2
PCSBMT600-10-1Y		10	15.53	3.00	2.88	1.28	14.09	1/4	3/8	375	1
PCSBMT600-12-1Y		12	18.09	3.00	2.88	1.28	16.65	1/4	3/8	375	1

Belleville Compression Washers

Type CW

- Conical spring washer for use when assembling aluminum connectors to copper and/or steel pads, compensates for differing rates of thermal expansion to keep hardware assembly from loosening

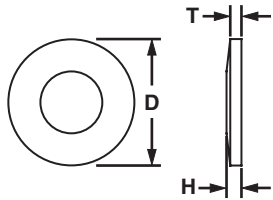

- For assembly information, see page D2.162
- Made from hardened steel to provide high strength
- Cadmium-plated to inhibit corrosion

Part Number	Stud Hole Size (In.)	Figure Dimensions (In.)			Std. Pkg. Qty.
		D	H	T	
CW-14-L	1/4	.68	.09	.05	50
CW-56-L	5/16	.81	.08	.06	50
CW-38-L	3/8	.93	.10	.07	50
CW-12-Q	1/2	1.18	.12	.09	25
CW-58-Q	5/8	1.49	.15	.12	25

Joint Compounds

For Use with Aluminum Connectors

Type CMP

- Oxide inhibitor for compression conductor connections lowers electrical resistance of compression joint while sealing out air and moisture to prevent the formation of surface oxides



- Wide operating temperature range; can be used in a wide range of electrical and environmental conditions
- Packaged in convenient dispenser bottles

Part Number	Description	Std. Pkg. Qty.
CMP-100-1	Contact aid for pad-to-pad or thread-to-thread aluminum connections, 8 oz. Operating temperature range -60°F (-51°C) to 400°F (204°C).	1

A.
System
Overview

B1.
Cable Ties

B2.
Cable
Accessories

B3.
Stainless
Steel Ties

C1.
Wiring
Duct

C2.
Surface
Raceway

C3.
Abrasion
Protection

C4.
Cable
Management

D1.
Terminals

D2.
Power
Connectors

D3.
Grounding
Connectors

E1.
Labeling
Systems

E2.
Labels

E3.
Pre-Printed
& Write-On
Markers

E4.
Permanent
Identification

E5.
Lockout/
Tagout/
& Safety
Solutions

F.
Index

A.
System
Overview

Guidelines for Installing Aluminum Mechanical Connectors

B1.
Cable Ties



1. Select the correct connector for your application.

- Always use an aluminum conductor with an aluminum connector
- Verify that the connector is marked for the conductor size and type that you are using

B2.
Cable
Accessories

B3.
Stainless
Steel Ties

C1.
Wiring
Duct



2. Remove the insulation from insulated cable.

- See page D3.34 for *PANDUIT* cable stripping tools
- Use care to avoid nicking the conductor strands
- Strip the insulation to the proper length as listed in the installation instructions provided with *PANDUIT* connectors

C2.
Surface
Raceway

C3.
Abrasion
Protection

C4.
Cable
Management



3. Clean the exposed conductor using a wire brush or an emery cloth.

- In a similar manner, clean an unplated connector pad and the surface to which the connector will be attached
- Solvent should be used to clean plated parts that are dirty, but the plating should never be disturbed with abrasives

D1.
Terminals

D2.
Power
Connectors

D3.
Grounding
Connectors



4. Apply *PANDUIT* joint compound to the clean conductor for mechanical connector applications (see pages D2.161).

- Joint compound will deter the formation of surface oxides after installation
- Aluminum compression connectors and insulated mechanical connectors are pre-filled with joint compound

E1.
Labeling
Systems

E2.
Labels

E3.
Pre-Printed
& Write-On
Markers



5. Insert the conductor into the connector and:

- For mechanical connectors, tighten the screws to the recommended torque values
- For compression connectors, use the recommended die and crimping tool to make the proper compression connection

E4.
Permanent
Identification

E5.
Lockout/
Tagout/
& Safety
Solutions

F.
Index

PANDUIT Power Connector Approvals



Logo (Symbol)	Agency	Spec/Approval	Applicable Products
	Underwriters Laboratories, Inc.	UL 486A Wire Connectors and Soldering Lugs for use in US and Canada	LCAX, LCBX, LCCX, LCDX, LCAN, LCDN, RSC, LCEX
	Underwriters Laboratories, Inc.	UL 486A Wire Connectors and Soldering Lugs for use in US	Copper and aluminum compression connectors (except: SCT, HTAP, TAPC, SAR); Copper and aluminum split bolts; Copper and aluminum mechanical lugs and splices (except: PNLC, LAM2A1000, LAM3B, LAM3SB, LAM3D, LAM4D, PCSB750, LAM2LB800)
	Underwriters Laboratories, Inc.	UL 486A Wire Connectors and Soldering Lugs for use in US	LCA-00, LCD-00, LCC-00, LCMA6, LCMA16, LCMA-00, LCMD6, LCD16, LCMD-00, SCMS16
	Canadian Standards Association	C22.2 No. 65-03 Wire Connectors	Copper and aluminum compression connectors (except: SCT, HTAP, TAPC, SAR, CTAP, BPC); Copper and aluminum split bolts (except: SBCL, VT, VTA); Copper and aluminum mechanical lugs and splices (except: PNLC, LAM2A1000, LAM3B, LAM3SB, LAM3D, LAM4D, PCSB750, ML, ML-T, HL, HLB, HLA-90, PNL-2, HL-2, HL-2N, HHL-2N, H2L-2N, P2NLT, PNLC, HC, LAM2A1000, LAM2B, LAM2SB600, LAM2SB750, LAM3B, LAM3SB, LAM3D, LAM4D, PCSB750)
	American Bureau of Shipping	ABS Rules Steel Vessel Rules 1-1-4/7.7, 4-8-3/9.19, 4-8-4/21.27	Copper compression connectors LCA, LCAF, LCAS, LCAX, LCB, LCC, LCD, S-R, LCDX, SCS, SCSF
NEBS Level 3	Telcordia Technologies, Inc.	Network Equipment – Building Systems	Copper compression connectors LCAS, LCA, LCD, LCB, LCC, LCAF, LCCF, SCSS, SCS, SCL, SCSF

A.
System
Overview

B1.
Cable Ties

B2.
Cable
Accessories

B3.
Stainless
Steel Ties

C1.
Wiring
Duct

C2.
Surface
Raceway

C3.
Abrasion
Protection

C4.
Cable
Management

D1.
Terminals

D2.
Power
Connectors

D3.
Grounding
Connectors

E1.
Labeling
Systems

E2.
Labels

E3.
Pre-Printed
& Write-On
Markers

E4.
Permanent
Identification

E5.
Lockout/
Tagout
& Safety
Solutions

F.
Index

A. System Overview

Recommended Termination Hardware

B1. Cable Ties

B2. Cable Accessories

B3. Stainless Steel Ties

C1. Wiring Duct

C2. Surface Raceway

C3. Abrasion Protection

C4. Cable Management

D1. Terminals

D2. Power Connectors

D3. Grounding Connectors

E1. Labeling Systems

E2. Labels

E3. Pre-Printed & Write-On Markers

E4. Permanent Identification

E5. Lockout/Tagout & Safety Solutions

F. Index

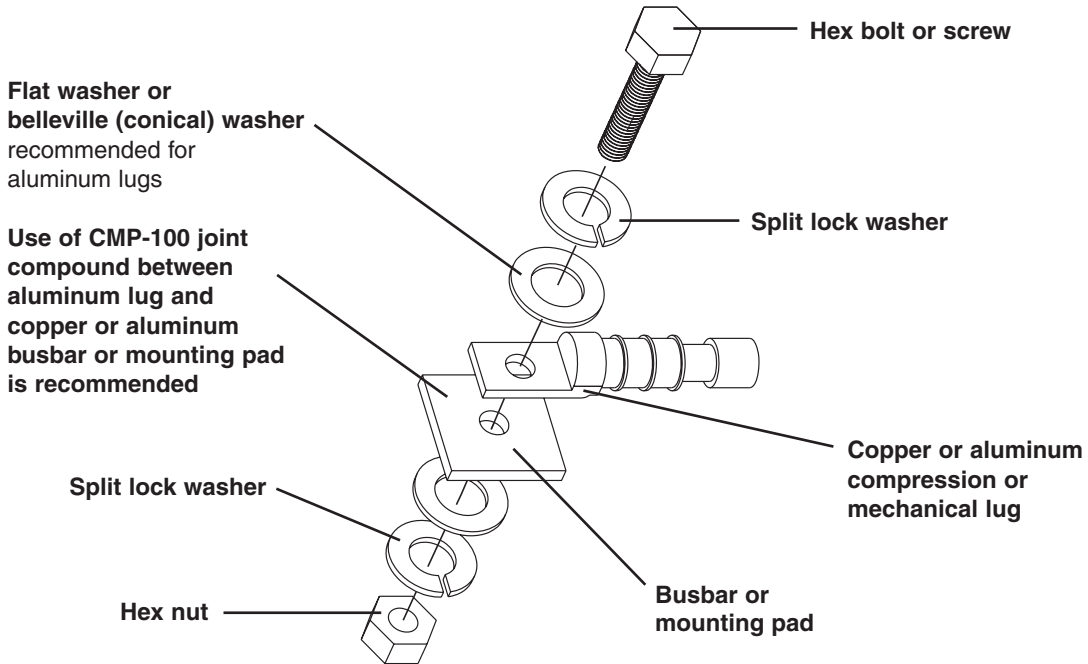
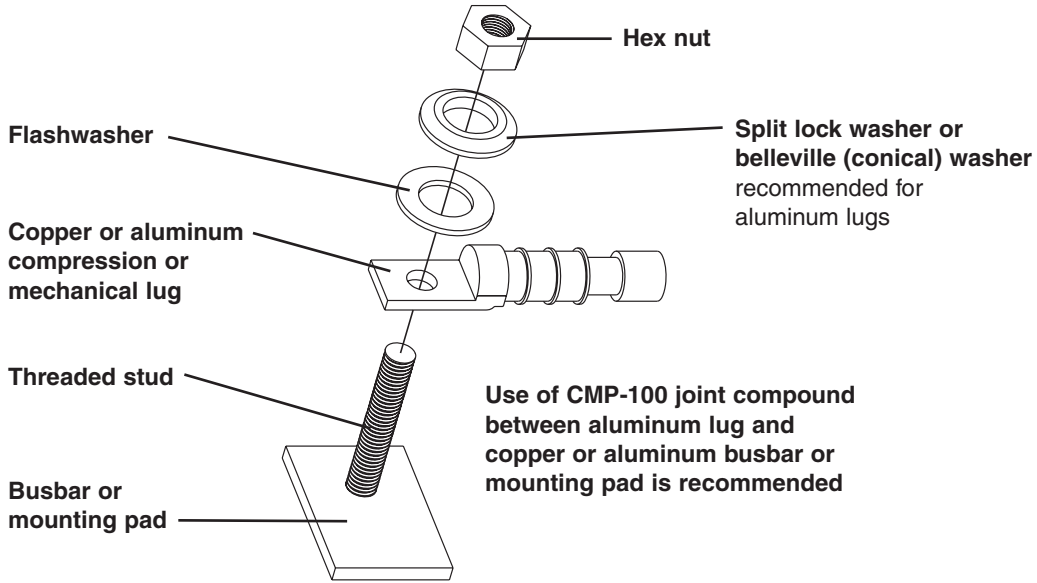

Recommended Hardware Material

Material Configuration of Lug/Mounting Surface

Copper to Copper	Aluminum to Copper	Aluminum to Aluminum	Copper to Steel	Aluminum to Steel
<ol style="list-style-type: none"> 1. Silicon bronze 2. Stainless steel 	<ol style="list-style-type: none"> 1. Silicon bronze 2. Aluminum 3. Stainless steel 	<ol style="list-style-type: none"> 1. Aluminum 2. Stainless steel 3. Plated silicon bronze 	<ol style="list-style-type: none"> 1. Silicon bronze 2. Stainless steel 	<ol style="list-style-type: none"> 1. Aluminum 2. Stainless steel

Conductor Sizes

Copper Concentric Stranded Conductor Sizes

Conductor Size AWG or kcmil	Number of Strands	Nominal Diameter (In.)	Class
#20	7	.036 /3	B
#18	7	.045 /6	B
#16	7	.057 /6	B
#14	7	.072 /6	B
#12	7	.091 /5	B
#10	7	.116	B
#9	7	.130	B
#8	7	.146	B
#7	7	.164	B
#6	7	.184	B
#5	7	.206	B
#4	3	.254	AA
#4	7	.232	B&A
#3	3	.285	AA
#3	7	.260	B&A
#2	3	.320	AA
#2	7	.292	B&A
#1	3	.360	AA
#1	7	.328	AA
#1	19	.332	B
1/0	7	.368	A&A
1/0	12	.390	—
1/0	19	.373	B
2/0	7	.414	A&A
2/0	12	.438	—
2/0	19	.419	B
3/0	7	.464	A&A
3/0	12	.492	—
3/0	19	.470	B
4/0	7	.522	A&A
4/0	12	.522	—
4/0	19	.528	B
250	12	.600	AA
250	19	.574	A
250	37	.575	B
300	12	.657	AA
300	19	.628	A
300	37	.630	B
350	12	.710	AA
350	19	.679	A
350	37	.681	B
400	19	.726	A&AA
400	37	.728	B
450	19	.770	AA
450	37	.772	B&A
500	19	.811	AA
500	37	.813	B&A
600	37	.891	A&AA
600	61	.893	B
700	37	.963	BB
700	61	.964	B&A
750	37	.977	AA
750	61	.998	B&A
800	37	1.029	AA
800	61	1.031	B&A
900	37	1.092	AA
900	61	1.094	B&A
1000	37	1.151	AA
1000	61	1.152	B&A
1000	61	1.152	B&A

Flexible Copper Conductor Sizes

Conductor Size AWG or kcmil	Number of Strands	Nominal Diameter (In.)	Class
#8	41/.0201	.156	I
#8	49/.0184	.166	G
#8	133/.0111	.167	H
#8	168/.010	.157	K
#8	37	.330	Locomotive (DLO)
#8	420/.0063	.162	M
#7	49/.0206	.185	G
#7	52/.0201	.185	I
#7	133/.0125	.188	H
#7	210/.010	.179	K
#7	—	—	Locomotive (DLO)
#7	532/.0063	.196	M
#6	49/.0231	.208	G
#6	63/.0201	.207	I
#6	133/.0140	.210	H
#6	266/.010	.210	K
#6	61	.410	Locomotive (DLO)
#6	665/.0063	.215	M
#5	49/.0260	.234	G
#5	84/.0201	.235	I
#5	133/.0158	.237	H
#5	336/.010	.235	K
#5	—	—	Locomotive (DLO)
#5	836/.0063	.240	M
#4	49/.0292	.263	G
#4	105/.0201	.263	I
#4	133/.0177	.266	H
#4	420/.010	.272	K
#4	105	.460	Locomotive (DLO)
#4	1064/.0063	.269	M
#3	49/.0328	.295	G
#3	133/.0199	.299	H
#3	133/.0201	.291	I
#3	532/.010	.304	K
#3	125	.480	Locomotive (DLO)
#3	1323/.0063	.305	M
#2	49/.0368	.331	G
#2	133/.0223	.335	H
#2	161/.0201	.319	I
#2	665/.010	.338	K
#2	150	.510	Locomotive (DLO)
#2	1666/.0063	.337	M
#1	133/.0251	.337	G
#1	210/.0201	.367	I
#1	259/.018	.378	H
#1	836/.010	.397	K
#1	225	.650	Locomotive (DLO)
#1	2107/.0063	.376	M
1/0	133/.0282	.423	G
1/0	259/.0202	.424	H
1/0	266/.0201	.441	I
1/0	1064/.010	.451	K
1/0	275	.680	Locomotive (DLO)
1/0	2646/.0063	.423	M
2/0	133/.0316	.474	G
2/0	259/.0227	.477	H
2/0	342/.0201	.500	I
2/0	1323/.010	.470	K
2/0	325	.720	Locomotive (DLO)
2/0	3325/.0063	.508	M

Table continues on page D2.166

A.
System
Overview

B1.
Cable
Ties

B2.
Cable
Accessories

B3.
Stainless
Steel Ties

C1.
Wiring
Duct

C2.
Surface
Raceway

C3.
Abrasion
Protection

C4.
Cable
Management

D1.
Terminals

D2.
Power
Connectors

D3.
Grounding
Connectors

E1.
Labeling
Systems

E2.
Labels

E3.
Pre-Printed
& Write-On
Markers

E4.
Permanent
Identification

E5.
Lockout/
Tagout
& Safety
Solutions

F.
Index

A.
System
Overview

Conductor Sizes (continued)

B1.
Cable Ties

Flexible Copper Conductor Sizes

Conductor Size AWG or kcmil	No. of Strands/ Strand Dia.	Nominal Diameter (In.)	Class
3/0	133/.0355	.533	G
3/0	259/.0255	.536	H
3/0	418/.0201	.549	I
3/0	1666/.010	.533	K
3/0	450	.810	Locomotive (DLO)
3/0	4256/.0063	.576	M
4/0	133/.0399	.599	G
4/0	259/.0286	.601	H
4/0	532/.0201	.613	I
4/0	2107/.010	.627	K
4/0	550	.840	Locomotive (DLO)
4/0	5320/.0063	.645	M
250	259/.0311	.650	G
250	427/.0242	.653	H
250	637/.0201	.682	I
250	2499/.010	.682	K
262.6	650	.960	Locomotive (DLO)
250	6384/.0063	.713	M
300	259/.0340	.714	G
300	427/.0265	.716	H
300	735/.0201	.737	I
300	2989/.010	.768	K
313.1	775	1.040	Locomotive (DLO)
300	7581/.0063	.768	M
350	259/.0368	.773	G
350	427/.0268	.772	H
350	882/.0201	.800	I
350	3458/.010	.809	K
373.7	925	1.140	Locomotive (DLO)
350	8806/.0063	.825	M
400	259/.0393	.825	G
400	427/.0306	.826	H
400	980/.0201	.831	I
400	3990/.010	.878	K
400	—	—	Locomotive (DLO)
400	10101/.0063	.901	M
450	259/.0417	.876	G
450	427/.325	.878	H
450	1127/.0201	.894	I
450	4522/.010	.933	K
444.4	1100	1.230	Locomotive (DLO)
450	11396/.0063	.940	M
500	259/.0439	.922	G
500	427/.0342	.923	H
500	1125/.0201	.941	I
500	5054/.010	.988	K
535.3	1325	1.320	Locomotive (DLO)
500	12691/.0063	.997	M
600	427/.0375	1.013	G
600	703/.0292	1.022	H
600	1470/.0201	1.027	I
600	5985/.010	1.125	K
646.4	1600	1.450	Locomotive (DLO)
600	14945/.0063	1.084	M
700	427/.0405	1.094	G
700	703/.0316	1.106	H
700	1729/.0201	1.194	I
700	6916/.010	1.207	K
777.7	1925	1.540	Locomotive (DLO)
700	17507/.0063	1.183	M

Flexible Copper Conductor Sizes

Conductor Size AWG or kcmil	No. of Strands/ Strand Dia.	Nominal Diameter (In.)	Class
800	427/.0433	1.169	G
800	703/.0337	1.180	H
800	1995/.0201	1.290	I
800	7980/.010	1.305	K
800	—	—	Locomotive (DLO)
800	20069/.0063	1.256	M
900	427/.0459	1.239	G
900	703/.0358	1.253	H
900	2261/.0201	1.372	I
900	9065/.010	1.323	K
900	—	—	Locomotive (DLO)
900	22631/.0063	1.331	M
1000	427/.0484	1.307	G
1000	703/.0377	1.320	H
1000	2527/.0201	1.427	I
1000	10101/.010	1.419	K
1000	—	—	Locomotive (DLO)
1000	25193/.0063	1.404	M

Copper Compact Stranded Conductor Sizes

Conductor Size AWG or kcmil	Number of Strands	Conductor Diameter (In.)	Class
#8	7	.134	Compact
#6	7	.169	Compact
#4	7	.213	Compact
#2	7	.268	Compact
#1	19	.299	Compact
1/0	19	.336	Compact
1/0	19	.376	Compact
3/0	19	.423	Compact
4/0	19	.475	Compact
250	37	.520	Compact
300	37	.570	Compact
350	37	.616	Compact
400	37	.659	Compact
450	37	.700	Compact
500	37	.736	Compact
550	61	.775	Compact
600	61	.813	Compact
650	61	.845	Compact
700	61	.877	Compact
750	61	.908	Compact
800	61	.938	Compact
900	61	.999	Compact
1000	61	1.060	Compact

F.
Index

Conductor Sizes (continued)

Copper Solid Conductor Sizes

Solid Copper Conductor Size AWG or kcmil	Conductor Diameter (In.)
#18	.040
#17	.045
#16	.050
#15	.057
#14	.064
#13	.071
#12	.080
#11	.090
#10	.101
#9	.114
#8	.128
#7	.128
#6	.162
#5	.181
#4	.204
#3	.229
#2	.257
#1	.289
1/0	.324
2/0	.364
3/0	.409
4/0	.460

Aluminum Concentric Stranded Conductor Sizes

Class B Aluminum Concentric AWG or kcmil	Number of Strands	Diameter of each Strand (Mils)
#8	7	48.6
#7	7	54.5
#6	7	61.2
#5	7	68.8
#4	7	77.2
#3	7	86.7
#2	7	97.4
#1	19	66.4
1/0	19	74.5
2/0	19	83.7
3/0	19	94.0
4/0	19	105.5
250	37	82.2
300	37	90.0
350	37	97.3
400	37	104.0
450	37	110.3
500	37	116.2
550	61	95.0
600	61	99.2
650	61	103.2
700	61	107.1
750	61	110.9
800	61	114.5
900	61	121.5
1000	61	128.0

Aluminum Compact Stranded Conductor Sizes

Compact Aluminum AWG or kcmil	Class ASTM B400	Number of Strands	Conductor Diameter (In.)
#8	A, B	7	.134
#6	A, B	7	.169
#4	A, B	7	.213
#3	A, B	7	.238
#2	AA, A, B	7	.268
#1	AA, A	7	.299
#1	B	19	.299
1/0	AA, A	7	.336
1/0	B	19	.336
2/0	AA, A	7	.376
2/0	B	19	.376
3/0	AA, A	7	.423
3/0	B	19	.423
4/0	AA, A	7	.475
4/0	B	19	.475
250	AA	7	.520
250	A	19	.520
250	B	37	.520
266	AA	7	.337
266	A	19	.337
300	AA	7	.570
300	A	19	.570
300	B	37	.570
336	AA	7	.603
336	A	19	.603
350	A	19	.616
350	B	37	.616
397	AA, A	19	.659
400	B	37	.659
450	B	37	.700
477	AA	19	.722
500	AA	19	.736
500	B	37	.736
550	B	61	.775
556	AA	19	.780
600	B	61	.813
650	B	61	.845
700	B	61	.877
750	B	61	.908
800	B	61	.938
900	B	61	.999
1000	B	61	1.060

A.
System
Overview

B1.
Cable
Ties

B2.
Cable
Accessories

B3.
Stainless
Steel
Ties

C1.
Wiring
Duct

C2.
Surface
Raceway

C3.
Abrasion
Protection

C4.
Cable
Management

D1.
Terminals

D2.
Power
Connectors

D3.
Grounding
Connectors

E1.
Labeling
Systems

E2.
Labels

E3.
Pre-Printed
& Write-On
Markers

E4.
Permanent
Identification

E5.
Lockout/
Tagout
& Safety
Solutions

F.
Index

A.
System
Overview

Common Conductor Sizes and Strandings Reference Chart

B1.
Cable Ties

B2.
Cable
Accessories

B3.
Stainless
Steel Ties

C1.
Wiring
Duct

C2.
Surface
Raceway

C3.
Abrasion
Protection

C4.
Cable
Management

D1.
Terminals

D2.
Power
Connectors

D3.
Grounding
Connectors

E1.
Labeling
Systems

E2.
Labels

E3.
Pre-Printed
& Write-On
Markers

E4.
Permanent
Identification

E5.
Lockout/
Tagout
& Safety
Solutions

F.
Index

Conductor	Individual Strands			Overall Conductor Size			Conductor	Individual Strands			Overall Conductor Size				
	Diameter		Diameter	Diameter		Area		Diameter		Diameter	Diameter		Area		
AWG	Metric mm ²	No.	mm	In.	mm	In.	Circ. MILS	AWG	Metric mm ²	No.	mm	In.	mm	In.	Circ. MILS
	.05	25	.05	.002	.25	.010	97			19	0.25	.010	1.30	.051	1841
	.06	41	.05	.002	.36	.014	159			1	1.13	.044	1.13	.044	1979
26		10	.13	.005	.53	.021	250		1.0	32	.20	.008	1.30	.051	1984
		1	.41	.016	.41	.016	256			7	.43	.017	1.30	.051	2006
		7	.16	.006	.48	.019	278			19	.29	.011	1.47	.058	2426
		19	.10	.004	.51	.020	304			65	.16	.006	1.50	.059	2580
24		41	.08	.003	.58	.023	384	16		*26	.25	.010	1.50	.059	2600
		10	.16	.006	.58	.023	397			1	1.30	.051	1.30	.051	2601
		1	.51	.020	.51	.020	400			105	.13	.005	1.50	.059	2625
		7	.20	.008	.61	.024	448			*7	.51	.020	1.52	.060	2828
22		19	.13	.005	.61	.024	475		1.5	30	.25	.010	1.70	.067	2906
		65	.07	.003	.65	.026	484			21	.30	.012	1.60	.063	2930
		128	.05	.002	.65	.026	496			189	.10	.004	1.90	.075	2930
		32	.10	.004	.65	.026	496			7	.52	.020	1.60	.063	2934
20		14	.16	.006	.65	.026	556		2.5	1	1.38	.054	1.38	.054	2952
		1	.64	.025	.64	.025	625			45	.16	.006	1.85	.073	3786
		16	.16	.006	.76	.030	635			19	.38	.014	1.85	.073	3831
		26	.13	.005	.76	.030	650			1	1.63	.064	1.63	.064	4096
18		7	.25	.010	.76	.030	700	14		*41	.25	.010	1.85	.073	4100
		19	.16	.006	.79	.031	754			*7	.64	.025	1.85	.073	4481
		48	.10	.004	.80	.031	744			50	.25	.010	2.20	.087	4844
		194	.05	.002	.80	.031	752			7	.67	.026	2.10	.083	4871
16		100	.07	.003	.80	.031	760		4.0	35	.30	.012	2.20	.087	4883
		7	.27	.011	.80	.031	791			315	.10	.004	2.20	.087	4883
		12	.21	.008	.80	.031	820			1	1.78	.070	1.78	.070	4911
		21	.16	.006	.80	.031	833			19	.45	.018	2.36	.093	6088
14		7	.30	.012	.90	.035	977	12		*65	.25	.010	2.41	.095	6500
		16	.20	.008	.90	.035	992			165	.16	.006	2.41	.095	6549
		1	.80	.031	.80	.031	992			1	2.06	.081	2.06	.081	6561
		*10	.25	.010	.89	.035	1000			*7	.81	.032	2.44	.096	7168
12		1	.81	.032	.81	.032	1024		6.0	56	.30	.012	3.10	.122	7812
		41	.13	.005	.91	.036	1025			1	2.26	.089	2.26	.089	7917
		26	.16	.006	.91	.036	1032			511	.10	.004	3.00	.118	7921
		*7	.32	.013	.97	.038	1111			19	.52	.020	2.70	.106	7963
10		19	.20	.008	.94	.037	1216	10		37	.40	.016	2.92	.115	9354
		7	.37	.015	1.10	.043	1485			49	.36	.014	2.95	.116	9880
		24	.20	.008	1.20	.047	1488			*7	.98	.039	2.95	.116	10376
		1	1.00	.039	1.00	.039	1550			1	2.59	.102	2.59	.102	10404
8		*16	.25	.010	1.19	0.047	1600		10	*105	.25	.010	2.95	.116	10500
		1	1.02	.040	1.02	.040	1600			84	.30	.012	3.50	.138	11718
		65	.13	.005	1.19	.047	1625			756	.10	.004	3.70	.146	11718
		41	.16	.006	1.19	.047	1627			1	2.76	.109	2.76	.109	11807
6		*7	.40	.016	1.22	.048	1770		6.0	7	1.05	.041	3.20	.126	11962
		19	.25	.010	1.24	.049	1900			19	.64	.025	3.30	.130	12063

*Strandings required for UL and CSA Certification testing.

This chart details the different conductors commonly used in the industry. For each size, either AWG or Metric, various stranding options are listed. Typically the higher stranding is used in applications requiring greater conductor flexibility.

AWG to Metric Wire Crosses	
AWG	Metric (mm ²)
26 – 22	0.1 – 0.5
22 – 18	0.5 – 1.0
16 – 14	1.5 – 2.5
12 – 10	4.0 – 6.0

Common Conductor Sizes and Strandings Reference Chart (continued)

Conductor		Individual Strands			Overall Conductor Size			Conductor		Individual Strands			Overall Conductor Size		
		No.	Diameter		Diameter		Area			No.	Diameter		Diameter		Area
AWG	Metric mm ²			mm	In.	mm	In.	Circ. MILS					mm	In.	Circ. MILS
	6	7	0.107	0.042	3.21	0.126	11840	95	19	2.57	0.101	12.8	0.505	187500	
		1	2.77	0.109	2.77	0.109	11840		37	1.83	0.072	12.5	0.504	187500	
9		7	1.1	0.0432	3.3	0.13	13000	4/0	19	2.89	0.1055	13.4	0.528	211600	
		1	2.91	0.1144	2.91	0.114	13090	120	37	2.06	0.081	14.4	0.567	237.8 kcmil	
8		1	3.26	0.1285	3.25	0.128	16510	250 kcmil	37	2.07	0.0822	14.6	0.575	250 kcmil	
		7	1.23	0.0486	3.7	0.146	16510	300 kcmil	150	37	2.29	0.09	16	0.63	300 kcmil
	10	7	1.37	0.054	4.12	0.162	19740	350 kcmil	37	2.47	0.0973	17.3	0.681	350 kcmil	
		1	3.58	0.141	3.58	0.141	19740	185	37	2.54	0.1	17.8	0.7	365.1 kcmil	
7		7	1.38	0.0545	4.15	0.164	20520	400 kcmil	37	2.64	0.104	18.5	0.728	400 kcmil	
		1	3.67	0.1443	3.67	0.144	20520	240	37	2.9	0.114	20.3	0.798	473.6 kcmil	
6		7	1.55	0.0612	4.66	0.184	26240	500 kcmil	61	2.26	0.089	20.3	0.801	473.6 kcmil	
		1	4.11	0.162	4.11	0.162	26240		37	2.95	0.1162	20.7	0.813	500 kcmil	
	16	7	1.73	0.008	5.13	0.204	31580		61	2.3	0.0905	20.7	0.814	500 kcmil	
5		7	1.75	0.0688	5.24	0.206	33090	300 kcmil	61	2.51	0.099	22.6	0.891	592.1 kcmil	
4		7	1.96	0.0772	5.88	0.232	41740	600 kcmil	61	2.52	0.0992	22.7	0.893	600 kcmil	
	25	7	2.16	0.085	6.48	0.255	49340	700 kcmil	61	2.72	0.1071	24.5	0.964	700 kcmil	
		19	1.32	0.052	6.6	0.26	49340	750 kcmil	61	2.82	0.1109	25.4	0.998	750 kcmil	
3		7	2.2	0.0867	6.61	0.26	52620		91	2.31	0.0908	25.4	0.998	750 kcmil	
2		7	2.47	0.0974	7.42	0.292	66300	400	61	2.9	0.114	26.1	1.026	798.4 kcmil	
	35	7	2.54	0.1	7.62	0.300	69070	800 kcmil	61	2.91	0.1145	26.2	1.031	800 kcmil	
		19	1.55	0.001	7.75	0.305	69070		91	2.38	0.0938	26.2	1.032	800 kcmil	
1		19	1.5	0.0064	8.43	0.332	83690	1000 kcmil	500	61	3.25	0.128	28.3	1.152	986.8 kcmil
	50	19	1.85	0.073	9.27	0.365	98680		91	2.66	0.1048	29.3	1.153	1000 kcmil	
1/0		19	1.59	0.0745	9.46	0.373	10500		625	91	2.97	0.117	32.7	1.287	1233.7 kcmil
2/0		19	2.13	0.0837	10.6	0.419	133100								
	70	19	2.18	0.086	10.9	0.43	138100								
		19	2.59	0.094	11.9	0.47	167800								
3/0		36	1.71	0.0673	12	0.471	167800								

A.
System
Overview

B1.
Cable Ties

B2.
Cable
Accessories

B3.
Stainless
Steel Ties

C1.
Wiring
Duct

C2.
Surface
Raceway

C3.
Abrasion
Protection

C4.
Cable
Management

D1.
Terminals

D2.
Power
Connectors

D3.
Grounding
Connectors

E1.
Labeling
Systems

E2.
Labels

E3.
Pre-Printed
& Write-On
Markers

E4.
Permanent
Identification

E5.
Lockout/
Tagout/
& Safety
Solutions

F.
Index











A. System Overview

Stud Size Chart (Inches/Millimeters)

B1. Cable Ties

B2. Cable Accessories

B3. Stainless Steel Ties





										
Standard Stud Size	#2	#4	#5	#6	#8	#10	1/4"	5/16"	3/8"	7/16"
Stud Size Decimal Equivalent	.086"	.112"	.127"	.138"	.164"	.190"	.250"	.312"	.375"	.438"
Terminal Hole Diameter	.090"	.118"	.130"	.147"	.173"	.204"	.270"	.343"	.392** .406***	.456"
Stud Size Designation in PANDUIT Part Number	2	4	5	6	8	10	14	56	38	76

C1. Wiring Duct

C2. Surface Raceway

C3. Abrasion Protection

C4. Cable Management

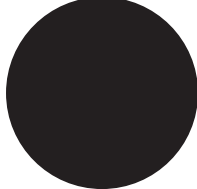
					
Standard Stud Size	1/2"	5/8"	3/4"	7/8"	1"
Stud Size Decimal Equivalent	.500"	.625"	.750"	.875"	1.00"
Terminal Hole Diameter	.531"	.656"	.810"	.906"	1.031"
Stud Size Designation in PANDUIT Part Number	12	58	34	78	1

D1. Terminals

D2. Power Connectors

D3. Grounding Connectors

*Terminal stud.
**Power Connector stud.

Equivalent Tables Decimal/Inches/Millimeters

E1. Labeling Systems

















































































































E2. Labels

E3. Pre-Printed & Write-On Markers

E4. Permanent Identification

E5. Lockout/Tagout & Safety Solutions

F. Index

 	.0156	0,396	 	.2656	6,746	 	.5156	13,100	 	.7656	19,446
 	.0312	0,792	 	.2812	7,143	 	.5312	13,492	 	.7812	14,842
 	.0468	1,189	 	.2968	7,541	 	.5468	13,891	 	.7968	20,241
 	.0625	1,588	 	.3125	7,938	 	.5625	14,288	 	.8125	20,637
 	.0781	1,984	 	.3281	8,337	 	.5781	14,684	 	.8281	21,034
 	.0937	2,380	 	.3375	8,730	 	.5937	15,080	 	.8437	21,480
 	.1093	2,779	 	.3593	9,129	 	.6093	15,479	 	.8593	21,828
 	.125	3,175	 	.375	9,525	 	.625	15,875	 	.875	22,225
 	.1406	3,571	 	.3906	9,921	 	.6406	16,271	 	.8906	22,620
 	.1562	3,968	 	.4062	10,317	 	.6562	16,667	 	.9062	23,017
 	.1718	4,366	 	.4218	10,716	 	.6718	17,066	 	.9218	23,416
 	.1875	4,763	 	.4375	11,113	 	.6875	17,463	 	.9375	23,810
 	.2031	5,159	 	.4531	11,509	 	.7031	17,859	 	.9531	24,208
 	.2187	5,555	 	.4687	11,905	 	.7187	18,255	 	.9687	24,605
	.2343	5,954		.4843	12,304		.7343	18,654		.9843	25,001
	.25	6,350		.5	12,700		.75	19,050		1.	25,400

STRUCTUREDGROUND™ GROUNDING CONNECTORS

PANDUIT® STRUCTUREDGROUND™ Grounding Connectors provide innovative solutions for joining ground conductors to water pipe, ground rods, rebar, conduit, iron pipe and structural steel. Designed with the needs of the end user in mind, STRUCTUREDGROUND™ Grounding Connectors feature easy installation, lowest installed cost, and long-term reliability.



- Functional product information is marked directly on the connector, facilitating the identification, ordering, and usage of the grounding connector
- Compression connectors are color-coded to facilitate quick identification of the proper crimping die
- Mechanical connectors are designed for easy installation – no special tools required
- Incorporate wide wire range-taking capability to minimize inventory requirements
- Made from high strength, high conductivity electrolytic copper and aluminum alloy materials to provide optimum connectivity for both power and grounding applications
- Wide assortment of manual, controlled cycle, battery operated hydraulic and pneumatic crimping tools for reliable connections at the lowest installed cost

PANDUIT® STRUCTUREDGROUND™ Grounding Connectors are designed for use with many different code and flex conductor types and are available in a broad range of styles and sizes. A full line of manual, controlled cycle, and battery operated hydraulic crimping tools meet application needs and provide lowest installed cost. PANDUIT offers a wide variety of STRUCTUREDGROUND™ Grounding Connectors to meet customer needs and today's application requirements.

A.
System
Overview

B1.
Cable Ties

B2.
Cable
Accessories

B3.
Stainless
Steel Ties

C1.
Wiring
Duct

C2.
Surface
Raceway

C3.
Abrasion
Protection

C4.
Cable
Management

D1.
Terminals

D2.
Power
Connectors

D3.
Grounding
Connectors

E1.
Labeling
Systems

E2.
Labels

E3.
Pre-Printed
& Write-On
Markers

E4.
Permanent
Identification

E5.
Lockout/
Tagout
& Safety
Solutions

F.
Index

A. System Overview

Features and Benefits – STRUCTUREDGROUND™ Compression Connectors

B1. Cable Ties

Bolded features are unique to PANDUIT.

B2. Cable Accessories

B3. Stainless Steel Ties

C1. Wiring Duct

C2. Surface Raceway

C3. Abrasion Protection

C4. Cable Management

D1. Terminals

D2. Power Connectors

D3. Grounding Connectors

E1. Labeling Systems

E2. Labels

E3. Pre-Printed & Write-On Markers

E4. Permanent Identification

E5. Lockout/Tagout & Safety Solutions

F. Index

Copper HTAPs

Easy-to-read, color-coded die index number for PANDUIT crimping dies, legible after crimping, for selection

Conductor sizes for each tap pocket marked on part

Part number and agency listings marked on part for easy identification

Slotted design to reduce installation time when used with PANDUIT cable ties (included)

Made from high conductivity copper and electro tin-plated to inhibit corrosion



Clear Covers for Copper HTAPs

Optically clear to allow 360° inspections

Made from high impact strength self-extinguishing plastic with UL94V-0 flammability rating and minimum oxygen index of 28

Built-in flanges retain HTAP in cover
Easy to assemble snap-on design

Molded in flash barriers protect against electrical flash over



Retainer clips to hold labels inside cover*. Retainer clips have a write-on surface for manual marking

Corresponding PANDUIT HTAP part number, voltage rating, and temperature rating molded into cover half for easy identification

Low profile design minimizes space requirements

Flexible fingers closely conform to conductor preventing foreign objects from entering cover

*Labels shown printed with PANDUIT® PANTHER™ LS8E Printer. See page E1.8.

Thin Wall Copper CTAPs

Part number and conductor size marked on part for easy identification

Color-coded for proper crimp die selection

Ribbed design provides high strength

Made from high conductivity wrought copper



Heavy Duty Copper CTAPs

Easy-to-read die index number for selection

Made from heavy wall, extruded, high conductivity copper; provides high strength and premium electrical properties

Part number and conductor size marked on part for easy identification



Access Floor Grounding Clamp



Each part accommodates a wide range of copper conductor sizes – minimizes inventory

Made from high strength cast bronze

Hinged U-bolt bonds to the pedestal with a single bolt to simplify installation

Quad bolt bonds perpendicular MCBN conductors

Bonds to both square and round access floor pedestals



Service Entrance Grounding Roadmap

- Complies with J-STD-607-A and IEEE Std 1100 (IEEE Emerald Book)
- Grounding Equalizer (GE) is required when two or more Telecommunications Bonding Backbones (TBB) are used within a multi-story building; bond TBBs together with a GE at the top floor and at a minimum of every third floor in between

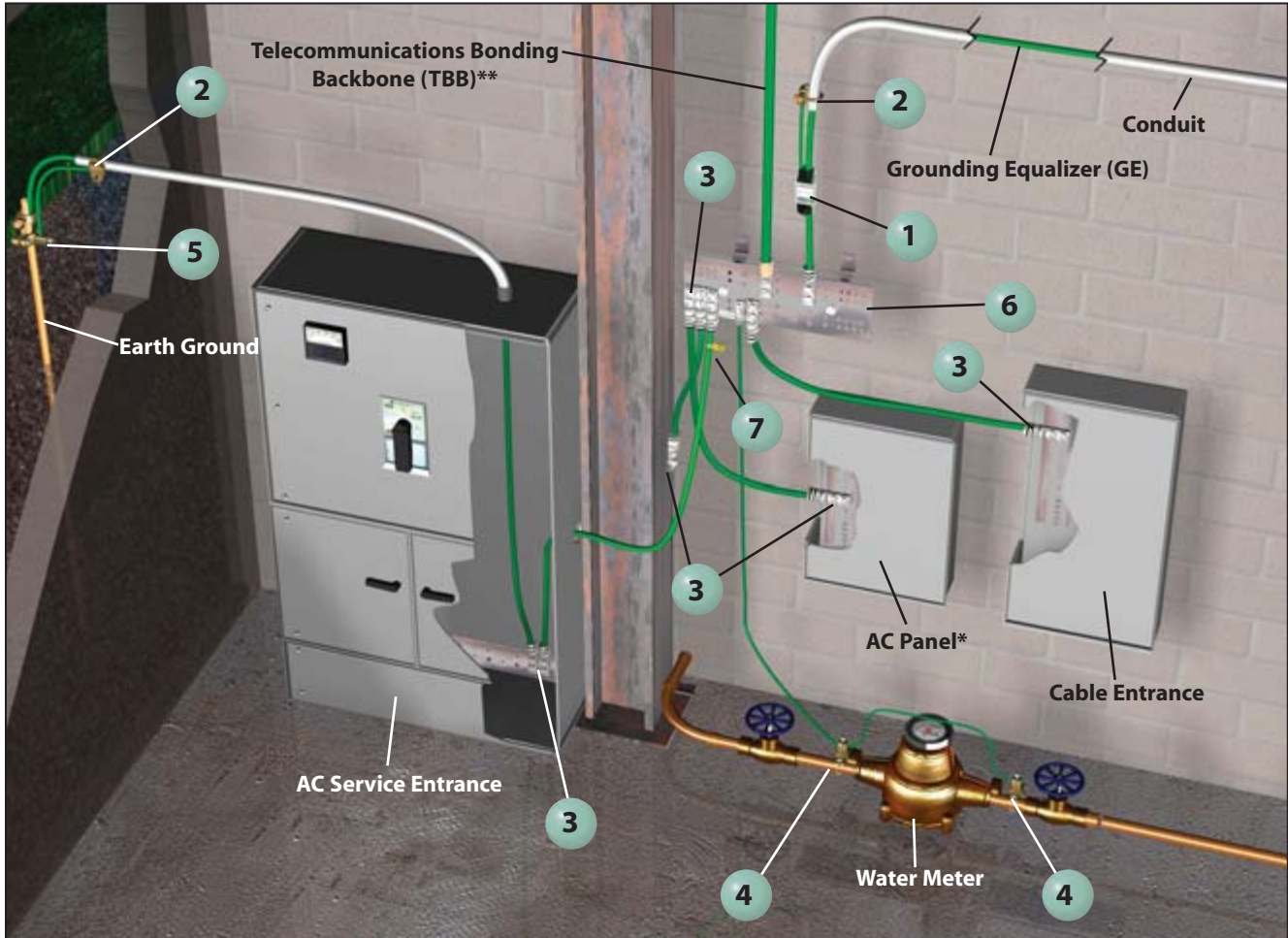

A. System Overview

B1. Cable Ties

B2. Cable Accessories

B3. Stainless Steel Ties

C1. Wiring Duct

C2. Surface Raceway

C3. Abrasion Protection

C4. Cable Management

D1. Terminals

D2. Power Connectors

D3. Grounding Connectors

E1. Labeling Systems







E2. Labels

E3. Pre-Printed & Write-On Markers

E4. Permanent Identification

E5. Lockout/Tagout & Safety Solutions

F. Index

<p>1 Copper Compression HTAP and Clear Cover: HTWC (see pages D3.8 and D3.9)</p> 	<p>5 Bronze, Grounding Rod Clamp: WB (see page D3.25) connected by a cable to 2 (U-Bolt Grounding Clamp)</p> 
<p>2 Bronze, U-Bolt Grounding Clamp: GPL (see page D3.22) connected by a cable to 1 (HTAP)</p> 	<p>6 Telecommunications Main Grounding Busbar (TMGB) and Busbar Label (see page D3.5)</p> 
<p>3 Copper Compression, Two-Hole, Long Barrel with Window Lug: LCC-W (see pages D2.47 – D2.49)</p> 	<p>7 Telecommunications Grounding and Bonding Conductor Label Kit: LTYK (see page D3.5)</p> 
<p>4 Bronze, Water Pipe Grounding Clamp: KP (see page D3.23)</p> 	

*AC Panel should be grounded per NEC standards. Enclosure should be grounded per manufacturer's specifications.

**Specification J-STD-607-A specifies different size conductors based on the length of the Telecommunications Bonding Backbone (TBB).

A. System Overview



Access Floor Grounding Clamp

Type GPQC

- Bonds mesh common bonding network (MCBN) conductors to each other and bonds the access floor pedestals to the conductors
- Made with stainless steel hardware to eliminate zinc whiskers which can dislodge and enter equipment, causing shorts
- Specifically designed to bond perpendicular MCBN conductors per TIA-942

- Bonds to the pedestal with a single bolt to simplify installation
- Accommodates conductors from #6 – 1/0 AWG, minimizes inventory requirements
- Bonds round and square access floor pedestals for greater flexibility

B1. Cable Ties

B2. Cable Accessories

B3. Stainless Steel Ties

C1. Wiring Duct

C2. Surface Raceway

C3. Abrasion Protection

C4. Cable Management

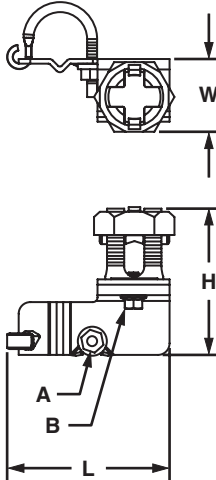
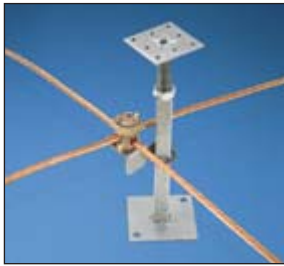

D1. Terminals

D2. Power Connectors

D3. Grounding Connectors

E1. Labeling Systems

E2. Labels

E3. Pre-Printed & Write-On Markers

E4. Permanent Identification

E5. Lockout/Tagout & Safety Solutions

F. Index

Part Number	Round Pedestal In. (mm)	Square Pedestal In. (mm)	MCBN Conductor Size Range AWG (mm ²)	Figure Dimensions In. (mm)					Tightening Torque In.-Lbs. (Nm)		Std. Pkg. Qty.	Std. Ctn. Qty.
				L	W	H	A	B	Conductor	Clamp		
GPQC1/0	3/4 – 7/8 (19.1 – 22.2)	3/4 – 1 (19.1 – 25.4)	#6 – 1/0 (16 – 50)	3.50 (88.9)	1.75 (44.5)	3.50 (88.9)	7/16 (11.1)	3/8 (9.5)	385 (43.5)	150 (17.0)	1	10

cUL^{us} BICSI/J-STD-607-A Telecommunications Grounding Busbars

Type GB

- Meets BICSI and J-STD-607-A requirements for network systems grounding applications
- Made of high conductivity copper and tin-plated to inhibit corrosion
- Comes pre-assembled with brackets and insulators attached for quick installation
- Use *PANDUIT* self-laminating laser/ink jet labels to identify busbars to meet TIA/EIA-606-A, see chart below



TGB



TMGB

Part Number	Bar Size	No. of Mounting Positions		Std. Pkg. Qty.
		1/4" Stud Hole with 5/8" Hole Spacing	3/8" Stud Hole with 1" Hole Spacing	
Telecommunications Grounding Busbars (TGB)				
GB2B0304TPI-1	1/4" x 2" x 10"	4	3	1
GB2B0306TPI-1	1/4" x 2" x 12"	6	3	1
GB2B0312TPI-1	1/4" x 2" x 20"	12	3	1

Telecommunications Main Grounding Busbars (TMGB)				
GB4B0612TPI-1	1/4" x 4" x 12"	12	6	1
GB4B0624TPI-1	1/4" x 4" x 20"	24	6	1

For additional label sizes, materials, and print technologies and to see the complete line of *PANDUIT* identification products, see pages E1.2 – E3.12.

Component Labels for BICSI/J-STD-607-A Telecommunications Grounding Busbars



Suggested Label Solutions for TIA/EIA-606-A Compliance				
Telecommunications Grounding Busbar Part Number	Laser/Ink Jet Desktop Printer Label	TDP43MY Thermal Transfer Desktop Printer Label	PANTHER™ LS8E Hand-Held Printer Label	COUGAR™ LS9 Hand-Held Printer Label
All GB2B and GB4B Parts	C200X100FJJ	C200X100YPT	C200X100FJC	T100X000VPC-BK

For complete labeling solutions and product information, reference charts on pages E1.1 – E2.30.

Telecommunications Grounding and Bonding Conductor Label Kit

- Meets labeling requirements of J-STD-607-A; each telecommunications grounding and bonding conductor shall be labeled as close as practicable to its point of termination in a readable position
- Can be applied as a wrap-around marker (parallel to cable) or flag marker (45° or 90°) to cable
- Kit includes everything needed to properly label cables; ten flame retardant cable ties and ten rigid plastic yellow tags printed with "IF THIS CONNECTOR OR CABLE IS LOOSE OR MUST BE REMOVED, PLEASE CALL THE BUILDING TELECOMMUNICATIONS MANAGER."



Part Number	Part Description	Std. Pkg. Qty.
LTYK	Label kit includes ten printed tags and ten flame retardant cable ties.	1

- A. System Overview
- B1. Cable Ties
- B2. Cable Accessories
- B3. Stainless Steel Ties
- C1. Wiring Duct
- C2. Surface Raceway
- C3. Abrasion Protection
- C4. Cable Management
- D1. Terminals
- D2. Power Connectors
- D3. Grounding Connectors
- E1. Labeling Systems
- E2. Labels
- E3. Pre-Printed & Write-On Markers
- E4. Permanent Identification
- E5. Lockout/Tagout & Safety Solutions
- F. Index

A. System Overview

UL US **CSA CERTIFIED** **Code Conductor, Thin Wall, CTAP**

B1. Cable Ties

For Copper Code Stranded Connections

Type CTAPF

- For copper-to-copper tapping, splicing, or pigtailing
- Wide wire range-taking capability minimizes inventory requirements
- Color-coded for proper crimp die selection
- Ribbed design provides high strength

- Made from high conductivity wrought copper
- UL Listed and CSA Certified to 600 V and temperature rated to 90°C when crimped with *PANDUIT* and specified competitor crimping tools and dies[^]

B2. Cable Accessories

B3. Stainless Steel Ties

C1. Wiring Duct

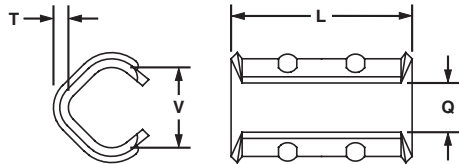

C2. Surface Raceway

C3. Abrasion Protection

C4. Cable Management

D1. Terminals

D2. Power Connectors

D3. Grounding Connectors

E1. Labeling Systems

E2. Labels

E3. Pre-Printed & Write-On Markers

E4. Permanent Identification

E5. Lockout/Tagout & Safety Solutions

F. Index

Part Number	Copper Conductor Size		Number of Ribs	Figure Dimensions In. (mm)				PANDUIT Color Code	Wire Strip Length In. (mm)	Std. Pkg. Qty.
	AWG Run (mm ²)	AWG Tap (mm ²)		L	T	V	Q			
CTAPF10-16-C*	#14 AWG (2.5)	#16 – #14 AWG (1.5 – 2.5)	0	.41 (10.4)	.06 (1.5)	.19 (4.8)	.13 (3.3)	Red	1/2 (12.7)	100
	#12 AWG (4.0)	#16 – #12 AWG (1.5 – 4.0)								
	#10 AWG (6.0)	#14 AWG (2.5)								
CTAPF8-12-C	#10 AWG (6.0)	#10 AWG (6.0)	0	.67 (17.0)	.07 (1.8)	.26 (6.6)	.19 (4.8)	Blue	11/16 (17.5)	100
	#8 AWG (10.0)	#12 AWG (4.0)								
CTAPF6-12-C	#8 AWG (10.0)	#10 – #8 AWG (6.0 – 10.0)	0	.67 (17.0)	.07 (1.8)	.32 (8.1)	.24 (6.1)	Gray	11/16 (17.5)	100
	#6 AWG (16.0)	#12 – #10 AWG (4.0 – 6.0)								
CTAPF4-12-C	#6 AWG (16)	#8 – #6 AWG (10 – 16)	1	1.25 (31.8)	.07 (1.8)	.40 (10.2)	.28 (7.1)	Brown	1 5/16 (33.3)	100
	#5, #4 AWG (16, 25)	#12 – #8 AWG (4 – 10)								
CTAPF3-12-C	#5, #4 AWG (16, 25)	#6 – #5 AWG (16)	1	1.25 (31.8)	.08 (2.0)	.46 (11.7)	.31 (7.9)	Green	1 5/16 (33.3)	100
	#3 AWG (25)	#12 – #6 AWG (4 – 16)								
CTAPF2-12-C	#4 AWG (25)	#4 AWG (25)	1	1.25 (31.8)	.08 (2.0)	.51 (13.0)	.33 (8.4)	Pink	1 5/16 (33.3)	100
	#3 AWG (25)	#5 AWG (16)								
	#2 AWG (35)	#12 – #6 AWG (4 – 16)								
CTAPF1-12-C	#3 AWG (25)	#4 – #3 AWG (25)	2	1.82 (46.2)	.08 (2.0)	.57 (14.5)	.40 (10.2)	Black	1 7/8 (47.6)	100
	#2 AWG (35)	#5 – #4 AWG (16 – 25)								
	#1 AWG (35)	#12 – #5 AWG (4 – 16)								
CTAPF1/0-12-L	#2 AWG (35)	#4 – #2 AWG (25 – 35)	2	1.82 (46.2)	.09 (2.3)	.63 (16.0)	.42 (10.7)	Orange	1 7/8 (47.6)	50
	#1 AWG (35)	#4 – #3 AWG (25)								
	1/0 AWG (50)	#12 – #4 AWG (4 – 25)								
CTAPF2/0-12-Q	#1 AWG (35)	#2 – #1 AWG (35)	2	1.82 (46.2)	.09 (2.3)	.71 (18.0)	.48 (12.2)	Purple	1 7/8 (47.6)	25
	1/0 AWG (50)	#3 – #2 AWG (25 – 35)								
	2/0 AWG (70)	#12 – #3 AWG (4 – 35)								
CTAPF3/0-12-Q	1/0 AWG (50)	#1 – 1/0 AWG (50)	2	1.82 (46.2)	.09 (2.3)	.81 (20.6)	.55 (14.0)	Yellow	1 7/8 (47.6)	25
	2/0 AWG (70)	#2 – #1 AWG (35)								
	3/0 AWG (95)	#12 – #2 AWG (4 – 35)								

See pages D3.88 and D3.89 for tool and die information.
 *CTAPF10-16-C available with square, not flared ends.
 All parts available in tin-plated; add TP before packaging code – example: CTAPF6-12TP-C.
[^]Note: CTAPF parts are UL Listed and CSA Certified with AWG wire only.

UL LISTED Code Conductor, Heavy Duty, CTAP

For Use with Solid and Stranded Copper Code Conductors

Type CTAP

- For tapping into unbroken continuous main, as a wire joint or two-way splice
- Wide wire range-taking capability minimizes inventory requirements
- Made from heavy wall, extruded, high conductivity copper; provides high strength and premium electrical properties

- UL Listed per UL 467 for use up to 35 KV** and temperature rated 90°C when crimped with *PANDUIT* and specified competitor crimping tools and dies
- UL Listed for grounding and bonding suitable for direct burial in earth or concrete when crimped with *PANDUIT* and specified competitor crimping tools and dies[^]

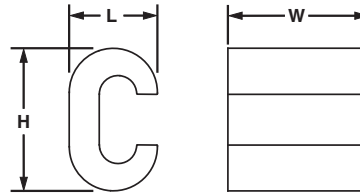

Part Number	Copper Conductor Size		Figure Dimensions In. (mm)			PANDUIT Die Index No.‡	Burdny Die Index No.‡	Wire Strip Length In. (mm)	Tap Cover*	Std. Pkg. Qty.
	AWG Run (mm²)	AWG Tap (mm²)	L	W	H					
CTAP4-8-L	#6 – #4 AWG SOL or STR 16 SOL or STR	#8 AWG SOL or STR 10 SOL or STR	.46 (11.7)	.63 (16.0)	.73 (18.5)	PBG	BG	3/4 (19)	TAPC2-2/0-X	50
CTAP4-6-L	#6 AWG STR, #4 AWG SOL or STR 16 SOL or STR	#6 AWG SOL or STR 95 STR	.48 (12.2)	.63 (16.0)	.76 (19.3)	PBG	BG	3/4 (19)	TAPC2-2/0-X	50
CTAP4-4-L	#4 AWG SOL or STR 16 SOL or STR	#4 AWG STR 16 STR	.46 (11.7)	.63 (16.0)	.81 (20.6)	PBG	BG	3/4 (19)	TAPC2-2/0-X	50
CTAP2-4-Q	#2 AWG SOL or STR 35 SOL or STR	#8 – #4 AWG SOL or STR 10 – 16 SOL or STR	.60 (15.2)	.76 (19.3)	.96 (24.4)	PC	C	7/8 (22)	TAPC2-2/0-X	25
CTAP2-2-X	#2 AWG SOL or STR 35 SOL or STR	#2 AWG SOL or STR 25 SOL or STR	.60 (15.2)	.75 (19.0)	1.05 (26.7)	PC	C	7/8 (22)	TAPC2-2/0-X	10
CTAP2/0-2-X	1/0 – 2/0 AWG STR 70 STR	#8 – #2 AWG SOL or STR 10 – 25 SOL or STR	.80 (20.3)	.93 (23.6)	1.32 (33.5)	PO	O	1 1/16 (27)	TAPC2-2/0-X	10
CTAP2/0-2/0-X	1/0 – 2/0 AWG STR 70 STR	1/0 – 2/0 AWG STR 50 STR	.80 (20.3)	.93 (23.6)	1.37 (34.8)	PO	O	1 1/16 (27)	TAPC2-2/0-X	10
CTAP4/0-2-X	3/0 – 4/0 AWG STR 95 STR	#6 – #2 AWG SOL or STR 16 – 35 SOL or STR	.94 (23.9)	1.08 (27.4)	1.66 (42.2)	PD3	F	1 1/4 (32)	TAPC3/0-4/0-5	10
CTAP4/0-2/0-X	3/0 – 4/0 AWG STR 95 STR	1/0 – 2/0 AWG STR 50 – 70 STR	1.00 (25.4)	1.08 (27.3)	1.57 (39.9)	PD3	F	1 1/4 (32)	TAPC3/0-4/0-5	10
CTAP4/0-4/0-X	3/0 – 4/0 AWG STR 95 STR	3/0 – 4/0 AWG STR 95 STR	1.00 (25.4)	1.08 (27.4)	1.57 (39.9)	PD3	F	1 1/4 (32)	TAPC3/0-4/0-5	10

‡See page D3.90 for tool and die information.

*See page D3.8 for type TAPC CTAP covers.

**Consult cable manufacturer for voltage stress relief instructions with applications greater than 2000 V.

[^]Note: CTAP parts are UL Listed and CSA Certified with AWG wire only.

A. System Overview

B1. Cable Ties

B2. Cable Accessories

B3. Stainless Steel Ties

C1. Wiring Duct

C2. Surface Raceway

C3. Abrasion Protection

C4. Cable Management

D1. Terminals

D2. Power Connectors

D3. Grounding Connectors

E1. Labeling Systems

E2. Labels

E3. Pre-Printed & Write-On Markers

E4. Permanent Identification

E5. Lockout/Tagout & Safety Solutions

F. Index

A. System Overview



Clear Covers for HTCT HTAPs

B1. Cable Ties

For Use with PANDUIT HTCT HTAPs

Type CLRCVR

B2. Cable Accessories

- Made of high impact plastic to provide high impact strength and 360° inspections of crimped connection to assure the crimp is complete and the correct die was used
- Incorporate dual self-latching spring loaded latches and supplied with two PANDUIT UL 94V-0 cable ties to allow for easy snap-on assembly and ensure covers are secured
- Low profile design minimizes space requirements
- Each cover half supports installation information labels inside plastic retainer strips to allow labels to be viewed on either side of cover and to protect labels from being removed

- Incorporate molded in flash barriers which encompass the HTAP installation providing protection against electrical flash over
- UL 94V-0 flame rating and oxygen index of 28 providing self-extinguishing, flame retardant properties
- Part number, voltage rating, temperature rating and HTCT part number molded into cover for easy identification
- See page D3.29 for detailed installation instructions

B3. Stainless Steel Ties

C1. Wiring Duct

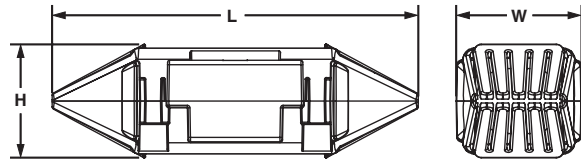

C2. Surface Raceway

C3. Abrasion Protection

C4. Cable Management

Part Number	Use with HTAP Part Number	Figure Dimensions In. (mm)			Std. Pkg. Qty.
		L	W	H	
CLRCVR1-1	HTCT8-8, HTCT6-6	4.48 (113.8)	1.41 (35.8)	1.20 (30.5)	1
CLRCVR2-1	HTCT2-2	5.10 (129.5)	1.66 (42.2)	1.40 (35.6)	1
CLRCVR3-1	HTCT250-8, HTCT250-2, HTCT250-250	5.35 (135.9)	2.16 (54.9)	1.40 (35.6)	1
CLRCVR5-1	HTCT500-250, HTCT500-500	7.50 (190.5)	3.10 (78.7)	1.90 (48.3)	1
CLRCVR6-1	HTCT750-4/0, HTCT750-750, HTCT1000-250, HTCT1000-1000	8.50 (215.9)	4.13 (104.9)	2.40 (61)	1

D1. Terminals

D2. Power Connectors

D3. Grounding Connectors

Black Covers for Copper CTAPs and Aluminum HTAPs

Protect CTAP or HTAP connection from environment and act as insulation

Type TAPC

E1. Labeling Systems

- Used to insulate connectors and protect tap connections from corrosive environments
- Made of durable, weather-resistant black polypropylene

- Double locking latches provide secure cover installation
- Flexible molded fingers at end of covers conform to conductor and prevent foreign objects from contacting connector

E2. Labels

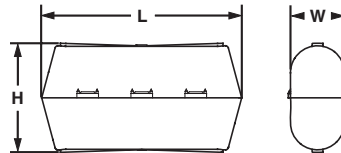

E3. Pre-Printed & Write-On Markers

E4. Permanent Identification

Part Number	Use with CTAP Part Number	Use with HTAP Part Number	Figure Dimensions In. (mm)			Std. Pkg. Qty.
			L	W	H	
TAPC2-2/0-X	CTAP 4-6, CTAP 4-4, CTAP 2-4, CTAP 2-2	HTAP 1-1, HTAP 1/0-1, HTAP 2-8, HTAP 2/0-1	4.62 (117.4)	1.60 (40.6)	2.22 (56.4)	10
TAPC3/0-4/0-5	CTAP 4/0-4/0	HTAP 3/0-1, HTAP 3/0-3/0, HTAP 4/0-2, HTAP 4/0-3/0, HTAP 4/0-4/0	5.65 (143.5)	1.72 (43.7)	2.38 (60.5)	5
TAPC500-2	—	HTAP 500-4/0, HTAP 500-500	6.81 (173.0)	2.86 (72.6)	2.38 (60.5)	2

E5. Lockout/Tagout & Safety Solutions

F. Index

For information on copper CTAPs, see page D3.7.
For information on aluminum HTAPs, see page D2.122.

UL LISTED **CSA CERTIFIED** **Code/Flex Conductor HTAP**

For Making Parallel and Multiple Tap Connections on Code and Flex Conductors

Type HTCT

- Used to tap into continuous conductors as a splice or pigtailling
- Each HTAP terminates a wide range of conductor sizes and combinations of code and flex conductors Class G, H, I and Diesel Locomotive to suit a variety of applications
- Slotted design allows quick and easy assembly of conductor to HTAP using three *PANDUIT* 94V-0 cable ties included
- Tap grooves are separated from one another allowing them to function independently so HTAP can be used with a single or multiple taps providing maximum design and installation flexibility
- Color-coded and marked with *PANDUIT* die index numbers for proper crimp die selection
- UL Listed and CSA Certified for applications up to 600 V when crimped with *PANDUIT* and specified competitor crimping tools and *PANDUIT* crimping dies[†]
- Tin-plated to inhibit corrosion
- See page D3.29 for detailed installation instructions

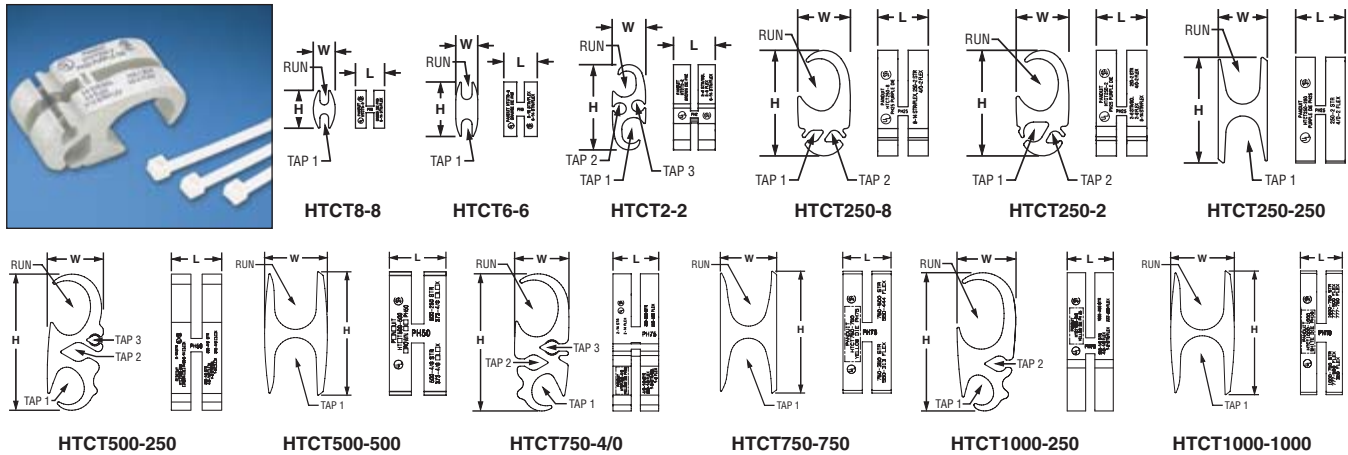

Part Number	Wire Strand Type	Copper Conductor Size Range AWG (mm ²)				Figure Dimensions In. (mm)			PANDUIT Die Color and Die No.‡	Wire Strip Length In. (mm)	Std. Pkg. Qty.
		Run	Tap 1	Tap 2	Tap 3	L	W	H			
HTCT8-8-1	Code	#8 – #14 AWG (6 – 2.5)	#8 – #14 AWG (6 – 2.5)	—	—	.53 (13.5)	.40 (10.2)	.69 (17.5)	Green PH8	19/32 (15)	1
	Flex	#8 – #14 AWG (6 – 2.5)	#8 – #14 AWG (6 – 2.5)	—	—						
HTCT6-6-1	Code	#6 – #10 AWG (10 – 6)	#6 – #14 AWG (10 – 2.5)	—	—	.61 (15.5)	.40 (10.2)	.99 (25.1)	Orange PH6	11/16 (18)	1
	Flex	#6 – #10 AWG (10 – 6)	#6 – #14 AWG (10 – 2.5)	—	—						
HTCT2-2-1	Code	#2 – #6 AWG STR/SOL (25 – 16)	#2 – #6 AWG STR/SOL (25 – 16)	#8 – #14 AWG (6 – 2.5)	#8 – #14 AWG (6 – 2.5)	.76 (19.3)	.61 (15.5)	1.55 (39.4)	Brown PH2	13/16 (21)	1
	Flex	#2 – #8 AWG (25 – 10)	#2 – #8 AWG (25 – 10)	#8 – #14 AWG (6 – 2.5)	#8 – #14 AWG (6 – 2.5)						
HTCT250-8-1	Code	250 kcmil – #2 AWG (120 – 35)	#8 – #14 AWG (6 – 2.5)	#8 – #14 AWG (6 – 2.5)	—	.92 (23.4)	.96 (24.4)	1.92 (48.8)	Purple PH25	1 (25)	1
	Flex	4/0 – #2 AWG (90 – 35)	#8 – #14 AWG (6 – 2.5)	#8 – #14 AWG (6 – 2.5)	—						
HTCT250-2-1	Code	250 kcmil – #2 AWG (120 – 35)	#2 – #6 AWG STR/SOL (25 – 16)	#8 – #14 AWG (6 – 2.5)	—	.92 (23.4)	.96 (24.4)	1.92 (48.8)	Purple PH25	1 (25)	1
	Flex	4/0 – #2 AWG (95 – 35)	#2 – #8 AWG (25 – 10)	#8 – #14 AWG (6 – 2.5)	—						
HTCT250-250-1	Code	250 kcmil – #2 AWG (120 – 35)	250 kcmil – #2 AWG (120 – 35)	—	—	.90 (22.9)	.89 (22.6)	1.92 (48.8)	Purple PH25	1 (25)	1
	Flex	4/0 – #2 AWG (95 – 35)	4/0 – #2 AWG (95° 35)	—	—						

‡See page D3.87 for tool and die information.

^Note: HTCT parts are UL Listed and CSA Certified with AWG wire only.

Table continues on page D3.10

A. System Overview

B1. Cable Ties

B2. Cable Accessories

B3. Stainless Steel Ties

C1. Wiring Duct

C2. Surface Raceway

C3. Abrasion Protection

C4. Cable Management

D1. Terminals

D2. Power Connectors

D3. Grounding Connectors

E1. Labeling Systems

E2. Labels

E3. Pre-Printed & Write-On Markers

E4. Permanent Identification

E5. Lockout/Tagout & Safety Solutions

F. Index

A.
System
Overview

B1.
Cable Ties

B2.
Cable
Accessories

B3.
Stainless
Steel Ties

C1.
Wiring
Duct

C2.
Surface
Raceway

C3.
Abrasion
Protection

C4.
Cable
Management

D1.
Terminals

D2.
Power
Connectors

D3.
Grounding
Connectors

E1.
Labeling
Systems

E2.
Labels

E3.
Pre-Printed
& Write-On
Markers

E4.
Permanent
Identification

E5.
Lockout/
Tagout/
& Safety
Solutions

F.
Index

  **Code/Flex Conductor HTAP (continued)**

Part Number	Wire Strand Type	Copper Conductor Size Range				Figure Dimensions In. (mm)			PANDUIT Die Color and Die No.‡	Wire Strip Length In. (mm)	Std. Pkg. Qty.
		Run	Tap 1	Tap 2	Tap 3	L	W	H			
HTCT500-250-1	Code	500 kcmil – 4/0 AWG (240 – 120)	250 kcmil – 1/0 AWG (120 – 70)	#1 – #6 AWG STR/SOL (35 – 16 STR or SOL)	#8 – #14 AWG —	1.12 (28.4)	1.25 (31.8)	3.03 (77.0)	Brown PH50	1 1/4 (32)	1
	Flex	373 kcmil – 4/0 AWG (185 – 120)	4/0 – 1/0 AWG (95 – 70)	#1 – #8 AWG (35 – 10)	#8 – #14 AWG —						
HTCT500-500-1	Code	500 – 250 kcmil (240 – 150)	500 kcmil – 4/0 AWG (240 – 120)	—	—	1.12 (28.4)	1.24 (31.5)	2.44 (62.0)	Brown PH50	1 1/4 (32)	1
	Flex	373 kcmil – 4/0 AWG (185 – 120)	373 kcmil – 4/0 AWG (185 – 120)	—	—						
HTCT750-4/0-1	Code	750 – 350 kcmil (300 – 185)	4/0 – 1/0 AWG (95 – 70)	#1 – #6 AWGSTR/SOL (35 – 16 STR or SOL)	#2 – #14 AWG (25 – 2.5)	1.25 (31.8)	1.49 (37.8)	3.75 (95.3)	Yellow PH75	1 3/8 (35)	1
	Flex	550 – 500 kcmil (300)	250 kcmil – 1/0 AWG (120 – 70)	#1 – #8 AWG (35 – 10)	#2 – #14 AWG (25 – 2.5)						
HTCT750-750-1	Code	750 – 500 kcmil (300)	750 – 350 kcmil (300 – 185)	—	—	1.25 (31.8)	1.46 (37.1)	3.16 (80.3)	Yellow PH75	1 3/8 (35)	1
	Flex	550 – 444 kcmil (240)	550 – 313 kcmil (240 – 185)	—	—						
HTCT1000-250-1	Code	1000 – 750 kcmil (500 – 400)	250 kcmil – 1/0 AWG (120 – 70)	#1 – #2 AWG (35)	—	1.25 (31.8)	1.59 (40.4)	3.75 (95.3)	Yellow PH75	1 3/8 (35)	1
	Flex	777 – 500 kcmil (400 – 300)	4/0 – 1/0 AWG (95 – 70)	#1 – #2 AWG (35)	—						
HTCT1000-1000-1	Code	1000 – 750 kcmil (500 – 400)	1000 – 750 kcmil (500 – 400)	—	—	1.12 (28.4)	1.70 (43.2)	3.30 (83.8)	White PH10	1 1/4 (32)	1
	Flex	777 – 500 kcmil (400)	777 – 500 kcmil (185)	—	—						
		777 – 750 kcmil (400)	350 kcmil (185)	—	—						

‡See page D3.87 for tool and die information.

^Note: HTCT parts are UL Listed and CSA Certified with AWG wire only.

UL LISTED **CSA CERTIFIED** **Code/Flex Conductor HTAP Kit**

Type HTWC

- Include all components to make a complete HTAP and cover installation: HTCT HTAP, matching CLRCVR clear cover, and cable ties
- Each HTCT HTAP designed to terminate a wide range of copper code and flex conductor combinations to accommodate a variety of applications
- HTAPs incorporate a unique slotted design that allows for quick and easy installation using supplied *PANDUIT* cable ties; saves time and cost

- Matching clear covers are made from high impact plastic and provide high impact strength and 360° viewing of installed HTAP
- Clear covers have a UL 94V-0 flame rating and an oxygen index of 28 providing self-extinguishing, flame retardant properties
- UL Listed and CSA Certified for applications up to 600 V when crimped with *PANDUIT* and specified competitor crimping tools and *PANDUIT* crimping dies
- See page D3.29 for detailed installation instructions

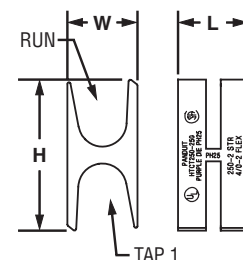
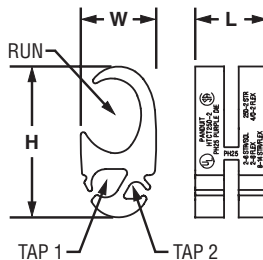
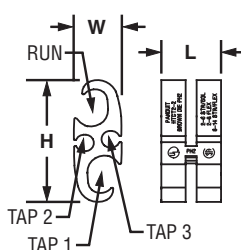
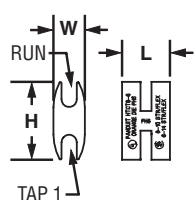

Part Number	Components		Wire Strand Type	Copper Conductor Size Range AWG (mm ²)				Std. Pkg. Qty.
	HTAP Part No.	Clear Cover Part No.		Run	Tap 1	Tap 2	Tap 3	
HTWC8-8-1	HTCT8-8-1	CLRCVR1-1	Code	#8 – #14 AWG (6 – 2.5)	#8 – #14 AWG (6 – 2.5)	—	—	1
			Flex	#8 – #14 AWG (6 – 2.5)	#8 – #14 AWG (6 – 2.5)	(6 – 2.5)	—	
HTWC6-6-1	HTCT6-6-1	CLRCVR1-1	Code	#6 – #10 AWG (10 – 6)	#6 – #14 AWG (10 – 2.5)	—	—	1
			Flex	#6 – #10 AWG (10 – 6)	#6 – #14 AWG (10 – 2.5)	(10 – 2.5)	(6 – 2.5)	
HTWC2-2-1	HTCT2-2-1	CLRCVR2-1	Code	#2 – #6 AWG STR/SOL (25 – 16)	#2 – #6 AWG STR/SOL (25 – 16)	#8 – #14 AWG (6 – 2.5)	#8 – #14 AWG (6 – 2.5)	1
			Flex	#2 – #8 AWG (25 – 10)	#2 – #8 AWG (25 – 10)	#8 – #14 AWG (25 – 10)	#8 – #14 AWG (6 – 2.5)	
HTWC250-8-1	HTCT250-8-1	CLRCVR3-1	Code	250 kcmil – #2 AWG (120 – 35)	#8 – #14 AWG (6 – 2.5)	#8 – #14 AWG (6 – 2.5)	—	1
			Flex	4/0 – #2 AWG (90 – 35)	#8 – #14 AWG (6 – 2.5)	#8 – #14 AWG (6 – 2.5)	—	
HTWC250-2-1	HTCT250-2-1	CLRCVR3-1	Code	250 kcmil – #2 AWG (120 – 35)	#2 – #6 AWG STR/SOL (25 – 16)	#8 – #14 AWG (6 – 2.5)	—	1
			Flex	4/0 – #2 AWG (95 – 35)	#2 – #8 AWG (25 – 10)	#8 – #14 AWG (25 – 10)	—	
HTWC250-250-1	HTCT250-250-1	CLRCVR3-1	Code	250 kcmil – #2 AWG (120 – 35)	250 kcmil – #2 AWG (120 – 35)	—	—	1
			Flex	4/0 – #2 AWG (95 – 35)	4/0 – #2 AWG (95 – 35)	(95 – 35)	—	

See pages D3.8 – D3.10 for more information on HTAPs and clear covers, including tap sizes and locations.
 Note: HTCT parts are UL Listed and CSA Certified with AWG wire only.

Table continues on page D3.12

A. System Overview

B1. Cable Ties

B2. Cable Accessories

B3. Stainless Steel Ties

C1. Wiring Duct

C2. Surface Raceway

C3. Abrasion Protection

C4. Cable Management

D1. Terminals

D2. Power Connectors

D3. Grounding Connectors

E1. Labeling Systems

E2. Labels

E3. Pre-Printed & Write-On Markers

E4. Permanent Identification

E5. Lockout/Tagout & Safety Solutions

F. Index

A.
System
Overview

B1.
Cable Ties



Code/Flex Conductor HTAP Kit (continued)

B2.
Cable
Accessories

B3.
Stainless
Steel Ties

C1.
Wiring
Duct

C2.
Surface
Raceway

C3.
Abrasion
Protection

C4.
Cable
Management

D1.
Terminals

D2.
Power
Connectors

D3.
Grounding
Connectors

E1.
Labeling
Systems

E2.
Labels

E3.
Pre-Printed
& Write-On
Markers

E4.
Permanent
Identification

E5.
Lockout/
Tagout/
& Safety
Solutions

F.
Index

Part Number	Components		Wire Strand Type	Copper Conductor Size Range AWG (mm ²)				Std. Pkg. Qty.
	HTAP Part No.	Clear Cover Part No.		Run	Tap 1	Tap 2	Tap 3	
HTWC500-250-1	HTCT500-250-1	CLRCVR5-1	Code	500 kcmil – 4/0 AWG (240 – 120)	250 kcmil – 1/0 AWG (120 – 70)	#1 – #6 AWG SOL (35 – 16 STR or SOL)	#8 – #14 AWG (6 – 2.5)	1
			Flex	373 kcmil – 4/0 AWG (185 – 120)	4/0 – 1/0 AWG (95 – 70)	#1 – #8 AWG (95 – 70)	#8 – #14 AWG (6 – 2.5)	
HTWC500-500-1	HTCT500-500-1	CLRCVR5-1	Code	500 – 250 kcmil (240 – 150)	500 kcmil – 4/0 AWG (240 – 120)	—	—	1
			Flex	373 kcmil – 4/0 AWG (185 – 120)	373 kcmil – 4/0 AWG (185 – 120)	(185 – 120)	—	
HTWC750-4/0-1	HTCT750-4/0-1	CLRCVR6-1	Code	750 – 350 kcmil (300 – 185)	4/0 – 1/0 AWG (95 – 70)	#1 – #6 AWG STR/SOL (35 – 16 STR or SOL)	#2 – #14 AWG (25 – 2.5)	1
			Flex	550 – 500 kcmil (300)	250 kcmil – 1/0 AWG (120 – 70)	#1 – #8 AWG (120 – 70)	#2 – #14 AWG (25 – 2.5)	
HTWC750-750-1	HTCT750-750-1	CLRCVR6-1	Code	750 – 500 kcmil (300)	750 – 350 kcmil (300 – 185)	—	—	1
			Flex	550 – 444 kcmil (240)	550 – 313 kcmil (240 – 185)	(240 – 185)	—	
HTWC1000-250-1	HTCT1000-250-1	CLRCVR6-1	Code	1000 – 750 kcmil (500 – 400)	250 kcmil – 1/0 AWG (120 – 70)	#1 – #2 AWG (35)	—	1
			Flex	4/0 – 1/0 AWG (95 – 70)	4/0 – 1/0 AWG (95 – 70)	#1 – #2 AWG (95 – 70)	—	
HTWC1000-1000-1	HTCT1000-1000-1	CLRCVR6-1	Code	1000 – 750 kcmil (500 – 400)	1000 – 750 kcmil (500 – 400)	—	—	1
			Flex	777 – 500 kcmil (400)	777 – 500 kcmil (185)	(185)	—	
			Flex	777 – 500 kcmil (400)	350 kcmil (185)	(185)	—	

See pages D3.8 – D3.10 for more information on HTAPs and clear covers, including tap sizes and locations.
Note: HTCT parts are UL Listed and CSA Certified with AWG wire only.

Features and Benefits – STRUCTUREDGROUND™ Mechanical Connectors

Bronze Grounding Clamp



Made from high strength, electrolytic cast bronze

Provides two options: attachment of grounding conductor to clamp either parallel or perpendicular to axis of pipe or ground rod

Provided with high strength, corrosion resistant silicon bronze hardware

Part number, conductor range, rod and pipe size range and "DB" suitable for direct burial marked on part for easy identification

UL LISTED

Bronze Service Post Connector



Part number, conductor range, and "DB" suitable for direct burial marked on part for easy identification

Made from a single piece of hard drawn copper electrolytic rod – provides high strength

Provided with high strength, corrosion resistant silicon bronze nut and pressure pad

Available in configurations for use with one or two copper conductors with either a standard or long stud length

UL LISTED

Bronze Water Pipe Clamp



Part number, conductor range, water pipe size range and "DB" suitable for direct burial marked on part for easy identification

Provided with high strength steel hardware plated to inhibit corrosion

Made from high strength, electrolytic cast bronze

Each part accommodates a wide range of copper conductor sizes and water pipe sizes – minimizes inventory

UL LISTED **CSA CERTIFIED**

Bronze Grounding Clamp



Part number, conductor range, and "DB" suitable for direct burial marked on part for easy identification

Provided with high strength, corrosion resistant silicon bronze hardware

Spacer separates conductor from mounting surface

Made from high strength, electrolytic cast bronze

UL LISTED

Aluminum Lay-In Lug

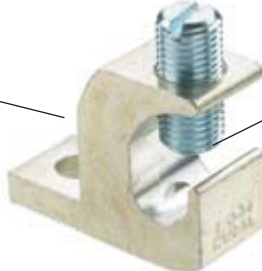

High-density aluminum alloy with tin-plating provides premium electrical and mechanical performance for long-term dependability

Wide wire range-taking supports multiple wires sizes minimizing inventory requirements with minimum parts

UL Listed and CSA Certified for use up to 600 V and UL temperature rated 90°C ensure a high level of safety and reliability

UL LISTED **CSA CERTIFIED**

- A. System Overview
- B1. Cable Ties
- B2. Cable Accessories
- B3. Stainless Steel Ties
- C1. Wiring Duct
- C2. Surface Raceway
- C3. Abrasion Protection
- C4. Cable Management
- D1. Terminals
- D2. Power Connectors
- D3. Grounding Connectors
- E1. Labeling Systems
- E2. Labels
- E3. Pre-Printed & Write-On Markers
- E4. Permanent Identification
- E5. Lockout/Tagout & Safety Solutions
- F. Index

A. System Overview

B1. Cable Ties

B2. Cable Accessories

B3. Stainless Steel Ties

C1. Wiring Duct

C2. Surface Raceway

C3. Abrasion Protection

C4. Cable Management

D1. Terminals

D2. Power Connectors

D3. Grounding Connectors

E1. Labeling Systems

E2. Labels





E3. Pre-Printed & Write-On Markers

E4. Permanent Identification

E5. Lockout/Tagout & Safety Solutions

F. Index

Selection Guide – STRUCTUREDGROUND™ Mechanical Connectors

UL Listed Direct Burial	Service Post Type	Stud Size (In.)	Thread Length (In.)	Copper Code Conductor Size																			
				#12 AWG	#10 AWG	#8 AWG	#7 AWG	#6 AWG	#4 AWG	#3 AWG	#2 AWG	#1 AWG	1/0 AWG	2/0 AWG	3/0 AWG	4/0 AWG	250 kcmil	300 kcmil	350 kcmil	400 kcmil	500 kcmil		
PANDUIT Part Number																							
	Bronze Service Post One Conductor SP1	1/4-20	1/2	SP1-8-C*																			
			1	SP1-8L-C*																			
			1/2		SP1-7-C*																		
			1		SP1-7L-C*																		
		5/16-18	9/16	SP1-4-C*																			
			1	SP1-4L-C*																			
		3/8-16	5/8		SP1-3-C*																		
			1 1/8		SP1-3L-C*																		
			5/8		SP1-2-C																		
		1/2-13	1 1/8		SP1-2L-C																		
			3/4		SP1-1/0-L*																		
		5/8-11	1 1/4		SP1-1/0L-L*																		
			3/4																				
		3/4-10	1 1/4																				
			1																				
		3/4-10	1 1/2																				
			1																				
		3/4-10	1 1/2																				
			1 3/8																				
		3/4-10	1 3/4																				
1 3/4																							
	Bronze Service Post Two Conductors SP2	1/4-20	1/2	SP2-8-C*																			
			1	SP2-8L-C*																			
			1/2		SP2-7-C*																		
			1		SP2-7L-C*																		
		5/16-18	9/16		SP2-4-C*																		
			1		SP2-4L-C*																		
		3/8-16	5/8		SP2-3-C*																		
			1 1/8		SP2-3L-C*																		
			5/8		SP2-2-C*																		
		1/2-13	1 1/8		SP2-2L-C*																		
			3/4																				
		5/8-11	1 1/4																				
			1																				
		3/4-10	1 1/2																				
			1																				
		3/4-10	1 1/2																				
			1 3/8																				
		3/4-10	1 3/4																				
			1 3/4																				
			Bronze Service Post One Conductor SPF1	1/4-20	1/4	SPF1-8-C*																	
5/16-18	5/16				SPF1-7-C*																		
3/8-16	3/8				SPF1-4-C*																		
	7/16				SPF1-3-C																		
1/2-13	1/2				SPF1-2-C																		
	5/8																						
5/8-11	5/8																						
	3/4																						
3/4-10	3/4																						
	1/4																						
	Bronze Service Post Two Conductors SPF2			1/4-20	1/4	SPF2-8-C*																	
					5/16-18	5/16	SPF2-7-C*																
					3/8-16	3/8		SPF2-4-C*															
						7/16		SPF2-3-C*															
				1/2-13	1/2		SPF2-2-C*																
					5/8																		
				5/8-11	5/8																		
					3/4																		
				3/4-10	3/4																		
					1/4																		
		3/4-10	1/2																				
			5/8																				
		3/4-10	3/4																				
			3/4																				

*Denotes minimum conductor size is solid conductor.

A.
System
Overview

B1.
Cable Ties

B2.
Cable
Accessories

B3.
Stainless
Steel Ties

C1.
Wiring
Duct

C2.
Surface
Raceway

C3.
Abrasion
Protection

C4.
Cable
Management

D1.
Terminals

D2.
Power
Connectors

D3.
Grounding
Connectors

E1.
Labeling
Systems

E2.
Labels

E3.
Pre-Printed
& Write-On
Markers

E4.
Permanent
Identification

E5.
Lockout/
Tagout/
& Safety
Solutions

F.
Index

PANDUIT Grounding Connector Approvals



Logo (Symbol)	Agency	Spec/Approval	Applicable Products
	Underwriters Laboratories, Inc.	UL 486A Wire Connectors and Soldering Lugs for use in US and Canada	CLRCVR, HTCT, CTAPF, CTAP
	Underwriters Laboratories, Inc.	UL 486A – 486B Wire Connectors and Soldering Lugs for use in US	LI
	Underwriters Laboratories, Inc.	UL 467 Grounding and Bonding Equipment for use in US and Canada	SP1, SP2, SPF1, SPF2, GPL, GMS, GM
	Underwriters Laboratories, Inc.	UL 467 Grounding and Bonding Equipment for use in US	GPQC, CTAP, KP, WB
	Canadian Standards Association	C22.2 No. 65-03 Wire Connectors	Copper and aluminum compression connectors (except: TAPC and CTAP)
	Canadian Standards Association	C22.2 No. 41-M1987 (R1999) Grounding and Bonding Equipment	GPQC, WB, KP



Service Post Connector, Male Stud, Single Conductor, Bronze

Type SP1

- For grounding one copper code conductor to steel structures, busbars, or transformers or for tapping from busbar with hex nut and washer
- Made from high copper content, hard drawn copper rod provides high strength
- Offered with standard and long stud lengths to accommodate a variety of mounting applications
- Wide wire range-taking capability minimizes inventory requirements
- True hex design for body and nut hex provides correct fit with socket, box, or open end wrenches resulting in proper torquing of electrical connection
- Pressure bar provides secure connection on a full range of conductor combinations used with each connector providing premium wire pull-out strength
- UL Listed for grounding and bonding and suitable for direct burial in earth or concrete

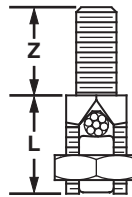

Part Number	Conductor Size Range	Stud Size*	Figure Dimensions In. (mm)		Nut Hex (In.)	Body Hex (In.)	Tightening Torque (In.-Lbs.)	Std. Pkg. Qty.
			L	Z				
SP1-8-C	#12 SOL – #8 STR	1/4 – 20	.63 (16.0)	.50 (12.7)	.50	.38	80	100
SP1-8L-C			.63 (16.0)	1.00 (25.4)				
SP1-7-C	#8 SOL – #7 STR	1/4 – 20	.88 (22.4)	.50 (12.7)	.69	.50	165	100
SP1-7L-C			.88 (22.4)	1.00 (25.4)				
SP1-4-C	#10 SOL – #4 STR	5/16 – 18	.94 (23.9)	.56 (14.2)	.75	.56	240	100
SP1-4L-C			.94 (23.9)	1.00 (25.4)				
SP1-3-C	#6 SOL – #3 STR	3/8 – 16	1.06 (26.9)	.63 (16)	.81	.63	275	100
SP1-3L-C			1.06 (26.9)	1.13 (28.7)				
SP1-2-C	#4 STR – #2 STR	3/8 – 16	1.06 (26.9)	.63 (16)	.88	.69	385	100
SP1-2L-C			1.06 (26.9)	1.13 (28.7)				
SP1-1/0-L	#6 SOL – 1/0 STR	1/2 – 13	1.31 (33.3)	.75 (19.1)	1.00	.75	385	50
SP1-1/0L-L			1.31 (33.3)	1.25 (31.8)				
SP1-2/0-Q	#1 SOL – 2/0 STR	1/2 – 13	1.44 (36.6)	.75 (19.1)	1.13	.88	500	25
SP1-2/0L-Q			1.44 (36.6)	1.25 (31.8)				
SP1-4/0-Q	3/0 SOL – 4/0 STR	5/8 – 11	1.69 (42.9)	1.00 (25.4)	1.38	1.13	650	25
SP1-4/0L-Q			1.69 (42.9)	1.50 (38.1)				
SP1-350-12	4/0 STR – 350 kcmil	5/8 – 11	2.00 (50.8)	1.00 (25.4)	1.50	1.25	650	12
SP1-350L-12			2.00 (50.8)	1.50 (38.1)				
SP1-500-12	250 kcmil – 500 kcmil	3/4 – 10	2.31 (58.7)	1.38 (35.1)	1.81	1.50	825	12
SP1-500L-12			2.31 (58.7)	1.75 (44.5)				

*UNC threads.

A. System Overview

B1. Cable Ties

B2. Cable Accessories

B3. Stainless Steel Ties

C1. Wiring Duct

C2. Surface Raceway

C3. Abrasion Protection

C4. Cable Management

D1. Terminals

D2. Power Connectors

D3. Grounding Connectors

E1. Labeling Systems

E2. Labels

E3. Pre-Printed & Write-On Markers

E4. Permanent Identification

E5. Lockout/Tagout & Safety Solutions

F. Index

A. System Overview

B1. Cable Ties

B2. Cable Accessories

B3. Stainless Steel Ties

C1. Wiring Duct

C2. Surface Raceway

C3. Abrasion Protection

C4. Cable Management

D1. Terminals

D2. Power Connectors

D3. Grounding Connectors

E1. Labeling Systems

E2. Labels

E3. Pre-Printed & Write-On Markers

E4. Permanent Identification

E5. Lockout/Tagout & Safety Solutions

F. Index

UL LISTED **Service Post Connector, Male Stud, Two Conductor, Bronze**
Type SP2

- For grounding two copper code conductors to steel structures, busbars, or transformers or for tapping from busbar with hex nut and washer
- Made from high copper content, hard drawn copper rod provides high strength
- Offered with standard and long stud lengths to accommodate a variety of mounting applications
- Wide wire range-taking capability minimizes inventory requirements
- True hex design for body and nut hex provides correct fit with socket, box, or open end wrenches resulting in proper torquing of electrical connection
- Pressure bar provides secure connection on a full range of conductor combinations used with each connector providing premium wire pull-out strength
- UL Listed for grounding and bonding and suitable for direct burial in earth or concrete

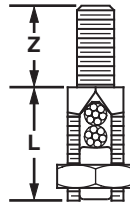

Part Number	Conductor Size Range	Stud Size*	Figure Dimensions In. (mm)		Nut Hex (In.)	Body Hex (In.)	Tightening Torque (In.-Lbs.)	Std. Pkg. Qty.
			L	Z				
SP2-8-C	#12 SOL – #8 STR	1/4 – 20	.75 (19.0)	.50 (12.7)	.50	.38	80	100
SP2-8L-C			.75 (19.0)	1.00 (25.4)				
SP2-7-C	#10 SOL – #7 STR	1/4 – 20	1.00 (25.4)	.50 (12.7)	.69	.50	165	100
SP2-7L-C			1.00 (25.4)	1.00 (25.4)				
SP2-4-C	#10 SOL – #4 STR	5/16 – 18	1.16 (29.5)	.56 (14.2)	.75	.56	240	100
SP2-4L-C			1.16 (29.5)	1.00 (25.4)				
SP2-3-C	#10 SOL – #3 STR	3/8 – 16	1.09 (27.7)	.63 (16)	.81	.63	275	100
SP2-3L-C			1.09 (27.7)	1.13 (28.7)				
SP2-2-C	#10 SOL – #2 STR	3/8 – 16	1.38 (35.1)	.63 (16)	.88	.69	385	100
SP2-2L-C			1.28 (32.5)	1.13 (28.7)				
SP2-1/0-L	#2 SOL – 1/0 STR	1/2 – 13	1.69 (42.9)	.75 (19.1)	1.00	.75	385	50
SP2-1/0L-L			1.69 (42.9)	1.25 (31.8)				
SP2-2/0-Q	#2 SOL – 2/0 STR	1/2 – 13	1.88 (47.8)	.75 (19.1)	1.13	.88	500	25
SP2-2/0L-Q			1.88 (47.8)	1.25 (31.8)				
SP2-4/0-Q	#1 SOL – 4/0 STR	5/8 – 11	2.25 (57.2)	1.00 (25.4)	1.38	1.13	650	25
SP2-4/0L-Q			2.25 (57.2)	1.50 (38.1)				
SP2-350-12	#1 STR – 350 kcmil	5/8 – 11	2.69 (68.3)	1.00 (25.4)	1.50	1.25	650	12
SP2-350L-12			2.69 (68.3)	1.50 (38.1)				
SP2-500-12	3/0 STR – 500 kcmil	3/4 – 10	3.19 (81.0)	1.38 (35.1)	1.81	1.50	825	12
SP2-500L-12			3.19 (81.0)	1.75 (44.5)				

*UNC threads.



Service Post Connector, Female Thread, Single Conductor, Bronze

Type SPF1

- For grounding one copper code conductor to steel structures, busbars, or transformers or for tapping from busbar using external studs, screws, or bolts
- Made from high copper content, hard drawn copper rod provides high strength
- Wide wire range-taking capability minimizes inventory requirements
- True hex design for body and nut hex provides correct fit with socket, box, or open end wrenches resulting in proper torquing of electrical connection
- Pressure bar provides secure connection on a full range of conductor combinations used with each connector providing premium wire pull-out strength
- UL Listed for grounding and bonding and suitable for direct burial in earth or concrete

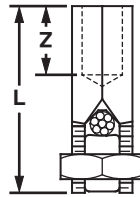

Part Number	Conductor Size Range	Thread Size*	Figure Dimensions In. (mm)		Nut Hex (In.)	Body Hex (In.)	Tightening Torque (In.-Lbs.)	Std. Pkg. Qty.
			L	Z				
SPF1-8-C	#12 SOL – #8 STR	1/4 – 20	.91 (23.1)	.25 (6.4)	.50	.38	80	100
SPF1-7-C	#10 SOL – #7 STR	1/4 – 20	1.13 (28.7)	.25 (6.4)	.69	.50	165	100
SPF1-4-C	#8 SOL – #4 STR	5/16 – 18	1.44 (36.6)	.31 (7.9)	.75	.56	240	100
SPF1-3-C	#6 STR – #3 STR	3/8 – 16	1.50 (38.1)	.38 (9.7)	.81	.63	275	100
SPF1-2-C	#6 STR – #2 STR	3/8 – 16	1.63 (41.4)	.38 (9.7)	.88	.69	385	100
SPF1-1/0-L	#2 SOL – 1/0 STR	1/2 – 13	1.88 (47.8)	.44 (11.2)	1.00	.75	385	50
SPF1-2/0-Q	#1 SOL – 2/0 STR	1/2 – 13	2.06 (52.3)	.50 (12.7)	1.13	.88	500	25
SPF1-4/0-Q	1/0 STR – 4/0 STR	5/8 – 11	2.38 (60.5)	.63 (16)	1.38	1.13	650	25
SPF1-350-12	4/0 STR – 350 kcmil	5/8 – 11	2.63 (66.8)	.63 (16)	1.50	1.25	650	12
SPF1-500-12	300 kcmil – 500 kcmil	3/4 – 10	3.13 (79.5)	.75 (19.1)	1.81	1.50	825	12

*UNC threads.

A. System Overview

B1. Cable Ties

B2. Cable Accessories

B3. Stainless Steel Ties

C1. Wiring Duct

C2. Surface Raceway

C3. Abrasion Protection

C4. Cable Management

D1. Terminals

D2. Power Connectors

D3. Grounding Connectors

E1. Labeling Systems

E2. Labels

E3. Pre-Printed & Write-On Markers

E4. Permanent Identification

E5. Lockout/Tagout & Safety Solutions

F. Index

A.
System
Overview

B1.
Cable Ties

B2.
Cable
Accessories

B3.
Stainless
Steel Ties

C1.
Wiring
Duct

C2.
Surface
Raceway

C3.
Abrasion
Protection

C4.
Cable
Management

D1.
Terminals

D2.
Power
Connectors

D3.
Grounding
Connectors

E1.
Labeling
Systems

E2.
Labels

E3.
Pre-Printed
& Write-On
Markers

E4.
Permanent
Identification

E5.
Lockout/
Tagout
& Safety
Solutions

F.
Index

UL LISTED Service Post Connector, Female Thread, Two Conductor, Bronze

Type SPF2

- For grounding two copper code conductors to steel structures, busbars, or transformers or for tapping from busbar using external threaded studs, screws, or bolts
- Made from high copper content, hard drawn copper rod provides high strength
- Wide wire range-taking capability minimizes inventory requirements
- True hex design for body and nut hex provides correct fit with socket, box, or open end wrenches resulting in proper torquing of electrical connection
- Pressure bar provides secure connection on a full range of conductor combinations used with each connector providing premium wire pull-out strength
- UL Listed for grounding and bonding and suitable for direct burial in earth or concrete

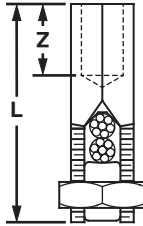

Part Number	Conductor Size Range	Thread Size*	Figure Dimensions In. (mm)		Nut Hex (In.)	Body Hex (In.)	Tightening Torque (In.-Lbs.)	Std. Pkg. Qty.
			L	Z				
SPF2-8-C	#12 SOL – #8 STR	1/4 – 20	1.13 (1.13)	.25 (6.4)	.50	.38	80	100
SPF2-7-C	#10 SOL – #7 STR	1/4 – 20	1.44 (1.44)	.25 (6.4)	.69	.50	165	100
SPF2-4-C	#10 SOL – #4 STR	5/16 – 18	1.56 (1.56)	.31 (7.9)	.75	.56	240	100
SPF2-3-C	#10 SOL – #3 STR	3/8 – 16	1.63 (1.63)	.38 (9.7)	.81	.63	275	100
SPF2-2-C	#10 SOL – #2 STR	3/8 – 16	1.94 (1.94)	.38 (9.7)	.88	.69	385	100
SPF2-1/0-L	#2 SOL – 1/0 STR	1/2 – 13	2.13 (2.13)	.44 (11.2)	1.00	.75	385	50
SPF2-2/0-Q	#2 SOL – 2/0 STR	1/2 – 13	2.31 (2.31)	.50 (12.7)	1.13	.88	500	25
SPF2-4/0-Q	#1 SOL – 4/0 STR	5/8 – 11	2.50 (2.50)	.63 (16)	1.38	1.13	650	25
SPF2-350-12	#1 STR – 350 kcmil	5/8 – 11	2.69 (2.69)	.63 (16)	1.50	1.25	650	12
SPF2-500-12	3/0 STR – 500 kcmil	3/4 – 10	3.31 (3.31)	.75 (19.1)	1.81	1.50	825	12

*UNC threads.



One-Hole Aluminum Lay-In Lug



Type LI

- Used for quick installation of a continuous grounding conductor
- Made from high strength, extruded aluminum alloy to provide premium electrical and mechanical performance
- Tin-plated to inhibit corrosion
- Wide wire range-taking capability minimizes inventory requirements
- UL Listed and CSA Certified for use up to 600 V and UL temperature rated 90°C

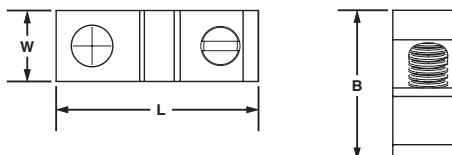

Part Number	Conductor Size Range	Stud Hole Size In.	Hex Key Size (In.)	Figure Dimensions In. (mm)			Tightening Torque (In.-Lbs)	Std. Pkg. Qty.
				L	W	H		
LI-50S-C	#14 – 4 AWG	.22	**	1.07 (27.2)	.38 (9.7)	.78 (19.8)	275	100
LI-112S-L	#14 – 1/0 AWG	.27	**	1.50 (38.1)	.60 (15.2)	1.17 (19.8)	275	50
LI-252S-Q	#6 AWG – 250 kcmil	.33	9/16	2.20 (55.9)	.80 (20.3)	1.79 (45.5)	275	25

The use of PANDUIT oxide inhibiting joint compound (CMP) is recommended for pad to pad and conductor connections. See page D3.21.

**Uses slotted head set screw.

Joint Compounds

Type CMP

- Oxide inhibitor for compression conductor connections lowers electrical resistance of compression joint while sealing out air and moisture to prevent the formation of surface oxides
- Wide operating temperature range; can be used in a wide range of electrical and environmental conditions
- Packaged in convenient dispenser bottles



Part Number	Part Description	Std. Pkg. Qty.
CMP-100-1	Contact aid for pad-to-pad or thread-to-thread aluminum connections, 8 oz. Operating temperature range -60°F (-51°C) to 400°F (204°C).	1
CMP-200-1	Contact aid for cable connections with compression connections made on aluminum conductor, 8 oz. Operating temperature range -40°F (-40°C) to 400°F (204°C). Compatible with all insulating materials.	1
CMP-300-1	Contact aid for copper-to-copper and copper-to-steel connections, 8 oz. Operating temperature range -40°F (-40°C) to 350°F (177°C). Good for all voltages and suitable for grounding. Also used for anti-seizing thread lubricant.	1
CMP-300-4-1	Contact aid for copper-to-copper and copper-to-steel connections, 4 oz. Operating temperature range -40°F (-40°C) to 350°F (177°C). Good for all voltages and suitable for grounding. Also used for anti-seizing thread lubricant.	1

A. System Overview

B1. Cable Ties

B2. Cable Accessories

B3. Stainless Steel Ties

C1. Wiring Duct

C2. Surface Raceway

C3. Abrasion Protection

C4. Cable Management

D1. Terminals

D2. Power Connectors

D3. Grounding Connectors

E1. Labeling Systems

E2. Labels

E3. Pre-Printed & Write-On Markers

E4. Permanent Identification

E5. Lockout/Tagout & Safety Solutions

F. Index

A. System Overview

B1. Cable Ties

B2. Cable Accessories

B3. Stainless Steel Ties

C1. Wiring Duct

C2. Surface Raceway

C3. Abrasion Protection

C4. Cable Management

D1. Terminals

D2. Power Connectors

D3. Grounding Connectors

E1. Labeling Systems

E2. Labels

E3. Pre-Printed & Write-On Markers

E4. Permanent Identification

E5. Lockout/Tagout & Safety Solutions

F. Index

UL LISTED Grounding Clamp, U-Bolt, Bronze

Type GPL

- Used to ground copper conductor parallel or at a right angle to a rod, tube, or pipe
- Made from high strength, electrolytic cast bronze
- High strength silicon bronze hardware provides long term reliable assembly
- Accommodates a wide range of pipe, tube, rod and conductor sizes – minimizes inventory requirements
- UL Listed for grounding and bonding and suitable for direct burial in earth or concrete

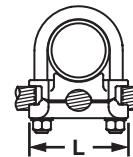
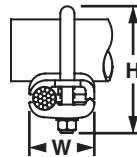

Part Number	Ground Rod Size (In.)	Iron Pipe Size (In.)	Conductor Size Range	Figure Dimensions In. (mm)			Bolt Dia. (In.)	Hex Size (In.)	Tightening Torque (In.-Lbs.)	Std. Pkg. Qty.
				L	W	H				
GPL-4-Q	5/8 or 3/4	3/8	#8 SOL – #4 STR	2.00 (50.8)	1.38 (35.1)	2.75 (69.9)	3/8	9/16	110	25
GPL-5-Q	5/8 or 3/4	3/8	#4 SOL – 2/0 STR	2.00 (50.8)	1.63 (41.4)	2.75 (69.9)	3/8	9/16	180	25
GPL-6-Q	5/8 or 3/4	3/8	2/0 SOL – 250 kcmil	2.00 (50.8)	1.88 (47.8)	2.75 (69.9)	3/8	9/16	240	25
GPL-8-Q	7/8 or 1	1/2 or 3/4	#8 SOL – #4 STR	2.38 (60.5)	1.38 (35.1)	2.63 (66.8)	3/8	9/16	110	25
GPL-9-Q	7/8 or 1	1/2 or 3/4	#4 SOL – 2/0 STR	2.38 (60.5)	1.63 (41.4)	2.63 (66.8)	3/8	9/16	180	25
GPL-10-Q	7/8 or 1	1/2 or 3/4	2/0 SOL – 250 kcmil	2.38 (60.5)	1.88 (47.8)	3.00 (76.2)	3/8	9/16	240	25
GPL-14-X	—	1	#8 SOL – #4 STR	2.63 (66.8)	1.38 (35.1)	2.75 (69.9)	3/8	9/16	110	10
GPL-15-X	—	1	#4 SOL – 2/0 STR	2.63 (66.8)	1.63 (41.4)	2.75 (69.9)	3/8	9/16	180	10
GPL-16-X	—	1	2/0 SOL – 250 kcmil	2.63 (66.8)	1.88 (47.8)	3.25 (82)	3/8	9/16	180	10
GPL-20-X	—	1 1/4	#8 SOL – #4 STR	3.00 (76.2)	1.38 (35.1)	3.50 (88.9)	3/8	9/16	110	10
GPL-21-X	—	1 1/4	#4 SOL – 2/0 STR	3.00 (76.2)	1.63 (41.4)	3.50 (88.9)	3/8	9/16	180	10
GPL-22-X	—	1 1/4	2/0 SOL – 250 kcmil	3.00 (76.2)	1.88 (47.8)	3.50 (88.9)	3/8	9/16	240	10
GPL-26-X	—	1 1/2	#8 SOL – #4 STR	3.25 (82.6)	1.38 (35.1)	4.00 (101.6)	3/8	9/16	110	10
GPL-27-X	—	1 1/2	#4 SOL – 2/0 STR	3.25 (82.6)	1.63 (41.4)	4.00 (101.6)	3/8	9/16	180	10
GPL-28-X	—	1 1/2	2/0 SOL – 250 kcmil	3.25 (82.6)	1.88 (47.8)	4.00 (101.6)	3/8	9/16	240	10
GPL-32-3	—	2	#8 SOL – #4 STR	3.75 (95.3)	1.38 (35.1)	4.25 (107.9)	3/8	9/16	110	3
GPL-33-3	—	2	#4 SOL – 2/0 STR	3.75 (95.3)	1.63 (41.4)	4.25 (107.9)	3/8	9/16	180	3
GPL-34-3	—	2	2/0 SOL – 250 kcmil	3.75 (95.3)	1.88 (47.8)	4.25 (107.9)	3/8	9/16	240	3
GPL-39-3	—	2 1/2	#4 SOL – 2/0 STR	4.25 (107.9)	1.63 (41.4)	5.00 (127)	3/8	9/16	180	3
GPL-40-3	—	2 1/2	2/0 SOL – 250 kcmil	4.25 (107.9)	1.88 (47.8)	5.00 (127)	3/8	9/16	240	3
GPL-44-1	—	3	#8 SOL – #4 STR	4.75 (120.6)	1.38 (35.1)	5.50 (140)	3/8	9/16	180	1
GPL-45-1	—	3	#4 SOL – 2/0 STR	4.75 (120.6)	1.63 (41.4)	5.50 (139.7)	3/8	9/16	180	1
GPL-46-1	—	3	2/0 SOL – 250 kcmil	4.75 (120.6)	1.88 (47.8)	5.50 (139.7)	3/8	9/16	240	1
GPL-51-1	—	3 1/2	#4 SOL – 2/0 STR	5.25 (133.4)	1.63 (41.4)	6.25 (158.8)	3/8	9/16	180	1
GPL-52-1	—	3 1/2	2/0 SOL – 250 kcmil	5.25 (133.4)	1.88 (47.8)	6.25 (158)	3/8	9/16	180	1
GPL-57-1	—	4	#4 SOL – 2/0 STR	5.75 (146.0)	1.63 (41.4)	6.38 (162.1)	3/8	9/16	180	1
GPL-58-1	—	4	2/0 SOL – 250 kcmil	5.75 (146.0)	1.88 (47.8)	6.38 (162.1)	3/8	9/16	240	1

Grounding Clamp, U-Bolt, for Two Cables, Bronze

Type GU

- Used to ground two copper code conductors parallel to a rod, tube, or pipe
- Made from high strength, electrolytic cast bronze
- High strength silicon bronze hardware provides long term reliable assembly
- Accommodates a wide range of pipe, tube, rod and conductor sizes – minimizes inventory requirements

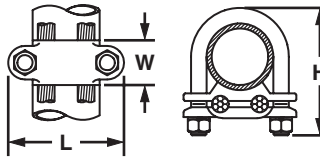

Part Number	Iron Pipe Size (In.)	Conductor Size Range	Figure Dimensions In. (mm)			Bolt Dia. (In.)	Hex Size (In.)	Tightening Torque (In.-Lbs.)	Std. Pkg. Qty.
			L	W	H				
GU-2-X	1	#4 SOL – 2/0 STR	2.75 (70.0)	1.13 (28.6)	3.25 (82.6)	3/8	9/16	240	10
GU-4-X	1 1/4	#8 SOL – #4 STR	3.00 (76.2)	1.13 (28.6)	3.25 (82.6)	3/8	9/16	240	10
GU-13-3	2	300 – 500 kcmil	4.00 (102.0)	1.50 (38.1)	4.63 (118.0)	1/2	3/4	480	3



Grounding Clamp for Water Pipes, Bronze

Type KP

- Used to ground copper code conductor to water pipe or copper tube
- Cast from high strength, electrolytic bronze to provide reliable grounding connections
- Plated steel screws provide high strength and inhibit corrosion
- Accommodates a wide range of pipe, tube, rod and conductor sizes – minimizes inventory requirements
- UL Listed for grounding and bonding and suitable for direct burial in earth or concrete

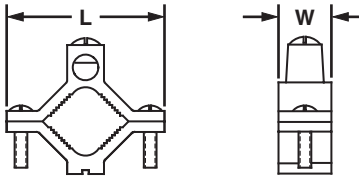

Part Number	Water Pipe Range (In.)	Conductor Size Range	Figure Dimensions In. (mm)		Tightening Torque (In.-Lbs.)		Std. Pkg. Qty.
			L	W	Conductor	Clamp	
KP1-C	1/2 – 1	#10 SOL – #2 STR	2.28 (57.9)	.66 (16.8)	50	50	100
KP2-L	1 1/4 – 2	#10 SOL – #2 STR	3.58 (90.9)	.73 (18.5)	50	50	50

A. System Overview

B1. Cable Ties

B2. Cable Accessories

B3. Stainless Steel Ties

C1. Wiring Duct

C2. Surface Raceway

C3. Abrasion Protection

C4. Cable Management

D1. Terminals

D2. Power Connectors

D3. Grounding Connectors

E1. Labeling Systems

E2. Labels

E3. Pre-Printed & Write-On Markers

E4. Permanent Identification

E5. Lockout/Tagout & Safety Solutions

F. Index

A. System Overview

Grounding Clamp for Water Pipe with Copper Strap, Bronze

B1. Cable Ties

Type KLS

- Used to ground copper code conductor to rigid conduit systems
- Cast from high strength, electrolytic bronze to provide reliable grounding connections
- Plated steel screws provide high strength and inhibit corrosion
- Pure copper contact strip included to isolate conduit system from water pipe vibrations
- High strength bronze conduit hub also included to provide durable connection of conduit to copper strap
- Accommodates a wide range of pipe, tube, and conductor sizes – minimizes inventory requirements

B2. Cable Accessories

B3. Stainless Steel Ties

C1. Wiring Duct

C2. Surface Raceway

C3. Abrasion Protection

C4. Cable Management

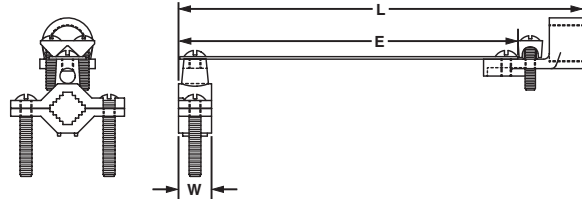

Part Number	Conduit Hub Size	Water Pipe Range (In.)	Conductor Size Range	Figure Dimensions In. (mm)			Tightening Torque (In.-Lbs.)		Std. Pkg. Qty.
				L	W	E	Conductor	Clamp	
KLS-0-Q	1/2	1/2 – 1	#10 SOL – 2/0 STR	8.22 (58.7)	.66 (16.8)	6 7/8 (174.8)	50	50	25
KLS-1-Q	3/4	1/2 – 1	#10 SOL – 2/0 STR	8.22 (58.7)	.66 (16.8)	6 7/8 (174.8)	50	50	25
KLS-1A-X	1	1/2 – 1	#10 SOL – 2/0 STR	8.38 (58.7)	.66 (16.8)	6 7/8 (174.8)	50	50	10

D1. Terminals

Grounding Clamp for Conduit, Bronze

D2. Power Connectors

Type KH

- Used to ground copper code conductor to rigid conduit systems
- Cast from high strength, electrolytic bronze to provide reliable grounding connections
- Plated steel screws provide high strength and inhibit corrosion
- Includes high strength bronze conduit hub to ensure a durable connection of conduit to copper strap
- Accommodates a wide range of pipe, tube, and conductor sizes – minimizes inventory requirements

D3. Grounding Connectors

E1. Labeling Systems

E2. Labels

E3. Pre-Printed & Write-On Markers

E4. Permanent Identification

E5. Lockout/Tagout & Safety Solutions

F. Index

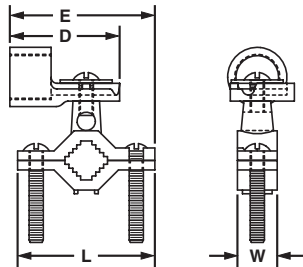

Part Number	Conduit Hub Size	Water Pipe Range (In.)	Conductor Size Range	Figure Dimensions In. (mm)				Tightening Torque (In.-Lbs.)		Std. Pkg. Qty.
				L	W	E	D	Conductor	Clamp	
KH-1-L	1/2	1/2 – 1	#10 SOL – #4 STR	2.31 (58.7)	.66 (16.8)	2.54 (64.5)	1.85 (47)	50	50	50
KH-2-L	1/2	1 1/4 – 2	#10 SOL – #4 STR	3.60 (91.4)	.79 (20.1)	3.02 (76.7)	1.85 (47)	50	50	50

UL LISTED **Grounding Clamp for Water Pipes, Aluminum**

Type GC

- Dual-rated for grounding aluminum or copper code conductors to copper water pipe, galvanized pipe, or steel conduit
- Made from high strength, extruded aluminum alloy to provide long term durability
- Tin-plated to inhibit corrosion and oxidation and for low contact resistance
- Plated steel screws provide high strength and inhibit corrosion
- Accommodates a wide range of pipe, tube, and conductor sizes – minimizes inventory requirements
- UL Listed for grounding and bonding

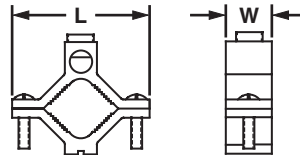

Part Number	Conduit Pipe or Water Tube Size	Conductor Size Range	Figure Dimensions In. (mm)		Tightening Torque (In.-Lbs.)		Std. Pkg. Qty.
			L	W	Conductor	Clamp	
GC-15A-Q	1/2 – 3/4 – 1	#14 – 1/0 AWG	2.25 (57.2)	.69 (17.5)	50	50	25
GC-18A-X	1 1/4 – 1, 1/2 – 2	#6 AWG – 250 kcmil	3.75 (95.3)	.81 (20.6)	50	50	10
GC-22A-4	2 1/2 – 3 – 3 1/2 – 4	#6 AWG – 250 kcmil	6.31 (95.3)	1.00 (25.4)	50	50	4

UL LISTED CERTIFIED **Grounding Rod Clamp, Bronze**

Type WB

- Used for grounding copper conductor parallel to ground rods
- Made from high strength, seamless electrolytic bronze to provide long term durability
- High strength silicon bronze hardware provides long term reliable assembly
- Accommodates a wide range of rod and conductor sizes – minimizes inventory requirements
- UL Listed and CSA Certified for grounding and bonding and suitable for direct burial in earth and concrete

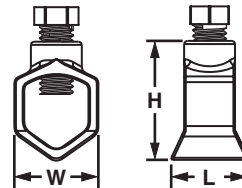

Part Number	Ground Rod Size	Conductor Size Range	Figure Dimensions In. (mm)			Hex Size (In.)	Tightening Torque (In.-Lbs.)	Std. Pkg. Qty.
			L	W	H			
WB12-L	1/2	#2 – #10 STR, #10 SOL	.88 (22.4)	.84 (21.3)	1.28 (32.5)	1/2	180	50
WB34-X	5/8 3/4	1/0 – #8 STR #2 – #8 STR	1.03 (26.2)	1.06 (26.9)	1.54 (39.1)	1/2	180	10
WB58-Q	5/8	1/0 – #8 STR	1.04 (26.4)	.92 (23.4)	1.40 (35.6)	1/2	180	25

A. System Overview

B1. Cable Ties

B2. Cable Accessories

B3. Stainless Steel Ties

C1. Wiring Duct

C2. Surface Raceway

C3. Abrasion Protection

C4. Cable Management

D1. Terminals

D2. Power Connectors

D3. Grounding Connectors

E1. Labeling Systems

E2. Labels

E3. Pre-Printed & Write-On Markers

E4. Permanent Identification

E5. Lockout/Tagout & Safety Solutions

F. Index

A. System Overview

B1. Cable Ties

B2. Cable Accessories

B3. Stainless Steel Ties

C1. Wiring Duct

C2. Surface Raceway

C3. Abrasion Protection

C4. Cable Management

D1. Terminals

D2. Power Connectors

D3. Grounding Connectors

E1. Labeling Systems

E2. Labels

E3. Pre-Printed & Write-On Markers

E4. Permanent Identification

E5. Lockout/Tagout & Safety Solutions

F. Index

UL LISTED **Grounding Clamp with Spacer for Flat Surfaces, Bronze**

Type GM

- Used to ground copper code conductor to flat surfaces
- Cast from high strength, electrolytic bronze to provide reliable grounding connections
- High strength silicon bronze hardware for long term reliable assembly
- Accommodates a wide range of conductor sizes – minimizes inventory requirements
- Incorporates spacer plate to separate conductor from mounting surface
- UL Listed for grounding and bonding and suitable for direct burial in earth or concrete

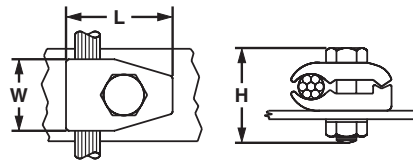

Part Number	Conductor Size Range	Figure Dimensions In. (mm)			Hex Size (In.)		Tightening Torque (In.-Lbs.)	Std. Pkg. Qty.
		L	W	H	Bolt	Nut		
GM-2-Q	#4 SOL – 2/0 STR	1.63 (41.4)	1.13 (28.7)	1.75 (44.5)	9/16	9/16	240	25
GM-3-Q	2/0 SOL – 250 kcmil	2.13 (54.1)	1.50 (38.1)	2.00 (50.8)	3/4	3/4	480	25

UL LISTED **Grounding Clamp for Flat Surfaces, Bronze**

Type GMS

- Used to ground copper code conductor to flat surfaces
- Cast from high strength, electrolytic bronze to provide reliable grounding connections
- High strength silicon bronze hardware for long term reliable assembly
- Accommodates a wide range of conductor sizes – minimizes inventory requirements
- UL Listed for grounding and bonding and suitable for direct burial in earth or concrete

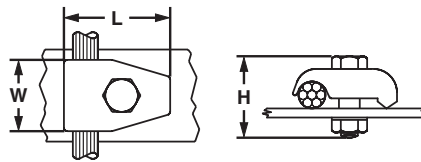

Part Number	Conductor Size Range	Figure Dimensions In. (mm)			Hex Size (In.)		Tightening Torque (In.-Lbs.)	Std. Pkg. Qty.
		L	W	H	Bolt	Nut		
GMS-1-X	#8 SOL – #4 STR	1.25 (31.8)	1.00 (25.4)	1.63 (41.4)	9/16	9/16	240	10
GMS-2-Q	#4 SOL – 2/0 STR	1.63 (41.4)	1.13 (28.7)	1.75 (44.5)	9/16	9/16	240	25
GMS-3-Q	2/0 SOL – 250 kcmil	2.13 (54.1)	1.50 (38.1)	2.00 (50.8)	3/4	3/4	480	25

COMPRESSION CONNECTOR CRIMPING TOOLS

PANDUIT offers a wide range of tools to provide solutions for installing compression lugs and splices. *PANDUIT* installation tools provide quality performance, ease of installation, and lowest installed cost. The long-term reliability of *PANDUIT* installation tools provides the highest level of service to meet and surpass customer requirements.



- Ergonomic design to minimize operator effort
- Controlled cycle mechanisms ensuring reliability and repeatability in every crimp made
- Crimping dies are color-coded to easily match the compression connector to the proper die
- UL Listed and CSA Certified terminations with *PANDUIT* compression connectors, as noted

PANDUIT compression connector crimping tools are available in an assortment of styles including manually operated mechanical and hydraulic, battery operated hydraulic, and AC powered hydraulic to meet a variety of installation needs. *UNI-DIE*[™] Dieless Crimping Tools crimp a variety of sizes and eliminate the need to purchase crimping dies. Fully self-contained battery powered crimping tools provide the ease of push button crimping.

A.
System
Overview

B1.
Cable Ties

B2.
Cable
Accessories

B3.
Stainless
Steel Ties

C1.
Wiring
Duct

C2.
Surface
Raceway

C3.
Abrasion
Protection

C4.
Cable
Management

D1.
Terminals

D2.
Power
Connectors

D3.
Grounding
Connectors

E1.
Labeling
Systems

E2.
Labels

E3.
Pre-Printed
& Write-On
Markers

E4.
Permanent
Identification

E5.
Lockout/
Tagout
& Safety
Solutions

F.
Index

A. System Overview

B1. Cable Ties

B2. Cable Accessories

B3. Stainless Steel Ties

C1. Wiring Duct

C2. Surface Raceway

C3. Abrasion Protection

C4. Cable Management

D1. Terminals

D2. Power Connectors

D3. Grounding Connectors

E1. Labeling Systems

E2. Labels

E3. Pre-Printed & Write-On Markers

E4. Permanent Identification

E5. Lockout/Tagout & Safety Solutions

F. Index

Crimping Guidelines for PANDUIT® PAN-LUG™ Compression Lugs and Splices

1. Select the proper PANDUIT compression connector for the conductor type and size being used.

- PANDUIT compression connectors are identified with the proper conductor size and conductor type marked on the tongue or barrel of the connector



• The proper conductor size and type to be used with each connector can also be found in the installation instructions included with PANDUIT product packaging and in the tool charts* in this catalog

PANDUIT PART NUMBER	STUD WIRE SIZE	WIRE RANGE TAKING WITH MIN-DIE TOOLS (AWG MIN)	WIRE STRIP LENGTH (IN.)	CT-1700
LCB4, LCC4 SCL4	6 AWG	—	1-1/4 1-1/8	RED P21 (3)
LCB4, LCC4 SCL4	6 AWG	—	1-1/4 1-1/8	BLUE P24 (3)
LCB4, LCC4, LCC4-12*** SCL4	2 AWG SCL	4 AWG	1-1/8 1-3/8	GRAY P29 (3)
LCB2, LCC2 SCL2	2 AWG	6-2 AWG	1-1/4 1-1/4	BROWN P33 (3)
LCB1, LCC1 SCL1	1 AWG	6-1 AWG	1-3/8 1-3/8	GREEN P37 (3)
LCB1B, LCC1B SCL1B	1/0 AWG	6-1/0 AWG	1-1/2 1-3/8	—
LCB2B, LCC2B SCL2B	2/0 AWG	4-2/0 AWG	1-5/8 1-1/2	—
LCB3B, LCC3B SCL3B	3/0 AWG	2-3/0 AWG	1-9/16 1-1/2	—

2. Strip the conductor to the proper strip length. As specified:

- On the PANDUIT product packaging label or
- On the installation instructions included with PANDUIT product packaging or
- In the tool charts* in this catalog



Make sure the conductor is not stripped too long, which would result in exposed wire between the barrel of the connector and the cable insulation.

Make sure the conductor is not stripped too short, which would result in a less than complete contact area with the connector when the conductor is inserted in the barrel.

Do not nick or cut strands of conductor during crimping, which would result in a less than premium conductor termination.



Make sure conductor strands are free from corrosion.

3. Select the proper crimping die and crimping tool to be used with the connector.

Use crimping tools and dies that provide a UL Listed and/or CSA Certified electrical termination, to assure a safe and reliable connection.

Many PANDUIT compression connectors are UL Listed and CSA Certified when crimped with PANDUIT and specified competitor crimping tools and dies. These tools and dies are listed in the tool charts* in this catalog. PANDUIT crimping tools and dies to be used with each connector are also listed on the installation instructions included with PANDUIT product packaging.

PANDUIT compression connectors are color-coded and marked with PANDUIT and specified competitor die index numbers. Select the proper crimping die to be used by matching the color code and die index number marked on the connector to the same markings on the crimping die.



4. Crimp the connector.

Insert the conductor into the barrel of the connector. The conductor should stop against the end of the barrel of the lug, or wire stop in the butt splice, upon complete insertion of the conductor in the barrel. Some lugs are offered with inspection windows that provide visual inspection of the complete conductor insertion.



Review the installation instructions included with the PANDUIT product packaging or the tool charts* for the proper number of crimps to be placed in the connector. Make the first crimp in the barrel nearest

WIR. PAK (L2)	(L2)	WIR. PAK (L2)
JD-920-2/0	STD	CD-2001-2/0
ADK P45 (3)	(2)	BLACK P45 (3)
JD-920-3/0	STD	CD-2001-3/0
ANGE P50 (3)	(2)	ORANGE P50 (3)
JD-920-4/0	STD	CD-2001-4/0
RPE P54 (3)	(2)	PURPLE P54 (3)
JD-920-250	STD	CD-2001-250
LOW P62 (3)	(3)	YELLOW P62 (3)
JD-920-300	STD	CD-2001-300
HTE P65 (3)	(2)	WHITE P65 (3)
JD-920-350	STD	CD-2001-350
ED P71 (3)	(3)	RED P71 (3)
JD-920-400	STD	CD-2001-400

the tongue of the lug, or wire stop in a butt splice, and make successive crimps in the barrel working towards the



conductor entry at the end of the barrel. Use the color-coded or knurled band markings on the barrel of the connector to evenly space the placement of the crimps in the barrel.

When properly crimped, the die index number engraved in the crimping die will be embossed into the barrel of the connector. The crimp should be placed in the connector so the die index number can be easily read when the connector is installed.



* See tool charts on pages D3.52 – D3.90.

Crimping Guidelines for PANDUIT® STRUCTUREDGROUND™ Compression Connectors

TAP Installation

1. Locate desired position of TAP along main wire run. Allow clearance for tap wires (and cover installation if applicable). See clear cover table on page D3.8.
2. Strip insulation from wires to the length shown in the TAP tables on pages D3.9 – D3.10. Use care to avoid damaging the conductors.
3. Position wires in the appropriate tap grooves.
4. For easier installation, apply one of the flame retardant cable ties (provided) around the wires and through the slots in the TAP. **The head of the cable tie must be positioned along the side of the TAP as shown in Figure A.** Tension and cut off excess length of tie. Additional cable ties may be used adjacent to the TAP to secure the wires.
5. Install the correct dies (see page D3.87) into the crimping tool. Position the locator die into the stationary die holder. **Note: The color code and die index number shown on the HTAP and crimping dies must match.**
6. Position the TAP against the locator in the stationary die holder of the crimping tool.
7. After crimping, if desired, cut off the cable tie head or remove the entire cable tie. **Note: In some cases, the cable tie head must be cut off in order for the crimped connector to fit inside the insulating cover.**

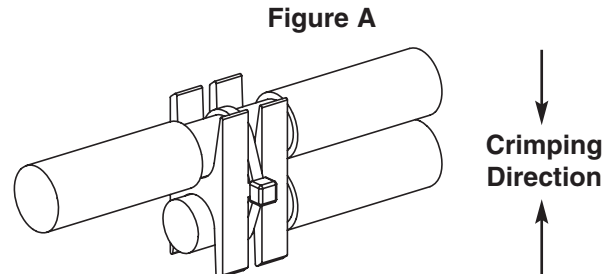

HTAP Cover Installation

1. If labels are being utilized, cut labels to the dimensions shown below. **Note: When using a PANDUIT® PAN-THER™ LS8E printer, the length dimensions can be easily programmed to provide cut-off marks.**
2. Position the label(s) in the pockets inside the cover and snap in the label retainer(s) as shown in Figure B. Information can be marked on the matte finish label retainers in lieu of using a separate label.
3. Position one cover half around the crimped connector assembly. Align the second cover half with the first and snap together.
4. Install the two flame retardant cable ties (provided) in the grooved areas on the cover. Tension and cut off excess lengths of ties.

Label Size Information

Clear Cover Part Number	Label Height (Max.)	Label Length (Wrap-Around Style)	Label Length (Flat Style)
CLRCVR1-1	.38	1.56	1.00
CLRCVR2-1	.38	1.87	1.25
CLRCVR3-1	.38	2.37	1.75
CLRCVR5-1	.38	3.37	2.06
CLRCVR6-1	.38	4.31	2.94

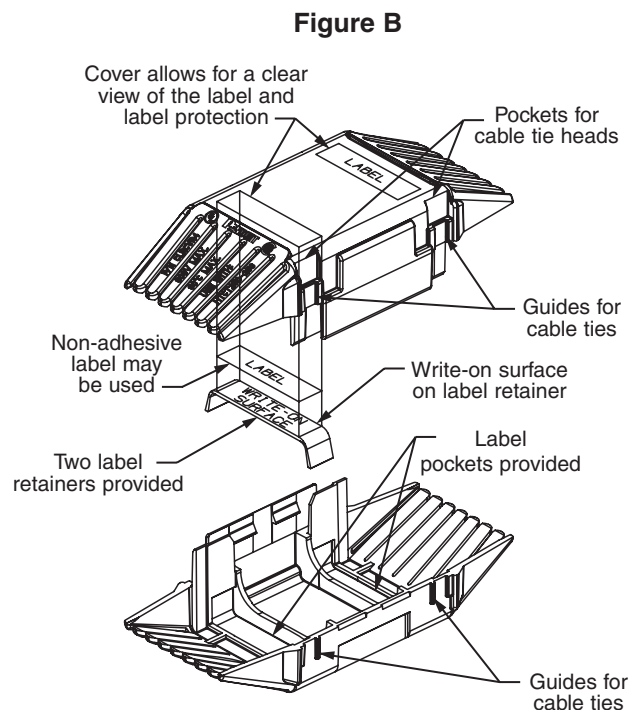

Note: Configuration of cover may differ slightly from illustration.

A. System Overview

B1. Cable Ties

B2. Cable Accessories

B3. Stainless Steel Ties

C1. Wiring Duct

C2. Surface Raceway

C3. Abrasion Protection

C4. Cable Management

D1. Terminals

D2. Power Connectors

D3. Grounding Connectors

E1. Labeling Systems

E2. Labels

E3. Pre-Printed & Write-On Markers

E4. Permanent Identification

E5. Lockout/Tagout & Safety Solutions

F. Index

Selection Guide – Compression Connector Tools (continued)

Tool Selection Guide for Crimping PANDUIT Copper Compression Lugs and Splices for use with Copper Flex Conductor																																									
Conductor Type	Connector Type	Tool Type	Copper Conductor Range																																						
			#8 AWG	#6 AWG	#4 AWG	#3 AWG	#2 AWG	#1 AWG	1/0 AWG	2/0 AWG	3/0 AWG	4/0 AWG	250 kcmil	262 kcmil	300 kcmil	313 kcmil	350 kcmil	373 kcmil	400 kcmil	450 kcmil	500 kcmil	535 kcmil	600 kcmil	646 kcmil	750 kcmil	777 kcmil															
Copper Code and Flex Conductor	LCAX LCAXN LCBX LCDX LCDXN LCCX Maximum Code Conductor Size 4/0 AWG	Manual Crimping Tool	CT-1700 (pg. D1.84)																																						
		Manual Hydraulic Crimping Tool	CT-930 (pg. D3.35)																																						
		Battery Powered Hydraulic Crimping Tools	CT-2001 (pg. D3.36)																																						
			CT-2002 (pg. D3.37)																																						
			CT-2931 (pg. D3.39)																																						
			CT-2940 (pg. D3.40)																																						
			CT-930CH (pg. D3.41)																																						
		Remote Crimp Heads	CT-940CH (pg. D3.42)																																						
		Copper Flex Conductor	LCAF LCCF SCSF RSC	Manual Hydraulic Crimping Tool	CT-930 (pg. D3.35)																																				
Battery Powered Hydraulic Crimping Tools	CT-2931 (pg. D3.39)																																								
	CT-2940 (pg. D3.40)																																								
Remote Crimp Heads	CT-930CH (pg. D3.41)																																								
	CT-940CH (pg. D3.42)																																								

See tool charts on pages D3.52 – D3.90 for selection of crimping dies and number of crimps used with specific tool and connector combinations.

Selection guide continues on page D3.32

A. System Overview

B1. Cable Ties

B2. Cable Accessories

B3. Stainless Steel Ties

C1. Wiring Duct

C2. Surface Raceway

C3. Abrasion Protection

C4. Cable Management

D1. Terminals

D2. Power Connectors

D3. Grounding Connectors

E1. Labeling Systems

E2. Labels

E3. Pre-Printed & Write-On Markers

E4. Permanent Identification

E5. Lockout/Tagout & Safety Solutions

F. Index

A.
System
Overview

Selection Guide – Compression Connector Tools (continued)

B1.
Cable Ties

Tool Selection Guide for Crimping PANDUIT Aluminum Compression Lugs and Splices for use with Copper or Aluminum Code Conductor

Conductor Type	Connector Type	Tool Type	Copper or Aluminum Conductor Range																	
			#6 AWG	#4 AWG	#3 AWG	#2 AWG	#1 AWG	1/0 AWG	2/0 AWG	3/0 AWG	4/0 AWG	250 kcmil	300 kcmil	350 kcmil	400 kcmil	500 kcmil	600 kcmil	750 kcmil	800 kcmil	1000 kcmil
Copper or Aluminum Code Conductor	LAA LAB SA	Manual Crimping Tools	CT-1700 (pg. D1.84)																	
			CT-720 (pgs. D3.34, D1.87)																	
		Manual Hydraulic Crimping Tool	CT-930 (pg. D3.35)																	
		Battery Powered Hydraulic Crimping Tools	CT-2931 (pg. D3.39)																	
			CT-2940 (pg. D3.40)																	
		Remote Crimp Heads	CT-930CH (pg. D3.41)																	
CT-940CH (pg. D3.42)																				

See tool charts on pages D3.52 – D3.90 for selection of crimping dies and number of crimps used with specific tool and connector combinations.

D1.
Terminals

D2.
Power
Connectors

D3.
Grounding
Connectors

E1.
Labeling
Systems

E2.
Labels

E3.
Pre-Printed
& Write-On
Markers

E4.
Permanent
Identification

E5.
Lockout/
Tagout/
& Safety
Solutions

F.
Index

Die Type, Manual, Crimping Tool

- High quality, durable tool construction provides long term dependability



- Develops 6 tons of crimping force, crimps copper compression lugs and splices up to 500 kcmil
- Provides UL Listed and CSA Certified connections on PANDUIT copper and aluminum lugs, splices, and insulated terminals

Part Number	Part Description	Std. Pkg. Qty.
CT-720	Manual crimping tool for UL Listed or Recognized and CSA Certified terminations of PANDUIT® PAN-LUG™ copper compression lugs and splices for #8 AWG – 500 kcmil copper code conductor and aluminum compression lugs and splices for #6 AWG – 350 kcmil copper and aluminum code conductors. Provides UL Listed terminations of PANDUIT® PAN-TERM® #8 – #2 AWG vinyl insulated terminals. Color-coded CD-720 crimping dies, carrying/storage case and controlled cycle mechanism must be purchased separately. Specifications: Output: 6 tons Weight: 7.7 lbs. Length: 26" Handle span: 58" (open), 2.5" (closed) Warranty: 90 days	1
CC-720	Optional controlled cycle mechanism only. Total weight of tool with CC-720 is 8.25 lbs.	1
C-720	Black steel carrying case for CT-720 crimping tool.	1

For battery powered crimping tools, see compression connector tools selection guide on pages D3.30 – D3.32.

CD-720 Crimping Dies

- Color-coded for easy matching to color-coding marked on connectors
- Embosses die index number on connector barrels to provide post crimp inspection except CD-720PV8-2
- Part number permanently marked on crimping die for easy identification
- Provides 5-sided crimp results in terminations with premium electrical and mechanical performance



Part Number	Used to Install PANDUIT Compression Lug and Splice Sizes				Std. Pkg. Qty.
	Copper Conductor Size	Copper Die Color and Die No.	Aluminum Conductor Size	Aluminum Die Color and Die No.	
CD-720-1	#8 – #2 AWG	Red P21, Blue P24, Gray P29, Brown P33	#6 AWG	Gray P29	1
CD-720-2	#1 – 3/0 AWG	Green P37, Pink P42, Black P45, Orange P50	#4 – 1/0 AWG	Green P37, Pink P42, Gold P45, Tan P50	1
CD-720-3	4/0 AWG – 250 kcmil	Purple P54, Yellow P62	2/0 – 3/0 AWG	Olive P54, Ruby P62	1
CD-720-4	300 kcmil	White P66	4/0 AWG	White P66	1
CD-720-5	350 kcmil	Red P71	250 kcmil	Red P71	1
CD-720-6	400 kcmil	Blue P76	300 kcmil	Blue P76	1
CD-720-7	500 kcmil	Brown P87	350 kcmil	Brown P87	1
CD-720PV8-2	#8 – #2 AWG, vinyl insulated PAN-TERM® Terminals	Red, Blue, Yellow	—	—	1

See pages D3.30 – D3.32 for connector and tool selection information.

A. System Overview

B1. Cable Ties

B2. Cable Accessories

B3. Stainless Steel Ties

C1. Wiring Duct

C2. Surface Raceway

C3. Abrasion Protection

C4. Cable Management

D1. Terminals

D2. Power Connectors

D3. Grounding Connectors

E1. Labeling Systems

E2. Labels

E3. Pre-Printed & Write-On Markers

E4. Permanent Identification

E5. Lockout/Tagout & Safety Solutions

F. Index

A. System Overview

Die Type, Manual, Crimping Tool and Die Kits

B1. Cable Ties

- Available with or without controlled cycle feature to meet specific applications
- Kits available with three or full set of seven dies for crimping partial or full range of connector sizes

B2. Cable Accessories



B3. Stainless Steel Ties

C1. Wiring Duct

C2. Surface Raceway

C3. Abrasion Protection

C4. Cable Management

Part Number	Part Description	Std. Pkg. Qty.
CT-720-7	Basic tool kit with seven dies. Includes: <ul style="list-style-type: none"> • Seven dies (CD-720-1 through CD-720-7) for installing #8 AWG – 500 kcmil copper compression connectors • Carrying/storage case (C-720) 	1
CT-720-7CC	Controlled cycle tool kit with seven dies. Controlled cycle mechanism factory installed on crimping tool. Includes: <ul style="list-style-type: none"> • Seven dies (CD-720-1 through CD-720-7) for installing #8 AWG – 500 kcmil copper compression connectors • Carrying/storage case (C-720) 	1
CT-720-3	Basic tool kit with three dies. Includes: <ul style="list-style-type: none"> • Three dies (CD-720-1 through CD-720-3) for installing #8 AWG – 250 kcmil copper compression connectors • Carrying/storage case (C-720) 	1
CT-720-3CC	Controlled cycle tool kit with three dies. Controlled cycle mechanism factory installed on crimping tool. Includes: <ul style="list-style-type: none"> • Three dies (CD-720-1 through CD-720-3) for installing #8 AWG – 250 kcmil copper compression connectors • Carrying/storage case (C-720) 	1

D1. Terminals

Cable Stripping Tool for Large Cable Sizes

D2. Power Connectors

D3. Grounding Connectors

- Provides safe and easy stripping of cable insulation for cables 3/16" to 1 9/16" diameter
- Cutting blade easily adjusts to proper height to cut insulation without nicking conductor strands
- Ergonomic shape for safe comfortable use
- Compact design
- Easy-fit replacement blade, one spare blade included with tool
- Cutting blade provides circular, spiral, and in-line insulation cutting
- Ergonomic shape for safe comfortable use
- Compact design
- Easy-fit replacement blade, one spare blade included with tool
- Spiral cut mode, tough/hard insulations peel off easily
- In-line cut mode for use with softer insulation like neoprene
- Unique blade profile for long life, low friction stripping of difficult insulations like rubber and silicon



Part Number	Wire Range (O.D.)	Part Description	Std. Pkg. Qty.
CST114-157	.18" – 1.57"	Cable stripping tool for stripping insulation from cables 3/16" to 1 9/16" diameter. Includes replacement cutting blade. Warranty: 90 days	1

E1. Labeling Systems

E2. Labels

Wire and Cable Stripping Tools

E3. Pre-Printed & Write-On Markers

- Strips and cuts #20 – #10 AWG wire
- Rust resistant coating included to improve durability of tool
- Lightweight and durable for comfortable long use

E4. Permanent Identification



CST101

E5. Lockout/Tagout & Safety Solutions



CST115

F. Index

Part Number	Wire Range (O.D.)	Part Description	Std. Pkg. Qty.
CST101	#20 – #10 AWG	V notch wire stripper.	1
CST115	#20 – #10 AWG	Plier nose wire stripper.	1

Die Type, Manual Hydraulic, 14 Ton, Crimping Tool

- Develops 14 tons of crimping force, crimps copper compression lugs and splices up to 750 kcmil
- Two-stage rapid advance hydraulic system minimizes number of pumps required to complete a crimp, saves time
- High quality, durable tool construction provides long-term dependability
- Cushioned grip prevents hands from slipping on tool, reduces fatigue
- Provides UL Listed and CSA Certified connections on *PANDUIT® PAN-LUG™* Copper and Aluminum Lugs and Splices and Copper Taps
- Open “C-Head” design allows easy loading of crimping dies and connectors, saves time
- Uses color-coded crimping dies to provide easy matching of crimping die to connector
- Embosses die index number on connector barrels to provide post crimp inspection
- Dies installed using spring loaded die retention pins, no need for tools
- Rubber boot on crimp head provides abrasion protection
- Audible “pop-off” valve indicates crimp completion
- Crimp head rotates 180 degrees, provides versatility for use in restricted spaces



Part Number	Part Description	Std. Pkg. Qty.
CT-930	<p>Terminates <i>PANDUIT® PAN-LUG™</i> Compression Connectors:</p> <ul style="list-style-type: none"> • Copper compression lugs and splices for #8 AWG – 750 kcmil code conductor • Copper compression lugs and splices for #8 AWG – 600 kcmil flex conductor • Copper compression CTAPF taps for #10 – 3/0 AWG code conductor • Copper compression CTAP taps for #8 – 4/0 AWG code conductor • Copper compression HTCT taps for #14 AWG – 250 kcmil code conductor, #14 – 4/0 AWG flex conductor • Aluminum compression lugs and splices for #6 AWG – 600 kcmil code conductor • Aluminum compression HTAPs for #14 AWG – 500 kcmil code conductor • <i>PANDUIT® PAN-TERM®</i> Tubular Terminals for #8 AWG – 250 kcmil code conductor <p>Specifications: Output: 14 tons Jaw opening: 1.65" Weight: 16.5 lbs. Length: 25" Handle span: 17 1/2" (open), 6" (closed) Warranty: 5 years</p> <p>CT-930 includes: • Tool • Plastic tool case with die storage</p>	1

Uses CD-920 and CD-930 color-coded crimping dies. Dies must be purchased separately, see pages D3.46. CG-920 crimp force measurement gauge available, sold separately see page D3.51.

A.
System
Overview

B1.
Cable Ties

B2.
Cable
Accessories

B3.
Stainless
Steel Ties

C1.
Wiring
Duct

C2.
Surface
Raceway

C3.
Abrasion
Protection

C4.
Cable
Management

D1.
Terminals

D2.
Power
Connectors

D3.
Grounding
Connectors

E1.
Labeling
Systems

E2.
Labels

E3.
Pre-Printed
& Write-On
Markers

E4.
Permanent
Identification

E5.
Lockout/
Tagout
& Safety
Solutions

F.
Index

A.
System
Overview

Die Type, Battery Powered Hydraulic, 6 Ton, Crimping Tool with Closed Head

B1.
Cable Ties

- Battery powered, provides fingertip operation
- Self-contained unit, completely portable
- Lightweight and ergonomically balanced for easy operation without fatigue
- Develops 6 tons of crimping force, crimps copper compression lugs and splices up to 500 kcmil
- Provides UL Listed and CSA Certified connections on *PANDUIT® PAN-LUG™* Copper Lugs, Splices, and Taps
- Audible "pop-off" valve indicates crimp completion
- Tool provided with two, NiCd rechargeable batteries and battery charger to allow for continuous operation
- High productivity, up to 80 crimps on 500 kcmil copper lugs and splices on a single battery charge
- Six to eight second crimp cycle time provides quick terminations, saves time

- Battery charger charges expended batteries completely in 25 minutes
- Battery charger includes battery reconditioner feature which prevents battery memory build-up and provides over 1,000 battery recharge cycles resulting in long life
- Uses color-coded crimping dies to provide easy matching of crimping die to connector
- Embosses die index number on connector barrels to provide post crimp inspection
- Dies installed using spring loaded die retention pins, no need for tools
- Crimp head rotates 180 degrees to provide versatility for use in restricted spaces

B2.
Cable
Accessories

B3.
Stainless
Steel Ties

C1.
Wiring
Duct

C2.
Surface
Raceway

C3.
Abrasion
Protection

C4.
Cable
Management



D1.
Terminals

D2.
Power
Connectors

D3.
Grounding
Connectors

E1.
Labeling
Systems

E2.
Labels

E3.
Pre-Printed
& Write-On
Markers

E4.
Permanent
Identification

E5.
Lockout/
Tagout/
& Safety
Solutions

F.
Index

Part Number	Part Description	Std. Pkg. Qty.
CT-2001	<p>Terminates <i>PANDUIT® PAN-LUG™</i> Compression Connectors:</p> <ul style="list-style-type: none"> • Copper compression lugs and splices for #8 AWG – 500 kcmil code conductor • Copper compression lugs for #8 AWG – 350 kcmil flex conductor • Copper compression CTAPF taps for #10 – 3/0 AWG code conductor • Copper compression CTAP taps for #8 – #2 AWG code conductor • <i>PANDUIT® PAN-TERM®</i> Tubular Terminals for #8 AWG – 250 kcmil code conductor <p>Specifications: Output: 6 tons Jaw opening: 1.8" Weight: 8.5 lbs. with battery Length: 13" Height: 12" Width: 3" Warranty: 3 years on tool, 5 years on batteries</p> <p>CT-2001 includes:</p> <ul style="list-style-type: none"> • Tool • Two CT-NLBC25, 14.4 VDC rechargeable batteries (non-LED) • One CT-CHR25 battery charger • One shoulder strap • Plastic tool case with storage for batteries, charger, shoulder strap and crimping dies • Tool incorporates D3 die pocket (included with tool) 	1

Uses color-coded CD-2001 crimping dies. Dies must be purchased separately, see page D3.38.
 For battery charger and battery accessories, see page D3.51.

Die Type, Battery Powered Hydraulic, 6 Ton, Crimping Tool with Open “C-Head”

- Battery powered, provides fingertip operation
- Self-contained unit, completely portable
- Lightweight and ergonomically balanced for easy operation without fatigue
- Develops 6 tons of crimping force, crimps copper compression lugs and splices up to 500 kcmil
- Provides UL Listed and CSA Certified connections on *PANDUIT® PAN-LUG™* Copper Lugs, Splices, and Taps
- Open “C-Head” design allows easy loading of crimping dies and connectors, saves time
- Rubber boot on crimp head provides abrasion protection
- Audible “pop-off” valve indicates crimp completion
- Tool provided with two, NiCd rechargeable batteries and battery charger to allow for continuous operation
- High productivity, up to 80 crimps on 500 kcmil copper lugs and splices on a single battery charge
- Six to eight second crimp cycle time provides quick terminations, saves time
- Battery charger charges expended batteries completely in 25 minutes
- Batteries include LED battery charge indicators for visual indication of current battery charge
- Battery charger includes battery reconditioner feature which prevents battery memory build-up and provides over 1,000 battery recharge cycles resulting in long life
- Uses color-coded crimping dies to provide easy matching of crimping die to connector
- Embosses die index number on connector barrels to provide post crimp inspection
- Dies installed using spring loaded die retention pins, no need for tools
- Crimp head rotates 180 degrees to provide versatility for use in restricted spaces



Part Number	Part Description	Std. Pkg. Qty.
CT-2002	<p>Terminates <i>PANDUIT® PAN-LUG™</i> Compression Connectors:</p> <ul style="list-style-type: none"> • Copper compression lugs and splices for #8 AWG – 500 kcmil code conductor • Copper compression lugs for #8 AWG – 350 kcmil flex conductor • Copper compression CTAPF taps for #10 – 3/0 AWG code conductor • Copper compression CTAP taps for #8 – #2 AWG code conductor • <i>PANDUIT® PAN-TERM®</i> Tubular Terminals for #8 AWG – 250 kcmil code conductor <p>Specifications: Output: 6 tons Jaw opening: .95" Weight: 9.0 lbs. with battery Length: 13" Height: 12" Width: 3" Warranty: 5 years tool, 1 year on batteries</p> <p>CT-2002 includes:</p> <ul style="list-style-type: none"> • Tool • Two CT-BC25, 14.4 VDC rechargeable batteries with LED display • One CT-CHR25 battery charger • One shoulder strap • Plastic tool case with storage for batteries, shoulder strap, and crimping dies • Tool incorporates D3 die pocket (included with tool) 	1

Uses color-coded CD-2001 crimping dies. Dies must be purchased separately, see page D3.38. For battery charger and battery accessories, see page D3.51.

A.
System
Overview

B1.
Cable Ties

B2.
Cable
Accessories

B3.
Stainless
Steel Ties

C1.
Wiring
Duct

C2.
Surface
Raceway

C3.
Abrasion
Protection

C4.
Cable
Management

D1.
Terminals

D2.
Power
Connectors

D3.
Grounding
Connectors

E1.
Labeling
Systems

E2.
Labels

E3.
Pre-Printed
& Write-On
Markers

E4.
Permanent
Identification

E5.
Lockout/
Tagout
& Safety
Solutions

F.
Index

A.
System
Overview

CD-2001 Crimping Dies

B1.
Cable Ties

- Color-coded to provide easy matching to color-coding marked on connectors
- Embosses die index number on connector barrels to provide post crimp inspection

- Part number permanently marked on crimping die for easy identification
- Provide circumferential crimp results in terminations with premium electrical and mechanical performance

B2.
Cable
Accessories



CD-2001

B3.
Stainless
Steel Ties

C1.
Wiring
Duct

C2.
Surface
Raceway

C3.
Abrasion
Protection

C4.
Cable
Management

D1.
Terminals

D2.
Power
Connectors

D3.
Grounding
Connectors

E1.
Labeling
Systems

E2.
Labels

E3.
Pre-Printed
& Write-On
Markers

E4.
Permanent
Identification

E5.
Lockout/
Tagout
& Safety
Solutions

F.
Index

Part Number	Used to Install <i>PANDUIT</i> Compression Lug and Splice Sizes				Std. Pkg. Qty.
	Copper Code Conductor Size	Copper Die Color and Die No.	Aluminum Code Conductor Size	Aluminum Die Color and Die No.	
CD-2001-8	#8 AWG	Red P21	—	—	1
CD-2001-6	#6 AWG	Blue P24	—	—	1
CD-2001-4	#4 AWG STR #3 AWG STR #2 AWG SOL	Gray P29	#6 AWG	Gray P29	1
CD-2001-2	#2 AWG	Brown P33	—	—	1
CD-2001-1	#1 AWG	Green P37	#4 AWG	Green P37	1
CD-2001-1/0	1/0 AWG	Pink P42	#2 AWG	Pink P42	1
CD-2001-2/0	2/0 AWG	Black P45	#1 AWG	Gold P45	1
CD-2001-3/0	3/0 AWG	Orange P50	1/0 AWG	Tan P50	1
CD-2001-4/0	4/0 AWG	Purple P54	2/0 AWG	Olive P54	1
CD-2001-250	250 kcmil	Yellow P62	3/0 AWG	Ruby P62	1
CD-2001-300	300 kcmil	White P66	4/0 AWG	White P66	1
CD-2001-350	350 kcmil	Red P71	250 kcmil	Red P71	1
CD-2001-400	400 kcmil	Blue P76	300 kcmil	Blue P76	1
CD-2001-500	500 kcmil	Brown P87	—	—	1

Part Number	Used to Install <i>PANDUIT</i> Tap Part Numbers			Std. Pkg. Qty.
	Copper Tap	Die Color and Die No.	Aluminum Tap	
Single Crimp Dies				
CD-2001-8	CTAPF10-16-C	Red P21	—	1
CD-2001-6	CTAPF8-12-C	Blue P24	—	1
CD-2001-4	CTAPF6-12-C	Gray P29	—	1
CD-2001-2	CTAPF4-12-C	Brown P33	—	1
CD-2001-1	CTAPF3-12-C	Green P37	—	1
CD-2001-1/0	CTAPF2-12-C	Pink P42	—	1
CD-2001-2/0	CTAPF1-12-C	Black P45	—	1
CD-2001-3/0	CTAPF1/0-12-L	Orange P50	HTAP2-8-L	1
CD-2001-4/0	CTAPF2/0-12-Q	Purple P54	—	1
CD-2001-250	CTAPF3/0-12-Q	Yellow P62	—	1
CD-2001-BG	CTAP4-4-L to CTAP4-8-L	PBG	—	1
CD-2001-C	CTAP2-4-Q to CTAP2-2-X	PC	—	1
CD-2001-O	—	Green PO	HTAP1-1-Q to HTAP2/0-1-Q	1

Multi-Crimp Dies

CDM-2001-2	CTAPF4-12-C	Brown P33M	—	1
CDM-2001-1	CTAPF3-12-C	Green P37M	—	1
CDM-2001-1/0	CTAPF2-12-C	Pink P42M	—	1
CDM-2001-2/0	CTAPF1-12-C	Black P45M	—	1
CDM-2001-3/0	CTAPF1/0-12-L	Orange P50M	—	1

See pages D3.52 – D3.90 for connector and tool selection information.

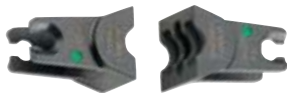

CDM-2001

Die Type, Battery Powered Hydraulic, 12 Ton, Crimping Tool

- Battery powered, provides fingertip operation
- Self-contained unit, completely portable
- Develops 12 tons of crimping force, crimps copper compression lugs and splices up to 750 kcmil
- 2-stage rapid advance hydraulic system minimizes cycle time
- Provides UL Listed and CSA Certified connections on *PANDUIT® PAN-LUG™* Copper and Aluminum Lugs and Splices and Copper Taps
- Open “C-Head” design allows easy loading of crimping dies and connectors, saves time
- Rubber boot on crimp head provides abrasion protection
- Ram automatically retracts when crimp cycle is complete
- Tool provided with two, high capacity 12 VDC rechargeable nickel-metal hydride batteries to provide for continuous operation and eliminate “memory” build-up, one hour charge time
- Eight second crimp cycle time provides quick terminations, saves time
- Uses industry standard MAKITA® batteries and charger, industry proven reliability easy to obtain from local retail sources
- Uses color-coded crimping dies to provide easy matching of crimping die to connector
- Embosses die index number on connector barrels to provide post crimp inspection
- Dies installed using spring loaded die retention pins, no need for tools
- Crimp head rotates 360 degrees to provide versatility for use in restricted spaces



Part Number	Part Description	Std. Pkg. Qty.
CT-2931	<p>Terminates <i>PANDUIT® PAN-LUG™</i> Compression Connectors:</p> <ul style="list-style-type: none"> • Copper compression lugs and splices for #8 AWG – 750 kcmil code conductor • Copper compression lugs and splices for #8 AWG – 600 kcmil flex conductor • Copper compression CTAPF taps for #10 – 3/0 AWG code conductor • Copper compression CTAP taps for #8 – 4/0 AWG code conductor • Copper compression HTCT taps for #14 AWG – 250 kcmil code conductor, #14 – 4/0 AWG flex conductor • Aluminum compression lugs and splices for #6 AWG – 600 kcmil code conductor • Aluminum compression HTAPs for #14 AWG – 500 kcmil code conductor • <i>PANDUIT® PAN-TERM®</i> Tubular Terminals for #8 AWG – 250 kcmil code conductor <p>Specifications: Output: 12 tons Jaw opening: 1.65" Weight: 15.2 lbs with battery Length: 15 5/8" Height: 12" Width: 3 3/16" Warranty: 3 years</p> <p>CT-2931 includes: • Tool • Two 12 VDC, rechargeable NiMH batteries • One battery charger, 115 VAC • Steel tool case with storage for batteries, charger, and crimping dies</p>	1

Uses CD-920 and CD-930 color-coded crimping dies. Dies must be purchased separately, see page D3.46. CG-920 crimp force measurement gauge available, sold separately, see page D3.51.

*MAKITA is a registered trademark of Makita Corporation.

A. System Overview

B1. Cable Ties

B2. Cable Accessories

B3. Stainless Steel Ties

C1. Wiring Duct

C2. Surface Raceway

C3. Abrasion Protection

C4. Cable Management

D1. Terminals

D2. Power Connectors

D3. Grounding Connectors

E1. Labeling Systems

E2. Labels

E3. Pre-Printed & Write-On Markers

E4. Permanent Identification

E5. Lockout/Tagout & Safety Solutions

F. Index

A. System Overview

Die Type, Battery Powered Hydraulic, 15 Ton, Crimping Tool

B1. Cable Ties

- Battery powered, provides fingertip operation
- Self-contained unit, completely portable
- Develops 15 tons of crimping force, crimps copper compression lugs and splices up to 1,000 kcmil

B2. Cable Accessories

- Provides UL Listed and CSA Certified connections on *PANDUIT® PAN-LUG™* Copper and Aluminum Lugs and Splices and Copper Taps

B3. Stainless Steel Ties

- Flip-top crimp head design allows easy loading of crimping dies and connectors, saves time
- Rubber boot on crimp head provides abrasion protection
- Audible “pop-off” valve indicates crimp completion

C1. Wiring Duct

- Tool provided with two, NiCd rechargeable batteries and battery charger to allow for continuous operation
- High productivity, up to 35 crimps on 500 kcmil copper lugs and splices on a single battery charge

C2. Surface Raceway

- Eight second crimp cycle time provides quick terminations, saves time

C3. Abrasion Protection



C4. Cable Management

D1. Terminals

D2. Power Connectors

D3. Grounding Connectors

E1. Labeling Systems

E2. Labels

E3. Pre-Printed & Write-On Markers

E4. Permanent Identification

E5. Lockout/Tagout & Safety Solutions

F. Index

- Battery charger charges expended batteries completely in 25 minutes
- Batteries include LED battery charge indicators for visual indication of current battery charge
- Battery charger includes battery reconditioner feature which prevents battery memory build-up and provides over 1,000 battery recharge cycles resulting in long life
- Uses color-coded crimping dies to provide easy matching of crimping die to connector
- Embosses die index number on connector barrels to provide post crimp inspection
- Dies installed using spring loaded die retention pins, no need for tools
- Crimp head rotates 180 degrees to provide versatility for use in restricted spaces

Part Number	Part Description	Std. Pkg. Qty.
CT-2940	<p>Terminates <i>PANDUIT® PAN-LUG™</i> Compression Connectors:</p> <ul style="list-style-type: none"> • Copper compression lugs and splices for #8 AWG – 1000 kcmil code conductor • Copper compression lugs and splices for #8 AWG – 777.7 kcmil flex conductor • Copper compression CTAPF taps for #10 – 3/0 AWG code conductor • Copper compression CTAP taps for #8 – 4/0 AWG code conductor • Copper compression HTCT taps for #14 AWG – 1000 kcmil code conductor and #14 AWG – 777.7 kcmil flex conductor • Aluminum compression lugs and splices for #6 AWG – 1000 kcmil code conductor • Aluminum compression HTAP taps for #14 AWG – 500 kcmil code conductor • <i>PANDUIT® PAN-TERM®</i> Tubular Terminals for #8 AWG – 250 kcmil code conductor <p>Specifications: Output: 15 tons Jaw opening: 2" Weight: 24.25 lbs. with battery Length: 21" Height: 10.5" Width: 3.75" Warranty: 5 years tool, 1 year on batteries</p> <p>CT-2940 includes:</p> <ul style="list-style-type: none"> • Tool • Two CT-BC25, 14.4 VDC rechargeable batteries with LED display • One CT-CHR25 battery charger • Shoulder strap • Plastic case for storage of crimping dies • Plastic tool case with storage for batteries, charger, shoulder strap and crimping die storage case 	1

Uses CD-920 and CD-930 color-coded crimping dies with CD-940-DA die adapter. Uses CD-940 color-coded crimping dies. Dies and die adapter must be purchased separately, see pages D3.46, D3.47. For battery charger and battery accessories, see page D3.51.

Die Type, Remote Hydraulic, 14 Ton, Crimp Head

- Develops 14 tons of crimping force when used with 10,000 psi hydraulic pump and hose, crimps copper compression lugs and splices up to 750 kcmil
- Incorporates Parker type quick-connect fittings to ease installation and save time
- High quality, durable tool construction provides long-term dependability
- Provides UL Listed and CSA Certified connections on *PANDUIT® PAN-LUG™* Copper and Aluminum Lugs and Splices and Copper Taps
- Open “C-Head” design allows easy loading of crimping dies and connectors, saves time
- Uses color-coded crimping dies to provide easy matching of crimping die to connector
- Embosses die index number on connector barrels for post crimp inspection
- Dies installed using spring loaded die retention pins, no need for tools
- Cast in handle allows crimp head to be mounted in a bench vice



Part Number	Part Description	Std. Pkg. Qty.
CT-930CH	<p>Terminates <i>PANDUIT® PAN-LUG™</i> Compression Connectors:</p> <ul style="list-style-type: none"> • Copper compression lugs and splices for #8 AWG – 750 kcmil code conductor • Copper compression lugs and splices for #8 AWG – 600 kcmil flex conductor • Copper compression CTAPF taps for #10 – 3/0 AWG code conductor • Copper compression CTAP taps for #8 – 4/0 AWG code conductor • Copper compression HTCT taps for #14 AWG – 250 kcmil code conductor, #14 – 4/0 AWG flex conductor • Aluminum compression lugs and splices for #6 AWG – 600 kcmil code conductor • Aluminum compression HTAPs for #14 AWG – 500 kcmil code conductor • <i>PANDUIT® PAN-TERM®</i> Tubular Terminals for #8 AWG – 250 kcmil code conductor <p>Use with <i>PANDUIT</i> CT-901 hydraulic pump and CT-900HPH 10' hydraulic hose.*</p> <p>Specifications: Output: 14 tons Jaw opening: 1.65" Weight: 11 lbs. Length: 12 1/4" Height: 5" Width: 3" Warranty: 5 years</p> <p>CT-930CH includes: • Tool • Steel tool case • Supplied with female Parker type quick-connect fitting assembled to tool</p>	1

Uses CD-920 and CD-930 color-coded crimping dies. Dies must be purchased separately, see page D3.46.
 *CT-901RCH remote control handle available, offering one hand operation of crimp head with *PANDUIT* CT-901HP hydraulic pump and CT-900HPH hose, sold separately, see page D3.43. CG-920 crimp force measurement gauge available, sold separately, see page D3.51.

A.
System
Overview

B1.
Cable Ties

B2.
Cable
Accessories

B3.
Stainless
Steel Ties

C1.
Wiring
Duct

C2.
Surface
Raceway

C3.
Abrasion
Protection

C4.
Cable
Management

D1.
Terminals

D2.
Power
Connectors

D3.
Grounding
Connectors

E1.
Labeling
Systems

E2.
Labels

E3.
Pre-Printed
& Write-On
Markers

E4.
Permanent
Identification

E5.
Lockout/
Tagout
& Safety
Solutions

F.
Index

A.
System
Overview

Die Type, Remote Hydraulic, 15 Ton, Crimp Head

B1.
Cable Ties

- Develops 15 tons of crimping force when used with 10,000 psi hydraulic pump and hose, crimps copper compression lugs and splices up to 1,000 kcmil

- Open “C-Head” design allows easy loading of crimping dies and connectors, saves time

B2.
Cable
Accessories

- Incorporates Parker type quick-connect fittings to ease installation and save time
- High quality, durable tool construction provides long-term dependability

- Uses color-coded crimping dies to provide easy matching of crimping die to connector

B3.
Stainless
Steel Ties

- Provides UL Listed and CSA Certified connections on *PANDUIT® PAN-LUG™* Copper and Aluminum Lugs and Splices and Copper Taps

- Embosses die index number on connector barrels for post crimp inspection
- Dies installed using spring loaded die retention pins, no need for tools
- Cast in handle allows crimp head to be mounted in a bench vice

C1.
Wiring
Duct



C2.
Surface
Raceway

C3.
Abrasion
Protection

C4.
Cable
Management

D1.
Terminals

D2.
Power
Connectors

D3.
Grounding
Connectors

E1.
Labeling
Systems

E2.
Labels

E3.
Pre-Printed
& Write-On
Markers

E4.
Permanent
Identification

E5.
Lockout/
Tagout/
& Safety
Solutions

F.
Index

Part Number	Part Description	Std. Pkg. Qty.
CT-940CH	<p>Terminates <i>PANDUIT® PAN-LUG™</i> Compression Connectors:</p> <ul style="list-style-type: none"> • Copper compression lugs and splices for #8 AWG – 1000 kcmil code conductor • Copper compression lugs and splices for #8 AWG – 777.7 kcmil flex conductor • Copper compression CTAPF taps for #10 – 3/0 AWG code conductor • Copper compression CTAP taps for #8 – 4/0 AWG code conductor • Copper compression HTCT taps for #14 AWG – 1000 kcmil code conductor and #14 AWG – 777.7 kcmil flex conductor • Aluminum compression lugs and splices for #6 AWG – 1000 kcmil code conductor • Aluminum compression HTAP taps for #14 AWG – 500 kcmil code conductor • <i>PANDUIT® PAN-TERM®</i> Tubular Terminals for #8 AWG – 250 kcmil code conductor <p>Use with <i>PANDUIT</i> CT-901 hydraulic pump and CT-900HPH 10' hydraulic hose.*</p> <p>Specifications: Output: 15 tons</p> <p>Jaw opening: 2" Weight: 14.5 lbs. Length: 14.5" Height: 4.1" Width: 2.5" Warranty: 5 years</p> <p>CT-940CH includes:</p> <ul style="list-style-type: none"> • Tool • Steel tool case • Supplied with female Parker type quick-connect fitting assembled to tool 	1

Uses CD-920 and CD-930 color-coded crimping dies with CD-940-DA die adapter. Uses color-coded CD-940 crimping dies. Crimping dies and die adapter must be purchased separately, see pages D3.46 and D3.47. CG-940 crimp force measurement gauge available, sold separately, see page D3.51.

*CT-901RCH remote control handle available, offering one hand operation of crimp head with *PANDUIT* CT-901HP hydraulic pump and CT-900HPH hose, sold separately, see page D3.43.

Hydraulic Pump and Accessories, Electric, 10,000 PSI

- Develops 10,000 psi of hydraulic pressure
- Easy to operate using manual switch or remote pendant supplied; or optional CT-901RFS foot switch or CT-901RCH remote controlled handle
- Factory set relief valve, pump stops when crimp is complete
- Convenient 120 VAC operation
- Incorporates Parker type quick-connect fittings to ease installation and save time
- Versatile, can be used with *PANDUIT* CT-930CH, CT-940CH, or CT-980CH crimp heads



CT-901HP



CT-900HPH



CT-901RCH



CT-901RFS

Part Number	Part Description	Std. Pkg. Qty.
CT-901HP	<p>Hydraulic pump. Develops 10,000 PSI output. Pump shuts off when cycle is complete. Will not release until down switch is activated. Compatible with CT-900HPH hydraulic hose, CT-930CH, CT-940CH, and CT-980CH crimp heads sold separately.*</p> <p>Specifications: Pump output: 10,000 psi Tank capacity: 2.5L incorporates sight gauge for visual inspection of fluid level Fluid type: Aero Shell #4 or equal Motor: 120 VAC 50/50Hz Current: 6.5 Amps Horsepower: 1/2 hp Weight: 34 lbs. Length: 7" Height: 14" Width: 6" Warranty: 5 years</p> <p>CT-901HP pump includes: • On/off pendant switch on 10' electric cord • Three prong A/C plug on 10' electric cord • Supplied with female Parker type quick-connect fitting assembled to pump</p>	1
CT-900HPH	Electrically non-conductive 10' hose compatible with <i>PANDUIT</i> CT-901HP hydraulic pump and CT-930CH, CT-940CH, and CT-980CH crimp heads, supplied pre-filled with hydraulic fluid for fast start up. Supplied with two male Parker type quick-connect fittings. Warranty: 5 years	1
CT-901RCH	Remote control handle provides plastic carrying handle incorporating on/off activation switch that allows operator to hold crimp head and activate CT-901HP hydraulic pump with one hand. Use with <i>PANDUIT</i> remote hydraulic crimp heads CT-930CH, CT-940CH, and CT-980CH. Equipped with 3/8" Parker type quick-connect coupler for attaching crimp heads to <i>PANDUIT</i> CT-900HPH hydraulic hose. Includes a 10', three wire control cable that can be directly connected to the CT-901HP pump. Warranty: 5 years	1
CT-901RFS	Dual electrical foot switch that allows convenient "hands free" operation of the <i>PANDUIT</i> CT-901HP or CT-8250HP electric hydraulic pumps used with <i>PANDUIT</i> remote hydraulic crimp heads. Supplied with 10' electric cord that can be directly connected to <i>PANDUIT</i> hydraulic pumps. Warranty: 5 years	1

Contact *PANDUIT* Customer Service for use in production environments.
 *For information on crimp heads, see pages D3.41, D3.42, and D3.50.

A. System Overview

B1. Cable Ties

B2. Cable Accessories

B3. Stainless Steel Ties

C1. Wiring Duct

C2. Surface Raceway

C3. Abrasion Protection

C4. Cable Management

D1. Terminals

D2. Power Connectors

D3. Grounding Connectors

E1. Labeling Systems

E2. Labels

E3. Pre-Printed & Write-On Markers

E4. Permanent Identification

E5. Lockout/Tagout & Safety Solutions

F. Index

A.
System
Overview

Die Type, Remote Hydraulic, 10.5 Ton, Crimp Head

B1.
Cable Ties

- Low pressure system extends life of crimp head for high volume crimping applications

- Open “C-Head” design allows easy loading of crimping dies and connectors, saves time

B2.
Cable
Accessories

- Develops 10.5 tons of crimping force when used with 7,500 psi hydraulic pump and hose, crimps copper compression lugs and splices up to 250 kcmil

- Uses color-coded crimping dies to provide easy matching of crimping die to connector

B3.
Stainless
Steel Ties

- Incorporates Parker type quick-connect fittings to ease installation and save time

- Embosses die index number on connector barrels for post crimp inspection

- High quality, durable tool construction and low pressure hydraulic requirements provide long-term dependability and tool life

- Dies installed using spring loaded die retention pins, no need for tools

- Provides UL Listed and CSA Certified connections on **PANDUIT® PAN-LUG™** Copper Lugs and Splices

- Cast in handle allows crimp head to be mounted in a bench vice

C1.
Wiring
Duct



C2.
Surface
Raceway

C3.
Abrasion
Protection

C4.
Cable
Management

D1.
Terminals

D2.
Power
Connectors

D3.
Grounding
Connectors

E1.
Labeling
Systems

E2.
Labels

E3.
Pre-Printed
& Write-On
Markers

E4.
Permanent
Identification

E5.
Lockout/
Tagout/
& Safety
Solutions

F.
Index

Part Number	Part Description	Std. Pkg. Qty.
CT-930LPCH	<p>Remote hydraulic crimp head provides UL Listed or Recognized terminations of PANDUIT® PAN-LUG™ Copper Compression Lugs and Splices for #8 AWG – 250 kcmil copper code conductor.</p> <p>Use with PANDUIT CT-8250HP hydraulic pump and CT-900LPHPH 10' hydraulic hose.*</p> <p>Specifications: Output: 10.5 tons Jaw opening: 1.65" Weight: 11 lbs. Length: 12 1/4" Height: 5" Width: 3" Warranty: 5 years</p> <p>CT-930LPCH includes: • Tool • Steel tool case • Supplied with male Parker type quick-connect fitting assembled to tool</p>	1

Uses CD-920 color-coded crimping dies. Dies must be purchased separately, see page D3.46. PG-1 in-line pressure gauge provides visual measurement of hydraulic output pressure, sold separately, see page D3.51.

*For information on hydraulic pump and hose, see page D3.45.

Hydraulic Pump and Accessories, Electric, 7,500 PSI

- Develops 7,500 psi of hydraulic pressure
- Easy to operate using manual switch or remote pendant supplied; or optional CT-901RFS foot switch
- Factory set relief valve, pump stops when crimp is complete
- Convenient 120 VAC operation
- Incorporates Parker type quick-connect fittings to ease installation and save time
- Versatile, can be used with *PANDUIT* CT-930LPCH or CT-980LPCH crimp heads



CT-8250HP



CT-900LPHPH



CT-901RFS

Part Number	Part Description	Std. Pkg. Qty.
CT-8250HP	<p>Hydraulic pump. Develops 7,500 psi output. Pump shuts off when cycle is complete. Will not release until down switch is activated. Compatible with CT-900LPHPH hydraulic hose, CT-930LPCH, and CT-980LPCH crimp heads sold separately.*</p> <p>Specifications: Pump output: 7,500 psi Tank capacity: 2.5L incorporates sight gauge for visual inspection of fluid level Fluid type: Aero Shell #4 or equal Motor: 120 VAC 50/50Hz Current: 6.5 Amps Horsepower: 1/2 hp Warranty: 5 years</p> <p>Weight: 34 lbs. Length: 7" Height: 14" Width: 6"</p> <p>CT-8250HP pump includes: • On/off pendant switch on 10' electric cord • Three prong A/C plug on 10' electric cord • Supplied with male Parker type quick-connect fitting assembled to pump</p>	1
CT-900LPHPH	Electrically non-conductive 10' hose compatible with <i>PANDUIT</i> CT-8250HP hydraulic pump and CT-930LPCH and CT-980LPCH crimp heads, supplied pre-filled with hydraulic fluid for fast start up. Supplied with two female Parker type quick-connect fittings. Warranty: 5 years	1
CT-901RFS	Dual electrical foot switch that allows convenient "hands free" operation of the <i>PANDUIT</i> CT-901HP or CT-8250HP electric hydraulic pumps used with <i>PANDUIT</i> remote hydraulic crimp heads. Supplied with 10' electric cord that can be directly connected to <i>PANDUIT</i> hydraulic pumps. Warranty: 5 years	1

*For more information on crimp heads, see pages D3.44 and D3.50.

PG-1 in-line pressure gauge provides visual measurement of hydraulic output pressure, sold separately, see page D3.51.

A. System Overview

B1. Cable Ties

B2. Cable Accessories

B3. Stainless Steel Ties

C1. Wiring Duct

C2. Surface Raceway

C3. Abrasion Protection

C4. Cable Management

D1. Terminals

D2. Power Connectors

D3. Grounding Connectors

E1. Labeling Systems

E2. Labels

E3. Pre-Printed & Write-On Markers

E4. Permanent Identification

E5. Lockout/Tagout & Safety Solutions

F. Index

A. System Overview

CD-920 Crimping Dies

B1. Cable Ties

- Color-coded for easy matching to color-coding marked on connectors
- Embosses die index number on connector barrels for post crimp inspection

- Part number permanently marked on crimping die for easy identification
- Provides circumferential crimp results in terminations with premium electrical and mechanical performance

B2. Cable Accessories



CD-920

B3. Stainless Steel Ties

C1. Wiring Duct

C2. Surface Raceway



C3. Abrasion Protection

C4. Cable Management

D1. Terminals



CD-930H

D2. Power Connectors

D3. Grounding Connectors

E1. Labeling Systems



E2. Labels

E3. Pre-Printed & Write-On Markers

E4. Permanent Identification



CDM-920

E5. Lockout/Tagout & Safety Solutions

F. Index

Part Number	Used to Install <i>PANDUIT</i> Compression Lug and Splice Sizes				Std. Pkg. Qty.
	Copper Conductor Size Code	Copper Die Color and Die No.	Aluminum Code Size Code	Aluminum Die Color and Die No.	
CD-920-8	#8 AWG	Red P21	—	—	1
CD-920-6	#6 AWG	Blue P24	—	—	1
CD-920-4	#4 AWG	Gray P29	#6 AWG	Gray P29	1
CD-920-2	#2 AWG	Brown P33	—	—	1
CD-920-1	#1 AWG	Green P37	#4 AWG	Green P37	1
CD-920-1/0	1/0 AWG	Pink P42	#2 AWG	Pink P42	1
CD-920-2/0	2/0 AWG	Black P45	#1 AWG	Gold P45	1
CD-920-3/0	3/0 AWG	Orange P50	1/0 AWG	Tan P50	1
CD-920-4/0	4/0 AWG	Purple P54	2/0 AWG	Olive P54	1
CD-920-250	250 kcmil	Yellow P62	3/0 AWG	Ruby P62	1
CD-920-300	300 kcmil	White P66	4/0 AWG	White P66	1
CD-920-350	350 kcmil	Red P71	250 kcmil	Red P71	1
CD-920-400	400 kcmil	Blue P76	300 kcmil	Blue P76	1
CD-920-500	500 kcmil	Brown P87	350 kcmil	Brown P87	1
CD-920-600	600 kcmil	Green P94	400 kcmil	Green P94	1
CD-920-500A	500 kcmil flex, 600 kcmil flex	Pink P99	500 kcmil	Pink P99	1
CD-920-750	750 kcmil	Black P106	600 kcmil	Black P106	1

Part Number	Used to Install <i>PANDUIT</i> Tap Part Numbers				Std. Pkg. Qty.
	Copper Tap	Copper Die Color and Die No.	Aluminum Tap	Aluminum Die Color and No.	
Single Crimp Dies					
CD-920H-8	HTCT8-8-1	Green PH8	—	—	1
CD-920H-6	HTCT6-6-1	Orange PH6	—	—	1
CD-920H-2	HTCT2-2-1	Brown PH2	—	—	1
CD-930H-250	HTCT250-8-1, HTCT250-2-1, HTCT250-250-1	Purple PH25	—	—	1
CD-920-3/0	—	—	HTAP2-8-L	Tan P50	1
CD-920-BG	CTAP4-8-L, CTAP4-6-L, CTAP4-4-L	PBG	—	—	1
CD-920-C	CTAP2-4-Q, CTAP2-2-X	PC	—	—	1
CD-920-D3	CTAP4/0-2-X, CTAP4/0-2/0-X, CTAP4/0-4/0-X	PD3	HTAP3/0-1-Q, HTAP3/0-3/0-Q, HTAP4/0-2-Q, HTAP4/0-3/0-Q, HTAP4/0-4/0-Q	PD3	1
CD-920-O	CTAP2/0-2-X, CTAP2/0-2/0-X	PO	HTAP1-1-Q, HTAP1/0-1-Q, HTAP2/0-1-Q	PO	1

Multi-Crimp Dies

CDM-920-2	CTAPF4-12-C	Brown P33M	—	—	1
CDM-920-1	CTAPF3-12-C	Green P37M	—	—	1
CDM-920-1/0	CTAPF2-12-C	Pink P42M	—	—	1
CDM-920-2/0	CTAPF1-12-C	Black P45M	—	—	1
CDM-920-3/0	CTAPF1/0-12-L	Orange P50M	—	—	1
CDM-920-4/0	CTAPF2/0-12-Q	Purple P54M	—	—	1
CDM-920-250	CTAPF3/0-12-Q	Yellow P62M	—	—	1

See pages D3.52 – D3.90 for connector and tool selection information.

CD-940 Crimping Dies

- Color-coded for easy matching to color-coding marked on connectors
- Embosses die index number on connector barrels for post crimp inspection
- Part number permanently marked on crimping die for easy identification
- Provides circumferential crimp results in terminations with premium electrical and mechanical performance



CD-940



CD-940-DA

Part Number	Used to Install <i>PANDUIT</i> Compression Lug and Splice Sizes				Std. Pkg. Qty.
	Copper Conductor Size	Copper Die Color and Die No.	Aluminum Conductor Size	Aluminum Die Color and Die No.	
CD-940-750	750 kcmil	Black P106	—	—	1
CD-940-800	800 kcmil	Orange P107	—	—	1
CD-940-1000	1000 kcmil	White P125	—	—	1
CD-940-750X	777.7 kcmil flex	Yellow P115	—	—	1
CD-940-750A	—	—	750 kcmil	Red P125	1
CD-940-800A	—	—	800 kcmil	Gray P140	1
CD-940-1000A	—	—	1000 kcmil	Brown P161	1

Part Number	Used to Install <i>PANDUIT</i> Tap Part Numbers				Std. Pkg. Qty.
	Copper Tap	Copper Die Color and Die No.	Aluminum Tap	Aluminum Die Color and Die No.	
CD-940-N	—	—	HTAP500-500-X, HTAP500-4/0-X	PN	1
CD-940H-500	HTCT500-250-1, HTCT500-500-1	Brown PH50	—	—	1
CD-940H-750	HTCT750-4/0-1, HTCT750-750-1, HTCT1000-250-1	Yellow PH75	—	—	1
CD-940H-1000	HTCT1000-1000-1	White PH10	—	—	1

See pages D3.52 – D3.90 for connector and tool selection information.

Part Number	Part Description	Std. Pkg. Qty.
CD-940-DA	Die adapter for use with <i>PANDUIT</i> CT-940CH and CT-2940 crimping tools required for installation of <i>PANDUIT</i> CD-920, CDM-920, and CD-930 crimping dies in these tools.	1

A. System Overview

B1. Cable Ties

B2. Cable Accessories

B3. Stainless Steel Ties

C1. Wiring Duct

C2. Surface Raceway

C3. Abrasion Protection

C4. Cable Management

D1. Terminals

D2. Power Connectors

D3. Grounding Connectors

E1. Labeling Systems

E2. Labels

E3. Pre-Printed & Write-On Markers

E4. Permanent Identification

E5. Lockout/Tagout & Safety Solutions

F. Index

A.
System
Overview

UNI-DIE™ Dieless, Manual Hydraulic, 6.2 Ton, Crimping Tool

B1.
Cable Ties

- Dieless crimping tool design eliminates purchase or lost crimping dies, saves cost

- Provides UL Listed and CSA Certified connections on *PANDUIT® PAN-LUG™* Copper Lugs and Splices

B2.
Cable
Accessories

- Develops 6.2 tons of crimping force with four point indenter system, crimps copper compression lugs and splices up to 750 kcmil

- Provides UL Listed and CSA Certified wire range-taking capability on *PANDUIT® PAN-LUG™* Copper Lugs and Splices, minimizes connector inventory and saves cost

B3.
Stainless
Steel Ties

- Two-stage rapid advance hydraulic system minimizes number of pumps required to complete a crimp

- Flip-top crimp head design allows easy loading of connectors, saves time

- High quality, durable tool construction provides long-term dependability

- Audible “pop-off” valve indicates crimp completion

- Cushioned grips prevent hands from slipping on tool, reduces fatigue

- Crimp head rotates 360 degrees, provides versatility for use in restricted spaces

C1.
Wiring
Duct

- Incorporates aluminum crimp head and fiberglass handles, results in lightweight tool and ease of operation

C2.
Surface
Raceway



C3.
Abrasion
Protection

C4.
Cable
Management

D1.
Terminals

D2.
Power
Connectors

D3.
Grounding
Connectors

E1.
Labeling
Systems

E2.
Labels

E3.
Pre-Printed
& Write-On
Markers

E4.
Permanent
Identification

E5.
Lockout/
Tagout/
& Safety
Solutions

F.
Index

Part Number	Part Description	Std. Pkg. Qty.
CT-980	<p>Manual hydraulic <i>UNI-DIE™</i> Dieless Crimping Tool provides UL Listed or Recognized and CSA Certified terminations of <i>PANDUIT® PAN-LUG™</i> Copper Compression Lugs and Splices for #4 AWG – 750 kcmil copper code conductor.</p> <p>Specifications: Output: 6.2 tons Jaw opening: 1.46" Weight: 10.5 lbs. Length: 13" Height: 12" Width: 3" Handle span: 15" (open), 5.75" (closed) Warranty: 5 years</p> <p>CT-980 includes: • Tool • Plastic tool case</p>	1

CG-980 pressure gauge for measuring tool output force available, sold separately, see page D3.51.

UNI-DIE™ Dieless, Battery Powered Hydraulic, 6.2 Ton, Crimping Tool, 12 VDC

- Dieless crimping tool design eliminates purchase or lost crimping dies, saves cost
- Battery powered, provides fingertip operation
- Self-contained unit, completely portable
- Develops 6.2 tons of crimping force with four point indenter system, crimps copper compression lugs and splices up to 750 kcmil
- Two-stage rapid advance hydraulic system minimizes cycle time
- Ram automatically retracts when crimp cycle is complete
- Tool provided with two, high capacity 12 VDC rechargeable nickel-metal hydride batteries to provide for continuous operation and eliminate "memory" build-up, one hour charge time
- Uses industry standard MAKITA* batteries and charger, industry proven reliability and easy to obtain from local retail sources
- Provides UL Listed and CSA Certified connections on PANDUIT® PAN-LUG™ Copper Lugs and Splices
- Provides UL Listed and CSA Certified wire range-taking capability on PANDUIT® PAN-LUG™ Copper Lugs and Splices, minimizes connector inventory and saves cost
- Flip-top crimp head design allows easy loading of splices, saves time
- Crimp head rotates 360 degrees, provides versatility for use in restricted spaces



Part Number	Part Description	Std. Pkg. Qty.
CT-2981	<p>Battery powered hydraulic UNI-DIE™ Dieless Crimping Tool provides UL Listed or Recognized and CSA Certified terminations of PANDUIT® PAN-LUG™ Copper Compression Lugs and Splices for #4 AWG – 750 kcmil copper code conductor.</p> <p>Specifications: Output: 6.2 tons Jaw opening: 1.46" Weight: 10.8 lbs. with battery Length: 13" Height: 12" Width: 3" Warranty: 3 years</p> <p>CT-2981 includes: • Tool • Two 12 VDC, NiMH rechargeable batteries • One battery charger • Steel tool case with storage for batteries, charger, and crimping dies</p>	1
SS-1	Test solder slugs.	1
SS-1GAGE	Solder slug measurement gauge.	1

CG-980 crimp force measurement gauge available, sold separately, see page D3.51.

*MAKITA is a registered trademark of Makita Corporation.

A.
System
Overview

B1.
Cable Ties

B2.
Cable
Accessories

B3.
Stainless
Steel Ties

C1.
Wiring
Duct

C2.
Surface
Raceway

C3.
Abrasion
Protection

C4.
Cable
Management

D1.
Terminals

D2.
Power
Connectors

D3.
Grounding
Connectors

E1.
Labeling
Systems

E2.
Labels

E3.
Pre-Printed
& Write-On
Markers

E4.
Permanent
Identification

E5.
Lockout/
Tagout
& Safety
Solutions

F.
Index

A. System Overview

UNI-DIE™ Dieless, Remote Hydraulic, 6.2 Ton, Crimp Head

B1. Cable Ties

- Dieless crimping tool design eliminates purchase or lost crimping dies, saves cost
- Develops 6.2 tons of crimping force when used with 10,000 psi hydraulic pump and hose, crimps copper compression lugs and splices up to 750 kcmil

- Provides UL Listed and CSA Certified connections on *PANDUIT® PAN-LUG™* Copper Lugs and Splices
- Provides UL Listed and CSA Certified wire range-taking capability on *PANDUIT® PAN-LUG™* Copper Lugs and Splices, minimizes connector inventory and saves cost

B2. Cable Accessories

- Incorporates Parker type quick-connect fittings to ease installation and save time

- Flip-top crimp head design allows easy loading of splices, saves time

B3. Stainless Steel Ties



C1. Wiring Duct

C2. Surface Raceway

C3. Abrasion Protection

C4. Cable Management

Part Number	Part Description	Std. Pkg. Qty.
CT-980CH	Remote hydraulic <i>UNI-DIE™</i> dieless crimp head provides UL Listed or Recognized and CSA Certified terminations of <i>PANDUIT® PAN-LUG™</i> Copper Compression Lugs and Splices for #4 AWG – 750 kcmil copper code conductor. Use with <i>PANDUIT</i> CT-901HP hydraulic pump and CT-900HPH 10' hydraulic hose.* Specifications: Output: 6.2 tons Jaw opening: 1.46" Weight: 6.5 lbs. Length: 10.5" Height: 5.3" Width: 2.5" Warranty: 5 years CT-980CH includes: • Tool • Steel tool case • Supplied with female Parker type quick-connect fitting assembled to tool	1

*CT-901RCH remote control handle available, offering one hand operation of crimp head with *PANDUIT* CT-901HP hydraulic pump and CT-900HPH hose, sold separately, see page D3.43. CG-980 crimp force measurement gauge available, sold separately, see page D3.51.

D1. Terminals

UNI-DIE™ Dieless, Remote Hydraulic, 4.7 Ton, Crimp Head

D2. Power Connectors

- Low pressure system extends life of crimp head for high volume crimping application

- Incorporates Parker type quick-connect fittings to ease installation and save time

D3. Grounding Connectors

- Dieless crimping tool design eliminates purchase or lost crimping dies, saves cost
- Develops 4.7 tons of crimping force when used with 7,500 psi hydraulic pump and hose, crimps copper compression lugs and splices up to 250 kcmil

- Provides UL Listed and CSA Certified connections on *PANDUIT® PAN-LUG™* Copper Lugs and Splices
- Flip-top crimp head design allows easy loading of splices, saves time

E1. Labeling Systems



E2. Labels

E3. Pre-Printed & Write-On Markers

E4. Permanent Identification

E5. Lockout/Tagout & Safety Solutions

Part Number	Part Description	Std. Pkg. Qty.
CT-980LPCH	Remote hydraulic crimp head provides UL Listed or Recognized and CSA Certified terminations of <i>PANDUIT® PAN-LUG™</i> Copper Compression Lugs and Splices for #4 AWG – 250 kcmil code conductor. Use with <i>PANDUIT</i> CT-8250HP hydraulic pump and CT-900LPHPH 10' hydraulic hose.* Specifications: Output: 4.7 tons Weight: 6.5 lbs. Length: 10.5" with coupler Height: 5.3" Width: 2.5" Warranty: 5 years CT-980LPCH includes: • Tool • Steel tool case • Supplied with male Parker type quick-connect fitting assembled to tool	1

PG-1SC in-line pressure gauge provides visual measurement of hydraulic output pressure, sold separately, see page D3.51.

*For information on hydraulic pump and hose, see page D3.45.

F. Index

Pressure Gauges

- Provide easy visual reading of output force for hydraulic crimping tools
- Factory calibrated to provide accuracy and quality assurance control of crimping tools in the field
- Easy-to-read crimp force tolerance zone for applicable tools marked on gauge
- Blank dies for fixture supplied with test gauge for easy mounting and operation of gauge with crimping tool

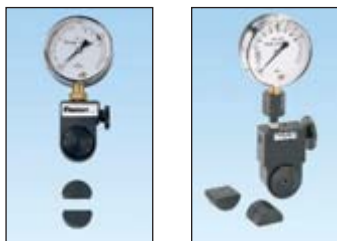

CG-920

CG-940



CG-980



PG-1

Part Number	Part Description	Std. Pkg. Qty.
CG-920	Compression gauge – used to measure crimping force generated by <i>PANDUIT</i> crimping tools: CT-930, CT-930CH, CT-930LPCH, CT-2930 and CT-2931. CG-920 includes: • Pressure gauge • Blank die set • Steel storage case • Warranty: 90 days	1
CG-940	Compression gauge – used to measure output force generated by <i>PANDUIT</i> crimping tools: CT-940CH and CT-2940. CG-940 includes: • Pressure gauge • Blank die set • Steel storage case • Warranty: 90 days	1
CG-980	Compression gauge – used to insure proper compression force for <i>UNI-DIE™</i> Dieless Crimping Tools: CT-980, CT-980CH, CT-2980 and CT-2981. CG-980 includes: • Pressure gauge • Fixture for mounting gauge in crimping tool • Steel storage case • Warranty: 90 days	1
PG-1	In-line pressure gauge provides visual identification of hydraulic output pressure when used with <i>PANDUIT</i> CT-930CH, CT-940CH, and CT-980CH crimp heads, CT-901HP pump and CT-900HPH hose. Includes steel storage case. Warranty: 90 days	1
PG-1SC	In-line pressure gauge provides visual identification of hydraulic output pressure when used with <i>PANDUIT</i> CT-930LPCH and CT-980LPCH crimp heads, CT-8250HP pump and CT-900LPHPH hose. Includes steel storage case. Warranty: 90 days	1

Accessories for Battery Powered Hydraulic Crimping Tools



CT-BC25



CT-NLBC25



CT-CHR25

Part Number	Part Description	Std. Pkg. Qty.
CT-BC25	Rechargeable 14.4 VDC NiCd battery with LED display to monitor remaining power and number of charge cycles. Battery life is approximately 1,000 recharge cycles. Use with <i>PANDUIT</i> battery operated crimping tools: CT-2001, CT-2002, CT-2930, CT-2980 and CT-2940. Warranty: 1 year	1
CT-NLBC25	Rechargeable 14.4 VDC NiCd battery without LED display. Battery life is approximately 1,000 recharge cycles. Use with <i>PANDUIT</i> battery operated crimping tools: CT-2001, CT-2002, CT-2930, CT-2980 and CT-2940. Warranty: 5 years	1
CT-CHR25	Battery charger designed to charge the CT-BC25 and CT-NLBC25 batteries in 25 minutes. Includes battery reconditioning feature to maximize battery life. LED display to visually indicate battery charge status. 120 VAC, 50/60Hz UL Listed. Use with <i>PANDUIT</i> battery powered crimping tools: CT-2001, CT-2002, CT-2930, CT-2980 and CT-2940. Warranty: 5 years	1
C-2001	High impact strength, blow molded plastic case for CT-2001 crimping tool. Includes storage for CT-CHR25 battery charger, two CT-NLBC25 batteries, shoulder strap and crimping dies.	1

A. System Overview

B1. Cable Ties

B2. Cable Accessories

B3. Stainless Steel Ties

C1. Wiring Duct

C2. Surface Raceway

C3. Abrasion Protection

C4. Cable Management

D1. Terminals

D2. Power Connectors

D3. Grounding Connectors

E1. Labeling Systems

E2. Labels

E3. Pre-Printed & Write-On Markers

E4. Permanent Identification

E5. Lockout/Tagout & Safety Solutions

F. Index

A. System Overview

B1. Cable Ties

For use with Copper Conductors

Installation Tooling and Die Selections for: Types LCAS and SCSS

How to read this chart

For LCA6 lug and CT-2001 crimping tool:

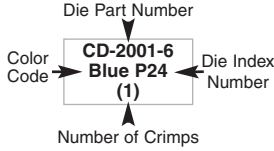

B2. Cable Accessories

B3. Stainless Steel Ties

PANDUIT (See Compression Connector Tools Selection Guide, Pages D3.30 – D3.32)

Thomas and Betts

PANDUIT Part Number	Std. Wire Size	Wire Strip Length (In.)	Die Part Number/Color Code and Die Index Number/(Number of Crimps)							
			CT-1700 ^①	CT-720	CT-920, CT-920CH, CT-930, CT-930CH, CT-2930, CT-930LPCH, CT-2931, CT-2940 ^③ , CT-2920, CT-940CH ^③	Uni-Die™ CT-980, CT-2980, CT-980CH, CT-2981, CT-980LPCH, CT-2950	CT-2001, CT-2002	TBM20S, TBM25S	TBM5	TBM8
LCAS8	#8 AWG	1/2	Red P21 (2)	CD-720-1 Red P21 (1)	CD-920-8 Red P21 (1)	—	CD-2001-8 Red P21 (1)	Red 21 (2)	Red 21 (1)	Red 21 (1)
SCSS8		7/16								
LCAS6	#6 AWG	9/16	Blue P24 (2)	CD-720-1 Blue P24 (1)	CD-920-6 Blue P24 (1)	—	CD-2001-6 Blue P24 (1)	Blue 24 (2)	Blue 24 (1)	Blue 24 (1)
SCSS6		7/16								
LCAS4	#4 AWG	5/8	Gray P29 (2)	CD-720-1 Gray P29 (1)	CD-920-4 Gray P29 (1)	(1)	CD-2001-4 Gray P29 (1)	Gray 29 (2)	Gray 29 (2)	Gray 29 (2)
SCSS4		7/16								
LCAS2	#2 AWG	5/8	Brown P33 (2)	CD-720-1 Brown P33 (1)	CD-920-2 Brown P33 (1)	(1)	CD-2001-2 Brown P33 (1)	Brown 33 (2)	Brown 33 (2)	Brown 33 (2)
SCSS2		9/16								
LCAS1	#1 AWG	11/16	Green P37 (3)	CD-720-2 Green P37 (1)	CD-920-1 Green P37 (1)	(1)	CD-2001-1 Green P37 (1)	—	Green 37 (1)	Green 37 (1)
SCSS1										
LCAS1/0	1/0 AWG	3/4	—	CD-720-2 Pink P42 (1)	CD-920-1/0 Pink P42 (1)	(1)	CD-2001-1/0 Pink P42 (1)	—	Pink 42 (1)	Pink 42 (1)
SCSS1/0		11/16								
LCAS2/0	2/0 AWG	3/4	—	CD-720-2 Black P45 (2)	CD-920-2/0 Black P45 (1)	(1)	CD-2001-2/0 Black P45 (2)	—	Black 45 (2)	Black 45 (2)
SCSS2/0										
LCAS3/0	3/0 AWG	7/8	—	CD-720-2 Orange P50 (2)	CD-920-3/0 Orange P50 (1)	(1)	CD-2001-3/0 Orange P50 (2)	—	Orange 50 (2)	Orange 50 (2)
SCSS3/0		3/4								
LCAS4/0	4/0 AWG	1	—	CD-720-3 Purple P54 (2)	CD-920-4/0 Purple P54 (1)	(1)	CD-2001-4/0 Purple P54 (2)	—	Purple 54 (2)	Purple 54 (2)
SCSS4/0		13/16								
LCAS250	250 kcmil	1-1/8	—	CD-720-3 Yellow P62 (2)	CD-920-250 Yellow P62 (1)	(1)	CD-2001-250 Yellow P62 (2)	—	Yellow 62 (2)	Yellow 62 (2)
SCSS250		1-1/16								

①The CT-1700 crimp die pockets are integrated into the tool frame.

③CD-920 dies can be used with CT-940CH and CT-2940 tools with the CD-940-DA adapter.

E3. Pre-Printed & Write-On Markers

E4. Permanent Identification

E5. Lockout/Tagout & Safety Solutions

F. Index

For use with
Copper
Conductors

Installation Tooling and Die Selections for: Types LCAS and SCSS (continued)

Thomas and Betts				Burndy				Anderson	Penn-Union	Greenlee
TBM12, 13642M	TBM15, TBM15I, TBM15BSCR	TBM8-750M-I, TBM8-750, TBM8-750BSCR, TBM750BSCR ^④	TBM14M, TBM14BSCR, BPLT14BSCR, 13100A	Y2MR, Y1MRTC, Y1MR	MY29	Y35, Y35BH, Y39, Y39BH, Y45, Y46, Y750, Y750-2, Y750BH, Y750BH-2, Y750HS, PAT750, BAT750, BAT35	Y644M, Y644HS, Y644MBH, PAT644, BAT644	VC6	TDY-1	1989
Die Part Number/Color Code and Die Index Number/(Number of Crimps)										
Red 21 (1)	Red 21 (1)	STD (1)	Red 21 (1)	Red (2)	#8 (1)	U8CRT Red 49 (1)	—	—	—	—
Blue 24 (1)	Blue 24 (1)	STD (1)	Blue 24 (1)	Blue (2)	#6 (1)	U5CRT Blue 7 (1)	STD (1)	STD (1)	—	—
Gray 29 (1)	Gray 29 (1)	STD (1)	Gray 29 (1)	Gray (2)	#4 (1)	U4CRT Gray 8 (1)	STD (1)	STD (1)	STD (1)	STD (1)
Brown 33 (1)	Brown 33 (1)	STD (1)	Brown 33 (1)	Brown (2)	#2 (1)	U2CRT Brown 10 (1)	STD (1)	STD (1)	STD (1)	STD (1)
Green 37 (1)	Green 37 (1)	STD (1)	Green 37 (1)	—	#1 (1)	U1CRT Green 11 (1)	STD (1)	STD (1)	STD (1)	STD (1)
Pink 42 (1)	Pink 42H ^② (2)	STD (1)	Pink 42H ^② (2)	—	1/0 (1)	U25RT Pink 12 (1)	STD (1)	STD (1)	STD (1)	STD (1)
Black 45 (1)	Black 45 (1)	STD (1)	Black 45 (1)	—	2/0 (1)	U26RT Black 13 (1)	STD (1)	STD (1)	STD (1)	STD (1)
Orange 50 (1)	Orange 50 (1)	STD (1)	Orange 50 (1)	—	3/0 (1)	U27RT Orange 14 (1)	STD (1)	STD (1)	STD (1)	STD (1)
Purple 54 (1)	Purple 54H ^② (2)	STD (1)	Purple 54H ^② (2)	—	4/0 (1)	U28RT Purple 15 (1)	STD (1)	STD (1)	STD (1)	STD (1)
Yellow 62 (1)	Yellow 62 (1)	STD (1)	Yellow 62 (1)	—	250 (1)	U29RT Yellow 16 (1)	STD (1)	STD (2)	—	Yellow (2)

②Half width dies.

④Minimum size: #4 AWG lugs and splices.

A.
System
Overview

B1.
Cable
Ties

B2.
Cable
Accessories

B3.
Stainless
Steel Ties

C1.
Wiring
Duct

C2.
Surface
Raceway

C3.
Abrasion
Protection

C4.
Cable
Management

D1.
Terminals

D2.
Power
Connectors

D3.
Grounding
Connectors

E1.
Labeling
Systems

E2.
Labels

E3.
Pre-Printed
& Write-On
Markers

E4.
Permanent
Identification

E5.
Lockout/
Tagout
& Safety
Solutions

F.
Index

A. System Overview

B1. Cable Ties

B2. Cable Accessories

B3. Stainless Steel Ties

C1. Wiring Duct

C2. Surface Raceway

C3. Abrasion Protection

C4. Cable Management

D1. Terminals

D2. Power Connectors

D3. Grounding Connectors

E1. Labeling Systems

E2. Labels

E3. Pre-Printed & Write-On Markers

E4. Permanent Identification

E5. Lockout/Tagout & Safety Solutions

F. Index

For use with Copper Conductors

Installation Tooling and Die Selections for: Types LCA, LCA^N, LCD, LCD^N and SCS

How to read this chart

For LCA6 lug and CT-2001 crimping tool:

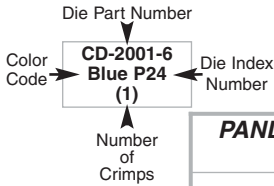

PANDUIT (See Compression Connector Tools Selection Guide, Pages D3.30 – D3.32)

Thomas and Betts

PANDUIT Part Number	L = Lug S = Splice	Std. Wire Size	Wire Strip Length (In.)	PANDUIT (See Compression Connector Tools Selection Guide, Pages D3.30 – D3.32)						Thomas and Betts			
				CT-1570	CT-1701 ^①	CT-1700 ^①	CT-720	CT-920, CT-920CH, CT-930, CT-930CH, CT-930LPCH ^⑤ , CT-2920, CT-2930, CT-2931, CT-940CH ^③ , CT-2940 ^③	UNI-DIE™ Dieless CT-980, CT-2980, CT-980LPCH ^⑥ , CT-980CH, CT-2950 ^⑤ , CT-2981 Extended Wire Range	CT-2001, CT-2002	TBM20S, TBM25S	TBM5, TBM8	TBM12, 13642M
Die Part Number/Color Code and Die Index Number/(Number of Crimps)													
LCA10 LCD10		#14 – #10 AWG STR, #12 – #10 AWG SOL	7/16	12-10 (1)	P10 (1)	—	—	—	—	—	—	—	
LCA8 LCA ^N 8 LCD8 LCD ^N 8		#8 AWG	5/8	—	—	Red P21 (2)	CD-720-1 Red P21 (1)	CD-920-8 Red P21 (1)	—	CD-2001-8 Red P21 (1)	Red 21 (2)	Red 21 (1)	Red 21 (1)
SCS8			11/16										
LCA6 LCA ^N 6 LCD6 LCD ^N 6		#6 AWG	7/8	—	—	Blue P24 (2)	CD-720-1 Blue P24 (1)	CD-920-6 Blue P24 (1)	—	CD-2001-6 Blue P24 (1)	Blue 24 (2)	Blue 24 (1)	Blue 24 (1)
SCS6			13/16										
LCA4 LCA ^N 4 LCD4 LCD ^N 4		#4 – #3 AWG STR, #2 AWG SOL	7/8	—	—	Gray P29 (2)	CD-720-1 Gray P29 (1)	CD-920-4 Gray P29 (1)	#4 – #2 AWG STR Only (1)	CD-2001-4 Gray P29 (1)	Gray 29 (2)	Gray 29 (1)	Gray 29 (1)
SCS4			13/16										
LCA2 LCA ^N 2 ^② LCD2 LCD ^N 2		#2 AWG	15/16	—	—	Brown P33 (2)	CD-720-1 Brown P33 (1)	CD-920-2 Brown P33 (1)	#6 – #2 AWG (1)	CD-2001-2 Brown P33 (1)	Brown 33 (2)	Brown 33 (1)	Brown 33 (1)
SCS2			7/8										
LCA1 LCA ^N 1 LCD1 LCD ^N 1		#1 AWG	15/16	—	—	Green P37 (3)	CD-720-2 Green P37 (1)	CD-920-1 Green P37 (1)	#6 – #1 AWG (1)	CD-2001-1 Green P37 (1)	—	Green 37 (1)	Green 37 (1)
SCS1			7/8										
LCA1/0 LCA ^N 1/0 LCD1/0 LCD ^N 1/0		1/0 AWG	1	—	—	—	CD-720-2 Pink P42 (1)	CD-920-1/0 Pink P42 (1)	#6 – 1/0 AWG (1)	CD-2001-1/0 Pink P42 (1)	—	Pink 42 (1)	Pink 42 (1)
SCS1/0			7/8										
LCA2/0 LCA ^N 2/0 LCD2/0 LCD ^N 2/0		2/0 AWG	1-1/16	—	—	—	CD-720-2 Black P45 (2)	CD-920-2/0 Black P45 (2)	#4 – 2/0 AWG (1)	CD-2001-2/0 Black P45 (2)	—	Black 45 (2)	Black 45 (1)
SCS2/0			15/16										
LCA3/0 LCA ^N 3/0 LCD3/0 LCD ^N 3/0		3/0 AWG	1-3/16	—	—	—	CD-720-2 Orange P50 (2)	CD-920-3/0 Orange P50 (2)	#2 – 3/0 AWG (1)	CD-2001-3/0 Orange P50 (2)	—	Orange 50 (2)	Orange 50 (1)
SCS3/0			1										

①The CT-1700 and CT-1701 crimp die pockets are integrated into the tool frame.

③CD-920 dies can be used with CT-940CH and CT-2940 tools with CD-940-DA adapter.

⑤Maximum size: 500 kcmil lugs and 250 kcmil splices.

⑥Maximum size: 250 kcmil lugs and splices. No extended wire range.

For use with
Copper
Conductors

Installation Tooling and Die Selections for: Types LCA, LCA, LCD, LCDN and SCS (continued)

A.
System
Overview

B1.
Cable
Ties

B2.
Cable
Accessories

B3.
Stainless
Steel Ties

C1.
Wiring
Duct

C2.
Surface
Raceway

C3.
Abrasion
Protection

C4.
Cable
Management

D1.
Terminals

D2.
Power
Connectors

D3.
Grounding
Connectors

E1.
Labeling
Systems

E2.
Labels

E3.
Pre-Printed
& Write-On
Markers

E4.
Permanent
Identification

E5.
Lockout/
Tagout
& Safety
Solutions

F.
Index

Thomas and Betts			Burndy					Anderson	Penn-Union	Greenlee
TBM15, TBM15I, TBM15BSCR	TBM8-750M-1, TBM8-750, TBM8-750BSCR, TBM750BSCR®	TBM14M, TBM14BSCR, BPLT14BSCR, 13100A	Y2MR, Y1MR, Y1MRTC	MY29	BAT35, Y39BH, Y35BH, Y750, Y750BH, Y750-2, Y750HS, Y750BH-2, Y39, PAT750, Y35, BAT750	Y45 ^⑦ , Y46 ^⑦	Y644M, Y644HS, PAT644, BAT644, Y644MBH	VC6	TDY-1	1989
Die Part Number/Color Code and Die Index Number/(Number of Crimps)										
—	—	—	—	—	—	—	—	—	—	—
Red 21 (1)	STD (1)	Red 21 (1)	Red 49 (1)	#8 (1)	U8CRT Red 49 (1)	U8CRT Red 49 (1)	—	—	—	—
Blue 24 (1)	STD (1)	Blue 24 (1)	Blue 7 (2)	#6 (1)	U5CRT Blue 7 (1)	U5CRT Blue 7 (1)	STD (1)	STD (1)	—	—
Gray 29 (1)	STD (1)	Gray 29 (1)	Gray 8 (2)	#4 (1)	U4CRT Gray 8 (1)	U4CRT Gray 8 (1)	STD (1)	STD (1)	—	STD (1)
Brown 33 (1)	STD (1)	Brown 33 (1)	Brown 10 (2)	#2 (1)	U2CRT Brown 9 [solid]/ Brown 10 [stranded] (1)	U2CRT Brown 9 [solid]/ Brown 10 [stranded] (1)	STD (1)	STD (1)	STD (1)	STD (1)
Green 37 (1)	STD (1)	Green 37 (1)	—	#1 (1)	U1CRT Green 11 (1)	U1CRT Green 11 (1)	STD (1)	STD (1)	STD (1)	STD (1)
Pink 42H [®] (2)	STD (1)	Pink 42H [®] (2)	—	1/0 (1)	U25RT Pink 12 (1)	U25RT Pink 12 (1)	STD (1)	STD (1)	STD (1)	STD (1)
Black 45 (1)	STD (1)	Black 45 (1)	—	2/0 (1)	U26RT Black 13 (1)	U26RT Black 13 (1)	STD (1)	STD (1)	STD (1)	STD (1)
Orange 50 (1)	STD (1)	Orange 50 (1)	—	3/0 (1)	U27RT Orange 14 (1)	U27RT Orange 14 (1)	STD (1)	STD (1)	STD (1)	STD (1)

®Half width dies.

⑦Requires U die adapter.

®Minimum size: #4 AWG lugs and splices.

Chart continues on pages D3.56 – D3.57

**For use with
Copper
Conductors**

Installation Tooling and Die Selections for: Types LCA, LCA, LCD, LCDN and SCS (continued)

PANDUIT Part Number	Std. Wire Size	Wire Strip Length (In.)	PANDUIT (See Compression Connector Tools Selection Guide, Pages D3.30 – D3.32)				Thomas and Betts		
			CT-720	CT-920, CT-920CH, CT-930, CT-930CH, CT-930LPCH®, CT-2920, CT-2930, CT-2931, CT-940CH®, CT-2940®	CT-980, CT-2980, CT-980LPCH®, CT-980CH, CT-2950®, CT-2981 Extended Wire Range	CT-2001, CT-2002	TBM5	TBM8	TBM12, 13642M
L = Lug S = Splice			Die Part Number/Color Code and Die Index Number/(Number of Crimps)						
LCA4/0 LCAN4/0 LCD4/0 LCDN4/0 SCS4/0	4/0 AWG	1-1/4 1	CD-720-3 Purple P54 (2)	CD-920-4/0 Purple P54 (2)	1 – 4/0 AWG (1)	CD-2001-4/0 Purple P54 (2)	Purple 54 (2)	Purple 54 (2)	Purple 54 (1)
LCA250 LCAN250 LCD250 LCDN250 SCS250	250 kcmil	1-5/16 1-1/16	CD-720-3 Yellow P62 (2)	CD-920-250 Yellow P62 (2)	1/0 AWG – 250 kcmil (2)	CD-2001-250 Yellow P62 (2)	Yellow 62 (2)	Yellow 62 (2)	Yellow 62 (1)
LCA300 LCAN300 LCD300 LCDN300 SCS300	300 kcmil	1-1/2 1-1/16	CD-720-4 White P66 (2)	CD-920-300 White P66 (2)	2/0 AWG – 300 kcmil (2)	CD-2001-300 White P66 (2)	—	White 66 (2)	White 66H ^② (1)
LCA350 LCAN350 LCD350 LCDN350 SCS350	350 kcmil	1-1/2 1-1/8	CD-720-5 Red P71 (2)	CD-920-350 Red P71 (2)	3/0 AWG – 350 kcmil (2)	CD-2001-350 Red P71 (2)	—	Red 71 (2)	Red 71H ^② (2)
LCA400 LCAN400 LCD400 LCDN400 SCS400	400 kcmil	1-9/16 1-3/16	CD-720-6 Blue P76 (2)	CD-920-400 Blue P76 (2)	4/0 AWG – 400 kcmil (2)	CD-2001-400 Blue P76 (3)	—	Blue 76 (2)	Blue 76H ^② (2)
LCA500 LCAN500 LCD500 LCDN500 SCS500	500 kcmil	1-13/16 1-3/8	CD-720-7 Brown P87 (2)	CD-920-500 Brown P87 (2)	4/0 AWG – 500 kcmil (2)	CD-2001-500 Brown P87 (3)	—	Brown 87 (2)	Brown 87H ^② (2)
LCA600 LCAN600 LCD600 LCDN600 SCS600	600 kcmil	1-13/16 1-3/8	—	CD-920-600 Green P94 (2)	250 – 600 kcmil (2)	—	—	—	Green 94H ^② (2)
LCA750 LCAN750 LCD750 LCDN750 SCS750	750 kcmil	1-15/16 1-5/8	—	CD-920-750 CD-940-750 ^④ Black P106 (2)	500 – 750 kcmil (2)	—	—	—	Black 106H ^② (2)
LCD1000 SCS1000	1000 kcmil	1-15/16 1-7/8	—	CD-940-1000 ^④ White P125 (4)	—	—	—	—	—

②Half width dies.
 ③CD-920 dies can be used with CT-940CH and CT-2940 tools with CD-940-DA adapter.
 ④CD-940 dies to be used exclusively with CT-940CH and CT-2940 tools.
 ⑤Maximum size: 500 kcmil lugs and 250 kcmil splices.
 ⑥Maximum size: 250 kcmil lugs and splices. No extended wire range.

**For use with
Copper
Conductors**

Installation Tooling and Die Selections for: Types LCA, LCA, LCD, LCDN and SCS (continued)

Thomas and Betts			Burndy					Anderson	Penn-Union	Greenlee
TBM15, TBM15I, TBM15BSCR	TBM8-750M-1, TBM8-750, TBM8-750BSCR, TBM750BSCR ^③	TBM14M, TBM14BSCR, BPLT14BSCR, 13100A	Y2MR, Y1MR, Y1MRTC	MY29	BAT35, Y35BH, Y750, Y39BH, Y750BH, Y750-2, Y750HS, Y750BH-2, Y39, PAT750, Y35, BAT750	Y45 ^② , Y46 ^②	Y644M, Y644HS, PAT644, BAT644, Y644MBH	VC6	TDY-1	1989
Die Part Number/Color Code and Die Index Number/(Number of Crimps)										
Purple 54H ^② (2)	STD (1)	Purple 54H ^② (2)	—	4/0 (1)	U28RT Purple 15 (1)	U28RT Purple 15 (1)	STD (1)	STD (1)	STD (1)	STD (1)
Yellow 62 (1)	STD (1)	Yellow 62 (1)	—	250 (1)	U29RT Yellow 16 (1)	U29RT Yellow 16 (1)	STD (1)	STD (2)	STD (1)	STD (1)
White 66 (1)	STD (1)	White 66 (1)	—	—	U30RT White 17 (2)	U30RT White 17 (2)	STD (1)	STD (2)	STD (1)	STD (1)
Red 71H ^② (2)	STD (1)	Red 71H ^② (2)	—	—	U31RT Red 18 (2)	U31RT Red 18 (2)	STD (1)	STD (2)	STD (1)	STD (1)
Blue 76H ^② (2)	STD (1)	Blue 76 (1)	—	—	U32RT Blue 19 (2)	U32RT Blue 19 (2)	STD (1)	STD (2)	STD (1)	STD (1)
Brown 87H ^② (2)	STD (1)	Brown 87H ^② (2)	—	—	U34RT Brown 20 (2)	U34RT Brown 20 (2)	STD (1)	STD (2)	STD (1)	STD (1)
Green 94H ^② (2)	STD (1)	Green 94H ^② (2)	—	—	U36RT Green 22 (2)	U36RT Green 22 (2)	STD (1)	—	STD (1)	—
Black 106H ^② (2)	STD (1)	Black 106H ^② (2)	—	—	U39RT Black 24 (3)	U39RT Black 24 (3)	STD (1)	—	STD (1)	—
125H ^② (2)	—	125H ^② (2)	—	—	—	S44RT White 27 (4)	—	—	—	—

②Half width dies.

⑦Requires U die adapter.

③Minimum size: #4 AWG lugs and splices.

A.
System
Overview

B1.
Cable Ties

B2.
Cable
Accessories

B3.
Stainless
Steel Ties

C1.
Wiring
Duct

C2.
Surface
Raceway

C3.
Abrasion
Protection

C4.
Cable
Management

D1.
Terminals

D2.
Power
Connectors

D3.
Grounding
Connectors

E1.
Labeling
Systems

E2.
Labels

E3.
Pre-Printed
& Write-On
Markers

E4.
Permanent
Identification

E5.
Lockout/
Tagout
& Safety
Solutions

F.
Index

A. System Overview

B1. Cable Ties

For use with Copper Conductors

Installation Tooling and Die Selections for: Types LCB, LCBN, LCC, LCCN and SCL

How to read this chart
For LCB6 lug and CT-2001 crimping tool:

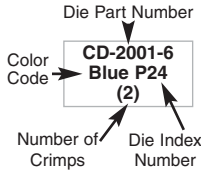

PANDUIT (See Compression Connector Tools Selection Guide, Pages D3.30 – D3.32)

Thomas and Betts

PANDUIT Part Number	Std. Wire Size	Wire Strip Length (In.)	PANDUIT (See Compression Connector Tools Selection Guide, Pages D3.30 – D3.32)										Thomas and Betts					
			CT-1570	CT-1701 ^①	CT-1700 ^①	CT-720	CT-920, CT-920CH, CT-930, CT-930CH, CT-2920, CT-2930, CT-2931, CT-930LPCH ^⑥ , CT-940CH ^③ , CT-2940 ^③	Uni-DIE™ CT-980, CT-980CH, CT-2950 ^⑤ , CT-2980, CT-2981, CT-980LPCH ^⑥ Extended Wire Range	CT-2001, CT-2002	TBM20S, TBM25S	TBM5	TBM8	TBM12, 13642M					
L = Lug S = Splice			Die Part Number/Color Code and Die Index Number/(Number of Crimps)															
LCB10 LCC10	#14 – #10 AWG STR, #12 – #10 AWG SOL	9/16	12-10 (2)	P10 (2)	—	—	—	—	—	—	—	—	—	—	—	—	—	—
LCB8 LCBN8 LCC8 LCCN8	#8 AWG	3/4	—	—	Red P21 (3)	CD-720-1 Red P21 (2)	CD-920-8 Red P21 (1)	—	CD-2001-8 Red P21 (2)	Red 21 (3)	Red 21 (1)	Red 21 (1)	Red 21 (1)	—	—	—	—	—
SCL8		1-1/16	—	—	—	—	—	—	—	—	—	—	—	—	—	—	—	—
LCB6 LCBN6 LCC6 LCCN6	#6 AWG	1-1/8	—	—	Blue P24 (3)	CD-720-1 Blue P24 (2)	CD-920-6 Blue P24 (1)	—	CD-2001-6 Blue P24 (2)	Blue 24 (3)	Blue 24 (1)	Blue 24 (1)	Blue 24 (1)	—	—	—	—	—
SCL6		—	—	—	—	—	—	—	—	—	—	—	—	—	—	—	—	—
LCB4 LCBN4 LCC4 LCCN4	#4 – #3 AWG STR, #2 AWG SOL	1-1/8	—	—	Gray P29 (3)	CD-720-1 Gray P29 (2)	CD-920-4 Gray P29 (1)	#4 – #2 AWG #2 AWG SOL Only (1)	CD-2001-4 Gray P29 (2)	Gray 29 (3)	Gray 29 (1)	Gray 29 (1)	Gray 29 (1)	—	—	—	—	—
SCL4		—	—	—	—	—	—	—	—	—	—	—	—	—	—	—	—	—
LCB2 LCBN2 LCC2 LCCN2	#2 AWG	1-1/4	—	—	Brown P33 (3)	CD-720-1 Brown P33 (2)	CD-920-2 Brown P33 (1)	#6 – #2 AWG (1)	CD-2001-2 Brown P33 (2)	Brown 33 (3)	Brown 33 (1)	Brown 33 (1)	Brown 33 (1)	—	—	—	—	—
SCL2		—	—	—	—	—	—	—	—	—	—	—	—	—	—	—	—	—
LCB1 LCBN1 LCC1 LCCN1	#1 AWG	1-7/16	—	—	Green P37 (4)	CD-720-2 Green P37 (2)	CD-920-1 Green P37 (1)	#6 – #1 AWG (1)	CD-2001-1 Green P37 (2)	—	Green 37 (1)	Green 37 (1)	Green 37 (1)	—	—	—	—	—
SCL1		1-3/8	—	—	—	—	—	—	—	—	—	—	—	—	—	—	—	—
LCB1/0 LCBN1/0 LCC1/0 LCCN1/0	1/0 AWG	1-1/2	—	—	—	CD-720-2 Pink P42 (2)	CD-920-1/0 Pink P42 (2)	#6 – 1/0 AWG (2)	CD-2001-1/0 Pink P42 (2)	—	Pink 42 (2)	Pink 42 (2)	Pink 42 (2)	—	—	—	—	—
SCL1/0		1-3/8	—	—	—	—	—	—	—	—	—	—	—	—	—	—	—	—
LCB2/0 LCBN2/0 LCC2/0 LCCN2/0	2/0 AWG	1-9/16	—	—	—	CD-720-2 Black P45 (3)	CD-920-2/0 Black P45 (3)	#4 – 2/0 AWG (2)	CD-2001-2/0 Black P45 (3)	—	Black 45 (3)	Black 45 (3)	Black 45 (2)	—	—	—	—	—
SCL2/0		1-1/2	—	—	—	—	—	—	—	—	—	—	—	—	—	—	—	—
LCB3/0 LCBN3/0 LCC3/0 LCCN3/0	3/0 AWG	1-9/16	—	—	—	CD-720-2 Orange P50 (3)	CD-920-3/0 Orange P50 (3)	#2 – 3/0 AWG (2)	CD-2001-3/0 Orange P50 (3)	—	Orange 50 (3)	Orange 50 (3)	Orange 50 (2)	—	—	—	—	—
SCL3/0		1-1/2	—	—	—	—	—	—	—	—	—	—	—	—	—	—	—	—
LCB4/0 LCBN4/0 LCC4/0 LCCN4/0	4/0 AWG	1-5/8	—	—	—	CD-720-3 Purple P54 (3)	CD-920-4/0 Purple P54 (3)	#1 – 4/0 AWG (2)	CD-2001-4/0 Purple P54 (3)	—	Purple 54 (3)	Purple 54 (3)	Purple 54 (2)	—	—	—	—	—
SCL4/0		—	—	—	—	—	—	—	—	—	—	—	—	—	—	—	—	—
LCB250 LCBN250 LCC250 LCCN250	250 kcmil	1-11/16	—	—	—	CD-720-3 Yellow P62 (4)	CD-920-250 Yellow P62 (3)	1/0 AWG – 250 kcmil (3)	CD-2001-250 Yellow P62 (3)	—	Yellow 62 (4)	Yellow 62 (4)	Yellow 62 (2)	—	—	—	—	—
SCL250		1-5/8	—	—	—	—	—	—	—	—	—	—	—	—	—	—	—	—

①The CT-1700 and CT-1701 crimp die pockets are integrated into the tool frame.
 ③CD-920 dies can be used with CT-940CH and CT-2940 tools with CD-940-DA adapter.
 ⑤Maximum size: 500 kcmil lugs and 250 kcmil splices.
 ⑥Maximum size: 250 kcmil lugs and splices. No extended wire range.

For use with
Copper
Conductors

Installation Tooling and Die Selections for: Types LCB, LCBN, LCC, LCCN and SCL (continued)

Thomas and Betts			Burndy					Anderson	Penn-Union	Greenlee
TBM15, TBM15I, TBM15BSCR	TBM8-750M-1, TBM8-750, TBM750BSCR [®] , TBM8-750BSCR	TBM14M, TBM14BSCR, BPLT14BSCR, 13100A	Y2MR, Y1MR, Y1MRTC	MY29	Y35, Y35BH, Y39, Y39BH, Y750, Y750-2, Y750BH, Y750HS, Y750BH-2, PAT750, BAT750, BAT35	Y45 ^⑦ , Y46 ^⑦	Y644M, Y644HS, Y644MBH, PAT644, BAT644	VC6	TDY-1	1989
Die Part Number/Color Code and Die Index Number/(Number of Crimps)										
—	—	—	—	—	—	—	—	—	—	—
Red 21 (1)	STD (1)	Red 21 (1)	Red 49 (2)	#8 (1)	U8CRT Red 49 (1)	U8CRT Red 49 (1)	—	—	—	—
Blue 24 (1)	STD (1)	Blue 24 (1)	Blue 7 (2)	#6 (1)	U5CRT Blue 7 (1)	U5CRT Blue 7 (1)	STD (1)	STD (1)	—	—
Gray 29 (1)	STD (1)	Gray 29 (1)	Gray 8 (2)	#4 (1)	U4CRT Gray 8 (1)	U4CRT Gray 8 (1)	STD (1)	STD (1)	—	STD (1)
Brown 33 (1)	STD (1)	Brown 33 (1)	Brown 10 (2)	#2 (1)	U2CRT Brown 9 (solid)/ Brown 10 (stranded) (2)	U2CRT Brown 9 (solid)/ Brown 10 (stranded) (2)	STD (1)	STD (1)	STD (1)	STD (1)
Green 37 (1)	STD (1)	Green 37 (1)	—	#1 (1)	U1CRT Green 11 (2)	U1CRT Green 11 (2)	STD (1)	STD (1)	STD (1)	STD (1)
Pink 42H ^② (4)	STD (2)	Pink 42H ^② (4)	—	1/0 (2)	U25RT Pink 12 (2)	U25RT Pink 12 (2)	STD (1)	STD (1)	STD (1)	STD (1)
Black 45 (2)	STD (2)	Black 45 (2)	—	2/0 (2)	U26RT Black 13 (2)	U26RT Black 13 (2)	STD (1)	STD (1)	STD (1)	STD (1)
Orange 50 (2)	STD (2)	Orange 50 (2)	—	3/0 (2)	U27RT Orange 14 (2)	U27RT Orange 14 (2)	STD (1)	STD (2)	STD (1)	STD (1)
Purple 54H ^② (4)	STD (2)	Purple 54H ^② (4)	—	4/0 (2)	U28RT Purple 15 (2)	U28RT Purple 15 (2)	STD (1)	STD (2)	STD (1)	STD (1)
Yellow 62 (2)	STD (2)	Yellow 62 (2)	—	250 (2)	U29RT Yellow 16 (2)	U29RT Yellow 16 (2)	STD (1)	STD (2)	STD (1)	STD (1)

②Half width dies.

⑦Requires U die adapter.

⑧Minimum size: #4 AWG lugs and splices.

Chart continues on pages D3.60 – D3.61

For technical assistance in the U.S., call 866-405-6654 (outside the U.S., see inside back cover for directory)

A.
System
Overview

B1.
Cable
Ties

B2.
Cable
Accessories

B3.
Stainless
Steel Ties

C1.
Wiring
Duct

C2.
Surface
Raceway

C3.
Abrasion
Protection

C4.
Cable
Management

D1.
Terminals

D2.
Power
Connectors

D3.
Grounding
Connectors

E1.
Labeling
Systems

E2.
Labels

E3.
Pre-Printed
& Write-On
Markers

E4.
Permanent
Identification

E5.
Lockout/
Tagout
& Safety
Solutions

F.
Index

**For use with
Copper
Conductors**

Installation Tooling and Die Selections for: Types LCB, LCBN, LCC, LCCN and SCL (continued)

PANDUIT Part Number L = Lug S = Splice	Std. Wire Size	Wire Strip Length (In.)	PANDUIT (See Compression Connector Tools Selection Guide, Pages D3.30 – D3.32)				Thomas and Betts	
			CT-720	CT-920, CT-920CH, CT-930, CT-930CH, CT-2920, CT-2930, CT-2931, CT-930LPCH ^② , CT-940CH ^③ , CT-2940 ^③	UNI-DIE™ CT-980, CT-980CH, CT-2950 ^⑤ , CT-2980, CT-2981, CT-980LPCH ^⑥ Extended Wire Range ^⑦	CT-2001, CT-2002	TBM8	TBM12, 13642M
Die Part Number/Color Code and Die Index Number/(Number of Crimps)								
LCB300 LCBN300 LCC300 LCCN300 SCL300	300 kcmil	2-5/16 2	CD-720-4 White P66 (4)	CD-920-300 White P66 (3)	2/0 AWG – 300 kcmil (3)	CD-2001-300 White P66 (3)	White 66 (4)	White 66 ^② (4)
LCB350 LCBN350 LCC350 LCCN350 SCL350	350 kcmil	2-5/16 2	CD-720-5 Red P71 (4)	CD-920-350 Red P71 (3)	3/0 AWG – 350 kcmil (3)	CD-2001-350 Red P71 (3)	Red 71 (4)	Red 71H ^② (4)
LCB400 LCBN400 LCC400 LCCN400 SCL400	400 kcmil	2-3/8 2-1/8	CD-720-6 Blue P76 (4)	CD-920-400 Blue P76 (3)	4/0 AWG – 400 kcmil (3)	CD-2001-400 Blue P76 (4)	Blue 76 (4)	Blue 76H ^② (4)
LCB500 LCBN500 LCC500 LCCN500 SCL500	500 kcmil	2-9/16 2-1/4	CD-720-7 Brown P87 (4)	CD-920-500 Brown P87 (3)	4/0 AWG – 500 kcmil (3)	CD-2001-500 Brown P87 (4)	Brown 87 (4)	Brown 87H ^② (4)
LCB600 LCBN600 LCC600 LCCN600 SCL600	600 kcmil	2-3/4 2-11/16	—	CD-920-600 Green P94 (4)	250 – 600 kcmil (3)	—	—	Green 94H ^② (4)
LCB750 LCBN750 LCC750 LCCN750 SCL750	750 kcmil	2-15/16 2-7/8	—	CD-920-750 CD-940-750 ^④ Black P106 (4)	500 – 750 kcmil (3)	—	—	Black 106H ^② (4)
LCB800 LCBN800 LCC800 LCCN800	800 kcmil	3	—	CD-940-800 ^④ Orange P107 (4)	—	—	—	—
LCB1000 LCBN1000 LCC1000 LCCN1000 SCL1000	1000 kcmil	3-1/16 3	—	CD-940-1000 ^④ White P125 (4)	—	—	—	Yellow 125H ^② (4)

②Half width dies.
 ③CD-920 dies can be used with CT-940CH and CT-2940 tools with CD-940-DA adapter.
 ④CD-940 dies to be used exclusively with CT-940CH and CT-2940 tools.
 ⑤Maximum size: 500 kcmil lugs and 250 kcmil splices.
 ⑥Maximum size: 250 kcmil lugs and splices. No extended wire range.
 ⑦Maximum size: 500 kcmil lugs and splices.

**For use with
Copper
Conductors**

Installation Tooling and Die Selections for: Types LCB, LCBN, LCC, LCCN and SCL (continued)

Thomas and Betts			Burdny			Anderson	Penn-Union	Greenlee
TBM15, TBM15I, TBM15BSCR	TBM8-750M-1, TBM8-750, TBM750BSCR®, TBM8-750BSCR	TBM14M, TBM14BSCR, BPLT14BSCR, 13100A	Y35, Y35BH, Y39, Y39BH, Y750, Y750-2, Y750BH, Y750HS, Y750BH-2, PAT750, BAT750, BAT35	Y45 ^⑦ , Y46 ^⑦	Y644M, Y644HS, Y644MBH, PAT644, BAT644	VC6	TDY-1	1989
Die Part Number/Color Code and Die Index Number/(Number of Crimps)								
White 66 (3)	STD (3)	White 66 (3)	U30RT White 17 (3)	U30RT White 17 (3)	STD (1)	STD (3)	STD (2)	STD (1)
Red 71H ^② (4)	STD (3)	Red 71 (4)	U31RT Red 18 (3)	U31RT Red 18 (3)	STD (1)	STD (3)	STD (2)	STD (1)
Blue 76H ^② (4)	STD (3)	Blue 76 (4)	U32RT Blue 19 (3)	U32RT Blue 19 (3)	STD (1)	STD (3)	STD (2)	STD (1)
Brown 87H ^② (4)	STD (3)	Brown 87 (4)	U34RT Brown 20 (3)	U34RT Brown 20 (3)	STD (1)	STD (3)	STD (2)	STD (1)
Green 94H ^② (4)	STD (4)	Green 94 (4)	U36RT Green 22 (4)	U36RT Green 22 (4)	STD (1)	—	STD (4)	—
Black 106H ^② (4)	STD (4)	Black 106 (4)	U39RT Black 24 (5)	U39RT Black 24 (5)	STD (1)	—	STD (2)	—
—	—	—	—	—	—	—	—	—
125H ^② (4)	—	125H ^② (4)	—	S44RT White 27 (6)	—	—	—	—

②Half width dies.

⑦Requires U die adapter.

⑧Minimum size: #4 AWG lugs and splices.

A.
System
Overview

B1.
Cable Ties

B2.
Cable
Accessories

B3.
Stainless
Steel Ties

C1.
Wiring
Duct

C2.
Surface
Raceway

C3.
Abrasion
Protection

C4.
Cable
Management

D1.
Terminals

D2.
Power
Connectors

D3.
Grounding
Connectors

E1.
Labeling
Systems

E2.
Labels

E3.
Pre-Printed
& Write-On
Markers

E4.
Permanent
Identification

E5.
Lockout/
Tagout
& Safety
Solutions

F.
Index

A. System Overview

B1. Cable Ties

B2. Cable Accessories

B3. Stainless Steel Ties

C1. Wiring Duct

C2. Surface Raceway

C3. Abrasion Protection

C4. Cable Management

D1. Terminals

D2. Power Connectors

D3. Grounding Connectors

E1. Labeling Systems

E2. Labels

E3. Pre-Printed & Write-On Markers

E4. Permanent Identification

E5. Lockout/Tagout & Safety Solutions

F. Index

For use with Copper Conductors

Installation Tooling and Die Selections for: Types LCBH, LCCH, and SCH

How to read this chart

For LCBH6 lug and CT-2001 crimping tool:

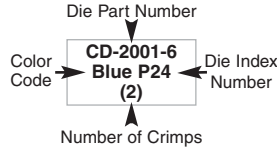

PANDUIT (See Compression Connector Tools Selection Guide, Pages D3.30 – D3.32)

Thomas and Betts

PANDUIT Part Number	Std. Wire Size	Wire Strip Length (In.)	PANDUIT (See Compression Connector Tools Selection Guide, Pages D3.30 – D3.32)					Thomas and Betts		
			CT-1700 ^①	CT-720	CT-920, CT-920CH, CT-2920, CT-930, CT-930CH, CT-2930, CT2931, CT-930LPCH ^⑤ , CT-940CH ^② , CT-2940 ^③	UNI-DIE™ CT-980, CT-980CH, CT-2950 ^⑤ , CT-2980 ^⑥ , CT-2981 ^⑥ , CT-980LPCH ^⑥ Extended Wire Range	CT-2001, CT-2002	TBM5	TBM8	TBM12 13642M
L = Lug S = Splice			Die Part Number/Color Code and Die Index Number/(Number of Crimps)							
LCBH6 LCCH6 SCH6	#6 AWG	1-1/8 15/16	Blue P24 (3)	CD-720-1 Blue P24 (2)	CD-920-6 Blue P24 (1)	—	CD-2001-6 Blue P24 (2)	Blue 24 (1)	Blue 24 (1)	Blue 24 (1)
LCBH4 LCCH4 SCH4	#4 AWG	1-1/8 15/16	Gray P29 (3)	CD-720-1 Gray P29 (2)	CD-920-4 Gray P29 (1)	#2 AWG SOL, #3 AWG STR (1)	CD-2001-4 Gray P29 (2)	Gray 29 (1)	Gray 29 (1)	Gray 29 (1)
LCBH2 LCCH2 SCH2	#2 AWG	1-1/4 1	Brown P33 (3)	CD-720-1 Brown P33 (2)	CD-920-2 Brown P33 (1)	#6 – #4 AWG (1)	CD-2001-2 Brown P33 (2)	Brown 33 (1)	Brown 33 (1)	Brown 33 (1)
LCBH1 LCCH1 SCH1	#1 AWG	1-7/16 1	Green P37 (3)	CD-720-2 Green P37 (2)	CD-920-1 Green P37 (1)	#6 – #2 AWG (1)	CD-2001-1 Green P37 (2)	Green 37 (1)	Green 37 (1)	Green 37 (1)
LCBH1/0 LCCH1/0 SCH1/0	1/0 AWG	1-1/2 1	—	CD-720-2 Pink P42 (2)	CD-920-1/0 Pink P42 (2)	#6 – #1 AWG (2)	CD-2001-1/0 Pink P42 (2)	Pink 42 (2)	Pink 42 (2)	Pink 42 (2)
LCBH2/0 LCCH2/0 SCH2/0	2/0 AWG	1-9/16 1-1/16	—	CD-720-2 Black P45 (3)	CD-920-2/0 Black P45 (3)	#4 – 1/0 AWG (2)	CD-2001-2/0 Black P45 (3)	Black 45 (3)	Black 45 (3)	Black 45 (2)
LCBH3/0 LCCH3/0 SCH3/0	3/0 AWG	1-9/16 1-3/16	—	CD-720-2 Orange P50 (3)	CD-920-3/0 Orange P50 (3)	#2 – 2/0 AWG (2)	CD-2001-3/0 Orange P50 (3)	Orange 50 (3)	Orange 50 (3)	Orange 50 (2)
LCBH4/0 LCCH4/0 SCH4/0	4/0 AWG	1-5/8 1-3/16	—	CD-720-3 Purple P54 (3)	CD-920-4/0 Purple P54 (3)	#1 – 3/0 AWG (2)	CD-2001-4/0 Purple P54 (3)	Purple 54 (3)	Purple 54 (3)	Purple 54 (3)
LCBH250 LCCH250 SCH250	250 kcmil	1-11/16 1-1/4	—	CD-720-3 Yellow P62 (4)	CD-920-250 Yellow P62 (3)	1/0 – 4/0 AWG (3)	CD-2001-250 Yellow P62 (3)	Yellow 62 (4)	Yellow 62 (4)	Yellow 62 (2)
LCBH300 LCCH300 SCH300	300 kcmil	2-5/16 2	—	CD-720-4 White P66 (4)	CD-920-300 White P66 (3)	2/0 AWG – 250 kcmil (3)	CD-2001-300 White P66 (3)	—	White 66 (4)	White 66H ^② (4)
LCBH350 LCCH350 SCH350	350 kcmil	2-5/16 2	—	CD-720-5 Red P71 (4)	CD-920-350 Red P71 (3)	3/0 AWG – 300 kcmil (3)	CD-2001-350 Red P71 (3)	—	Red 71 (4)	Red 71H ^② (4)
LCBH400 LCCH400 SCH400	400 kcmil	2-3/8 2-1/8	—	CD-720-6 Blue P76 (4)	CD-920-400 Blue P76 (3)	4/0 AWG – 350 kcmil (3)	CD-2001-400 Blue P76 (4)	—	Blue 76 (4)	Blue 76H ^② (4)
LCBH500 LCCH500 SCH500	500 kcmil	2-9/16 2-1/4	—	CD-720-7 Brown P87 (4)	CD-920-500 Brown P87 (3)	4/0 AWG – 400 kcmil (3)	CD-2001-500 Brown P87 (4)	—	Brown 87 (4)	Brown 87H ^② (4)
LCBH600 LCCH600 SCH600	600 kcmil	2-3/4 2-11/16	—	—	CD-920-600 Green P94 (4)	250 – 500 kcmil (3)	—	—	—	Green 94H ^② (4)
LCBH750 LCCH750 SCH750	750 kcmil	2-15/16 2-7/8	—	—	CD-920-750, CD-940-750 ^④ Black P106 (4)	500 – 600 kcmil (3)	—	—	—	Black 106H ^② (4)
LCBH1000 LCCH1000 SCH1000	1000 kcmil	3-1/16 3	—	—	CD-940-1000 ^④ Green P125 (4)	—	—	—	—	125H ^② (4)

①The CT-1700 crimp die pockets are integrated into the tool frame.
 ②Half width dies.
 ③CD-920 dies can be used with CT-940CH and CT-2940 tools with CD-940-DA adapter.
 ④CD-940 dies to be used exclusively with CT-940CH and CT-2940 tools.

⑤Maximum size: 500 kcmil lugs and 250 kcmil splices.
 ⑥Maximum size: 250 kcmil lugs and splices. No extended wire range.
 ⑦Maximum size: 500 kcmil lugs and splices.

**For use with
Copper
Conductors**

Installation Tooling and Die Selections for: Types LCBH, LCCH, and SCH (continued)

Thomas and Betts			Burndy				Anderson	Penn-Union	Greenlee
TBM15, TBM15I, TBM15BSCR	TBM8-750M-1, TBM8-750, TBM8-750BSCR, TBM750BSCR®	TBM14M, TBM14BSCR, BPL14BSCR, 13100A	MY29	Y39, Y35, Y35BH, BAT35, Y750, Y750BH-2, Y750HS, Y750-2, BAT750, PAT750, Y39BH, Y750BH	Y45 ^⑦ , Y46 ^⑦	Y644, Y644HS, PAT644, BAT644, Y644MBH	VC6	TDY-1	1989
Die Part Number/Color Code and Die Index Number/(Number of Crimps)									
Blue 24 (1)	STD (1)	Blue 24 (1)	6 (1)	U5CRT Blue 7 (1)	U5CRT Blue 7 (1)	STD (1)	STD (1)	—	—
Gray 29 (1)	STD (1)	Gray 29 (1)	4 (1)	U4CRT Gray 8 (1)	U4CRT Gray 8 (1)	STD (1)	STD (1)	—	STD (1)
Brown 33 (1)	STD (1)	Brown 33 (1)	2 (1)	U2CRT Brown 10 (2)	U2CRT Brown 10 (2)	STD (1)	STD (1)	STD (1)	STD (1)
Green 37 (1)	STD (1)	Green 37 (1)	1 (1)	U1CRT Green 11 (2)	U1CRT Green 11 (2)	STD (1)	STD (1)	STD (1)	STD (1)
Pink 42H ^② (4)	STD (2)	Pink 42H ^② (4)	1/0 (2)	U25RT Pink 12 (2)	U25RT Pink 12 (2)	STD (1)	STD (1)	STD (1)	STD (1)
Black 45 (2)	STD (2)	Black 45 (2)	2/0 (2)	U26RT Black 13 (2)	U26RT Black 13 (2)	STD (1)	STD (1)	STD (1)	STD (1)
Orange 50 (2)	STD (2)	Orange 50 (2)	3/0 (2)	U27RT Orange 14 (2)	U27RT Orange 14 (2)	STD (1)	STD (2)	STD (1)	STD (1)
Purple 54H ^② (4)	STD (2)	Purple 54H ^② (4)	4/0 (2)	U28RT Purple 15 (2)	U28RT Purple 15 (2)	STD (1)	STD (2)	STD (1)	STD (1)
Yellow 62 (2)	STD (2)	Yellow 62 (2)	250 (2)	U29RT Yellow 16 (2)	U29RT Yellow 16 (2)	STD (1)	STD (2)	STD (2)	STD (1)
White 66H ^② (4)	STD (3)	White 66 (4)	—	U30RT White 17 (3)	U30RT White 17 (3)	STD (1)	STD (3)	STD (2)	STD (1)
Red 71H ^② (4)	STD (3)	Red 71H ^② (4)	—	U31RT Red 18 (3)	U31RT Red 18 (3)	STD (1)	STD (3)	STD (2)	STD (1)
Blue 76H ^② (4)	STD (3)	Blue 76 (4)	—	U32RT Blue 19 (3)	U32RT Blue 19 (3)	STD (1)	STD (3)	STD (2)	STD (1)
Brown 87H ^② (4)	STD (3)	Brown 87H ^② (4)	—	U34RT Brown 20 (3)	U34RT Brown 20 (3)	STD (1)	STD (3)	STD (2)	STD (1)
Green 94H ^② (4)	STD (4)	Green 94H ^② (4)	—	U36RT Green 22 (4)	U36RT Green 22 (4)	STD (1)	—	STD (2)	—
Black 106H ^② (4)	STD (4)	Black 106H ^② (4)	—	U39RT Black 24 (5)	U39RT Black 24 (5)	STD (1)	—	STD (2)	—
125H ^② (4)	—	125H ^② (4)	—	—	S44RT White 27 (6)	—	—	—	—

②Half width dies.

⑦Requires U die adapter.

⑧Minimum size: #4 AWG lugs and splices.

A.
System
Overview

B1.
Cable
Ties

B2.
Cable
Accessories

B3.
Stainless
Steel Ties

C1.
Wiring
Duct

C2.
Surface
Raceway

C3.
Abrasion
Protection

C4.
Cable
Management

D1.
Terminals

D2.
Power
Connectors

D3.
Grounding
Connectors

E1.
Labeling
Systems

E2.
Labels

E3.
Pre-Printed
& Write-On
Markers

E4.
Permanent
Identification

E5.
Lockout/
Tagout
& Safety
Solutions

F.
Index

A. System Overview

B1. Cable Ties

B2. Cable Accessories

B3. Stainless Steel Ties

C1. Wiring Duct

C2. Surface Raceway

C3. Abrasion Protection

C4. Cable Management

D1. Terminals

D2. Power Connectors

D3. Grounding Connectors

E1. Labeling Systems

E2. Labels

E3. Pre-Printed & Write-On Markers

E4. Permanent Identification

E5. Lockout/Tagout & Safety Solutions

F. Index

For use with Copper Conductors

Installation Tooling and Die Selections for: Type SCT

How to read this chart

For SCT2-2 splice and CT-2001 crimping tool:

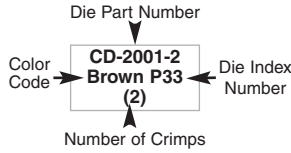

PANDUIT Part Number	Std. Wire Size	Wire Strip Length (In.)	PANDUIT (See Compression Connector Tools Selection Guide, Pages D3.30 – D3.32)					Thomas and Betts	
			CT-1700 ^①	CT-720	CT-920, CT-920CH, CT-2920, CT-930, CT-930CH, CT-2930, CT-2931, CT-940CH ^③ , CT-2940 ^③	CT-980, CT-980CH, CT-2950 ^④ , CT-2980, CT-2981	CT-2001, CT-2002	TBM5	TBM8
Die Part Number/Color Code and Die Index Number/(Number of Crimps)									
SCT2-2	#2 AWG	2	Brown P33 (3)	CD-720-1 Brown P33 (2)	CD-920-2 Brown P33 (1)	STD (1)	CD-2001-2 Brown P33 (2)	Brown 33 (1)	Brown 33 (1)
	#2 AWG	1-9/16							
SCT1/0-1/0	1/0 AWG	2-1/16	Pink P42 (3)	CD-720-2 Pink P42 (2)	CD-920-1/0 Pink P42 (2)	STD (1)	CD-2001-1/0 Pink P42 (2)	Pink 42 (2)	Pink 43 (2)
	1/0 AWG	1-9/16							
SCT2/0-2/0	2/0 AWG	2-1/16	—	CD-720-2 Black P45 (3)	CD-920-2/0 Black P45 (3)	STD (1)	CD-2001-2/0 Black P45 (3)	Black 45 (3)	Black 45 (3)
	2/0 AWG	1-9/16							
SCT4/0-1/0	4/0 AWG	2-1/16	—	CD-720-2 Orange P50 (3)	CD-920-3/0 Orange P50 (3)	STD (1)	CD-2001-3/0 Orange P50 (3)	Orange 50 (3)	Orange 50 (3)
	1/0 AWG	1-9/16		CD-720-2 Pink P42 (3)	CD-920-1/0 Pink P42 (3)		CD-2001-1/0 Pink P42 (3)	Pink 42 (3)	Pink42 (3)
SCT4/0-4/0	4/0 AWG	2-1/8	—	CD-720-3 Purple P54 (3)	CD-920-4/0 Purple P54 (3)	STD (1)	CD-2001-4/0 Purple P54 (3)	Purple 54 (3)	Purple 54 (3)
	4/0 AWG	1-11/16							
SCT250-250	250 kcmil	2-3/16	—	CD-720-3 Yellow P62 (4)	CD-920-250 Yellow P62 (3)	STD (1)	CD-2001-250 Yellow P62 (3)	Yellow 62 (4)	Yellow 62 (4)
	250 kcmil	1-11/16							
SCT300-300	300 kcmil	2-13/16	—	CD-720-4 White P65 (4)	CD-920-300 White P65 (3)	STD (1)	CD-2001-300 White P66 (3)	—	White 66 (4)
	300 kcmil	2-1/16							
SCT350-350	350 kcmil	2-13/16	—	CD-720-5 Red P71 (4)	CD-920-350 Red P71 (3)	STD (1)	CD-2001-350 Red P71 (3)	—	Red 71 (4)
	350 kcmil	2-1/16							
SCT500-4/0	500 kcmil	2-15/16	—	CD-720-7 Brown P87 (4)	CD-920-500 Brown P87 (3)	STD (1)	CD-2001-500 Brown P87 (4)	—	Brown 87 (4)
	4/0 AWG	2-15/16		CD-720-3 Purple P54 (4)	CD-920-4/0 Purple P54 (4)		CD-2001-4/0 Purple P54 (4)	—	Purple 54 (4)
SCT500-500	500 kcmil	3-1/8	—	CD-720-7 Brown P87 (4)	CD-920-500 Brown P87 (3)	STD (1)	CD-2001-500 Brown P87 (4)	—	Brown 87 (4)
	500 kcmil	2-9/16							

① The CT-1700 crimp die pockets are integrated into the tool frame.
 ③ CD-920 dies can be used with CT-940CH and CT-2940 tools with CD-940-DA adapter.
 ④ Maximum size: 250 kcmil.

For use with
Copper
Conductors

Installation Tooling and Die Selections for: Type SCT (continued)

Thomas and Betts				Burndy			Anderson	Penn-Union	Greenlee
TBM12, 13642M	TBM15, TBM15I, TBM15BSCR	TBM8-750M-1, TBM8-750, TBM8-750BSCR	TBM14M, TBM14BSCR, BPLT14BSCR, 13100A	MY29	Y39, Y35, Y35BH, Y750HS, Y750, BAT35, Y45, Y39BH, Y46, Y750-2, BAT750, PAT750, Y750BH-2, Y750BH	Y644, Y644HS, PAT644, BAT644, Y644MBH	VC6	TDY-1	1989
Die Part Number/Color Code and Die Index Number/(Number of Crimps)									
Brown 33 (1)	Brown 33 (1)	STD (1)	Brown 33 (1)	2 (1)	U2CRT Brown 10 (2)	STD (1)	STD (1)	STD (1)	STD (1)
Pink 42H [Ⓜ] (2)	Pink 42H [Ⓜ] (4)	STD (2)	Pink 42H [Ⓜ] (4)	1/0 (2)	U25RT Pink 12 (2)	STD (1)	STD (1)	STD (1)	STD (1)
Black 45 (2)	Black 45 (2)	STD (2)	Black 45 (2)	2/0 (2)	U26RT Black 13 (2)	STD (1)	STD (1)	STD (1)	STD (1)
Orange 50 (2)	Orange 50 (2)	STD (2)	Orange 50 (2)	3/0 (2)	U27RT Orange 14 (2)	STD (1)	STD (2)	STD (1)	STD (1)
Pink 42 (2)	Pink 42H [Ⓜ] (4)		Pink 42H [Ⓜ] (4)	1/0 (2)	U25RT Pink 12 (2)				
Purple 54 (2)	Purple 54H (4)	STD (2)	Purple 54H [Ⓜ] (4)	4/0 (2)	U28RT Purple 15 (2)	STD (1)	STD (2)	STD (1)	STD (1)
Yellow 62 (2)	Yellow 62 (2)	STD (2)	Yellow 62 (2)	250 (2)	U29RT Yellow 16 (2)	STD (1)	STD (2)	STD (1)	STD (1)
White 66H [Ⓜ] (4)	White 66H [Ⓜ] (4)	STD (3)	White 66H [Ⓜ] (4)	—	U30RT White 17 (3)	STD (1)	STD (3)	STD (2)	STD (1)
Red 71H [Ⓜ] (4)	Red 71H [Ⓜ] (4)	STD (3)	Red 71 (3)	—	U31RT Red 18 (3)	STD (1)	STD (3)	STD (2)	STD (1)
Brown 87H [Ⓜ] (4)	Brown 87H [Ⓜ] (4)	STD (3)	Brown 87 (3)	—	U34RT Brown 20 (3)	STD (1)	STD (3)	STD (2)	STD (1)
Olive 54 (4)	Olive 54H [Ⓜ] (4)		Olive 54H [Ⓜ] (3)	—	U28RT Purple 15 (3)				
Brown 87H [Ⓜ] (4)	Brown 87H [Ⓜ] (4)	STD (3)	Brown 87H [Ⓜ] (4)	—	U34RT Brown 20 (3)	STD (1)	STD (3)	STD (2)	STD (1)

ⓂHalf width dies.

A.
System
Overview

B1.
Cable
Ties

B2.
Cable
Accessories

B3.
Stainless
Steel Ties

C1.
Wiring
Duct

C2.
Surface
Raceway

C3.
Abrasion
Protection

C4.
Cable
Management

D1.
Terminals

D2.
Power
Connectors

D3.
Grounding
Connectors

E1.
Labeling
Systems

E2.
Labels

E3.
Pre-Printed
& Write-On
Markers

E4.
Permanent
Identification

E5.
Lockout/
Tagout
& Safety
Solutions

F.
Index

A. System Overview

B1. Cable Ties

B2. Cable Accessories

B3. Stainless Steel Ties

C1. Wiring Duct

C2. Surface Raceway

C3. Abrasion Protection

C4. Cable Management

D1. Terminals

D2. Power Connectors

D3. Grounding Connectors

E1. Labeling Systems

E2. Labels

E3. Pre-Printed & Write-On Markers

E4. Permanent Identification

E5. Lockout/Tagout & Safety Solutions

F. Index

For use with Copper Conductors

Installation Tooling and Die Selections for: Types LCAX, LCAXN, LCBX, LCDX, LCDXN and LCCX

How to read this chart

For LCAX6 lug and CT-2001 crimping tool:

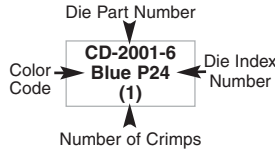

PANDUIT (See Compression Connector Tools Selection Guide, Pages D3.30 – D3.32)

PANDUIT Part Number	Std. Wire Size	Cable Classes	Wire Strip Length (In.)	Die Part Number/Color Code and Die Index Number (Number of Crimps)		
				CT-1700 ^①	CT-2001, CT-2002	CT-920, CT-920CH, CT-2920, CT-930, CT-930CH, CT-2930, CT-2931, CT-2940 ^③ , CT-940CH ^③
LCAX8, LCDX8, LCDXN8, LCEX8, LCJX8	#8 AWG	Compact, B, G, H, I, K, M, Locomotive (DLO)	1/2	Red P21 (2)	CD-2001-8 Red P21 (1)	CD-920-8 Red P21 (1)
			3/4	Red P21 (3)	CD-2001-8 Red P21 (2)	
LCAX6, LCDX6, LCDXN6, LCEX6, LCJX6	#6 AWG	Compact, B, G, H, I, K, M, Locomotive (DLO)	9/16	Blue P24 (2)	CD-2001-6 Blue P24 (1)	CD-920-6 Blue P24 (1)
			1-1/8	Blue P24 (3)	CD-2001-6 Blue P24 (2)	
LCAX4, LCDX4, LCDXN4, LCEX4, LCJX4	#4 AWG	Compact, B, G, H, I, K, M Locomotive (DLO)	5/8	Gray P29 (2)	CD-2001-4 Gray P29 (1)	CD-920-4 Gray P29 (1)
			1-1/8	Gray P29 (3)	CD-2001-4 Gray P29 (2)	
LCBX4, LCCX4	#5, #4, #3	Locomotive (DLO)				1-1/8
			LCAX2, LCDX2, LCDXN2, LCEX2, LCJX2	#2 AWG	Compact, B, G, H, I, K, M, Locomotive (DLO)	
1-7/16	Brown P33 (3)	CD-2001-2 Brown P33 (2)				
LCAX1, LCDX1, LCDXN1, LCEX1, LCJX1	#1 AWG	Compact, B, G, H, I, K, M, Locomotive (DLO)	3/4	—	CD-2001-1 Green P37 (1)	CD-920-1 Green P37 (1)
			1-1/2	—	CD-2001-1 Green P37 (2)	CD-920-1 Green P37 (2)
LCAX1/0, LCDX1/0, LCDXN1/0, LCEX1/0, LCJX1/0	1/0 AWG	Compact, B, G, H, I, K, M, Locomotive (DLO)	3/4	—	CD-2001-1/0 Pink P42 (2)	CD-920-1/0 Pink P42 (1)
			1-9/16	—	CD-2001-1/0 Pink P42 (3)	CD-920-1/0 Pink P42 (3)
LCAX2/0, LCDX2/0, LCDXN2/0, LCEX2/0, LCJX2/0	2/0 AWG	Compact, B, G, H, I, K, M, Locomotive (DLO)	7/8	—	CD-2001-2/0 Black P45 (2)	CD-920-2/0 Black P45 (1)
			1-9/16	—	CD-2001-2/0 Black P45 (3)	CD-920-2/0 Black P45 (3)
LCAX3/0, LCDX3/0, LCDXN3/0, LCEX3/0, LCJX3/0	3/0 AWG	Compact, B, G, H, I, K, M, Locomotive (DLO)	1	—	CD-2001-3/0 Orange P50 (2)	CD-920-3/0 Orange P50 (1)
			1-5/8	—	CD-2001-3/0 Orange P50 (3)	CD-920-3/0 Orange P50 (3)

①The CT-1700 crimp die pockets are integrated into the tool frame.
 ③CD-920 dies can be used with CT-940CH and CT-2940 tools with CD-940-DA adapter.
 ⑥Does not include class K flex conductor with Burndy tools.
 ⑦Does not include class M flex conductor with Thomas and Betts tools.
 ⑧Does not include class K and M flex conductor with Thomas and Betts tools.
 ⑨Does not include class K flex conductor with Thomas and Betts tools.

For use with
Copper
Conductors

Installation Tooling and Die Selections for: Types LCAX, LCAXN, LCBX, LCDX, LCDXN and LCCX (continued)

Thomas and Betts					Burndy				
TBM12	TBM8	TBM6, 25000	TBM6BSCR, TBM6H	TBM8-750, TBM8-750M-1	TBM14BSCR, TBM14M, TBM15	BCT500HS, Y500CT-HS	Y644M	Y35, Y39, Y750, Y46®, Y750-2, Y750BH, BAT35-14V, BAT750-14V, Pat750-18V	MRC840
Die Part Number/Color Code and Die Index Number/(Number of Crimps)									
TBM12D-1 Red 21 (1)	13461 Red 21 (1)	13475 & 13477 Red 21 (1)	6TON21 Red 21 (1)	STD (1)	15520 Red 21 (1)	W8CRT Red 49 (1)	—	U8CRT Red 49 (1)	Red 49 (1)
TBM12D-1 Red 21 (2)	13461 Red 21 (2)	13475 & 13477 Red 21 (2)	6TON21 Red 21 (2)	STD (2)	15520 Red 21 (2)	W8CRT Red 49 (2)	—	U8CRT Red 49 (2)	Red 49 (2)
TBM12D-1 Blue 24 (1)	13461 Blue 24 (1)	13475 & 13477 Blue 24 (1)	6TON24 Blue 24 (1)	STD (1)	15522 Blue 24 (1)	W5CRT Blue 7 (1)	(1)	U5CRT Blue 7 (1)	Blue 7 (1)
TBM12D-1 Blue 24 (2)	13461 Blue 24 (2)	13475 & 13477 Blue 24 (2)	6TON24 Blue 24 (2)	STD (2)	15522 Blue 24 (2)	W5CRT Blue 7 (2)	(2)	U5CRT Blue 7 (2)	Blue 7 (2)
TBM12D-2 Gray 29 (1)	13461 Gray 29 (1)	13472 & 13476 Gray 29 (1)	6TON29 Gray 29 (1)	STD (1)	15527-CK Gray 29 (1)	W4CRT Gray 8 (1)	(1)	U4CRT Gray 8 (1)	—
TBM12D-2 Gray 29 (3)	13461 Gray 29 (2)	13472 & 13476 Gray 29 (3)	6TON29 Gray 29 (2)	STD (3)	15527-CK Gray 29 (2)	W4CRT Gray 8 (2)	(2)	U4CRT Gray 8 (2)	—
TBM12D-2 Brown 33 (1)	13461 Brown 33 (1)	13474 & 13477 Brown 33 (1)	6TON33 Brown 33 (1)	STD (1)	15528 Brown 33 (1)	W2CRT Brown 10 (1)	(1)	U2CRT Brown 10 (1)	—
TBM12D-2 Brown 33 (3)	13461 Brown 33 (3)	13474 & 13477 Brown 33 (3)	6TON33 Brown 33 (2)	STD (3)	15528 Brown 33 (2)	W2CRT Brown 10 (2)	(2)	U2CRT Brown 10 (2)	—
TBM12D-1 Green 37 (1)	13462 Green 37 (1)	13474 & 13477 Green 37 (1)	6TON37 Green 37 (1)	STD (1)	15513-CK Green 37 (1)	W1CRT-1 Green 11 (1)	(1)	U1CRT Green 11 (1)	—
TBM12D-3 Green 37 (3)	13462 Green 37 (3)	13474 & 13477 Green 37 (3)	6TON37 Green 37 (2)	STD (3)	15513-CK Green 37 (2)	W1CRT-1 Green 11 (2)	(2)	U1CRT Green 11 (2)	—
TBM12D-3 Pink 42 (1)	13462 Pink 42 (1)	13475 & 13477 Pink 42 (2)	6TON42 Pink 42 (2)	STD (1)	15508 Pink 42 (2)	W25RT Pink 12 (2)	(1)	U25RT Pink 12 (1)	—
TBM12D-3 Pink 42 (3)	13462 Pink 42 (3)	13475 & 13477 Pink 42 (3)	6TON42 Pink 42 (3)	STD (3)	15508 Pink 42 (3)	W25RT Pink 12 (3)	(2)	U25RT Pink 12 (2)	—
TBM12D-4 Blk/Gold 45 (1)	13462 Black 45 (2)	13474 & 13477 Black 45 (2)	6TON45 Black 45 (2)	STD (1)	15526 Black 45 (1)	W26RT Black 13 (2)	(1)	U26RT Black 13 (1)	—
TBM12D-4 Blk/Gold 45 (3)	13462 Black 45 (4)	13474 & 13477 Black 45 (3)	6TON45 Black 45 (3)	STD (3)	15526 Black 45 (2)	W26RT Black 13 (3)	(2)	U26RT Black 13 (2)	—
TBM12D-4 Org/Tan 50 (1)	13462 Orange 50 (2)	13474 & 13477 Orange 50 (2)	6TON50 Orange 50 (2)	STD (1)	15530 Orange 50 (2)	W27RT Orange 14 (2)	(1)	U27RT Orange 14 (1)	—
TBM12D-4 Org/Tan 50 (3)	13462 Orange 50 (4)	13474 & 13477 Orange 50 (3)	6TON50 Orange 50 (3)	STD (3)	15530 Orange 50 (3)	W27RT Orange 14 (4)	(2)	U27RT Orange 14 (2)	—

⑤Requires U die adapter.

Chart continues on pages D3.68–D3.69

A.
System
Overview

B1.
Cable Ties

B2.
Cable
Accessories

B3.
Stainless
Steel Ties

C1.
Wiring
Duct

C2.
Surface
Raceway

C3.
Abrasion
Protection

C4.
Cable
Management

D1.
Terminals

D2.
Power
Connectors

D3.
Grounding
Connectors

E1.
Labeling
Systems

E2.
Labels

E3.
Pre-Printed
& Write-On
Markers

E4.
Permanent
Identification

E5.
Lockout/
Tagout
& Safety
Solutions

F.
Index

A. System Overview

B1. Cable Ties

B2. Cable Accessories

B3. Stainless Steel Ties

C1. Wiring Duct

C2. Surface Raceway

C3. Abrasion Protection

C4. Cable Management

D1. Terminals

D2. Power Connectors

D3. Grounding Connectors

E1. Labeling Systems

E2. Labels

E3. Pre-Printed & Write-On Markers

E4. Permanent Identification

E5. Lockout/Tagout & Safety Solutions

F. Index

For use with Copper Conductors

Installation Tooling and Die Selections for: Types LCAX, LCAXN, LCBX, LCDX, LCDXN and LCCX (continued)

				PANDUIT (See Compression Connector Tools Selection Guide, Pages D3.30 – D3.32)		
				CT-1700 ^①	CT-2001, CT-2002	CT-920, CT-920CH, CT-2920, CT-930, CT-930CH, CT-2930, CT-2931, CT-2940 ^③ , CT-940CH ^③
				Die Part Number/Color Code and Die Index Number/(Number of Crimps)		
PANDUIT Part Number	Std. Wire Size	Cable Classes	Wire Strip Length (In.)			
LCAX4/0, LCDX4/0, LCDXN4/0, LCEX4/0, LCJX4/0	4/0 AWG	Compact, B, G, H, I, K, M, Locomotive (DLO) ^⑦	1-1/16	—	CD-2001-4/0 Purple P54 (2)	CD-920-4/0 Purple P54 (1)
LCBX4/0, LCCX4/0			2-5/16		CD-2001-4/0 Purple P54 (3)	CD-920-4/0 Purple P54 (3)
LCAX250, LCAXN250, LCDX250, LCDXN250, LCEX250, LCJX250	250 kcmil	G, H, I, K, M	1-1/16	—	CD-2001-250 Yellow P62 (2)	CD-920-250 Yellow P62 (1)
LCBX250, LCCX250	262.6 kcmil	Locomotive (DLO)	2-5/16		CD-2001-250 Yellow P62 (3)	CD-920-250 Yellow P62 (3)
LCAX300, LCDX300, LCDXN300, LCEX300, LCJX300	300 kcmil	G, H, I, K, M	1-1/4	—	CD-2001-350 Red P71 (2)	CD-920-350 Red P71 (2)
	313.1 kcmil	Locomotive (DLO)			CD-2001-350 Red P71 (4)	CD-920-350 Red P71 (3)
LCBX300, LCCX300	300 kcmil	G, H, I, K, M	2-3/8	—	CD-2001-400 Blue P76 (2)	CD-920-400 Blue P76 (2)
	313.1 kcmil	Locomotive (DLO)			CD-2001-400 Blue P76 (4)	CD-920-400 Blue P76 (3)
LCAX350, LCDX350, LCDXN350, LCEX350, LCJX350	350 kcmil	G, H, I, K, M	1-3/8	—	CD-2001-450 Black P106 (2)	CD-920-450 Black P106 (2)
	373.7 kcmil	Locomotive (DLO)			CD-2001-450 Black P106 (4)	CD-920-450 Black P106 (3)
LCBX350, LCCX350	350 kcmil	G, H, I, K, M	2-9/16	—	CD-2001-500 Brown P87 (2)	CD-920-500 Brown P87 (2)
	373.7 kcmil	Locomotive (DLO)			CD-2001-500 Brown P87 (4)	CD-920-500 Brown P87 (3)
LCAX450, LCDX450, LCDXN450, LCEX450, LCJX450	450 kcmil	G, H, I, K, M	1-7/16	—	—	CD-920-500A Pink P99 (2)
	444.4 kcmil	Locomotive (DLO)			—	CD-920-500A Pink P99 (4)
LCBX450, LCCX450	450 kcmil	G, H, I, K, M	2-3/4	—	—	CD-920-500A Pink P99 (2)
	444.4 kcmil	Locomotive (DLO)			—	CD-940-750 ^④ Black P106 (2)
LCAX500, LCDX500, LCDXN500, LCEX500, LCJX500	500 kcmil	G, H, I, K, M	1-9/16	—	—	CD-940-750X ^④ Yellow (2)
LCBX500, LCCX500	535.3 kcmil	Locomotive (DLO)	2-15/16	—	—	
LCAX600, LCDX600, LCDXN600, LCEX600, LCJX600	600 kcmil	G, H, I	1-9/16	—	—	
LCAX650, LCDX650, LCDXN650, LCEX650, LCJX650	646.4 kcmil	Locomotive (DLO)	1-1/2	—	—	
LCAX750, LCDX750, LCDXN750, LCEX750, LCJX750	777.7 kcmil	Locomotive (DLO)	1-3/4	—	—	

①The CT-1700 crimp die pockets are integrated into the tool frame.
 ③CD-920 dies can be used with CT-940CH and CT-2940 tools with CD-940-DA adapter.
 ④CD-940 dies to be used exclusively with CT-940CH and CT-2940 tools.
 ⑦Does not include class M flex conductor with Thomas and Betts tools.

For use with
Copper
Conductors

Installation Tooling and Die Selections for: Types LCAX, LCAXN, LCBX, LCDX, LCDXN and LCCX (continued)

Thomas and Betts						Burndy			
TBM12	TBM8	TBM6, 25000	TBM6BSCR, TBM6H	TBM8-750, TBM8-750M-1	TBM14BSCR, TBM14M, TBM15	BCT500HS, Y500CT-HS	Y644M	Y35, Y39, Y750, Y46 [Ⓢ] , Y750-2, Y750BH, BAT35-14V, BAT750-14V, PAT750-18V	MRC840
Die Part Number/Color Code and Die Index Number (Number of Crimps)									
TBM12D-5 Purp/Olive 54 (1)	—	—	6TON54 Purple 54 (2)	STD (1)	15511 Purple 54 (2)	W28RT Purple 15 (2)	(1)	U28RT Purple 15 (1)	—
TBM12D-5 Purp/Olive 54 (4)	—	—	6TON54 Purple 54 (4)	STD (4)	15511 Purple 54 (4)	W28RT Purple 15 (4)	(3)	U28RT Purple 15 (3)	—
TBM12D-5 Yellow 62 (1)	—	—	6TON62 Yellow 62 (2)	STD (1)	15510-CK Yellow 62 (1)	W29RT Yellow 16 (2)	(1)	U29RT Yellow 16 (1)	—
TBM12D-5 Yellow 62 (3)	—	—	6TON62 Yellow 62 (4)	STD (4)	15510-CK Yellow 62 (2)	W29RT Yellow 16 (4)	(3)	U29RT Yellow 16 (3)	—
TBM12D-4 Red 71H [Ⓢ] (2)	—	—	6TON71 Red 71H [Ⓢ] (2)	STD (2)	15514-CK Red 71H [Ⓢ] (2)	W31RT Red 18 (2)	(1)	U31RT Red 18 (2)	—
TBM12D-4 Red 71H [Ⓢ] (4)	—	—	6TON71 Red 71H [Ⓢ] (4)	STD (4)	15514-CK Red 71H [Ⓢ] (4)	W31RT Red 18 (4)	(3)	U31RT Red 18 (4)	—
TBM12D-4 Blue 76H [Ⓢ] (2)	—	—	6TON76 Blue 76H [Ⓢ] (2)	STD (2)	15512 Blue 76H [Ⓢ] (2)	W32RT Blue 19 (3)	(1)	U32RT Blue 19 (2)	—
TBM12D-4 Blue 76H [Ⓢ] (4)	—	—	6TON76 Blue 76H [Ⓢ] (4)	STD (4)	15512 Blue 76H [Ⓢ] (4)	W32RT Blue 19 (4)	(3)	U32RT Blue 19 (4)	—
TBM12D-3 Brown 87H [Ⓢ] (2)	—	—	6TON87 Brown 87H [Ⓢ] (2)	STD (2)	15506 Brown 87H [Ⓢ] (2)	—	(1)	U34RT Brown 20 (2)	—
TBM12D-3 Brown 87H [Ⓢ] (4)	—	—	6TON87 Brown 87H [Ⓢ] (4)	STD (4)	15506 Brown 87H [Ⓢ] (4)	—	(4)	U34RT Brown 20 (4)	—
TBM12D-2 Pink 99H [Ⓢ] (2)	—	—	—	STD (2)	15505 Pink 99H [Ⓢ] (2)	—	(1)	U38XRT Pink L99 (2)	—
TBM12D-2 Pink 99H [Ⓢ] (4)	—	—	—	STD (4)	15505 Pink 99H [Ⓢ] (4)	—	(4)	U38XRT Pink L99 (4)	—
TBM12D-2 Pink 99H [Ⓢ] (2)	—	—	—	STD (2)	15505 Pink 99H [Ⓢ] (2)	—	(1)	U38RT Pink 400 (2)	—
TBM12D-2 Black 106H [Ⓢ] (2)	—	—	—	—	15515-CK Black 106H [Ⓢ] (2)	—	(1)	U39RT Black 24 (2)	—
TBM12D-1 Yellow 115H [Ⓢ] (2)	—	—	—	—	15504 Yellow 115H [Ⓢ] (2)	—	(1)	U44XRT Yellow L115 (2)	—

ⓈHalf width dies.

ⓈRequires U die adapter.

A.
System
Overview

B1.
Cable
Ties

B2.
Cable
Accessories

B3.
Stainless
Steel Ties

C1.
Wiring
Duct

C2.
Surface
Raceway

C3.
Abrasion
Protection

C4.
Cable
Management

D1.
Terminals

D2.
Power
Connectors

D3.
Grounding
Connectors

E1.
Labeling
Systems

E2.
Labels

E3.
Pre-Printed
& Write-On
Markers

E4.
Permanent
Identification

E5.
Lockout/
Tagout
& Safety
Solutions

F.
Index

A. System Overview

B1. Cable Ties

B2. Cable Accessories

B3. Stainless Steel Ties

C1. Wiring Duct

C2. Surface Raceway

C3. Abrasion Protection

C4. Cable Management

D1. Terminals

D2. Power Connectors

D3. Grounding Connectors

E1. Labeling Systems

E2. Labels

E3. Pre-Printed & Write-On Markers

E4. Permanent Identification

E5. Lockout/Tagout & Safety Solutions

F. Index

For use with Copper Conductors

Installation Tooling and Die Selections for: Types LCAF, LCCF, and SCSF

How to read this chart

For LCAF6 lug and CT-2931 crimping tool:

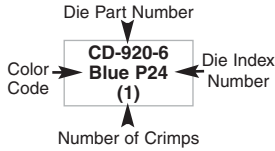

PANDUIT (See Compression Connector Tools Selection Guide, Pages D3.30 – D3.32)

CT-930, CT-930CH, CT-2930, CT-2931, CT-920, CT-920CH, CT-2920, CT-940CH^①, CT-2940^①

Die Part Number/Color Code and Die Index Number/ (Number of Crimps)

PANDUIT Part Number	Std. Wire Size	Cable Classes	Wire Strip Length (In.)	Die Part Number/Color Code and Die Index Number/ (Number of Crimps)	
				for LCAF, SCSF Parts	for LCCF Parts
LCAF8 LCCF8 SCSF8	#8 AWG	Locomotive (DLO)	13/16 11/16	CD-920-8 Red P21 (1)	
LCAF6 LCCF6 SCSF6	#6 AWG	K, M, Locomotive (DLO)	7/8 1-5/16 13/16	CD-920-6 Blue P24 (1)	CD-920-6 Blue P24 (2)
LCAF4 LCCF4 SCSF4	#4 AWG	K, M, Locomotive (DLO)	7/8 1-5/16 13/16	CD-920-4 Gray P29 (1)	CD-920-4 Gray P29 (2)
LCAF2 LCCF2 SCSF2	#2 AWG	K, M, Locomotive (DLO)	15/16 1-7/16 7/8	CD-920-2 Brown P33 (1)	CD-920-2 Brown P33 (2)
LCAF1 LCCF1 SCSF1	#1 AWG	K, M, Locomotive (DLO)	1 1-1/2 7/8	CD-920-1/0 Pink P42 (1)	CD-920-1/0 Pink P42 (2)
LCAF1/0 LCCF1/0 SCSF1/0	1/0 AWG	K, M, Locomotive (DLO)	1-7/16 1-9/16 1-3/16	CD-920-2/0 Black P45 (2)	
LCAF2/0 LCCF2/0 SCSF2/0	2/0 AWG	K, M, Locomotive (DLO)	1-7/16 1-9/16 1-3/16	CD-920-3/0 Orange P50 (2)	
LCAF3/0 LCCF3/0 SCSF3/0	3/0 AWG	K, M, Locomotive (DLO)	1-7/16 1-5/8 1-3/16	CD-920-4/0 Purple P54 (2)	
LCAF4/0 LCCF4/0 SCSF4/0	4/0 AWG	K, M, Locomotive (DLO)	1-7/16 1-11/16 1-3/16	CD-920-250 Yellow P62 (2)	

^① CD-920 dies can be used with CT-940CH and CT-2940 tools with CD-940-DA adapter.

For use with
Copper
Conductors

Installation Tooling and Die Selections for: Types LCAF, LCCF, and SCSF (continued)

**PANDUIT (See Compression Connector Tools Selection Guide,
Pages D3.30 – D3.32)**

**CT-930, CT-930CH, CT-2930,
CT-2931, CT-920, CT-920CH,
CT-2920, CT-940CH^①, CT-2940^①**

**Die Part Number/Color Code and Die Index Number/
(Number of Crimps)**

PANDUIT Part Number L = Lug S = Splice	Std. Wire Size	Cable Classes	Wire Strip Length (In.)	Die Part Number/Color Code and Die Index Number/ (Number of Crimps)	
				for LCAF, SCSF Parts	for LCCF Parts
LCAF250	250 kcmil 262.6 kcmil	K, M, Locomotive (DLO)	1-3/4	CD-920-300 White P66 (2)	CD-920-300 White P66 (3)
LCCF250			2-5/16		
SCSF250			1-3/16		
LCAF300	300 kcmil 313.1 kcmil	K, M, Locomotive (DLO)	1-3/4	CD-920-350 Red P71 (2)	CD-920-350 Red P71 (3)
LCCF300			2-3/8		
SCSF300			1-1/4		
LCAF350	350 kcmil 373.7 kcmil	K, M, Locomotive (DLO)	1-15/16	CD-920-400 Blue P76 (2)	CD-920-400 Blue P76 (3)
LCCF350			2-9/16		
SCSF350			1-1/2		
LCAF400	400 kcmil 444.4 kcmil	K, M, Locomotive (DLO)	2-1/4	CD-920-500 Brown P87 (2)	CD-920-500 Brown P87 (3)
LCCF400			2-3/4		
SCSF400			1-11/16		
LCAF500	500 kcmil 535.3 kcmil	K, M, Locomotive (DLO)	2-5/16	CD-920-500A Pink P99 (2)	CD-920-500A Pink P99 (3)
LCCF500			2-15/16		
SCSF500			1-5/8		
LCAF600 ^③	646.4 kcmil	Locomotive (DLO)	2-3/8	CD-920-750 Black P106 (2)	CD-920-750 Black P106 (3)
LCCF600 ^③			3		
SCSF600 ^③			1-5/8		
LCAF750 ^③	777.7 kcmil	Locomotive (DLO)	2-7/16	CD-940-800 ^② Orange P107 (2)	CD-940-800 ^② Orange P107 (4)
LCCF750 ^③			3-1/16		
SCSF750 ^③			1-5/8		

① CD-920 dies can be used with CT-940CH and CT-2940 tools with CD-940-DA adapter.

② CD-940 dies to be used exclusively with CT-940CH and CT-2940 tools.

③ Can only be crimped with CT-940CH and CT-2940 tools.

A.
System
Overview

B1.
Cable Ties

B2.
Cable
Accessories

B3.
Stainless
Steel Ties

C1.
Wiring
Duct

C2.
Surface
Raceway

C3.
Abrasion
Protection

C4.
Cable
Management

D1.
Terminals

D2.
Power
Connectors

D3.
Grounding
Connectors

E1.
Labeling
Systems

E2.
Labels

E3.
Pre-Printed
& Write-On
Markers

E4.
Permanent
Identification

E5.
Lockout/
Tagout
& Safety
Solutions

F.
Index

A. System Overview

B1. Cable Ties

B2. Cable Accessories

B3. Stainless Steel Ties

C1. Wiring Duct

C2. Surface Raceway

C3. Abrasion Protection

C4. Cable Management

D1. Terminals

D2. Power Connectors

D3. Grounding Connectors

E1. Labeling Systems

E2. Labels

E3. Pre-Printed & Write-On Markers

E4. Permanent Identification

E5. Lockout/Tagout & Safety Solutions

F. Index

For use with Copper Conductors

Installation Tooling and Die Selections for: Type RSC In-Line Reducing Splice

How to read this chart

For RSC4-6 splice and CT-2001 crimping tool:

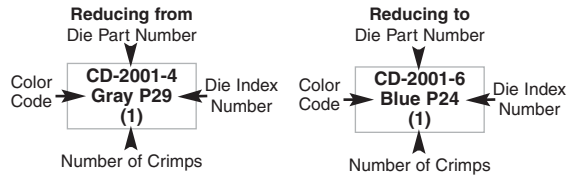

PANDUIT Part Number	Reducing From			Reducing To		
	Standard Wire Size	Cable Classes	Wire Strip Length (In.)	Standard Wire Size	Cable Classes	Wire Strip Length (In.)
RSC4-6	#4 – #3 AWG STR, #2 AWG SOL	B, C, Compact	1	#6 AWG	B, C, Compact	1-5/16
RSC2-6	#2 AWG	B, C, Compact	1	#6 AWG	B, C, Compact	1-5/16
RSC2-4	#2 AWG	B, C, Compact	1	#4 – #3 AWG STR, #2 AWG SOL	B, C, Compact	1-5/16
RSC1/0-6	1/0 AWG	B, C, Compact	1	#6 AWG	B, C, Compact	1-5/16
RSC1/0-4	1/0 AWG	B, C, Compact	1	#4 – #3 AWG STR, #2 AWG SOL	B, C, Compact	1-5/16
RSC2/0-6	2/0 AWG	B, C, Compact	1-1/16	#6 AWG	B, C, Compact	1-5/16
RSC2/0-4	2/0 AWG	B, C, Compact	1-1/16	#4 – #3 AWG STR, #2 AWG SOL	B, C, Compact	1-5/16
RSC4/0-6	4/0 AWG	B, C, Compact	1-1/16	#6 AWG	B, C, Compact	1-5/16
RSC4/0-4	4/0 AWG	B, C, Compact	1-1/16	#4 – #3 AWG STR, #2 AWG SOL	B, C, Compact	1-5/16
RSC4/0-1/0	4/0 AWG	B, C, Compact	1-1/16	1/0 AWG	B, C, Compact	1-9/16
RSC4/0-2/0	4/0 AWG	B, C, Compact	1-1/16	2/0 AWG	B, C, Compact	1-7/16
RSC500-X4/0	500 kcmil	B, C, Compact	1-7/8	4/0 AWG	I	1-7/16
RSC500-X350	500 kcmil	B, C, Compact	1-7/8	350 kcmil	I	1-7/8
RSC750-4/0	750 kcmil	B, C, Compact	2	4/0 AWG	B, C, Compact	1-5/8
RSC750-X4/0	750 kcmil	B, C, Compact	2	4/0 AWG	I	1-7/16
RSC750-X350	750 kcmil	B, C, Compact	2	350 kcmil	I	1-7/8
RSC750-500	750 kcmil	B, C, Compact	2	500 kcmil	B, C, Compact	1-7/8
RSC750-X500	750 kcmil	B, C, Compact	2	500 kcmil	I	2
RSC750-750	750 kcmil	B, C, Compact	2	750 kcmil	B, C, Compact	2
RSCX750-4/0	750 kcmil	I	2	4/0 AWG	B, C, Compact	1-5/8
RSCX750-750	750 kcmil	I	2	750 kcmil	B, C, Compact	2

For use with
Copper
Conductors

Installation Tooling and Die Selections for: Type RSC In-Line Reducing Splice (continued)

PANDUIT (See Compression Connector Tools Selection Guide, Pages D3.30 – D3.32)							
CT-1700 ^①		CT-720		CT-2001, CT-2000		CT-930 ^⑤ , CT-930CH ^⑤ , CT-920 ^⑥ , CT-920CH ^⑥ , CT-2920 ^⑥ , CT-2940 ^③ , CT-940CH ^③ , CT-2930 ^⑤ , CT-2931 ^⑤	
Reducing From	Reducing To	Reducing From	Reducing To	Reducing From	Reducing To	Reducing From	Reducing To
Die Part Number/Color Code and Die Index Number (Number of Crimps)							
Gray P29 (2)	Blue P24 (2)	CD-720-1 Gray P29 (1)	CD-720-1 Blue P24 (1)	CD-2001-4 Gray P29 (1)	CD-2001-6 Blue P24 (1)	CD-920-4 Gray P29 (1)	CD-920-6 Blue P24 (1)
Brown P33 (2)	Blue P24 (2)	CD-720-1 Brown P33 (1)	CD-720-1 Blue P24 (1)	CD-2001-2 Brown P33 (1)	CD-2001-6 Blue P24 (1)	CD-920-2 Brown P33 (1)	CD-920-6 Blue P24 (1)
Brown P33 (2)	Gray P29 (2)	CD-720-1 Brown P33 (1)	CD-720-1 Gray P29 (1)	CD-2001-2 Brown P33 (1)	CD-2001-4 Gray P29 (1)	CD-920-2 Brown P33 (1)	CD-920-4 Gray P29 (1)
—	—	CD-720-2 Pink P42 (1)	CD-720-1 Blue P24 (1)	CD-2001-1/0 Pink P42 (1)	CD-2001-6 Blue P24 (1)	CD-920-1/0 Pink P42 (1)	CD-920-6 Blue P24 (1)
—	—	CD-720-2 Pink P42 (1)	CD-720-1 Gray P29 (1)	CD-2001-1/0 Pink P42 (1)	CD-2001-4 Gray P29 (1)	CD-920-1/0 Pink P42 (1)	CD-920-4 Gray P29 (1)
—	—	CD-720-2 Black P45 (2)	CD-720-1 Blue P24 (1)	CD-2001-2/0 Black P45 (2)	CD-2001-6 Blue P24 (1)	CD-920-2/0 Black P45 (1)	CD-920-6 Blue P24 (1)
—	—	CD-720-2 Black P45 (2)	CD-720-1 Gray P29 (1)	CD-2001-2/0 Black P45 (2)	CD-2001-4 Gray P29 (1)	CD-920-2/0 Black P45 (1)	CD-920-4 Gray P29 (1)
—	—	CD-720-3 Purple P54 (2)	CD-720-1 Blue P24 (1)	CD-2001-4/0 Purple P54 (2)	CD-2001-6 Blue P24 (1)	CD-920-4/0 Purple P54 (1)	CD-920-6 Blue P24 (1)
—	—	CD-720-3 Purple P54 (2)	CD-720-1 Gray P29 (1)	CD-2001-4/0 Purple P54 (2)	CD-2001-4 Gray P29 (1)	CD-920-4/0 Purple P54 (1)	CD-920-4 Gray P29 (1)
—	—	CD-720-3 Purple P54 (2)	CD-720-2 Pink P42 (2)	CD-2001-4/0 Purple P54 (2)	CD-2001-1/0 Pink P42 (2)	CD-920-4/0 Purple P54 (1)	CD-920-1/0 Pink P42 (2)
—	—	CD-720-3 Purple P54 (2)	CD-720-2 Black P45 (2)	CD-2001-4/0 Purple P54 (2)	CD-2001-2/0 Black P45 (2)	CD-920-4/0 Purple P54 (1)	CD-920-2/0 Black P45 (2)
—	—	CD-720-7 Brown P87 (2)	CD-720-3 Yellow P62 (2)	CD-2001-500 Brown P87 (3)	CD-2001-250 Yellow P62 (2)	CD-920-500 Brown P87 (2)	CD-920-250 Yellow P62 (2)
—	—	CD-720-7 Brown P87 (2)	CD-720-6 Blue P76 (2)	CD-2001-500 Brown P87 (3)	CD-2001-400 Blue P76 (3)	CD-920-500 Brown P87 (2)	CD-920-400 Blue P76 (2)
—	—	—	—	—	—	CD-920-750, CD-940-750 ^④ Black P106 (2)	CD-920-4/0 Purple P54 (1)
—	—	—	—	—	—	CD-920-750, CD-940-750 ^④ Black P106 (2)	CD-920-250 Yellow P62 (1)
—	—	—	—	—	—	CD-920-750, CD-940-750 ^④ Black P106 (2)	CD-920-400 Blue P76 (2)
—	—	—	—	—	—	CD-920-750, CD-940-750 ^④ Black P106 (2)	CD-920-500 Brown P87 (2)
—	—	—	—	—	—	CD-920-750, CD-940-750 ^④ Black P106 (2)	CD-920-500A Pink P99 (2)
—	—	—	—	—	—	CD-920-750, CD-940-750 ^④ Black P106 (2)	CD-920-750 CD-940-750 Black P106 (2)
—	—	—	—	—	—	CD-940-750X ^④ Yellow P115 (2)	CD-920-4/0 Purple P54 (1)
—	—	—	—	—	—	CD-940-750X ^④ Yellow P115 (2)	CD-940-750 ^④ Black P106 (2)

①The CT-1700 crimp die pockets are integrated into the tool frame.
 ②CD-920 dies can be used with CT-940CH and CT-2940 tools with CD-940-DA adapter.
 ③CD-940 dies to be used with CT-940CH and CT-2940 tools.
 ④Maximum conductor size: 500 kcmil class I and 750 kcmil class I, B, C, Compact.
 ⑤Maximum conductor size: 250 kcmil class I and 400 kcmil class I, B, C, Compact.

For Burndy tooling, see pages D3.74 – D3.75
 For Thomas and Betts tooling, see pages D3.76 – D3.77

- A. System Overview
- B1. Cable Ties
- B2. Cable Accessories
- B3. Stainless Steel Ties
- C1. Wiring Duct
- C2. Surface Raceway
- C3. Abrasion Protection
- C4. Cable Management
- D1. Terminals
- D2. Power Connectors
- D3. Grounding Connectors
- E1. Labeling Systems
- E2. Labels
- E3. Pre-Printed & Write-On Markers
- E4. Permanent Identification
- E5. Lockout/Tagout & Safety Solutions
- F. Index

A.
System
Overview

B1.
Cable Ties

B2.
Cable
Accessories

B3.
Stainless
Steel Ties

C1.
Wiring
Duct

C2.
Surface
Raceway

C3.
Abrasion
Protection

C4.
Cable
Management

D1.
Terminals

D2.
Power
Connectors

D3.
Grounding
Connectors

E1.
Labeling
Systems

E2.
Labels

E3.
Pre-Printed
& Write-On
Markers

E4.
Permanent
Identification

E5.
Lockout/
Tagout/
& Safety
Solutions

F.
Index

**For use with
Copper
Conductors**

Installation Tooling and Die Selections for: Type RSC In-Line Reducing Splice (continued)

PANDUIT Part Number	Reducing From			Reducing To		
	Standard Wire Size	Cable Classes	Wire Strip Length (In.)	Standard Wire Size	Cable Classes	Wire Strip Length (In.)
RSC4-6	#4 – #3 AWG STR, #2 AWG SOL	B, C, Compact	1	#6 AWG	B, C, Compact	1-5/16
RSC2-6	#2 AWG	B, C, Compact	1	#6 AWG	B, C, Compact	1-5/16
RSC2-4	#2 AWG	B, C, Compact	1	#4 – #3 AWG STR, #2 AWG SOL	B, C, Compact	1-5/16
RSC1/0-6	1/0 AWG	B, C, Compact	1	#6 AWG	B, C, Compact	1-5/16
RSC1/0-4	1/0 AWG	B, C, Compact	1	#4 – #3 AWG STR, #2 AWG SOL	B, C, Compact	1-5/16
RSC2/0-6	2/0 AWG	B, C, Compact	1-1/16	#6 AWG	B, C, Compact	1-5/16
RSC2/0-4	2/0 AWG	B, C, Compact	1-1/16	#4 – #3 AWG STR, #2 AWG SOL	B, C, Compact	1-5/16
RSC4/0-6	4/0 AWG	B, C, Compact	1-1/16	#6 AWG	B, C, Compact	1-5/16
RSC4/0-4	4/0 AWG	B, C, Compact	1-1/16	#4 – #3 AWG STR, #2 AWG SOL	B, C, Compact	1-5/16
RSC4/0-1/0	4/0 AWG	B, C, Compact	1-1/16	1/0 AWG	B, C, Compact	1-9/16
RSC4/0-2/0	4/0 AWG	B, C, Compact	1-1/16	2/0 AWG	B, C, Compact	1-7/16
RSC500-X4/0	500 kcmil	B, C, Compact	1-7/8	4/0 AWG	I	1-7/16
RSC500-X350	500 kcmil	B, C, Compact	1-7/8	350 kcmil	I	1-7/8
RSC750-4/0	750 kcmil	B, C, Compact	2	4/0 AWG	B, C, Compact	1-5/8
RSC750-X4/0	750 kcmil	B, C, Compact	2	4/0 AWG	I	1-7/16
RSC750-X350	750 kcmil	B, C, Compact	2	350 kcmil	I	1-7/8
RSC750-500	750 kcmil	B, C, Compact	2	500 kcmil	B, C, Compact	1-7/8
RSC750-X500	750 kcmil	B, C, Compact	2	500 kcmil	I	2
RSC750-750	750 kcmil	B, C, Compact	2	750 kcmil	B, C, Compact	2
RSCX750-4/0	750 kcmil	I	2	4/0 AWG	B, C, Compact	1-5/8
RSCX750-750	750 kcmil	I	2	750 kcmil	B, C, Compact	2

For use with
Copper
Conductors

Installation Tooling and Die Selections for: Type RSC In-Line Reducing Splice (continued)

Burdny					
Y1MR, Y2MR		Y1MRTC		Y35, Y35BH, Y39, Y39BH, Y45, Y46, Y750, Y750HS, Y750-2, Y750BH-2, BAT35, BAT750, PAT644, PAT750	
Reducing From	Reducing To	Reducing From	Reducing To	Reducing From	Reducing To
Die Part Number/Color Code and Die Index Number (Number of Crimps)					
Gray (2)	Blue (3)	White (2)	Blue (3)	U4CR Gray 8 (1)	U5CRT Blue 7 (1)
Brown (2)	Blue (3)	Brown (2)	Blue (3)	U2CRT Brown 10 (1)	U5CRT Blue 7 (1)
Brown (2)	Gray (3)	Brown (2)	White (3)	U2CRT Brown 10 (1)	U4CRT Gray 8 (1)
—	—	—	—	U25RT Pink 12 (1)	U5CRT Blue 7 (1)
—	—	—	—	U25RT Pink 12 (1)	U4CRT Gray 8 (1)
—	—	—	—	U26RT Black 13 (1)	U5CRT Blue 7 (1)
—	—	—	—	U26RT Black 13 (1)	U4CRT Gray 8 (1)
—	—	—	—	U28RT Purple 15 (1)	U5CRT Blue 7 (1)
—	—	—	—	U28RT Purple 15 (1)	U4CRT Gray 8 (1)
—	—	—	—	U28RT Purple 15 (1)	U25RT Pink 12 (2)
—	—	—	—	U28RT Purple 15 (1)	U26RT Black 13 (1)
—	—	—	—	U34RT Brown 20 (2)	U29RT Yellow 16 (1)
—	—	—	—	U34RT Brown 20 (2)	U32RT Blue 19 (2)
—	—	—	—	U39RT Black 24 (3)	U28RT Purple 15 (1)
—	—	—	—	U39RT Black 24 (3)	U29RT Yellow 16 (1)
—	—	—	—	U39RT Black 24 (3)	U32RT Blue 19 (2)
—	—	—	—	U39RT Black 24 (3)	U34RT Brown 20 (2)
—	—	—	—	U39RT Black 24 (3)	U38XRT Pink L99 (3)
—	—	—	—	U39RT Black 24 (3)	U39RT Black 24 (3)
—	—	—	—	—	—
—	—	—	—	—	—

A.
System
Overview

B1.
Cable Ties

B2.
Cable
Accessories

B3.
Stainless
Steel Ties

C1.
Wiring
Duct

C2.
Surface
Raceway

C3.
Abrasion
Protection

C4.
Cable
Management

D1.
Terminals

D2.
Power
Connectors

D3.
Grounding
Connectors

E1.
Labeling
Systems

E2.
Labels

E3.
Pre-Printed
& Write-On
Markers

E4.
Permanent
Identification

E5.
Lockout/
Tagout
& Safety
Solutions

F.
Index

For PANDUIT tooling, see pages D3.72 – D3.73
For Thomas and Betts tooling, see pages D3.76 – D3.77

**For use with
Copper
Conductors**

Installation Tooling and Die Selections for: Type RSC In-Line Reducing Splice (continued)

PANDUIT Part Number	Reducing From			Reducing To		
	Standard Wire Size	Cable Classes	Wire Strip Length	Standard Wire Size	Cable Classes	Wire Strip Length
RSC4-6	#4 – #3 AWG STR #2 AWG Solid	B, C, Compact	1	6 AWG	B, C, Compact	1-5/16
RSC2-6	#2 AWG	B, C, Compact	1	6 AWG	B, C, Compact	1-5/16
RSC2-4	#2 AWG	B, C, Compact	1	4-3 AWG 2 Solid	B, C, Compact	1-5/16
RSC1/0-6	1/0 AWG	B, C, Compact	1	6 AWG	B, C, Compact	1-5/16
RSC1/0-4	1/0 AWG	B, C, Compact	1	4 – 3 AWG 2 Solid	B, C, Compact	1-5/16
RSC2/0-6	2/0 AWG	B, C, Compact	1-1/16	6 AWG	B, C, Compact	1-5/16
RSC2/0-4	2/0 AWG	B, C, Compact	1-1/16	4 – 3 AWG 2 Solid	B, C, Compact	1-5/16
RSC4/0-6	4/0 AWG	B, C, Compact	1-1/16	6 AWG	B, C, Compact	1-5/16
RSC4/0-4	4/0 AWG	B, C, Compact	1-1/16	4 – 3 AWG 2 Solid	B, C, Compact	1-5/16
RSC4/0-1/0	4/0 AWG	B, C, Compact	1-1/16	1/0 AWG	B, C, Compact	1-9/16
RSC4/0-2/0	4/0 AWG	B, C, Compact	1-1/16	2/0 AWG	B, C, Compact	1-7/16
RSC500-X4/0	500 kcmil	B, C, Compact	1-7/8	4/0 AWG	I	1-7/16
RSC500-X350	500 kcmil	B, C, Compact	1-7/8	350 kcmil	I	1-7/8
RSC750-4/0	750 kcmil	B, C, Compact	2	4/0 AWG	B, C, Compact	1-5/8
RSC750-X4/0	750 kcmil	B, C, Compact	2	4/0 AWG	I	1-7/16
RSC750-X350	750 kcmil	B, C, Compact	2	350 AWG	I	1-7/8
RSC750-500	750 kcmil	B, C, Compact	2	500 kcmil	B, C, Compact	1-7/8
RSC750-X500	750 kcmil	B, C, Compact	2	500 kcmil	I	2
RSC750-750	750 kcmil	B, C, Compact	2	750 kcmil	B, C, Compact	2
RSCX750-4/0	750 kcmil	I	2	4/0 AWG	B, C, Compact	1-5/8
RSCX750-750	750 kcmil	I	2	750 kcmil	B, C, Compact	2

For use with
Copper
Conductors

Installation Tooling and Die Selections for: Type RSC In-Line Reducing Splice (continued)

Thomas and Betts							
TBM20S, TBM25S		TBM5, TBM6, TBM8		TBM12, 13642M		TBM14BSCR, BPLT14BSCR, 13100A, TBM14M	
Reducing From	Reducing To	Reducing From	Reducing To	Reducing From	Reducing To	Reducing From	Reducing To
Color Code/Die Index Number (Number of Crimps)							
Gray 29 (2)	Blue 24 (3)	Gray 29 (1)	Blue 24 (1)	Gray 29 (1)	Blue 24 (1)	Gray 29 (1)	Blue 24 (1)
Brown 33 (2)	Blue 24 (3)	Brown 33 (1)	Blue 24 (1)	Brown 33 (1)	Blue 24 (1)	Brown 33 (1)	Blue 24 (1)
Brown 33 (2)	Gray 29 (3)	Brown 33 (1)	Gray 29 (1)	Brown 33 (1)	Gray 29 (1)	Brown 33 (1)	Gray 29 (1)
—	—	Pink 42 (1)	Blue 24 (1)	Pink 42 (1)	Blue 24 (1)	Pink 42H [®] (2)	Blue 24 (1)
—	—	Pink 42 (1)	Gray 29 (1)	Pink 42 (1)	Gray 29 (1)	Pink 42H [®] (2)	Gray 29 (1)
—	—	Black 45 (2)	Blue 24(1)	Black/Gold 45 (1)	Blue 24 (1)	Black 45 (1)	Blue 24 (1)
—	—	Black 45 (2)	Gray 29 (1)	Black/Gold 45 (1)	Gray 29 (1)	Black 45 (1)	Gray 29 (1)
—	—	Purple 54 (2)	Blue 24 (1)	Purple/Olive 54 (1)	Blue 24 (1)	Olive 54H [®] (2)	Blue 24 (1)
—	—	Purple 54 (2)	Gray 29 (1)	Purple/Olive 54 (1)	Gray 29 (1)	Olive 54H [®] (2)	Gray 29 (1)
—	—	Purple 54 (2)	Pink 42 (2)	Purple/Olive 54 (1)	Pink 42 (2)	Olive 54H [®] (2)	Pink 42H [®] (4)
—	—	Purple 54 (2)	Black 45 (2)	Purple/Olive 54 (1)	Black/Gold 45 (1)	Olive 54H [®] (2)	Black 45 (1)
—	—	—	—	Brown 87H [®] (2)	Yellow 62 (1)	Brown 87H [®] (2)	Yellow 62 (1)
—	—	—	—	Brown 87H [®] (2)	Blue 76H [®] (2)	Brown 87H [®] (2)	Blue 76 (1)
—	—	—	—	Black/Orange 106H [®] (2)	Purple/Olive 54 (1)	Black 106H [®] (2)	Olive 54H [®] (2)
—	—	—	—	Black/Orange 106H [®] (2)	Yellow 62 (1)	Black 106H [®] (2)	Yellow 62 (1)
—	—	—	—	Black/Orange 106H [®] (2)	Blue 76H [®] (2)	Black 106H [®] (2)	Blue 76 (1)
—	—	—	—	Black/Orange 106H [®] (2)	Brown 87H [®] (2)	Black 106H [®] (2)	Brown 87H [®] (2)
—	—	—	—	Black/Orange 106H [®] (2)	Pink 99H (2)	Black 106H [®] (2)	Pink 99H (2)
—	—	—	—	Black/Orange 106H [®] (2)	Black/Orange 106H [®] (2)	Black 106H [®] (2)	Black 106H [®] (2)
—	—	—	—	—	—	—	—
—	—	—	—	—	—	—	—

©Half width dies.

For PANDUIT tooling, see pages D3.72 – D3.73
For Burndy tooling, see pages D3.74 – D3.75

A.
System
Overview

B1.
Cable
Ties

B2.
Cable
Accessories

B3.
Stainless
Steel Ties

C1.
Wiring
Duct

C2.
Surface
Raceway

C3.
Abrasion
Protection

C4.
Cable
Management

D1.
Terminals

D2.
Power
Connectors

D3.
Grounding
Connectors

E1.
Labeling
Systems

E2.
Labels

E3.
Pre-Printed
& Write-On
Markers

E4.
Permanent
Identification

E5.
Lockout/
Tagout
& Safety
Solutions

F.
Index

A. System Overview

For use with Copper Conductors

Installation Tooling and Die Selections for: Type PSC

B1. Cable Ties

How to read this chart

For PSCBRN-L parallel splice and CT-2001 crimping tool:

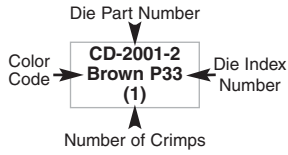

B2. Cable Accessories

B3. Stainless Steel Ties

C1. Wiring Duct

C2. Surface Raceway

C3. Abrasion Protection

C4. Cable Management

D1. Terminals

D2. Power Connectors

D3. Grounding Connectors

E1. Labeling Systems

E2. Labels

E3. Pre-Printed & Write-On Markers

E4. Permanent Identification

E5. Lockout/Tagout & Safety Solutions

F. Index

		PANDUIT Crimping Tool Part Number (See Compression Connector Tools Selection Guide, pages D3.30-D3.32)		
PANDUIT Splice Part Number	Wire Strip Length (In.)	<i>Uni-Die™</i> Dieless CT-980, CT-980CH, CT-2950, CT-2980, CT-2981	CT-2001, CT-2002	CT-920, CT-930, CT-2940*, CT-920CH, CT-930CH, CT-940CH*, CT-2920, CT-2930, CT-2931
		Die Part Number/Color Code and Die Index Number (Number of Crimps)		
PSCRED-L	7/16	—	CD-2001-8 Red P2 (1)	CD-920-8 Red P21 (1)
PSCBLU-L	7/16	—	CD-2001-6 Blue P2 (1)	CD-920-6 Blue P24 (1)
PSCGRY-L	7/16	(1)	CD-2001-4 Gray P29 (1)	CD-920-4 Gray P29 (1)
PSCBRN-L	11/16	(1)	CD-2001-2 Brown P33 (1)	CD-920-2 Brown P33 (1)
PSCGRN-L	11/16	(1)	CD-2001-1 Green P37 (1)	CD-920-1 Green P37 (1)
PSCPNK-L	11/16	(1)	CD-2001-1/0 Pink P42 (1)	CD-920-1/0 Pink P42 (1)
PSCBLK-Q	7/8	(1)	CD-2001-2/0 Black P45 (1)	CD-920-2/0 Black P45 (1)
PSCORG-Q	7/8	(1)	CD-2001-3/0 Orange P50 (1)	CD-920-3/0 Orange P50 (1)
PSCPUR-Q	1	(1)	CD-2001-4/0 Purple P54 (1)	CD-920-4/0 Purple P54 (1)
PSCYEL-Q	1 1/16	(1)	CD-2001-250 Yellow P62 (1)	CD-920-250 Yellow P62 (1)

*CD-920 dies can be used with CT-940CH and CT-2940 tools with the CD-940-DA die adapter.

For use with
Copper
Conductors

Installation Tooling and Die Selections for: Type LCMA, LCMD, and SCMS

How to read this chart

For LCMA16
lug and CT-2001
crimping tool:

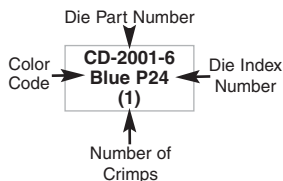

PANDUIT Tool P/N	
Color and Die Index Number (Crimps Per Wire)	
CT-2001, CT-2002 (6 Ton Hyd.)	CT-930LPCH***, (10.5 Ton Hyd.) CT-920, CT-920CH, CT-2931, CT2931/E CT-2920 (12 Ton Hyd.) CT-930, CT-930CH, CT-2930 (14 Ton Hyd.) CT-940CH*, CT-2940* (15 Ton Hyd.)
LCMA6, LCMD6	–
LCMA10, LCMD10, SCMS10	CD-2001-8 Red P21 (1)
LCMA16, LCMA16, SCMS16	CD-2001-6 Blue P24 (1)
LCMA25, LCMD25, SCMS25	CD-2001-4 Gray P29 (1)
LCMA35, LCMD35, SCMS35	CD-2001-4 Gray P29 (1)
LCMA50, LCMD50, SCMS50	CD-2001-1 Green P37 (1)
LCMA70, LCMD70, SCMS70	CD-2001-2/0 Black P45 (2)
LCMA95, LCMD95, SCMS95	CD-2001-4/0 Purple P54 (2)
LCMA120, LCMD120, SCMS120	CD-2001-250 Yellow P62 (2)
LCMA150, LCMD150, SCMS150	CD-2001-300 White P66 (2)
LCMA185, LCMD185, SCMS185	CD-2001-400 Blue P76 (2)
LCMA240, LCMD240, SCMS240	CD-2001-500 Brown P87 (2)
LCMA300, LCMD300, SCMS300	–
LCMA400, LCMD400, SCMS400	–
LCMA500, LCMD500, SCMS500	–
LCMA630, LCMD630, SCMS630	–

PANDUIT Part Number	Wire Size	Wire Type	Wire Strip Length (mm)	CT-100, CT-200, CT-1570 (Manual)	CT-600 (Air)	CT-1701 (Manual)
LCMA6, LCMD6	4-6mm ²	Class 2R	11	22-10 (1)	CT-570CH 12-10 (1)	P10 (1)
LCMA10, LCMD10, SCMS10	10mm ²	Class 2R	12	–	–	–
LCMA16, LCMA16, SCMS16	16mm ²	Class 2R	16	–	–	–
LCMA25, LCMD25, SCMS25	25mm ²	Class 2R	16.5	–	–	–
LCMA35, LCMD35, SCMS35	35mm ²	Class 2R	19	–	–	–
LCMA50, LCMD50, SCMS50	50mm ²	Class 2R	21.8	–	–	–
LCMA70, LCMD70, SCMS70	70mm ²	Class 2R	24.8	–	–	–
LCMA95, LCMD95, SCMS95	95mm ²	Class 2R	26	–	–	–
LCMA120, LCMD120, SCMS120	120mm ²	Class 2R	26	–	–	–
LCMA150, LCMD150, SCMS150	150mm ²	Class 2R	29	–	–	–
LCMA185, LCMD185, SCMS185	185mm ²	Class 2R	29.7	–	–	–
LCMA240, LCMD240, SCMS240	240mm ²	Class 2R	36.5	–	–	–
LCMA300, LCMD300, SCMS300	300mm ²	Class 2R	41.8	–	–	–
LCMA400, LCMD400, SCMS400	400mm ²	Class 2R	46.3	–	–	–
LCMA500, LCMD500, SCMS500	500mm ²	Class 2R	48	–	–	–
LCMA630, LCMD630, SCMS630	630mm ²	Class 2R	57.7	–	–	–

*CD-920 dies can be used with CT-940CH and CT-2940 tools with CD-940-DA adapter.

**CD-940 dies to be used exclusively with CT940CH and CT-2940 tools.

***Maximum size: 120mm² lugs and splices.

A. System Overview

B1. Cable Ties

B2. Cable Accessories

B3. Stainless Steel Ties

C1. Wiring Duct

C2. Surface Raceway

C3. Abrasion Protection

C4. Cable Management

D1. Terminals

D2. Power Connectors

D3. Grounding Connectors

E1. Labeling Systems

E2. Labels

E3. Pre-Printed & Write-On Markers

E4. Permanent Identification

E5. Lockout/ Tagout & Safety Solutions

F. Index

A. System Overview

B1. Cable Ties

B2. Cable Accessories

B3. Stainless Steel Ties

C1. Wiring Duct

C2. Surface Raceway

C3. Abrasion Protection

C4. Cable Management

D1. Terminals

D2. Power Connectors

D3. Grounding Connectors

E1. Labeling Systems

E2. Labels

E3. Pre-Printed & Write-On Markers

E4. Permanent Identification

E5. Lockout/Tagout & Safety Solutions

F. Index

For use with Copper or Aluminum Conductors

Installation Tooling and Die Selections for: Types LAA, LAB, and SA

How to read this chart

For LAA6 and CT-2931 crimping tool:

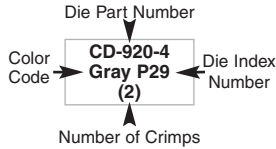

PANDUIT (See Compression Connector Tools Selection Guide, Pages D3.30 – D3.32)

PANDUIT Part Number	Std. Wire Size	Wire Strip Length (In.)	PANDUIT (See Compression Connector Tools Selection Guide, Pages D3.30 – D3.32)		
			CT-1700 ^①	CT-720	CT-930, CT-930CH, CT-920, CT-920CH, CT-2920, CT-2930, CT-2931, CT-2940 ^③ , CT-940CH ^④
L = Lugs S = Splice			Die Part Number/Color Code and Die Index Number/(Number of Crimps)		
LAA6	#6 AWG	1	Gray P29 (5)	CD-720-1 Gray P29 (2)	CD-920-4 Gray P29 (2)
SA6		3/4			
LAA4	#4 AWG	1-1/16	Green P37 (5)	CD-720-2 Green P37 (2)	CD-920-1 Green P37 (2)
SA4		7/8			
LAA2	#2 AWG	1	—	CD-720-2 Pink P42 (2)	CD-920-1/0 Pink P42 (2)
SA2		7/16			
LAA1	#1 AWG	1	—	CD-720-2 Gold P45 (3)	CD-920-2/0 Gold P45 (2)
SA1		7/16			
LAA1/0	1/0 AWG	1-9/16	—	CD-720-2 Tan P50 (3)	CD-920-3/0 Tan P50 (2)
LAB1/0		1			
SA1/0					
LAA2/0	2/0 AWG	1-9/16	—	CD-720-3 Olive P54 (3)	CD-920-4/0 Olive P54 (2)
LAB2/0		1-1/8			
SA2/0					
LAA3/0	3/0 AWG	1-9/16	—	CD-720-3 Ruby P60 (4)	CD-920-250 Ruby P60 (2)
LAB3/0		1-1/4			
SA3/0					
LAA4/0	4/0 AWG	1-3/4	—	CD-720-4 White P66 (4)	CD-920-300 White P66 (2)
LAB4/0		1-5/16			
SA4/0					
LAA250	250 kcmil	1-3/4	—	CD-720-5 Red P71 (4)	CD-920-350 Red P71 (2)
LAB250		1-7/16			
SA250					
LAA300	300 kcmil	2-5/16	—	CD-720-6 Blue P76 (4)	CD-920-400 Blue P76 (2)
LAB300		1-1/2			
SA300					
LAA350	350 kcmil	2-5/16	—	CD-720-7 Brown P87 (4)	CD-920-500 Brown P87 (2)
LAB350		1-5/8			
SA350					
LAA400	400 kcmil	2-9/16	—	—	CD-920-800 Green P94 (4)
LAB400		1-13/16			
SA400					
LAA500	500 kcmil	3-1/16	—	—	CD-920-500A Pink P99 (4)
LAB500		1-7/8			
SA500					
LAA600	600 kcmil	3-1/16	—	—	CD-920-750, CD-940-750 ^④ Black P106 (4)
LAB600		2			
SA600					
LAA750	750 kcmil	3-7/16	—	—	CD-940-750A ^④ Red P125 (4)
LAB750		2-1/4			
SA750					
LAA800	800 kcmil	3-7/16	—	—	CD-940-800A ^④ Gray P140 (4)
LAB800		2-5/16			
SA800					
LAA1000	1000 kcmil	4-3/4	—	—	CD-940-1000A ^④ Brown P161 (4)
LAB1000		2-9/16			
SA1000					

①The CT-1700 crimp die pockets are integrated into the tool frame.

③CD-920 dies can be used with CT-940CH and CT-2940 tools with CD-940-DA die adapter. Maximum size splice is 250 kcmil with CT-920, CT-920CH, and CT-2920 tools.

④CD-940 dies to be used exclusively with CT-940CH and CT-2940 tools.

For use with
Copper or
Aluminum
Conductors

Installation Tooling and Die Selections for: Types LAA, LAB, and SA (continued)

PANDUIT Part Number L = Lug S = Splice	Std. Wire Size	Wire Strip Length (In.)	Thomas and Betts			Burndy				Anderson
			TBM5	TBM8	TBM15, TBMISI, TBMISBSCR	MY29	Y35	Y39	Y45, Y46	VC8
			Die Part Number/Color Code and Die Index Number/(Number of Crimps)							
LAA6	#6 AWG	1	Gray 29	Gray 29	Gray 29	6AL	U6CABT Gray 346	U6CABT Gray 346	U6CABT Gray 346	STD
SA6		3/4	(2)	(2)	(2)	(1)	(1)	(1)	(1)	(1)
LAA4	#4 AWG	1-1/16	Green 37	Green 37	Green 37	4AL	U4CABT Green 375	U4CABT Green 375	U4CABT Green 375	STD
SA4		7/8	(2)	(2)	(2)	(1)	(1)	(1)	(1)	(1)
LAA2	#2 AWG	1	Pink 42	Pink 42	Pink 42	2AL	U2CABT Pink 348	U2CABT Pink 348	U2CABT Pink 348	STD
SA2		7/16	(3)	(3)	(2)	(1)	(2)	(2)	(2)	(1)
LAA1	#1 AWG	1	Gold 45	Gold 45	Gold 45	1AL	U1CART Gold 471	U1CART Gold 471	U1CART Gold 471	STD
SA1		7/16	(3)	(3)	(2)	(1)	(2)	(2)	(2)	(1)
LAA1/0	1/0 AWG	1-9/16	Tan 50	Tan 50	Tan 50	1/0AL	U25ART Tan 298	U25ART Tan 298	U25ART Tan 298	STD
LAB1/0		1	(3)	(3)	(2)	(1)	(2)	(2)	(2)	(2)
SA1/0										
LAA2/0	2/0 AWG	1-9/16	Olive 54	Olive 54	Olive 54	2/0AL	U26ART Olive 297	U26ART Olive 297	U26ART Olive 297	STD
LAB2/0		1-1/8	(3)	(3)	(3)	(2)	(2)	(2)	(2)	(2)
SA2/0										
LAA3/0	3/0 AWG	1-9/16	Ruby 60	Ruby 60	Ruby 60	3/0AL	U27ART Ruby 467	U27ART Ruby 467	U27ART Ruby 467	STD
LAB3/0		1-1/4	(4)	(4)	(2)	(2)	(2)	(2)	(2)	(2)
SA3/0										
LAA4/0	4/0 AWG	1-3/4	—	White 66	White 66	4/0AL	U28ART White 298	U28ART White 298	U28ART White 298	STD
LAB4/0		1-5/16	—	(4)	(2)	(2)	(2)	(2)	(2)	(2)
SA4/0										
LAA250	250 kcmil	1-3/4	—	Red 71	Red 71H [®]	—	U29ART Red 324	U29ART Red 324	U29ART Red 324	STD
LAB250		1-7/16	—	(4)	(4)	—	(2)	(2)	(2)	(2)
SA250										
LAA300	300 kcmil	2-5/16	—	Blue 76	Blue 76	—	U30ART Blue 470	U30ART Blue 470	U30ART Blue 470	STD
LAB300		1-1/2	—	(4)	(2)	—	(2)	(2)	(2)	(2)
SA300										
LAA350	350 kcmil	2-5/16	—	Brown 87	Brown 87H [®]	—	U31ART Brown 299	U31ART Brown 299	U31ART Brown 299	STD
LAB350		1-5/8	—	(4)	(4)	—	(2)	(2)	(2)	(2)
SA350										
LAA400	400 kcmil	2-9/16	—	—	Green 94H [®]	—	U32ART Green 472	U32ART Green 472	U32ART Green 472	—
LAB400		1-13/16	—	—	(4)	—	(4)	(4)	(4)	—
SA400										
LAA500	500 kcmil	3-1/16	—	—	Pink 99H [®]	—	U34ART Pink 300	U34ART Pink 300	U34ART Pink 300	—
LAB500		1-7/8	—	—	(4)	—	(4)	(4)	(4)	—
SA500										
LAA600	600 kcmil	3-1/16	—	—	Black 106	—	U36ART Black 473	U36ART Black 473	U36ART Black 473	—
LAB600		2	—	—	(3)	—	(4)	(4)	(4)	—
SA600										
LAA750	750 kcmil	3-7/16	—	—	Yellow 115H [®]	—	—	S39ART Red 301	S39ART Red 301	—
LAB750		2-1/4	—	—	(4)	—	—	(4)	(4)	—
SA750										
LAA800	800 kcmil	3-7/16	—	—	125H [®]	—	—	Gray 474	Gray 474	—
LAB800		2-5/16	—	—	(4)	—	—	(4)	(4)	—
SA800										
LAA1000	1000 kcmil	4-3/4	—	—	161	—	—	S44ART Brown 302	S44ART Brown 302	—
LAB1000		2-9/16	—	—	(5)	—	—	(4)	(4)	—
SA1000										

®Half width dies.

A.
System
Overview

B1.
Cable Ties

B2.
Cable
Accessories

B3.
Stainless
Steel Ties

C1.
Wiring
Duct

C2.
Surface
Raceway

C3.
Abrasion
Protection

C4.
Cable
Management

D1.
Terminals

D2.
Power
Connectors

D3.
Grounding
Connectors

E1.
Labeling
Systems

E2.
Labels

E3.
Pre-Printed
& Write-On
Markers

E4.
Permanent
Identification

E5.
Lockout/
Tagout
& Safety
Solutions

F.
Index

For use with
Copper or
Aluminum
Conductors

Installation Tooling and Die Selections for: Type SAR (continued)

Thomas and Betts			Burndy			Anderson
TBM5	TBM8	TBM15, TBM15I, TBM15BSCR	MY29	Y35, Y39, Y750, Y750-HS, BAT35, BAT750, PAT750, Y35BH, Y39BH, Y750BH, Y750-2, Y750BH-2	Y45, Y46	VC6
Die Part Number/Color Code and Die Index Number/ (Number of Crimps)						
Tan 50 (3)	Tan 50 (3)	Tan 50 (2)	1/0 AL (1)	U25ART Tan 296 (2)	U25ART Tan 296 (2)	STD (1)
Tan 50 (3)	Tan 50 (3)	Tan 50 (2)	1/0 AL (1)	U25ART Tan 296 (2)	U25ART Tan 296 (2)	STD (1)
—	Red 71 (4)	Red 71H ^① (4)	—	U29ART Red 324 (2)	U29ART Red 324 (2)	STD (2)
—	Red 71 (4)	Red 71H ^① (4)	—	U29ART Red 324 (2)	U29ART Red 324 (2)	STD (2)
—	Brown 87 (4)	Brown 87H ^① (4)	—	U31ART Brown 299 (2)	U31ART Brown 299 (2)	STD (2)
—	—	Pink 99H ^① (4)	—	U34ART Pink 300 (4)	U34ART Pink 300 (4)	—
—	—	Black 106 (3)	—	U36ART Black 473 (4)	U36ART Black 473 (4)	—
—	—	Yellow 115H ^① (4)	—	—	P39ART Red 301 (4)	—

①Half width dies.

A.
System
Overview

B1.
Cable Ties

B2.
Cable
Accessories

B3.
Stainless
Steel Ties

C1.
Wiring
Duct

C2.
Surface
Raceway

C3.
Abrasion
Protection

C4.
Cable
Management

D1.
Terminals

D2.
Power
Connectors

D3.
Grounding
Connectors

E1.
Labeling
Systems

E2.
Labels

E3.
Pre-Printed
& Write-On
Markers

E4.
Permanent
Identification

E5.
Lockout/
Tagout
& Safety
Solutions

F.
Index

A. System Overview

B1. Cable Ties

B2. Cable Accessories

B3. Stainless Steel Ties

C1. Wiring Duct

C2. Surface Raceway

C3. Abrasion Protection

C4. Cable Management

D1. Terminals

D2. Power Connectors

D3. Grounding Connectors

E1. Labeling Systems

E2. Labels

E3. Pre-Printed & Write-On Markers

E4. Permanent Identification

E5. Lockout/Tagout & Safety Solutions

F. Index

For use with Copper or Aluminum Conductors

Installation Tooling and Die Selections for: Type BPC

How to read this chart

For BPC6 connector and CT-2001 crimping tool:

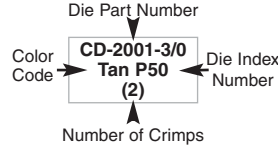

PANDUIT (See Compression Connector Tools Selection Guide, Pages D3.30 – D3.32)

PANDUIT Part Number	Standard Wire Size	Wire Strip Length (In.)	PANDUIT (See Compression Connector Tools Selection Guide, Pages D3.30 – D3.32)		
			CT-720	CT-2001, CT-2002	CT-930, CT-930CH, CT-2930, CT-2931, CT-920, CT-920CH, CT-2940 ^② , CT-2920, CT-940CH ^②
Die Part Number/Color Code and Die Index Number/(Number of Crimps)					
BPC6	#6 AWG	1-1/16	CD-720-2 Tan P50 (2)	CD-2001-3/0 Tan P50 (2)	CD-920-3/0 Tan P50 (2)
BPC4	#4 AWG	1-1/16	CD-720-2 Tan P50 (2)	CD-2001-3/0 Tan P50 (2)	CD-920-3/0 Tan P50 (2)
BPC2	#2 AWG	1-1/16	CD-720-2 Tan P50 (2)	CD-2001-3/0 Tan P50 (2)	CD-920-3/0 Tan P50 (2)
BPC1	#1 AWG	1-1/16	CD-720-2 Tan P50 (2)	CD-2001-3/0 Tan P50 (2)	CD-920-3/0 Tan P50 (2)
BPC1/0	1/0 AWG	1-5/16	CD-720-5 Red P71 (2)	CD-2001-350 Red P71 (3)	CD-920-350 Red P71 (2)
BPC2/0	2/0 AWG	1-5/16	CD-720-5 Red P71 (2)	CD-2001-350 Red P71 (3)	CD-920-350 Red P71 (2)
BPC3/0	3/0 AWG	1-5/16	CD-720-5 Red P71 (2)	CD-2001-350 Red P71 (3)	CD-920-350 Red P71 (2)
BPC4/0	4/0 AWG	1-5/16	CD-720-5 Red P71 (2)	CD-2001-350 Red P71 (3)	CD-920-350 Red P71 (2)
BPC250	250 kcmil	1-7/16	—	—	CD-920-800 Green P94 (2)
BPC300	300 kcmil	1-7/16	—	—	CD-920-800 Green P94 (2)
BPC350	350 kcmil	1-7/16	—	—	CD-920-800 Green P94 (2)
BPC400	400 kcmil	1-7/16	—	—	CD-920-750, CD-940-750 ^③ Black P106 (2)
BPC500	500 kcmil	1-7/16	—	—	CD-920-750, CD-940-750 ^③ Black P106 (2)
BPC600	600 kcmil	1-15/16	—	—	CD-940-750A ^③ Red P125 (2)
BPC750	750 kcmil	1-15/16	—	—	CD-940-750A ^③ Red P125 (2)

②CD-920 dies can be used with CT-940CH and CT-2940 tools with CD-940-DA die adapter. Maximum size splice is 250 kcmil with CT-920, CT-920CH, and CT-2920 tools.

③CD-940 dies to be used exclusively with CT-940CH and CT-2940 tools.

For use with
Copper or
Aluminum
Conductors

Installation Tooling and Die Selections for: Type BPC (continued)

Thomas and Betts			Burndy	
13642M	TBM8	TBM15, TBM15I, TBM15BSCR	Y35, BAT35	Y39, Y45, Y46, Y39BH
Die Part Number/Color Code and Die Index Number/(Number of Crimps)				
Orange 50 (2)	Tan 50 (2)	Orange 50 (2)	U25ART Tan 296 (2)	U25ART Tan 296 (2)
Orange 50 (2)	Tan 50 (2)	Orange 50 (2)	U25ART Tan 296 (2)	U25ART Tan 296 (2)
Orange 50 (2)	Tan 50 (2)	Orange 50 (2)	U25ART Tan 296 (2)	U25ART Tan 296 (2)
Orange 50 (2)	Tan 50 (2)	Orange 50 (2)	U25ART Tan 296 (2)	U25ART Tan 296 (2)
Blue 76H ^① (2)	Blue 76 (2)	Blue 76 (2)	U28ART White 298 (2)	U28ART White 298 (2)
Blue 76H ^① (2)	Blue 76 (2)	Blue 76 (2)	U28ART White 298 (2)	U28ART White 298 (2)
Blue 76H ^① (2)	Blue 76 (2)	Blue 76 (2)	U28ART White 298 (2)	U28ART White 298 (2)
Blue 76H ^① (2)	Blue 76 (2)	Blue 76 (2)	U28ART White 298 (2)	U28ART White 298 (2)
Pink 99H ^① (2)	Brown 87 (3)	Brown 87H ^① (2)	U31ART Brown 299 (2)	U31ART Brown 299 (2)
Pink 99H ^① (2)	Brown 87 (3)	Brown 87H ^① (2)	U31ART Brown 299 (2)	U31ART Brown 299 (2)
Pink 99H ^① (2)	Brown 87 (3)	Brown 87H ^① (2)	U31ART Brown 299 (2)	U31ART Brown 299 (2)
Black 106H ^① (3)	—	Black 106H ^① (3)	U34ART Pink 300 (3)	U34ART Pink 300 (3)
Black 106H ^① (3)	—	Black 106H ^① (3)	U34ART Pink 300 (3)	U34ART Pink 300 (3)
Yellow 115H ^① (3)	—	Yellow 115H ^① (3)	—	U39ART-2 Yellow 936 (3)
Yellow 115H ^① (3)	—	Yellow 115H ^① (3)	—	U39ART-2 Yellow 936 (3)

① Half width dies.

A.
System
Overview

B1.
Cable
Ties

B2.
Cable
Accessories

B3.
Stainless
Steel Ties

C1.
Wiring
Duct

C2.
Surface
Raceway

C3.
Abrasion
Protection

C4.
Cable
Management

D1.
Terminals

D2.
Power
Connectors

D3.
Grounding
Connectors

E1.
Labeling
Systems

E2.
Labels

E3.
Pre-Printed
& Write-On
Markers

E4.
Permanent
Identification

E5.
Lockout/
Tagout
& Safety
Solutions

F.
Index

A. System Overview

B1. Cable Ties

B2. Cable Accessories

B3. Stainless Steel Ties

C1. Wiring Duct

C2. Surface Raceway

C3. Abrasion Protection

C4. Cable Management

D1. Terminals

D2. Power Connectors

D3. Grounding Connectors

E1. Labeling Systems

E2. Labels

E3. Pre-Printed & Write-On Markers

E4. Permanent Identification

E5. Lockout/Tagout & Safety Solutions

F. Index

For use with Copper or Aluminum Conductors

Installation Tooling and Die Selections for: Type HTAP

How to read this chart

For HTAP2-8 tap and CT-2001 crimping tool:

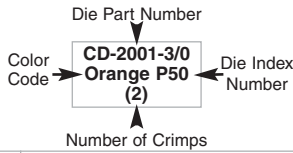

PANDUIT (See Compression Connector Tools Selection Guide, Pages D3.30 – D3.32)

PANDUIT Part Number	Conductor Sizes		CT-2001 CT-2002	CT-920, CT-920CH, CT-930, CT-930CH, CT-2920, CT-2930, CT-2931, CT-2940 ^① , CT-940CH ^①
	Run	Tap		
HTAP2-8	#2 – #6 AWG STR #1 – #6 AWG SOL	#8 – #14 AWG STR #7 – #14 AWG SOL	CD-2001-3/0 Orange P50 (2)	CD-920-3/0 (1)
HTAP1-1	#1 – #6 AWG STR #2 – #6 AWG SOL	#1 – #6 AWG STR #2 – #6 AWG SOL	CD-2001-0 Green P0 (4)	CD-920-0 (1)
HTAP1/0-1	1/0 – #6 AWG STR #2 – #6 AWG SOL	#1 – #6 AWG STR #2 – #6 AWG SOL	CD-2001-0 Green P0 (4)	CD-920-0 (1)
HTAP2/0-1	2/0 – #2 AWG STR #2 AWG SOL	#1 – #6 AWG STR #2 – #6 AWG SOL	CD-2001-0 Green P0 (4)	CD-920-0 (1)
HTAP3/0-1	3/0 – 1/0 AWG STR 4/0 – 3/0 AWG SOL	#1 – #6 AWG STR #2 – #6 AWG SOL	CD-2001-D3 ^③ (4)	CD-920-D3 (1)
HTAP3/0-3/0	3/0 – 1/0 AWG STR 4/0 – 3/0 AWG SOL	3/0 – 1/0 AWG STR 4/0 – 3/0 AWG SOL	CD-2001-D3 ^③ (5)	CD-920-D3 (1)
HTAP4/0-2	4/0 – 3/0 AWG STR	#1 – #6 AWG STR #2 – #6 AWG SOL	CD-2001-D3 ^③ (4)	CD-920-D3 (1)
HTAP4/0-3/0	4/0 – 3/0 AWG STR	3/0 – #1 AWG STR	CD-2001-D3 ^③ (6)	CD-920-D3 (1)
HTAP4/0-4/0	4/0 – 3/0 AWG STR	4/0 – 3/0 AWG STR	CD-2001-D3 ^③ (7)	CD-920-D3 (2)
HTAP500-4/0	500 kcmil STR – 4/0 AWG STR	4/0 – 1/0 AWG STR	—	CD-930-N CD-940-N ^② (3)
HTAP500-500	500 kcmil STR – 4/0 AWG STR	500 kcmil STR – 4/0 – 1/0 AWG STR	—	CD-930-N CD-940-N ^② (2)

①CD-920 and CD-930 dies can be used with CT-940CH and CT-2940 tools with CD-940-DA adapter.

②CD-940 dies to be used exclusively with CT-940CH and CT-2940 tools.

③Built into the CT-2001 crimping tool.

**For use with
Copper
Conductors**

Installation Tooling and Die Selections for: Type HTCT

**How to read
this chart**

For
HTCT6-6 tap
and CT-2931
crimping tool:

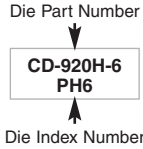

Installation Tools		
15 Ton	14 Ton	12 Ton
PANDUIT (See Compression Connector Tools Selection Guide, Pages D3.30 – D3.32)		
CT-940CH ^① , CT-2940 ^① ,	CT-930, CT-930CH, CT-2930	CT-920, CT-920CH, CT-2920, CT-2931
Burndy		
Y46 ^① , Y46C ^①	—	Y35, Y35-2, Y35BH, Y35BH-4, Y750, Y39, Y39BH, Y750-2, Y750BH, Y750BH-2, Y750HS, BAT35, BAT750, PAT750, PAT750C

Thomas and Betts		
TBM15I, TBM15BSCR	TBM14M, TBM14BSCR, BPLT14BSCR, 13100A	—

PANDUIT Part Number	Copper Conductor Sizes (Code Cable)				Copper Conductor Sizes (Flex Cable) Types G, H, I, K, M and Locomotive (DLO)				Crimp Die Color Code	PANDUIT Crimp Die Part Number/Die Index No. (Number of Crimps = 1)		
	Run	Tap 1	Tap 2	Tap 3	Main	Tap 1	Tap 2	Tap 3		TBM15I, TBM15BSCR	TBM14M, TBM14BSCR, BPLT14BSCR, 13100A	—
HTCT8-8	#8 – #14 AWG	#8 – #14 AWG	—	—	#8 – #14 AWG	#8 – #14 AWG	—	—	Green	CD-920H-8 PH8	CD-920H-8 PH8	CD-920H-8 PH8
HTCT6-6	#6 – #10 AWG	#6 – #14 AWG	—	—	#6 – #10 AWG	#6 – #14 AWG	—	—	Orange	CD-920H-6 PH6	CD-920H-6 PH6	CD-920H-6 PH6
HTCT2-2	#2 – #6 AWG	#2 – #6 AWG	#8 – #14 AWG	#8 – #14 AWG	#2 – #8 AWG	#2 – #8 AWG	#8 – #14 AWG	#8 – #14 AWG	Brown	CD-920H-2 PH2	CD-920H-2 PH2	CD-920H-2 PH2
HTCT250-8	250 kcmil – #2 AWG	#8 – #14 AWG	#8 – #14 AWG	—	4/0 – #2 AWG	#8 – #14 AWG	#8 – #14 AWG	—	Purple	CD-930H-250 PH25	CD-930H-250 PH25	CD-930H-250 PH25
HTCT250-2	250 kcmil – #2 AWG	#2 – #6 AWG	#8 – #14 AWG	—	4/0 – #2 AWG	#2 – #8 AWG	#8 – #14 AWG	—	Purple	CD-930H-250 PH25	CD-930H-250 PH25	CD-930H-250 PH25
HTCT250-250	250 kcmil – #2 AWG	250 kcmil – #2 AWG	—	—	4/0 – #2 AWG	4/0 – #2 AWG	—	—	Purple	CD-930H-250 PH25	CD-930H-250 PH25	CD-930H-250 PH25
HTCT500-250	500 kcmil – 4/0 AWG	250 kcmil – 1/0 AWG	#1 – #6 AWG STR/SOL	#8 – #14 AWG	373 kcmil – 4/0 AWG	4/0 – 1/0 AWG	#1 – #8 AWG	#8 – #14 AWG	Brown	CD-940H-500 PH50	—	—
HTCT500-500	500 – 250 kcmil	500 kcmil – 4/0 AWG	—	—	373 kcmil – 4/0 AWG	373 kcmil – 4/0 AWG	—	—	Brown	CD-940H-500 PH50	—	—
HTCT750-4/0	750 – 350 kcmil	4/0 – 1/0 AWG	#1 – #6 AWG	#2 – #14 AWG	550 – 500 kcmil	250 kcmil – 1/0 AWG	#1 – #8 AWG	#2 – #14 AWG	Yellow	CD-940H-750 PH75	—	—
HTCT750-750	750 – 500 kcmil	750 – 350 kcmil	—	—	550 – 444 kcmil	550 – 313 kcmil	—	—	Yellow	CD-940H-750 PH75	—	—
HTCT1000-250	1000 – 750 kcmil	250 kcmil – 1/0 AWG	#1 – #2 AWG	—	777 – 500 kcmil	4/0 – 1/0 AWG	#1 – #2 AWG	—	Yellow	CD-940H-750 PH75	—	—
HTCT1000-1000	1000 – 750 kcmil	1000 – 750 kcmil	—	—	777 – 750 kcmil 777 – 500 kcmil	777 – 500 kcmil 350 kcmil	—	—	White	CD-940H-1000 PH10	—	—

①CD-920H and CD-930H dies can be used with CT-940CH and CT-2940 PANDUIT tools and Y46 and Y46C Burndy tools with CD-940-DA adapter. PANDUIT crimping dies must be used with all tooling (PANDUIT and competitor) to maintain UL/CSA certifications for applications up to 600 V.

A. System Overview

B1. Cable Ties

B2. Cable Accessories

B3. Stainless Steel Ties

C1. Wiring Duct

C2. Surface Raceway

C3. Abrasion Protection

C4. Cable Management

D1. Terminals

D2. Power Connectors

D3. Grounding Connectors

E1. Labeling Systems

E2. Labels

E3. Pre-Printed & Write-On Markers

E4. Permanent Identification

E5. Lockout/Tagout & Safety Solutions

F. Index

A. System Overview

B1. Cable Ties

B2. Cable Accessories

B3. Stainless Steel Ties

C1. Wiring Duct

C2. Surface Raceway

C3. Abrasion Protection

C4. Cable Management

D1. Terminals

D2. Power Connectors

D3. Grounding Connectors

E1. Labeling Systems

E2. Labels

E3. Pre-Printed & Write-On Markers

E4. Permanent Identification

E5. Lockout/Tagout & Safety Solutions

F. Index

For use with Copper Conductors

Installation Tooling and Die Selections for: Type CTAPF

How to read this chart

For CTAPF6-12 tap and CT-2001 crimping tool:

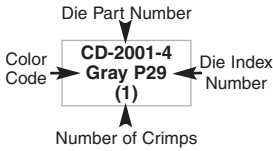

PANDUIT (See Compression Connector Tools Selection Guide, Pages D3.30 – D3.32)

PANDUIT Part Number	Stranded Wire Size		Die Part Number/Color Code and Die Index Number/ (Number of Crimps)			
	Main	Tap	1700 ^①	CT-920, CT-920CH, CT-2920, CT-930, CT-930CH, CT-2930, CT-2931, CT-940CH ^② , CT-2940 ^②	CT-2001, CT-2002	
CTAPF10-16	#14 AWG	#16 – #14 AWG	Red P21 (2)	—	—	CD-2001-8 Red P21 (1)
	#12 AWG	#16 – #12 AWG				
	#10 AWG	#14 AWG				
CTAPF8-12	#10 AWG	#10 AWG	Blue P24 (2)	—	—	CD-2001-6 Blue P24 (1)
	#8 AWG	#12 AWG				
CTAPF6-12	#8 AWG	#8 – #12 AWG	Gray P29 (2)	—	—	CD-2001-4 Gray P29 (1)
	#6 AWG	#12 – #10 AWG				
CTAPF4-12	#6 AWG	#8 – #6 AWG	Brown P33 (4)	CDM-920-2 Brown P33M (1)	CDM-2001-2 Brown P33M (1)	CD-2001-2 Brown P33 (2)
	#5, #4 AWG	#12 – #8 AWG				
CTAPF3-12	#5, #4 AWG	#6 – #5 AWG	Green P37 (4)	CDM-920-1 Green P37M (1)	CDM-2001-1 Green P37M (1)	CD-2001-1 Green P37 (2)
	#3 AWG	#12 – #6 AWG				
CTAPF2-12	#4 AWG	#4 AWG	—	CDM-920-1/0 Pink P42M (1)	CDM-2001-1/0 Pink P42M (1)	CD-2001-1/0 Pink P42 (2)
	#3 AWG	#5 AWG				
	#2 AWG	#12 – #6 AWG				
CTAPF1-12	#3 AWG	#4 – #3 AWG	—	CDM-920-2/0 Black P45M (1)	CDM-2001-2/0 Black P45M (2)	CD-2001-2/0 Black P45 (3)
	#2 AWG	#5 – #4 AWG				
	#1 AWG	#12 – #5 AWG				
CTAPF1/0-12	#2 AWG	#4 – #2 AWG	—	CDM-920-3/0 Orange P50M (1)	CDM-2001-3/0 Orange P50M (2)	CD-2001-3/0 Orange P50 (3)
	#1 AWG	#4 – #3 AWG				
	1/0 AWG	#12 – #4 AWG				
CTAPF2/0-12	#1 AWG	#2 – #1 AWG	—	CDM-920-4/0 Purple P54M (1)	—	CD-2001-4/0 Purple P54 (3)
	1/0 AWG	#3 – #2 AWG				
	2/0 AWG	#12 – #3 AWG				
CTAPF3/0-12	1/0 AWG	#1 – 1/0 AWG	—	CDM-920-250 Yellow P62M (1)	—	CD-2001-250 Yellow P62 (3)
	2/0 AWG	#2 – #1 AWG				
	3/0 AWG	#12 – #2 AWG				

①The CT-1700 crimp die pockets are integrated into the tool frame.
 ②CDM-920 dies can be used with CT-940CH and CT-2940 tools with CD-940-DA adapter.

For use with
Copper
Conductors

Installation Tooling and Die Selections for: Type CTAPF (continued)

PANDUIT Part Number	Stranded Wire Size		Burndy	Thomas and Betts	
	Run	Tap	Y35, Y39, Y45, Y46, Y750BH-2 Y750, BAT35, BAT750, Y35BH, Y39BH, Y750BH, Y750HS, PAT750, Y750-2	Y500CT-HS, BCT500-HS, BCT500, Y500CT	TBM8-750, TBM8-750M-1, TBM8-750BSCR
	Die Part Number/Color Code and Die Index Number/ (Number of Crimps)				
CTAPF10-16	#14 AWG	#16 – #14 AWG	—	—	
	#12 AWG	#16 – #12 AWG	—	—	
	#10 AWG	#14 AWG	—	—	
CTAPF8-12	#10 AWG	#10 AWG	—	—	
	#8 AWG	#12 AWG	—	—	
CTAPF6-12	#8 AWG	#8 – #12 AWG	—	—	
	#6 AWG	#12 – #10 AWG	—	—	
CTAPF4-12	#6 AWG	#8 – #6 AWG	UC4 Brown 10M (1)	WC4 Brown 10M (1)	TBM8-750C20 (1)
	#5, #4 AWG	#12 – #8 AWG	—	—	TBM8-750C2530 (1)
CTAPF3-12	#5, #4 AWG	#6 – #5 AWG	—	—	TBM8-750C2530 (1)
	#3 AWG	#12 – #6 AWG	—	—	TBM8-750C2530 (1)
CTAPF2-12	#4 AWG	#4 AWG	UC2 Pink 12M (1)	WC2 Pink 12M (1)	TBM8-750C2530 (1)
	#3 AWG	#5 AWG	—	—	TBM8-750C3540 (1)
	#2 AWG	#12 – #6 AWG	—	—	TBM8-750C3540 (1)
CTAPF1-12	#3 AWG	#4 – #3 AWG	UC1 Black 13M (1)	WC1 Black 13M (2)	TBM8-750C3540 (1)
	#2 AWG	#5 – #4 AWG	—	—	TBM8-750C3540 (1)
	#1 AWG	#12 – #5 AWG	—	—	TBM8-750C4550 (1)
CTAPF1/0-12	#2 AWG	#4 – #2 AWG	UC25 Orange 14M (1)	WC25 Orange 14M (2)	TBM8-750C4550 (1)
	#1 AWG	#4 – #3 AWG	—	—	TBM8-750C4550 (1)
	1/0 AWG	#12 – #4 AWG	—	—	TBM8-750C4550 (1)
CTAPF2/0-12	#1 AWG	#2 – #1 AWG	—	—	TBM8-750C4550 (1)
	1/0 AWG	#3 – #2 AWG	—	—	TBM8-750C4550 (1)
	2/0 AWG	#12 – #3 AWG	—	—	TBM8-750C4550 (1)
CTAPF3/0-12	1/0 AWG	#1 – 1/0 AWG	—	—	TBM8-750C4550 (1)
	2/0 AWG	#2 – #1 AWG	—	—	TBM8-750C4550 (1)
	3/0 AWG	#12 – #2 AWG	—	—	TBM8-750C4550 (1)

A.
System
Overview

B1.
Cable Ties

B2.
Cable
Accessories

B3.
Stainless
Steel Ties

C1.
Wiring
Duct

C2.
Surface
Raceway

C3.
Abrasion
Protection

C4.
Cable
Management

D1.
Terminals

D2.
Power
Connectors

D3.
Grounding
Connectors

E1.
Labeling
Systems

E2.
Labels

E3.
Pre-Printed
& Write-On
Markers

E4.
Permanent
Identification

E5.
Lockout/
Tagout
& Safety
Solutions

F.
Index

A. System Overview

B1. Cable Ties

B2. Cable Accessories

B3. Stainless Steel Ties

C1. Wiring Duct

C2. Surface Raceway

C3. Abrasion Protection

C4. Cable Management

D1. Terminals

D2. Power Connectors

D3. Grounding Connectors

E1. Labeling Systems

E2. Labels

E3. Pre-Printed & Write-On Markers

E4. Permanent Identification

E5. Lockout/Tagout & Safety Solutions

F. Index

For use with Copper Conductors

Installation Tooling and Die Selections for: Type CTAP

How to read this chart

For CTAPF4-6 tap and CT-2001 crimping tool:

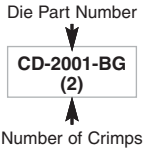

PANDUIT (See Compression Connector Tools Selection Guide, Pages D3.30 – D3.32)

Burndy

CT-920, CT-920CH, CT-930, CT-2920, CT-930CH, CT-2930, CT-2931, CT-940CH^①, CT-2940^①

CT-2001, CT-2002

MD6, MD7

BAT35, BAT750, PAT750, Y35, Y35BH, Y39, Y39BH, Y45, Y46, Y750, Y750HS, Y750BH

PANDUIT Part Number	Conductor Size		Wire Strip Length (In.)	Crimp Die Number/Index No. or Color Code/(No. of Crimps)			
	Main	Tap		PANDUIT		Burndy	
CTAP4-8	#6 – #4 AWG SOL or STR	#8 AWG SOL or STR	3/4	CD-920-BG (1)	CD-2001-BG (1)	W-BG (1) BG (2)	U-BG (1)
CTAP4-6	#6 AWG STR, #4 AWG SOL or STR	#6 AWG SOL or STR	3/4	CD-920-BG (1)	CD-2001-BG (2)	W-BG (1) BG (2)	U-BG (1)
CTAP4-4	#4 AWG SOL or STR	#4 AWG STR	3/4	CD-920-BG (1)	CD-2001-BG (1)	W-BG (1) BG (2)	U-BG (1)
CTAP2-4	#2 AWG SOL or STR	#8 – #4 AWG SOL or STR	7/8	CD-920-C (1)	CD-2001-C (2)	W-C Brown (2)	U-C (1)
CTAP2-2	#2 AWG SOL or STR	#2 AWG SOL or STR	7/8	CD-920-C (1)	CD-2001-C (2)	W-C Brown (2)	U-C (1)
CTAP2/0-2	1/0 – 2/0 AWG	#8 – #2 AWG SOL or STR	1-1/16	CD-920-0 Green (1)	—	—	U-O (1) U-E (3)
CTAP2/0-2/0	1/0 – 2/0 AWG STR	1/0 – 2/0 AWG STR	1-1/16	CD-920-0 Green (1)	—	—	U-O (1) U-E (3)
CTAP4/0-2	3/0 – 4/0 AWG STR	#6 – #2 AWG SOL or STR	1-1/4	CD-920-D3 Blue (1)	—	—	U-F (2) U-D3 (1)
CTAP4/0-2/0	3/0 – 4/0 AWG STR	1/0 – 2/0 AWG STR	1-1/4	CD-920-D3 Blue (1)	—	—	U-F (2) U-D3 (1)
CTAP4/0-4/0	3/0 – 4/0 AWG STR	3/0 – 4/0 AWG STR	1-1/4	CD-920-D3 Blue (1)	—	—	U-F (2) U-D3 (1)

①CD-920 dies can be used with CT-940CH and CT-2940 tools with CD-940-DA adapter.

NOTES

A.
System
Overview

B1.
Cable Ties

B2.
Cable
Accessories

B3.
Stainless
Steel Ties

C1.
Wiring
Duct

C2.
Surface
Raceway

C3.
Abrasion
Protection

C4.
Cable
Management

D1.
Terminals

D2.
Power
Connectors

D3.
Grounding
Connectors

E1.
Labeling
Systems

E2.
Labels

E3.
Pre-Printed
& Write-On
Markers

E4.
Permanent
Identification

E5.
Lockout/
Tagout/
& Safety
Solutions

F.
Index

A. System Overview

B1. Cable Ties

B2. Cable Accessories

B3. Stainless Steel Ties

C1. Wiring Duct

C2. Surface Raceway

C3. Abrasion Protection

C4. Cable Management

D1. Terminals

D2. Power Connectors

D3. Grounding Connectors

E1. Labeling Systems

E2. Labels

E3. Pre-Printed & Write-On Markers

E4. Permanent Identification

E5. Lockout/Tagout & Safety Solutions

F. Index

LABELING SYSTEMS

PANDUIT is a global leader in reliable and innovative solutions for identification and safety. Products are engineered for a wide variety of industries and applications – including electrical, electronics, industrial and network. *PANDUIT* provides enhanced productivity, reliability, and value with leading-edge software development, materials and equipment by designing and manufacturing a full line of labeling products, software and printers to assist you with your labeling requirements.



- World-class quality – ISO 9001 and ISO 14001
- High performance and reliability
- Wide variety of system solutions to meet the most demanding requirements
- Meet and exceed the requirements of UL, CSA, ISO, NEC and OSHA
- Strong service and support network – distributor partners, knowledgeable sales people, expert technical support and world-class customer service



PANDUIT provides a complete range of industrial products and tools – including hand-held labeling systems, desktop labeling systems, pre-printed labels and safety systems. Use *PANDUIT* for all your identification needs for wire and cable, electrical and electronic devices, agency compliance, workplace safety and more.



PRINTERS: THERMAL TRANSFER DESKTOP AND HAND-HELD

PANDUIT desktop thermal transfer printers enable fast, high quality label production for all your identification requirements. Use *PANDUIT* labeling software and desktop thermal transfer printers to produce on demand identification solutions quickly and economically. *PANDUIT* hand-held printers are designed for flexibility. Programmed with advanced functionality, *PANDUIT* printers make custom labeling easy.



Hand-Held Printers

- Create labels at remote job sites
- Provide crisp, clear, high quality thermal transfer print
- Easily identify moves, adds, or changes

Desktop Printers

- Compatible with *PANDUIT® EASY-MARK™* Labeling Software
- Provide crisp, clear, high quality thermal transfer print
- Compatible with *WINDOWS^* based PC operating systems

PANDUIT printers and our wide variety of labels provide solutions for all your project labeling needs.

^WINDOWS is a registered trademark of Microsoft Corporation in the United States and/or other countries.

A.
System
Overview

B1.
Cable Ties

B2.
Cable
Accessories

B3.
Stainless
Steel Ties

C1.
Wiring
Duct

C2.
Surface
Raceway

C3.
Abrasion
Protection

C4.
Cable
Management

D1.
Terminals

D2.
Power
Connectors

D3.
Grounding
Connectors

E1.
Labeling
Systems

E2.
Labels

E3.
Pre-Printed
& Write-On
Markers

E4.
Permanent
Identification

E5.
Lockout/
Tagout
& Safety
Solutions

F.
Index

A.
System
Overview



PANTHER™ LS8E Hand-Held Thermal Transfer Printer and Accessories

B1.
Cable Ties

- Cut-to-length functionality eliminates label waste and label trimming labor
- Partial cut feature available to provide tear-apart strips of labels
- P1™ Label Cassette contains an integrated memory device for automatic formatting, recall of last legend used, and number of labels remaining in the cassette
- Market specific labeling tools simplify label creation for electrical components, panel building, and construction and maintenance

- USB interface for importing data, system upgrades, and printing from a wireless laptop or desktop computer
- Prints self-laminating labels, heat shrink tubing, die-cut component labels and continuous tapes
- Fast loading label cassette includes both label material and ribbon to make changing labels easy
- Large graphic display with backlight for improved visibility

B2.
Cable
Accessories

B3.
Stainless
Steel Ties

C1.
Wiring
Duct

C2.
Surface
Raceway



LS8E-KIT

C3.
Abrasion
Protection

C4.
Cable
Management



LS8E

D1.
Terminals

D2.
Power
Connectors

D3.
Grounding
Connectors

E1.
Labeling
Systems

- Economical identification system provides premium quality solutions at the lowest installed cost
- Cut-to-length functionality eliminates label waste and label trimming labor
- Partial cut feature available to provide tear-apart strips of labels
- P1™ Label Cassette contains an integrated memory device for automatic formatting, recall of last legend used, and number of labels remaining in the cassette

- Prints continuous military grade heat shrink tubing
- Prints a wide variety of continuous tapes for marking of wire marking, component labeling, and safety/facility identification
- Fast loading label cassette includes both label material and ribbon to make changing labels easy

E2.
Labels

E3.
Pre-Printed
& Write-On
Markers

E4.
Permanent
Identification

E5.
Lockout/
Tagout
& Safety
Solutions



F.
Index

Part Number	Part Description	Std. Pkg. Qty.
LS8E-KIT	Includes LS8E printer, one cassette of S100X150VAC self-laminating labels, six AA alkaline batteries, LS8-CASE, LS8-PCKIT, LS8-WS, quick reference card and operator's manual.	1
LS8E	Includes LS8E printer, one cassette of S100X150VAC self-laminating labels, six AA alkaline batteries and quick reference card.	1
LS8E-ACS*	120 VAC power adapter for North America.	1
LS8-CASE	Rigid carrying case.	1
LS8-PCKIT	Includes USB cable and PC interface software for importing data, system upgrades, or printing from a wireless laptop or desktop computer.	1
LS8-IB	Protective impact bumper.	1
LS8-WS	Wrist strap.	1
LS8-CLN	Cleaning kit.	1

*Cannot be used to charge batteries.
Other adapters available, replace S with A (Australia), C (China), E (Europe) and U (UK).



COUGAR™ LS9 Hand-Held Thermal Transfer Printer and Accessories

Part Number	Part Description	Std. Pkg. Qty.
LS9	Includes LS9 printer, one cassette of T100X000VPC-BK continuous tape, six AA alkaline batteries and quick reference card.	1
LS9-ACS*	120 VAC power adapter for North America.	1
LS9-CASE	Rigid carrying case.	1
LS9-IB	Protective impact bumper.	1
LS9-WS	Wrist strap.	1
LS9-CLN	Cleaning kit.	1

*Cannot be used to charge batteries.
Other adapters available, replace S with A (Australia), C (China), E (Europe) and U (UK).



Hand-Held Thermal Transfer Printing Solutions



PANTHER™ LS8E

COUGAR™ LS9

Die-Cut Component Labels	Page E1.8	
Self-Laminating Labels	Page E1.3	
Die-Cut Heat Shrink Tubing	Page E1.7	
Continuous Heat Shrink Tubing	Page E1.6	Page E1.6
Vinyl Cloth Continuous Tapes	Page E1.5	Page E1.5
Continuous Tapes	Page E1.9	Page E1.9

P1™ Self-Laminating Label Cassettes for PANTHER™ LS8E Hand-Held Thermal Transfer Printer

- P1™ Label Cassette contains an integrated memory device for automatic formatting, recall of last legend used, and number of labels remaining in the cassette
- Fast loading label cassette includes both label material and ribbon to make changing labels easy
- Self-laminating adhesive labels for wire/cable identification include a colored print-on area and clear overlamine
- Labels are available in a large range of wire/cable sizes



Part Number System for Wire/Cable Labeling

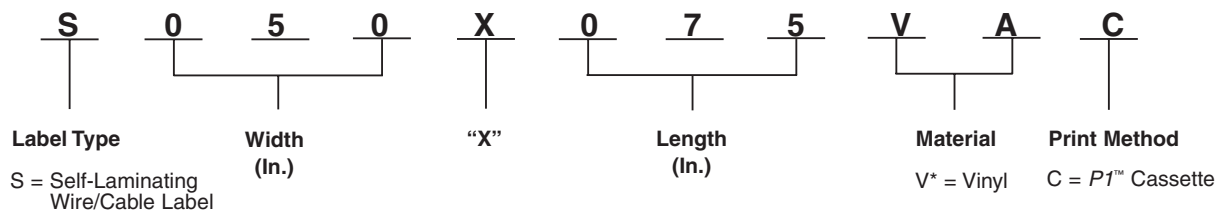

Material/Print Method Selection Chart

Material	Print Method	Temperature Range	Features
Self-Laminating Vinyl, Colored Print-On (V*)	P1™ Cassette	-40°F to 200°F (-40°C to 93°C)	Indoor/outdoor rated; thin and conformable; preferred material for most general wire/cable labeling.

Table continues on page E1.4

A. System Overview

B1. Cable Ties

B2. Cable Accessories

B3. Stainless Steel Ties

C1. Wiring Duct

C2. Surface Raceway

C3. Abrasion Protection

C4. Cable Management

D1. Terminals

D2. Power Connectors

D3. Grounding Connectors

E1. Labeling Systems

E2. Labels

E3. Pre-Printed & Write-On Markers

E4. Permanent Identification

E5. Lockout/Tagout & Safety Solutions

F. Index

A.
System
Overview

P1™ Self-Laminating Label Cassettes for PANTHER™ LS8E Hand-Held Thermal Transfer Printer (continued)

B1.
Cable Ties

B2.
Cable
Accessories

B3.
Stainless
Steel Ties

C1.
Wiring
Duct

C2.
Surface
Raceway

C3.
Abrasion
Protection

C4.
Cable
Management

D1.
Terminals

D2.
Power
Connectors

D3.
Grounding
Connectors

E1.
Labeling
Systems

E2.
Labels

E3.
Pre-Printed
& Write-On
Markers

E4.
Permanent
Identification

E5.
Lockout/
Tagout
& Safety
Solutions

F.
Index

Part Number	Part Description	Width		Length		Print-On Height		Min. Cable O.D.		Max. Cable O.D.		Std. Pkg. Qty.	Std. Ctn. Qty.
		In.	mm	In.	mm	In.	mm	In.	mm	In.	mm		
S050X075VAC	White print-on area, vinyl label for 18 – 14 AWG wires, 450/cassette.	.50	12.70	.75	19.05	.25	6.35	.08	2.02	.16	4.04	1	10
S050X125VAC	White print-on area, vinyl label for 12 – 10 AWG wires, 225/cassette.	.50	12.70	1.25	31.75	.38	9.65	.12	3.07	.28	7.03	1	10
S050X150VAC	White print-on area, vinyl label for 12 – 10 AWG wires, 225/cassette.	.50	12.70	1.50	38.10	.50	12.70	.16	4.04	.32	8.09	1	10
S075X075VAC	White print-on area, vinyl label for 18 – 14 AWG wires, 350/cassette.	.75	19.05	.75	19.05	.25	6.35	.08	2.02	.16	4.04	1	10
S075X100VAC	White print-on area, vinyl label for 12 – 10 AWG wires, 275/cassette.	.75	19.05	1.00	25.40	.38	9.65	.12	3.05	.20	5.08	1	10
S075X125VAC	White print-on area, vinyl label for 12 – 10 AWG wires, 225/cassette.	.75	19.05	1.25	31.75	.38	9.65	.12	3.07	.28	7.03	1	10
S075X150VAC	White print-on area, vinyl label for 12 – 10 AWG wires, 225/cassette.	.75	19.05	1.50	38.10	.50	12.70	.16	4.04	.32	8.09	1	10
S100X075VAC	White print-on area, vinyl label for 18 – 14 AWG wires, 350/cassette.	1.00	25.40	.75	19.05	.25	6.35	.08	2.02	.16	4.04	1	10
S100X125VAC	White print-on area, vinyl label for 12 – 10 AWG wires, 225/cassette.	1.00	25.40	1.25	31.75	.38	9.65	.12	3.07	.28	7.03	1	10
S100X150VAC	White print-on area, vinyl label for 12 – 10 AWG wires, 225/cassette.	1.00	25.40	1.50	38.10	.50	12.70	.16	4.04	.32	8.09	1	10
S100X150VBC	Blue print-on area, vinyl label for 12 – 10 AWG wires, 225/cassette.	1.00	25.40	1.50	38.10	.50	12.70	.16	4.04	.32	8.09	1	10
S100X150VDC	Green print-on area, vinyl label for 12 – 10 AWG wires, 225/cassette.	1.00	25.40	1.50	38.10	.50	12.70	.16	4.04	.32	8.09	1	10
S100X150VHC	Red print-on area, vinyl label for 12 – 10 AWG wires, 225/cassette.	1.00	25.40	1.50	38.10	.50	12.70	.16	4.04	.32	8.09	1	10
S100X150VIC	Yellow print-on area, vinyl label for 12 – 10 AWG wires, 225/cassette.	1.00	25.40	1.50	38.10	.50	12.70	.16	4.04	.32	8.09	1	10
S100X225VAC	White print-on area, vinyl label for 8 – 4 AWG wires, 125/cassette.	1.00	25.40	2.25	57.15	.75	19.05	.24	6.06	.48	12.19	1	10
S100X225VBC	Blue print-on area, vinyl label for 8 – 4 AWG wires, 125/cassette.	1.00	25.40	2.25	57.15	.75	19.05	.24	6.06	.48	12.19	1	10
S100X225VDC	Green print-on area, vinyl label for 8 – 4 AWG wires, 125/cassette.	1.00	25.40	2.25	57.15	.75	19.05	.24	6.06	.48	12.19	1	10
S100X225VHC	Red print-on area, vinyl label for 8 – 4 AWG wires, 125/cassette.	1.00	25.40	2.25	57.15	.75	19.05	.24	6.06	.48	12.19	1	10
S100X225VIC	Yellow print-on area, vinyl label for 8 – 4 AWG wires, 125/cassette.	1.00	25.40	2.25	57.15	.75	19.05	.24	6.06	.48	12.19	1	10
S100X400VAC	White print-on area, vinyl label for 2 – 1 AWG wires, 75/cassette.	1.00	25.40	4.00	101.60	1.00	25.40	.32	8.09	.95	24.26	1	10
S100X650VAC	White print-on area, vinyl label for 1/0 – 250 MCM wires, 50/cassette.	1.00	25.40	6.50	165.10	1.50	38.10	.48	12.19	1.59	40.39	1	10

Order number of cassettes required.
Other colors available, replace A with B (Blue), D (Green), H (Red) and I (Yellow).
Order number of cassettes required.

P1™ Non-Laminated Label Cassettes

- P1™ Label Cassette contains an integrated memory device for automatic formatting, recall of last legend used, and number of labels remaining in the cassette

- Fast loading label cassette includes both label material and ribbon to make changing labels easy
- Non-laminated adhesive labels for wire/cable identification



Part Number System for Wire/Cable Labeling

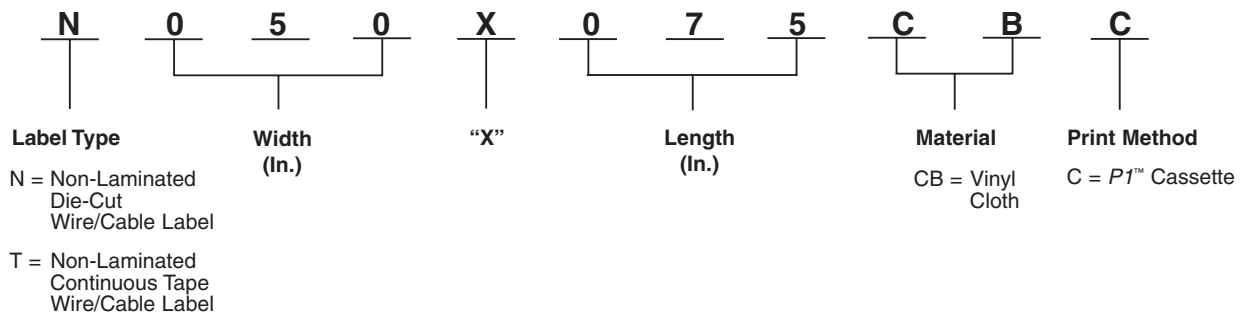

Material/Print Method Selection Chart

Material	Print Method	Temperature Range	Features
Vinyl Cloth White Print-On (CB)	P1™ Cassette	-50°F to 170°F (-46°C to 77°C)	General purpose material, vinyl impregnated cloth resists oil and abrasion; material can be removed, repositioned, and reused.

Part Number	Part Description	Height		Length		Std. Pkg. Qty.	Std. Ctn. Qty.
		In.	mm	Ft.	m		

Continuous – For Use in PANTHER™ LS8E and COUGAR™ LS9 Hand-Held Thermal Transfer Printers

T050X000CBC-BK	Black on white, vinyl cloth tape.	.50	12.70	12.5	3.8	1	10
T100X000CBC-BK	Black on white, vinyl cloth tape.	1.00	25.40	12.5	3.8	1	10

Part Number	Part Description	Width		Length		Min. Cable O.D.		Max. Cable O.D.		Std. Pkg. Qty.	Std. Ctn. Qty.
		In.	mm	In.	mm	In.	mm	In.	mm		

Die-Cut – For Use in PANTHER™ LS8E Hand-Held Thermal Transfer Printers

N050X075CBC	White, perforated vinyl cloth label for 18 – 14 AWG wires, 125/cassette.	.50	12.70	.75	19.05	.24	6.10	.51	12.95	1	10
N050X150CBC	White, perforated vinyl cloth label for Cat. 5e/Cat. 6 cable, 75/cassette.	.50	12.70	1.50	38.10	.48	12.19	1.02	25.91	1	10
N100X125CBC	White, perforated vinyl cloth label for 12 – 10 AWG wires, 75/cassette.	1.00	25.40	1.25	31.75	.40	10.16	.85	21.59	1	10
N100X150CBC	White, vinyl cloth label for Cat. 5e/Cat. 6 cable, 75/cassette.	1.00	25.40	1.50	38.10	.48	12.19	1.02	25.91	1	10
N100X175CBC	White, perforated vinyl cloth label for 8 – 4 AWG wires, 50/cassette.	1.00	25.40	1.75	44.45	.56	14.22	1.19	30.23	1	10

Order number of rolls required.

A. System Overview

P1™ Military Grade Continuous Heat Shrink Label Cassettes for *PANTHER™* LS8E or *COUGAR™* LS9 Hand-Held Thermal Transfer Printers

B1. Cable Ties

- P1™ Label Cassette contains an integrated memory device for automatic formatting, recall of last legend used, and number of labels remaining in the cassette
- Fast loading label cassette includes both label material and ribbon to make changing labels easy

- Meets print performance requirements of MIL-M-81531 and MIL-STD-202F Method 215A, Solution A, C, and D
- Meets UL Standard 224 for flammability
- Shrink ratio 3:1
- Each cassette contains a continuous roll of non-adhesive flattened polyolefin that can be cut-to-length

B2. Cable Accessories

B3. Stainless Steel Ties



C1. Wiring Duct

C2. Surface Raceway

C3. Abrasion Protection

Part Number System for Wire/Cable Labeling

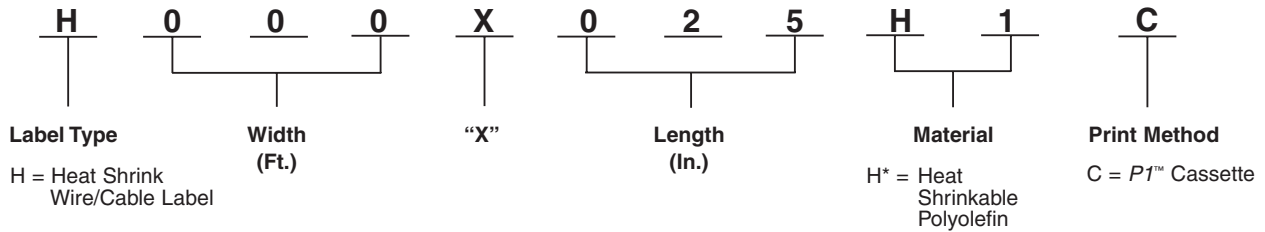

C4. Cable Management

D1. Terminals

Material/Print Method Selection Chart

Material	Print Method	Temperature Range	Features
Heat Shrinkable Polyolefin, White (H*)	P1™ Cassette	-22°F to 220°F (-30°C to 105°C)	Durable flattened polyolefin, high quality heat shrink wire/cable labels.

D2. Power Connectors

D3. Grounding Connectors

Part Number	Part Description	Width		Length		Min. Cable Diameter		Max. Cable Diameter		Std. Pkg. Qty.	Std. Ctn. Qty.
		In.	mm	Ft.	m	In.	mm	In.	mm		
H000X025H1C	White, 1/8" diameter heat shrinkable polyolefin, 22 – 16 AWG.	.25	6.35	8.0	2.44	.04	1.02	.13	3.30	1	10
H000X025H2C	Yellow, 1/8" diameter heat shrinkable polyolefin, 22 – 16 AWG.	.25	6.35	8.0	2.44	.04	1.02	.13	3.30	1	10
H000X034H1C	White, 3/16" diameter heat shrinkable polyolefin, 18 – 12 AWG.	.34	8.64	8.0	2.44	.06	1.52	.19	4.83	1	10
H000X034H2C	Yellow, 3/16" diameter heat shrinkable polyolefin, 18 – 12 AWG.	.34	8.64	8.0	2.44	.06	1.52	.19	4.83	1	10
H000X044H1C	White, 1/4" diameter heat shrinkable polyolefin, 16 – 10 AWG.	.44	11.18	6.0	1.83	.08	2.03	.25	6.35	1	10
H000X044H2C	Yellow, 1/4" diameter heat shrinkable polyolefin, 16 – 10 AWG.	.44	11.18	6.0	1.83	.08	2.03	.25	6.35	1	10
H000X084H1C	White, 1/2" diameter heat shrinkable polyolefin, 8 – 1 AWG.	.84	21.34	6.0	1.83	.17	4.32	.50	12.70	1	10
H000X084H2C	Yellow, 1/2" diameter heat shrinkable polyolefin, 8 – 1 AWG.	.84	21.34	6.0	1.83	.17	4.32	.50	12.70	1	10

Order number of cassettes required.

E1. Labeling Systems

E2. Labels

E3. Pre-Printed & Write-On Markers

E4. Permanent Identification

E5. Lockout/Tagout & Safety Solutions

F. Index

P1™ Military Grade Die-Cut Heat Shrink Label Cassettes for PANTHER™ LS8E Hand-Held Thermal Transfer Printer

- P1™ Label Cassette contains an integrated memory device for automatic formatting, recall of last legend used, and number of labels remaining in the cassette
- Fast loading label cassette includes both label material and ribbon to make changing labels easy
- Meets print performance requirements of MIL-M-81531 and MIL-STD-202F Method 215A, Solution A, C, and D
- Meets UL Standard 224 for flammability
- Shrink ratio 3:1
- Each cassette contains a roll of die-cut non-adhesive flattened polyolefin



Part Number System for Wire/Cable Labeling

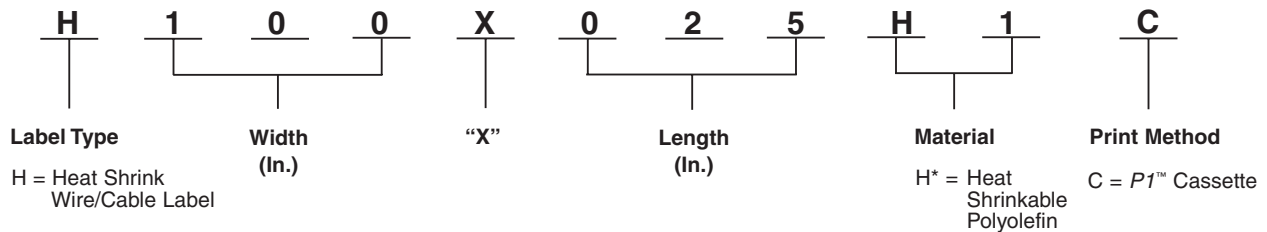

Material/Print Method Selection Chart

Material	Print Method	Temperature Range	Features
Heat Shrinkable Polyolefin (H*)	P1™ Cassette	-22°F to 220°F (-30°C to 105°C)	Durable flattened polyolefin, high quality heat shrink wire/cable labels.

Part Number	Part Description	Width		Length		Min. Cable Diameter		Max. Cable Diameter		Std. Pkg. Qty.	Std. Ctn. Qty.
		In.	mm	In.	mm	In.	mm	In.	mm		
H100X025H1C	White, 1/8" diameter heat shrinkable polyolefin, 22 – 16 AWG, 100/cassette.	.25	6.35	1.00	25.40	.04	1.02	.13	3.30	1	10
H100X025H2C	Yellow, 1/8" diameter heat shrinkable polyolefin, 22 – 16 AWG, 100/cassette.	.25	6.35	1.00	25.40	.04	1.02	.13	3.30	1	10
H100X034H1C	White, 3/16" diameter heat shrinkable polyolefin, 18 – 12 AWG, 100/cassette.	.34	8.64	1.00	25.40	.06	1.52	.19	4.83	1	10
H100X034H2C	Yellow, 3/16" diameter heat shrinkable polyolefin, 18 – 12 AWG, 100/cassette.	.34	8.64	1.00	25.40	.06	1.52	.19	4.83	1	10
H100X044H1C	White, 1/4" diameter heat shrinkable polyolefin, 16 – 10 AWG, 100/cassette.	.44	11.18	1.00	25.40	.08	2.03	.25	6.35	1	10
H100X044H2C	Yellow, 1/4" diameter heat shrinkable polyolefin, 16 – 10 AWG, 100/cassette.	.44	11.18	1.00	25.40	.08	2.03	.25	6.35	1	10
H100X084H1C	White, 1/2" diameter heat shrinkable polyolefin, 8 – 1 AWG, 75/cassette.	.84	21.34	1.00	25.40	.17	4.32	.50	12.70	1	10
H100X084H2C	Yellow, 1/2" diameter heat shrinkable polyolefin, 8 – 1 AWG, 75/cassette.	.84	21.34	1.00	25.40	.17	4.32	.50	12.70	1	10

Order number of cassettes required.

A. System Overview

P1™ General Component Label Cassettes for PANTHER™ LS8E Hand-Held Thermal Transfer Printers

B1. Cable Ties

- P1™ Label Cassette contains an integrated memory device for automatic formatting, recall of last legend used, and number of labels remaining in the cassette
- Fast loading label cassette includes both label material and ribbon to make changing labels easy

- Use for identifying flat surfaces such as components, control panels, circuit boards and general labeling
- Die-cut labels designed to provide maximum aesthetic quality and appearance
- Available in polyester and vinyl cloth materials

B2. Cable Accessories

B3. Stainless Steel Ties



C1. Wiring Duct

C2. Surface Raceway

C3. Abrasion Protection

Part Number System for Component Labeling

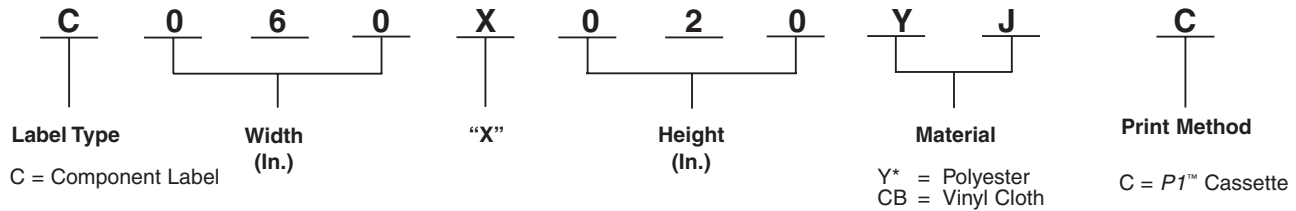

C4. Cable Management

D1. Terminals

D2. Power Connectors

D3. Grounding Connectors

Material	Print Method	Temperature Range	Features
Polyester, White (YJ) Silver (YM)	P1™ Cassette	-40°F to 302°F (-40°C to 150°C)	Indoor/outdoor rated; provides durability, high temperature resistance, and dimensional stability, does not stretch or easily tear.
Vinyl Cloth, White (CB)		-50°F to 170°F (-46°C to 77°C)	General purpose material, vinyl impregnated cloth resists oil and abrasion; material can be removed, repositioned, and reused.

E1. Labeling Systems

E2. Labels

E3. Pre-Printed & Write-On Markers

E4. Permanent Identification

E5. Lockout/Tagout & Safety Solutions

F. Index

Part Number	Part Description	Width		Height		Std. Pkg. Qty.	Std. Ctn. Qty.
		In.	mm	In.	mm		
C060X020YJC	White, polyester label, 750/cassette.	.60	15.24	.20	5.08	1	10
C100X025YJC	White, polyester label, 500/cassette.	1.00	25.40	.25	6.35	1	10
C100X050CBC	White, vinyl cloth label, 175/cassette.	1.00	25.40	.50	12.70	1	10
C100X050YJC	White, polyester label, 500/cassette.	1.00	25.40	.50	12.70	1	10
C100X050YMC	Silver, polyester label, 500/cassette.	1.00	25.40	.50	12.70	1	10
C150X075YJC	White, polyester label, 250/cassette.	1.50	38.10	.75	19.05	1	10
C200X050CBC	White, vinyl cloth label, 50/cassette.	2.00	50.80	.50	12.70	1	10
C200X050YJC	White, polyester label, 200/cassette.	2.00	50.80	.50	12.70	1	10
C200X100YJC	White, polyester label, 200/cassette.	2.00	50.80	1.00	25.40	1	10
C200X100YMC	Silver, polyester label, 150/cassette.	2.00	50.80	1.00	25.40	1	10

Order number of cassettes required.

P1™ Continuous Tape Cassettes for PANTHER™ LS8E and COUGAR™ LS9 Hand-Held Thermal Transfer Printers

- P1™ Label Cassette contains an integrated memory device for automatic formatting, recall of last legend used, and number of labels remaining in the cassette
- Fast loading label cassette includes both label material and ribbon to make changing labels easy
- Print custom pipe markers, voltage markers, signs and bin marker labels on demand
- Available in a variety of colors, widths, and adhesive materials including continuous polyolefin, polyester, and vinyl
- For flat label applications only



Part Number System for Continuous Tapes

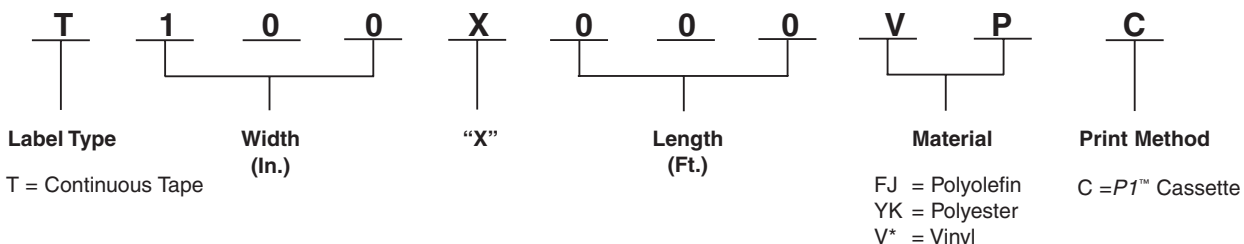

Material/Print Method Selection Chart

Material	Print Method	Temperature Range	Features
Polyolefin, White (FJ)	P1™ Cassette	-50°F to 120°F (-46°C to 49°C)	Indoor/outdoor rated; thin conformable material for general identification; excellent print quality.
Polyester, Clear (YK)		-40°F to 302°F (-40°C to 150°C)	Indoor/outdoor rated; laminated label material protects legend from abrasion and chemicals; resistant to UV light chemical atmosphere and abrasion; excellent life and adhesion properties.
Vinyl, White (VP) Blue (VQ) Green (VS) Orange (VU) Red (VW) Yellow (VX) Black (VY)		-40°F to 176°F (-40°C to 80°C)	Indoor/outdoor rated; conformable material for flat applications and safety and facility identification; can be overlaminated to increase durability.

Part Number	Part Description	Height		Length		Std. Pkg. Qty.	Std. Ctn. Qty.
		In.	mm	Ft.	m		
T019X000FJC-BK	Black on white, polyolefin module label tape.	.19	4.83	25.0	7.6	1	10
T024X000FJC-BK	Black on white, polyolefin tape, terminal block label.	.24	6.10	25.0	7.6	1	10
T031X000FJC-BK	Black on white, polyolefin tape, terminal block label.	.31	7.87	25.0	7.6	1	10
T038X000FJC-BK	Black on white, polyolefin tape, terminal block label.	.38	9.65	25.0	7.6	1	10

Order number of cassettes required.

Table continues on page E1.10

A. System Overview

B1. Cable Ties

B2. Cable Accessories

B3. Stainless Steel Ties

C1. Wiring Duct

C2. Surface Raceway

C3. Abrasion Protection

C4. Cable Management

D1. Terminals

D2. Power Connectors

D3. Grounding Connectors

E1. Labeling Systems

E2. Labels

E3. Pre-Printed & Write-On Markers

E4. Permanent Identification

E5. Lockout/Tagout & Safety Solutions

F. Index

A.
System
Overview

P1™ Continuous Tape Cassettes for *PANTHER™* LS8E and *COUGAR™* LS9 Hand-Held Thermal Transfer Printers (continued)

B1.
Cable Ties

B2.
Cable
Accessories

B3.
Stainless
Steel Ties

C1.
Wiring
Duct

C2.
Surface
Raceway

C3.
Abrasion
Protection

C4.
Cable
Management

D1.
Terminals

D2.
Power
Connectors

D3.
Grounding
Connectors

E1.
Labeling
Systems

E2.
Labels

E3.
Pre-Printed
& Write-On
Markers

E4.
Permanent
Identification

E5.
Lockout/
Tagout/
& Safety
Solutions

F.
Index

Part Number	Part Description	Height		Length		Std. Pkg. Qty.	Std. Ctn. Qty.
		In.	mm	Ft.	m		
T038X000VPC-BK	Black on white, vinyl tape.	.38	9.65	25.0	7.6	1	10
T038X000VYC-WH	White on black, vinyl tape.	.38	9.65	25.0	7.6	1	10
T038X000YKC-BK	Black on clear, polyester tape.	.38	9.65	25.0	7.6	1	10
T050X000VPC-BK	Black on white, vinyl tape.	.50	12.70	25.0	7.6	1	10
T050X000VQC-BK	Black on blue, vinyl tape.	.50	12.70	25.0	7.6	1	10
T050X000VQC-WH	White on blue, vinyl tape.	.50	12.70	25.0	7.6	1	10
T050X000VSC-BK	Black on green, vinyl tape.	.50	12.70	25.0	7.6	1	10
T050X000VSC-WH	White on green, vinyl tape.	.50	12.70	25.0	7.6	1	10
T050X000VUC-BK	Black on orange, vinyl tape.	.50	12.70	25.0	7.6	1	10
T050X000VWC-BK	Black on red, vinyl tape.	.50	12.70	25.0	7.6	1	10
T050X000VWC-WH	White on red, vinyl tape.	.50	12.70	25.0	7.6	1	10
T050X000VXC-BK	Black on yellow, vinyl tape.	.50	12.70	25.0	7.6	1	10
T050X000VYC-WH	White on black, vinyl tape.	.50	12.70	25.0	7.6	1	10
T050X000YKC-BK	Black on clear, polyester tape.	.50	12.70	25.0	7.6	1	10
T050X000YKC-WH	White on clear, polyester tape.	.50	12.70	25.0	7.6	1	10
T075X000VPC-BK	Black on white, vinyl tape.	.75	19.05	25.0	7.6	1	10
T075X000YKC-BK	Black on clear, polyester tape.	.75	19.05	25.0	7.6	1	10
T100X000VPC-BK	Black on white, vinyl tape.	1.00	25.40	25.0	7.6	1	10
T100X000VQC-BK	Black on blue, vinyl tape.	1.00	25.40	25.0	7.6	1	10
T100X000VQC-WH	White on blue, vinyl tape.	1.00	25.40	25.0	7.6	1	10
T100X000VSC-BK	Black on green, vinyl tape.	1.00	25.40	25.0	7.6	1	10
T100X000VSC-WH	White on green, vinyl tape.	1.00	25.40	25.0	7.6	1	10
T100X000VUC-BK	Black on orange, vinyl tape.	1.00	25.40	25.0	7.6	1	10
T100X000VUC-WH	White on orange, vinyl tape.	1.00	25.40	25.0	7.6	1	10
T100X000VWC-BK	Black on red, vinyl tape.	1.00	25.40	25.0	7.6	1	10
T100X000VWC-WH	White on red, vinyl tape.	1.00	25.40	25.0	7.6	1	10
T100X000VXC-BK	Black on yellow, vinyl tape.	1.00	25.40	25.0	7.6	1	10
T100X000VXC-WH	White on yellow, vinyl tape.	1.00	25.40	25.0	7.6	1	10
T100X000VYC-WH	White on black, vinyl tape.	1.00	25.40	25.0	7.6	1	10
T100X000YKC-BK	Black on clear, polyester tape.	1.00	25.40	25.0	7.6	1	10
T100X000YKC-WH	White on clear, polyester tape.	1.00	25.40	25.0	7.6	1	10

Order number of cassettes required.

TDP43MY Thermal Transfer Desktop Printer and Accessories

- Compact, lightweight design enables use in office or remote locations
- 300 dpi thermal transfer printer creates crisp, clear legends with superior legibility
- Up to 2.00 inches per second print speed for fast label production

- Use to print a wide variety of self-laminating labels, component labels, non-laminated labels, heat shrink labels, marker plates and continuous tapes up to 4.00 inches wide
- *EASY-MARK™* Labeling Software and hybrid ribbon included with printer



Part Number	Description	Std. Pkg. Qty.
TDP43MY	300 dpi printer; includes printer, <i>PANDUIT® EASY-MARK™</i> Labeling Software, RMH4BL hybrid black ribbon, AC power adapter with US and Europlug power cords, manual and quick start card.	1
TDP43M-RS	External label roll stand – used to rear feed labels that are supplied on 3.00" cores, such as photoluminescent tape.	1
TDP43M-CASE	Hardside carrying case. Accommodates printer, AC power adapter, ribbons, printer cable, labels and tools.	1
TDP43M-AC	Replacement AC power adapter with power cord (US cord only).	1
PTR-CLN	Printer cleaning kit – contains bottle of cleaning solution with MSDS, cleaning pen, swabs, alcohol wipes and cleaning instructions.	1

Ribbons for Use with the TDP43MY Thermal Transfer Desktop Printer

- **Hybrid** – Recommended for use with self-laminating, heat shrink, component and non-laminated labels
- **Wax** – Recommended for use with self-laminating and non-laminated labels

- **Resin** – Recommended for use with component labels, marker plates, and continuous tape



Part Number	Part Description	Height		Length		Std. Pkg. Qty.	Std. Ctn. Qty.
		In.	mm	Ft.	m		
RMH2BL	Black, hybrid thermal transfer ribbon. For use with self-laminating, component, heat shrink and non-laminated labels.	2.52	63.50	240.00	73.0	1	12
RMH4BL	Black, hybrid thermal transfer ribbon. For use with self-laminating, component, heat shrink and non-laminated labels.	4.33	110.00	240.00	73.0	1	12
RMW2BL	Black, wax thermal transfer ribbon. For use with self-laminating vinyl and non-laminated labels.	2.52	63.50	240.00	73.0	1	12
RMW4BL	Black, wax thermal transfer ribbon. For use with self-laminating and non-laminated labels.	4.33	110.00	240.00	73.0	1	12
RMR2BL	Black, resin thermal transfer ribbon. For use with component labels, marker plates, and continuous tape.	2.52	63.50	240.00	73.0	1	12
RMR2WH	White, resin thermal transfer ribbon. For use with component labels, marker plates, and continuous tape.	2.52	63.50	240.00	73.0	1	12
RMR4BL*	Black, resin thermal transfer ribbon. For use with component labels, marker plates, and continuous tape.	4.33	110.00	240.00	73.0	1	12

Order number of ribbons required.

*Other colors available, replace BL (Black) with WH (White), BU (Blue), GR (Green) or RD (Red).

A. System Overview

B1. Cable Ties

B2. Cable Accessories

B3. Stainless Steel Ties

C1. Wiring Duct

C2. Surface Raceway

C3. Abrasion Protection

C4. Cable Management

D1. Terminals

D2. Power Connectors

D3. Grounding Connectors

E1. Labeling Systems

E2. Labels

E3. Pre-Printed & Write-On Markers

E4. Permanent Identification

E5. Lockout/Tagout & Safety Solutions

F. Index

A. System Overview

TDP42HY, TDP43HY, TDP46HY Thermal Transfer Desktop Printers

B1. Cable Ties

- Rugged, high speed industrial printer
- 203, 305, or 609 dpi thermal transfer printers create crisp, clear legends with superior legibility
- Up to 10.00 inches per second print speed for fast label production
- Use to print a wide variety of self-laminating labels, component labels, non-laminated labels, marker plate, continuous tapes and heat shrink labels up to 4.00 inches wide
- *EASY-MARK™* Labeling Software and hybrid ribbon included with printer

B2. Cable Accessories

B3. Stainless Steel Ties



Part Number	Part Description	Std. Pkg. Qty.
TDP42HY	203 dpi printer for high volume applications, <i>PANDUIT® EASY-MARK™</i> Labeling Software, RHH4BL-S hybrid black ribbon, AC power adapter and manual.	1
TDP43HY	305 dpi printer for high volume applications, <i>PANDUIT® EASY-MARK™</i> Labeling Software, RHH4BL-S hybrid black ribbon, AC power adapter and manual.	1
TDP46HY	609 dpi printer for high volume applications, <i>PANDUIT® EASY-MARK™</i> Labeling Software, RHH4BL-S hybrid black ribbon, AC power adapter and manual.	1

C1. Wiring Duct

C2. Surface Raceway

C3. Abrasion Protection

C4. Cable Management

D1. Terminals

Ribbons for use with the TDP42HY, TDP43HY and TDP46HY Thermal Transfer Desktop Printers

D2. Power Connectors

- **Hybrid** – Recommended for use with self-laminating, heat shrink, component and non-laminated labels
- **Wax** – Recommended for use with self-laminating and non-laminated labels
- **Resin** – Recommended for use with component labels, marker plates, and continuous tape

D3. Grounding Connectors



Part Number	Part Description	Height		Length		Std. Pkg. Qty.	Std. Ctn. Qty.
		In.	mm	Ft.	m		
RHH4BL-S	Black, hybrid thermal transfer ribbon. Recommended for use with self-laminating, heat shrink, component and non-laminated labels.	4.33	109.98	1181.0	359.96	1	2
RHW4BL-S	Black, wax thermal transfer ribbon. Recommended for use with self-laminating and non-laminated labels.	4.33	109.98	1181.0	359.96	1	2
RHR4BL-S	Black, resin thermal transfer ribbon. Recommended for use with component labels and continuous tape.	4.33	109.98	1181.0	359.96	1	2

Order number of ribbons required.

E1. Labeling Systems

E2. Labels

E3. Pre-Printed & Write-On Markers

E4. Permanent Identification

E5. Lockout/Tagout & Safety Solutions

F. Index

LABELING SOFTWARE

PANDUIT labeling software is custom designed to address your requirements for wire/cable labeling, component identification, network administration, as well as, safety and facility identification. From control panel wire identification, terminal block and facility pipe marking to patch panel, faceplate and wire/cable marking, *PANDUIT* software is the solution for your on-demand identification requirements.



- *EASY-MARK™* Labeling Software is an easy-to-use, intuitive general purpose labeling software
- *CAD-CONNECT™* Labeling Software generates labels quickly and easily directly from an electronic CAD file

PANDUIT user-friendly software packages meet the unique requirements of your applications.

A.
System
Overview

B1.
Cable
Ties

B2.
Cable
Accessories

B3.
Stainless
Steel Ties

C1.
Wiring
Duct

C2.
Surface
Raceway

C3.
Abrasion
Protection

C4.
Cable
Management

D1.
Terminals

D2.
Power
Connectors

D3.
Grounding
Connectors

E1.
Labeling
Systems

E2.
Labels

E3.
Pre-Printed
& Write-On
Markers

E4.
Permanent
Identification

E5.
Lockout/
Tagout
& Safety
Solutions

F.
Index

A.
System
Overview

EASY-MARK™ Labeling Software

B1.
Cable Ties

- EASY-MARK™ Labeling Software simplifies label creation for the specific needs of your applications

- EASY-MARK™ Labeling Software is part of a complete line of innovative identification solutions from PANDUIT

B2.
Cable
Accessories

- Instructions and user interface are available in English, French, German, Italian, Spanish, Korean, Japanese, Chinese and Portuguese

- Supports most WINDOWS^ fonts drivers for standard thermal transfer, dot matrix, laser and ink jet, including PANDUIT thermal transfer printers

B3.
Stainless
Steel Ties

- Intuitive interview process allows automatic generation of labels and signs

System Requirements:

- Software selects and formats the optimum label for your specific application

- WINDOWS^ 2000, NT4.x, XP, or Vista; 64 MB hard drive space and 64 MB RAM (256 MB RAM recommended)

- **WYSIWYG** (What You See Is What You Get) user interface, alpha/numeric serialization, data import, symbol import

C1.
Wiring
Duct



Part Number	Part Description	Std. Pkg. Qty.	Std. Ctn. Qty.
PROG-EMCD3	EASY-MARK™ Labeling Software supplied on CD-ROM.	1	10

^WINDOWS is a registered trademark of Microsoft Corporation in the United States and/or other countries.

C2.
Surface
Raceway

C3.
Abrasion
Protection

CAD-CONNECT™ Labeling Software

C4.
Cable
Management

- Generates labels quickly and easily directly from electronic CAD files

- Exports to alternative formats such as EXCEL^ (XLS) or Text (CSV) files for future use and documentation

D1.
Terminals

- Eliminates steps and time spent manually copying CAD identifiers into labeling software

System Requirements:

- Program combines the power of an innovative wizard interview and EASY-MARK™ Labeling Software to capture and organize identifiers from electronic CAD files to automatically create and print labels

- WINDOWS^ 2000, NT4.x, XP, or Vista; 64 MB hard drive space and 64 MB RAM (256 MB RAM recommended)

D2.
Power
Connectors

- Compatible with full versions of AutoCAD* 2000i or newer, AutoCAD Mechanical 2007, and Visio^ 2002 or newer

D3.
Grounding
Connectors



Part Number	Part Description	Std. Pkg. Qty.	Std. Ctn. Qty.
PROG-CCCD	CAD-CONNECT™ Labeling Software, including EASY-MARK™ Labeling Software, supplied on CD-ROM.	1	10

*AutoCAD is a registered trademark of Autodesk, Inc.

^Visio, WINDOWS, and EXCEL are registered trademarks of Microsoft Corporation in the United States and/or other countries.

E1.
Labeling
Systems

E2.
Labels

E3.
Pre-Printed
& Write-On
Markers

E4.
Permanent
Identification

E5.
Lockout/
Tagout
& Safety
Solutions

F.
Index

LABELS: LASER, INK JET, THERMAL TRANSFER AND DOT MATRIX

PANDUIT provides a full line of on demand printable labels designed to meet all of your identification needs.



- Laser/ink jet labels supplied on 8.50" x 11.00" sheets and can be printed in commercially available laser and ink jet printers not sold by *PANDUIT*
- Thermal transfer labels supplied on rolls offer crisp, clear legends with superior legibility and can be printed on *PANDUIT* thermal transfer desktop printers or commercially available models
- Dot matrix labels supplied on pin feed sheets are a high quality, economical solution and can be printed on commercially available dot matrix printers not sold by *PANDUIT*
- Size illustrations are provided for reference

PANDUIT labeling solutions meet customer needs at the lowest total installed cost.

A.
System
Overview

B1.
Cable
Ties

B2.
Cable
Accessories

B3.
Stainless
Steel Ties

C1.
Wiring
Duct

C2.
Surface
Raceway

C3.
Abrasion
Protection

C4.
Cable
Management

D1.
Terminals

D2.
Power
Connectors

D3.
Grounding
Connectors

E1.
Labeling
Systems

E2.
Labels

E3.
Pre-Printed
& Write-On
Markers

E4.
Permanent
Identification

E5.
Lockout/
Tagout
& Safety
Solutions

F.
Index

A.
System
Overview

Laser/Ink Jet Self-Laminating Labels

B1.
Cable Ties



- Labels can be printed in both laser and ink jet printers
- Self-laminating adhesive labels include a colored print-on area and clear overlamine

B2.
Cable
Accessories

B3.
Stainless
Steel Ties

Part Number System for Self-Laminating Labels

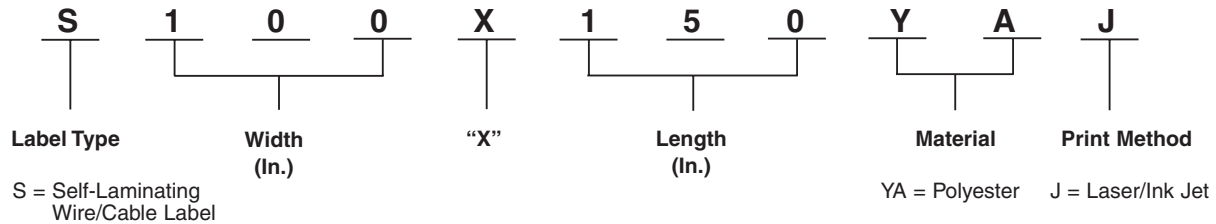

C1.
Wiring
Duct

C2.
Surface
Raceway

Material/Print Method Selection Guide

Material	Print Method	Temperature Range	Features
Self-Laminating Polyester, White Print-On (YA) Blue Print-On (YB) Green Print-On (YD) Red Print-On (YH) Yellow Print-On (YI)	Laser/Ink Jet (J)	0°F to 275°F (-18°C to 135°C)	Indoor/outdoor rated; provides durability, high temperature resistance, and dimensional stability; does not stretch or easily tear; preferred material for wire/cable labeling

C3.
Abrasion
Protection

C4.
Cable
Management

D1.
Terminals

D2.
Power
Connectors

D3.
Grounding
Connectors

E1.
Labeling
Systems

E2.
Labels

E3.
Pre-Printed
& Write-On
Markers

E4.
Permanent
Identification

E5.
Lockout/
Tagout
& Safety
Solutions

Part Number	Part Description	Width		Length		Print-On Height		Min. Cable O.D.		Max. Cable O.D.		Std. Pkg. Qty.	Std. Ctn. Qty.
		In.	mm	In.	mm	In.	mm	In.	mm	In.	mm		
S050X075YAJ	White print-on area, polyester label for 18 – 14 AWG wire.	.50	12.70	.75	19.05	.25	6.35	.12	3.03	.16	4.04	5000	25000
S050X125YAJ	White print-on area, polyester label for 12 – 10 AWG wire.	.50	12.70	1.25	31.75	.38	9.65	.12	3.03	.28	7.03	5000	25000
S050X150YAJ	White print-on area, polyester label for Cat. 5e/6 cables.	.50	12.70	1.50	38.10	.50	12.70	.16	4.07	.32	8.09	5000	25000
S075X075YAJ	White print-on area, polyester label for 18 – 14 AWG wire.	.75	19.05	.75	19.05	.25	6.35	.08	2.02	.16	4.04	2500	10000
S075X125YAJ	White print-on area, polyester label for 12 – 10 AWG wire.	.75	19.05	1.25	31.75	.38	9.65	.12	3.07	.28	7.03	2500	10000
S075X150YAJ	White print-on area, polyester label for Cat. 5e/6 cables.	.75	19.05	1.50	38.10	.50	12.70	.16	4.04	.32	8.09	2500	10000
S100X075YAJ	White print-on area, polyester label for Cat. 5e/6 cables.	.50	12.70	1.50	38.10	.50	12.70	.16	4.07	.32	8.09	5000	25000
S100X125YAJ	White print-on area, polyester label for 18 – 14 AWG wire.	1.00	25.40	.75	19.05	.25	6.35	.08	2.02	.16	4.07	2500	10000
S100X150YAJ*	White print-on area, polyester label for 12 – 10 AWG wire.	1.00	25.40	1.25	31.75	.38	9.65	.12	3.07	.28	7.03	2500	10000
S100X225YAJ*	Red print-on area, polyester label for 8 – 4 AWG wire.	1.00	25.40	2.25	57.15	.75	19.05	.24	6.06	.48	12.13	1000	5000
S100X400YAJ	White print-on area, polyester label for 2 – 1 AWG wire.	1.00	25.40	4.00	101.60	1.00	25.40	.32	8.09	.95	24.26	1000	5000
S100X650YAJ	White print-on area, polyester label for 1/0 – 350 MCM wires.	1.00	25.40	6.50	165.10	1.50	38.10	.48	12.13	1.59	40.43	1000	5000
S200X225YAJ	White print-on area, polyester label for 8 – 4 AWG wire.	2.00	50.80	2.25	57.15	.75	19.05	.24	6.06	.48	12.13	1000	5000
S200X400YAJ	White print-on area, polyester label for 2 – 1 AWG wire.	2.00	50.80	4.00	101.60	1.00	25.40	.32	8.09	.95	24.26	1000	5000
S200X650YAJ	White print-on area, polyester label for 1/0 – 350 MCM wires.	2.00	50.80	6.50	165.10	1.50	38.10	.48	12.13	1.59	40.43	500	2500

Order number of labels required in multiples of Std. Pkg. Qty.
*Other colors available, replace A with B (Blue), D (Green), H (Red) and I (Yellow).

F.
Index

Laser/Ink Jet Non-Laminated Labels

- Labels can be printed in both laser/ink jet printers
- Use as a wrap around label or flag style labels for wire/cable labeling

- Available in polyolefin material and supplied on 8.50" x 11.00" sheets
- *PANDUIT* labeling software packages include all label formats for quick and easy label production



Part Number System for Non-Laminated Labels

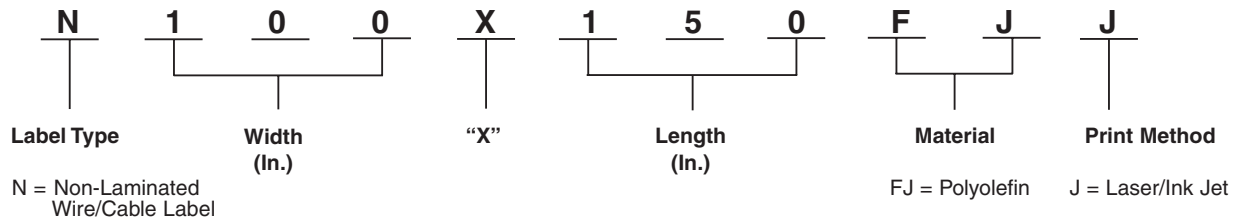

Material/Print Method Selection Guide

Material	Print Method	Temperature Range	Features
Polyolefin, White (FJ)	Laser/Ink Jet (J)	-50°F to 120°F (-46°C to 49°)	Indoor/outdoor rated; conformable material for general identification; excellent print quality

Part Number	Part Description	Width		Length		Min. Cable O.D.		Max. Cable O.D.		Std. Pkg. Qty.	Std. Ctn. Qty.
		In.	mm	In.	mm	In.	mm	In.	mm		
N025X075FJJ	White, polyolefin label.	.25	6.35	.75	19.05	.24	6.10	.51	12.95	10000	50000
N025X125FJJ	White, polyolefin label.	.25	6.35	1.25	31.75	.40	10.16	.85	21.95	10000	50000
N050X075FJJ	White, polyolefin label.	.50	12.70	.75	19.05	.24	6.10	.51	12.95	10000	50000
N050X125FJJ	White, polyolefin label.	.50	12.70	1.25	31.75	.40	10.16	.85	21.59	10000	50000
N050X150FJJ	White, polyolefin label.	.50	12.70	1.50	38.10	.48	12.19	1.02	25.91	5000	25000
N100X075FJJ	White, polyolefin label.	1.00	25.40	.75	19.05	.24	6.10	.51	12.95	5000	25000
N100X125FJJ	White, polyolefin label.	1.00	25.40	1.25	31.75	.40	10.16	.85	21.95	5000	25000
N100X150FJJ	White, polyolefin label.	1.00	25.40	1.50	38.10	.48	12.19	1.02	25.91	2500	10000

Order number of labels required in multiples of Std. Pkg. Qty.

A. System Overview

B1. Cable Ties

B2. Cable Accessories

B3. Stainless Steel Ties

C1. Wiring Duct

C2. Surface Raceway

C3. Abrasion Protection

C4. Cable Management

D1. Terminals

D2. Power Connectors

D3. Grounding Connectors

E1. Labeling Systems

E2. Labels

E3. Pre-Printed & Write-On Markers

E4. Permanent Identification

E5. Lockout/Tagout & Safety Solutions

F. Index

A. System Overview

Laser/Ink Jet Flag Style Labels

B1. Cable Ties



B2. Cable Accessories

B3. Stainless Steel Ties

C1. Wiring Duct

Part Number	Part Description	Width		Length		Min. Cable O.D.		Max. Cable O.D.		Std. Pkg. Qty.	Std. Ctn. Qty.
		In.	mm	In.	mm	In.	mm	In.	mm		
N050X150FJJ	White, polyolefin label.	.50	12.70	1.50	38.10	.06	1.52	.15	3.81	5000	25000
N100X150FJJ	White, polyolefin label.	1.00	25.40	1.50	38.10	.12	3.05	.22	5.58	2500	10000

C2. Surface Raceway

Order number of labels required in multiples of Std. Pkg. Qty.

C3. Abrasion Protection

C4. Cable Management

Laser/Ink Jet Component Labels

- Labels can be printed in both laser and ink jet printers
- Use for identifying patch panels, faceplates, punchdown blocks and other network systems hardware
- Die-cut labels designed to provide maximum aesthetic quality and appearance
- Available in adhesive polyolefin and non-adhesive polyester materials

D1. Terminals

D2. Power Connectors

D3. Grounding Connectors



E1. Labeling Systems

Part Number System for Component Labels

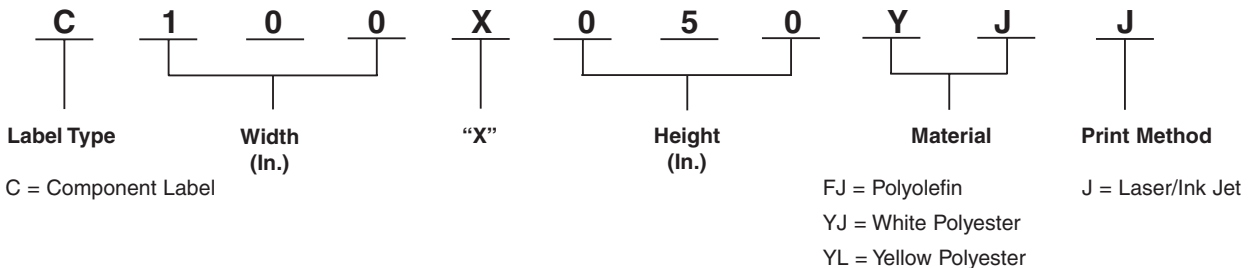

E2. Labels

E3. Pre-Printed & Write-On Markers

Material/Print Method Selection Guide

Material	Print Method	Temperature Range	Features
Polyester, White (YJ) Yellow (YL)	Laser/Ink Jet (J)	0°F to 275°F (-18°C to 135°C)	Indoor/outdoor rated; provides durability, high temperature resistance, and dimensional stability; does not stretch or easily tear
Polyolefin, White (FJ)		-50°F to 120°F (-46°C to 49°C)	Indoor/outdoor rated; thin conformable material for general identification; excellent print quality

E4. Permanent Identification

E5. Lockout/Tagout & Safety Solutions

F. Index

Laser/Ink Jet Component Labels (continued)

Part Number	Part Description	Width		Height		Std. Pkg. Qty.	Std. Ctn. Qty.
		In.	mm	In.	mm		
C038X038YJJ	White, polyester label.	.38	9.65	.38	9.65	10000	50000
C038X038YLJ	Yellow, polyester label.	.38	9.65	.38	9.65	10000	50000
C050X044YJJ	White, polyester label.	.50	12.70	.44	11.18	10000	50000
C060X020YJJ	White, polyester label.	.60	15.24	.20	5.08	10000	50000
C075X025YJJ	White, polyester label.	.75	19.05	.25	6.35	10000	50000
C075X025YLJ	Yellow, polyester label.	.75	19.05	.25	6.35	10000	50000
C080X020YJJ	White, polyester label.	.80	20.32	.20	5.08	10000	50000
C100X025YJJ	White, polyester label.	1.00	25.40	.25	6.35	10000	50000
C100X050YJJ	White, polyester label.	1.00	25.40	.50	12.70	10000	50000
C100X050YLJ	Yellow, polyester label.	1.00	25.40	.50	12.70	5000	25000
C150X075YJJ	White, polyester label.	1.50	38.10	.75	19.05	2500	12500
C160X020YJJ	White, polyester label.	1.60	40.64	.20	5.08	5000	20000
C200X050YJJ	White, polyester label.	2.00	50.80	.50	12.70	1000	5000
C200X100FJJ	White, polyolefin label, SLCT bundle marker identifier.	2.00	50.80	1.00	25.40	1000	5000
C200X100YJJ	White, polyester label.	2.00	50.80	1.00	25.40	1000	5000
C200X100YLJ	Yellow, polyester label.	2.00	50.80	1.00	25.40	1000	5000
C225X450FJJ	White, polyolefin label.	2.25	57.15	4.50	114.30	150	750
C350X500FJJ	White, polyolefin label.	3.50	88.90	5.00	127.00	100	500
C400X100YJJ	White, polyester label.	4.00	101.60	1.00	25.40	1000	5000
C400X200YJJ	White, polyester label.	4.00	101.60	2.00	50.80	1000	5000
C400X400YJJ	White, polyester label.	4.00	101.60	4.00	101.60	250	1000
C500X700FJJ	White, polyolefin label.	5.00	127.00	7.00	177.80	50	250
C850X1100YJJ	White, polyester label.	8.50	215.90	11.00	279.40	25	100
C850X1100YLJ	Yellow, polyester label.	8.50	215.90	11.00	279.40	25	100

Order number of labels required in multiples of Std. Pkg. Qty.

A.
System
Overview

B1.
Cable Ties

B2.
Cable
Accessories

B3.
Stainless
Steel Ties

C1.
Wiring
Duct

C2.
Surface
Raceway

C3.
Abrasion
Protection

C4.
Cable
Management

D1.
Terminals

D2.
Power
Connectors

D3.
Grounding
Connectors

E1.
Labeling
Systems

E2.
Labels

E3.
Pre-Printed
& Write-On
Markers

E4.
Permanent
Identification

E5.
Lockout/
Tagout
& Safety
Solutions

F.
Index

A. System Overview

Thermal Transfer Self-Laminating Labels

B1. Cable Ties

- Self-laminating adhesive labels supplied on rolls, include a colored print-on area and clear overlamine
- Use with *PANDUIT* RMH4BL hybrid thermal transfer ribbon

B2. Cable Accessories



B3. Stainless Steel Ties

C1. Wiring Duct

Material/Print Method Selection Guide

Material	Print Method	Temperature Range	Features
Self-Laminating TEDLAR®, White Print-On (TA)	Thermal Transfer (1)	-40°F to 275°F (-40°C to 135°C)	Indoor/outdoor rated; self-extinguishing; ideal for wire and cable labeling in harsh environments.
Self-Laminating Vinyl, White Print-On (VA)	Thermal Transfer (T)	-40°F to 200°F (-40°C to 93°C)	Indoor/outdoor rated; thin and conformable; preferred material for most general wire/cable labeling.

*Tedlar is a registered trademark of E. I. DuPont de Nemours Co.

C4. Cable Management

Part Number System for Self-Laminating Labels

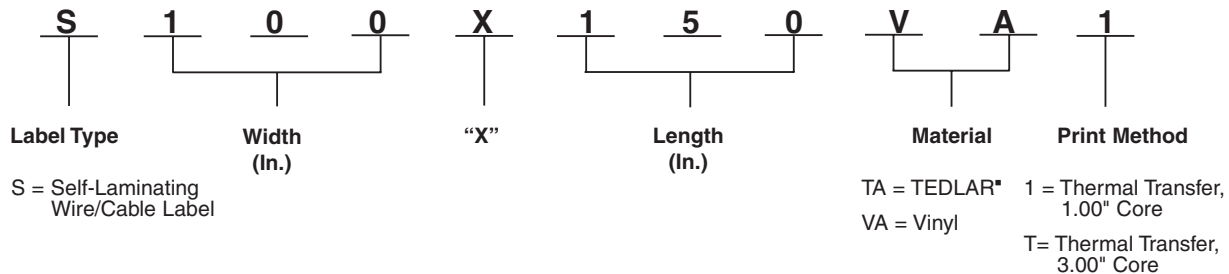

D1. Terminals

D2. Power Connectors

D3. Grounding Connectors

E1. Labeling Systems

Part Number	Part Description	Width		Length		Print-On Area Height		Min. Cable O.D.		Max. Wire O.D.		Std. Pkg. Qty.	Std. Ctn. Qty.
		In.	mm	In.	mm	In.	mm	In.	mm	In.	mm		
S050X075VA1Y	White print-on area, vinyl label for 18 – 14 AWG wires.	.50	12.70	.75	19.05	.25	6.35	.12	3.07	.16	4.04	5000	20000
S050X075VATY	White print-on area, vinyl label for 18 – 14 AWG wires.	.50	12.70	.75	19.05	.25	6.35	.12	3.07	.16	4.04	5000	40000
S050X125VA1Y	White print-on area, vinyl label for 12 – 10 AWG wires.	.50	12.70	1.25	31.75	.38	9.65	.12	3.07	.28	7.03	5000	20000
S050X125VATY	White print-on area, vinyl label for 12 – 10 AWG wires.	.50	12.70	1.25	31.75	.38	9.65	.12	3.07	.28	7.03	5000	10000
S050X150VA1Y	White print-on area, vinyl label.	.50	12.70	1.50	38.10	.50	12.70	.16	4.04	.32	8.09	5000	60000
S050X150VATY	White print-on area, vinyl label for Cat. 5e/Cat. 6 cables.	.50	12.70	1.50	38.10	.50	12.70	.16	4.04	.32	8.09	5000	40000
S075X075VATY	White print-on area, vinyl label for 18 – 14 AWG wires.	.75	19.05	.75	19.05	.25	6.35	.12	3.07	.16	4.04	5000	20000

*TEDLAR is a registered trademark of E.I. du Pont de Nemours and Company.

Order number of labels required in multiples of Std. Pkg. Qty.

Use with *PANDUIT* thermal transfer hybrid or wax ribbons.

Labels are roll mounted on 3.00" cores; when using the TDP43MY printer and 3.00" cores, the roll stand (TDP43M-RS) is required.

F. Index

Thermal Transfer Self-Laminating Labels (continued)

Part Number	Part Description	Width		Length		Print-On Area Height		Min. Cable O.D.		Max. Wire O.D.		Std. Pkg. Qty.	Std. Ctn. Qty.
		In.	mm	In.	mm	In.	mm	In.	mm	In.	mm		
S075X125VATY	White print-on area, vinyl label for 12 – 10 AWG wires.	.75	19.05	1.25	31.75	.38	9.65	.12	3.07	.28	7.03	5000	20000
S075X150VATY	White print-on area, vinyl label for Cat. 5e/Cat. 6 cables.	.75	19.05	1.50	38.10	.50	12.70	.16	4.04	.32	8.09	5000	20000
S100X075TAT	White print-on area, TEDLAR® label for 18 – 14 AWG wires.	1.00	25.40	.75	19.05	.25	6.35	.08	2.02	.16	4.04	2500	10000
S100X075VA1Y	White print-on area, vinyl label for 18 – 14 AWG wires.	1.00	25.40	.75	19.05	.25	6.35	.08	2.02	.16	4.04	2500	10000
S100X075VATY	White print-on area, vinyl label for 18 – 14 AWG wires.	1.00	25.40	.75	19.05	.25	6.35	.08	2.02	.16	4.04	5000	10000
S100X125TAT	White print-on area, TEDLAR® label for 12 – 10 AWG wires.	1.00	25.40	1.25	31.75	.38	9.65	.12	3.07	.28	7.03	2500	10000
S100X125VA1Y	White print-on area, vinyl label.	1.00	25.40	1.25	31.75	.38	9.65	.12	3.07	.28	7.03	2500	10000
S100X125VATY	White print-on area, vinyl label for 12 – 10 AWG wires.	1.00	25.40	1.25	31.75	.38	9.65	.12	3.07	.28	7.03	5000	10000
S100X150TAT	White print-on area, TEDLAR® label for Cat. 5e/Cat. 6 cables.	1.00	25.40	1.50	38.10	.50	12.70	.16	4.04	.32	8.09	2500	10000
S100X150VA1Y	White print-on area, vinyl label for Cat. 5e/Cat. 6 cables.	1.00	25.40	1.50	38.10	.50	12.70	.16	4.04	.32	8.09	2500	30000
S100X150VATY	White print-on area, vinyl label for Cat. 5e/Cat. 6 cables.	1.00	25.40	1.50	38.10	.50	12.70	.16	4.04	.32	8.09	5000	20000
S100X150VBTY	Blue print-on area, vinyl label for Cat. 5e/Cat. 6 cables.	1.00	25.40	1.50	38.10	.50	12.70	.16	4.04	.32	8.09	5000	20000
S100X150VCTY	Brown print-on area, vinyl label for Cat. 5e/Cat. 6 cables.	1.00	25.40	1.50	38.10	.50	12.70	.16	4.04	.32	8.09	5000	20000
S100X150VDTY	Green print-on area, vinyl label for Cat. 5e/Cat. 6 cables.	1.00	25.40	1.50	38.10	.50	12.70	.16	4.04	.32	8.09	5000	20000
S100X150VETY	Gray print-on area, vinyl label for Cat. 5e/Cat. 6 cables.	1.00	25.40	1.50	38.10	.50	12.70	.16	4.04	.32	8.09	5000	20000
S100X150VFTY	Orange print-on area, vinyl label for Cat. 5e/Cat. 6 cables.	1.00	25.40	1.50	38.10	.50	12.70	.16	4.04	.32	8.09	5000	20000
S100X150VGTY	Purple print-on area, vinyl label for Cat. 5e/Cat. 6 cables.	1.00	25.40	1.50	38.10	.50	12.70	.16	4.04	.32	8.09	5000	20000
S100X150VHTY	Red print-on area, vinyl label for Cat. 5e/Cat. 6 cables.	1.00	25.40	1.50	38.10	.50	12.70	.16	4.04	.32	8.09	5000	20000
S100X150VITY	Yellow print-on area, vinyl label for Cat. 5e/Cat. 6 cables.	1.00	25.40	1.50	38.10	.50	12.70	.16	4.04	.32	8.09	5000	20000
S100X150V0TY	Black print-on area, vinyl label for Cat. 5e/Cat. 6 cables.	1.00	25.40	1.50	38.10	.50	12.70	.16	4.04	.32	8.09	5000	20000
S100X150V9TY	Gold print-on area, vinyl label for Cat. 5e/Cat. 6 cables.	1.00	25.40	1.50	38.10	.50	12.70	.16	4.04	.32	8.09	5000	20000
S100X225TAT	White print-on area, TEDLAR® label for 8 – 4 AWG wires.	1.00	25.40	2.25	57.15	.75	19.05	.24	6.06	.48	12.13	1500	6000
S100X225VA1Y	White print-on area, vinyl label for 8 – 4 AWG wires.	1.00	25.40	2.25	57.15	.75	19.05	.24	6.06	.48	12.13	1500	18000
S100X225VATY	White print-on area, vinyl label for 8 – 4 AWG wires.	1.00	25.40	2.25	57.15	.75	19.05	.24	6.06	.48	12.13	5000	20000
S100X225VBTY	Blue print-on area, vinyl label for 8 – 4 AWG wires.	1.00	25.40	2.25	57.15	.75	19.05	.24	6.06	.48	12.13	5000	20000
S100X225VCTY	Brown print-on area, vinyl label for 8 – 4 AWG wires.	1.00	25.40	2.25	57.15	.75	19.05	.24	6.06	.48	12.13	5000	20000

*TEDLAR is a registered trademark of E.I. du Pont de Nemours and Company.
 Order number of labels required in multiples of Std. Pkg. Qty.
 Use with PANDUIT thermal transfer hybrid or wax ribbons.
 Labels are roll mounted on 3.00" cores; when using the TDP43MY printer and 3.00" cores, the roll stand (TDP43M-RS) is required.

Table continues on page E2.8

A.
System
Overview

B1.
Cable Ties

B2.
Cable
Accessories

B3.
Stainless
Steel Ties

C1.
Wiring
Duct

C2.
Surface
Raceway

C3.
Abrasion
Protection

C4.
Cable
Management

D1.
Terminals

D2.
Power
Connectors

D3.
Grounding
Connectors

E1.
Labeling
Systems

E2.
Labels

E3.
Pre-Printed
& Write-On
Markers

E4.
Permanent
Identification

E5.
Lockout/
Tagout
& Safety
Solutions

F.
Index

A.
System
Overview

Thermal Transfer Self-Laminating Labels (continued)

B1.
Cable Ties

B2.
Cable
Accessories

B3.
Stainless
Steel Ties

C1.
Wiring
Duct

C2.
Surface
Raceway

C3.
Abrasion
Protection

C4.
Cable
Management

D1.
Terminals

D2.
Power
Connectors

D3.
Grounding
Connectors

E1.
Labeling
Systems

E2.
Labels

E3.
Pre-Printed
& Write-On
Markers

E4.
Permanent
Identification

E5.
Lockout/
Tagout/
& Safety
Solutions

F.
Index

Part Number	Part Description	Width		Length		Print-On Area Height		Min. Cable O.D.		Max. Wire O.D.		Std. Pkg. Qty.	Std. Ctn. Qty.
		In.	mm	In.	mm	In.	mm	In.	mm	In.	mm		
S100X225VDTY	Green print-on area, vinyl label for 8 – 4 AWG wires.	1.00	25.40	2.25	57.15	.75	19.05	.24	6.06	.48	12.13	5000	20000
S100X225VETY	Gray print-on area, vinyl label for 8 – 4 AWG wires.	1.00	25.40	2.25	57.15	.75	19.05	.24	6.06	.48	12.13	5000	20000
S100X225VFTY	Orange print-on area, vinyl label for 8 – 4 AWG wires.	1.00	25.40	2.25	57.15	.75	19.05	.24	6.06	.48	12.13	5000	20000
S100X225VGTY	Purple print-on area, vinyl label for 8 – 4 AWG wires.	1.00	25.40	2.25	57.15	.75	19.05	.24	6.06	.48	12.13	5000	20000
S100X225VHTY	Red print-on area, vinyl label for 8 – 4 AWG wires.	1.00	25.40	2.25	57.15	.75	19.05	.24	6.06	.48	12.13	5000	20000
S100X225VITY	Yellow print-on area, vinyl label for 8 – 4 AWG wires.	1.00	25.40	2.25	57.15	.75	19.05	.24	6.06	.48	12.13	5000	20000
S100X225V0TY	Black print-on area, vinyl label for 8 – 4 AWG wires.	1.00	25.40	2.25	57.15	.75	19.05	.24	6.06	.48	12.13	5000	20000
S100X225V9TY	Gold print-on area, vinyl label for 8 – 4 AWG wires.	1.00	25.40	2.25	57.15	.75	19.05	.24	6.06	.48	12.13	5000	20000
S100X400VA1Y	White print-on area, vinyl label for 2 – 1 AWG wires.	1.00	25.40	4.00	101.60	1.00	25.40	.32	8.09	.95	24.26	1000	4000
S100X400VATY	White print-on area, vinyl label for 2 – 1 AWG wires.	1.00	25.40	4.00	101.60	1.00	25.40	.32	8.09	.95	24.26	2500	12500
S100X650VA1Y	White print-on area, vinyl label for 1/0 – 250 MCM wires.	1.00	25.40	6.50	165.10	1.50	38.10	.48	12.13	1.59	40.43	250	1000
S100X650VATY	White print-on area, vinyl label for 1/0 – 250 MCM wires.	1.00	25.40	6.50	165.10	1.50	38.10	.48	12.13	1.59	40.43	1000	2000
S150X150VATY	White print-on area, vinyl label for Cat 5e/Cat 6 cables.	1.50	38.10	1.50	38.10	.50	12.70	.16	4.04	.32	8.09	5000	20000
S150X225VATY	White print-on area, vinyl label for 8 – 4 AWG wires.	1.50	38.10	2.25	57.15	.75	19.05	.24	6.06	.48	12.13	5000	20000
S150X400VATY	White print-on area, vinyl label for 2 – 1 AWG wires.	1.50	38.10	4.00	101.60	1.00	25.40	.32	8.09	.95	24.26	2500	10000
S200X225VA1Y	White print-on area, vinyl label for 8 – 4 AWG wires.	2.00	50.80	2.25	57.15	.75	19.05	.24	6.06	.48	12.13	500	2000
S200X225VATY	White print-on area, vinyl label for 8 – 4 AWG wires.	2.00	50.80	2.25	57.15	.75	19.05	.24	6.06	.48	12.13	1000	4000
S200X400TAT	White print-on area, TEDLAR® label for 2 – 1 AWG wires.	2.00	50.80	4.00	101.60	1.00	25.40	.32	8.09	.95	24.26	500	2000
S200X400VA1Y	White print-on area, vinyl label for 2 – 1 AWG wires.	2.00	50.80	4.00	101.60	1.00	25.40	.32	8.09	.95	24.26	500	2000
S200X400VATY	White print-on area, vinyl label for 2 – 1 AWG wires.	2.00	50.80	4.00	101.60	1.00	25.40	.32	8.09	.95	24.26	1000	3000
S200X650VA1Y	White print-on area, vinyl label for 1/0 – 250 MCM wires.	2.00	50.80	6.50	165.10	1.50	38.10	.48	12.13	1.59	40.43	250	1000
S200X650VATY	White print-on area, vinyl label for 1/0 – 250 MCM wires.	2.00	50.80	6.50	165.10	1.50	38.10	.48	12.13	1.59	40.43	1000	2000

*TEDLAR is a registered trademark of E.I. du Pont de Nemours and Company.
 Order number of labels required in multiples of Std. Pkg. Qty.
 Use with *PANDUIT* thermal transfer hybrid or wax ribbons.
 Labels are roll mounted on 3.00" cores; when using the TDP43MY printer and 3.00" cores, the roll stand (TDP43M-RS) is required.

Thermal Transfer Marker Plates



- Non-adhesive marker plates offer crisp, clear legends with superior legibility
- Attachable in a horizontal or vertical orientation
- Available in a variety of colors and sizes
- Use with *PANDUIT* RMR4BL resin thermal transfer ribbon

Part Number	Part Description	Width		Height		Print-On Area Width		Std. Pkg. Qty.	Std. Ctn. Qty.
		In.	mm	In.	mm	In.	mm		
M300X100Y6T	Yellow, thermal transfer marker plate.	3.00	76.20	1.00	25.40	1.80	45.70	1	4
M300X100Y7T	White, thermal transfer marker plate.	3.00	76.20	1.00	25.40	1.80	45.70	1	4
M300X050Y6T	Yellow, thermal transfer marker plate.	3.00	76.20	.50	12.70	1.80	45.70	1	4
M300X050Y7T	White, thermal transfer marker plate.	3.00	76.20	.50	12.70	1.80	45.70	1	4
M200X100Y6T	Yellow, thermal transfer marker plate.	2.00	50.80	1.00	25.40	.80	20.30	1	4
M200X100Y7T	White, thermal transfer marker plate.	2.00	50.80	1.00	25.40	.80	20.30	1	4
M200X050Y6T	Yellow, thermal transfer marker plate.	2.00	50.80	.50	12.70	1.07	27.30	1	4
M200X050Y7T	White, thermal transfer marker plate.	2.00	50.80	.50	12.70	1.07	27.30	1	4

Order number of marker plates required in multiples of Std. Pkg. Qty.

A.
System
Overview

B1.
Cable
Ties

B2.
Cable
Accessories

B3.
Stainless
Steel Ties

C1.
Wiring
Duct

C2.
Surface
Raceway

C3.
Abrasion
Protection

C4.
Cable
Management

D1.
Terminals

D2.
Power
Connectors

D3.
Grounding
Connectors

E1.
Labeling
Systems

E2.
Labels

E3.
Pre-Printed
& Write-On
Markers

E4.
Permanent
Identification

E5.
Lockout/
Tagout/
& Safety
Solutions

F.
Index

A. System Overview

Thermal Transfer Non-Laminated Labels

- Labels offer crisp, clear legends with superior legibility
- Use as a wrap-around label or flag style marker for wire/cable labeling
- Available in vinyl cloth material for long-term or temporary labeling and supplied on rolls
- *PANDUIT* labeling software packages include all label formats for quick and easy label production

B1. Cable Ties

B2. Cable Accessories



B3. Stainless Steel Ties

C1. Wiring Duct

Part Number System for Non-Laminated Labels

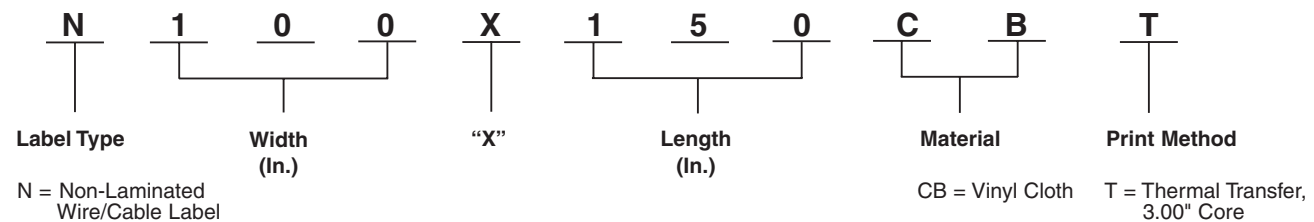

C2. Surface Raceway

C3. Abrasion Protection

C4. Cable Management

Material/Print Method Selection Guide

Material	Print Method	Temperature Range	Features
Vinyl Cloth, White (CB)	Thermal Transfer (T)	-50°F to 170°F (-46°C to 77°C)	Indoor/outdoor rated; thin conformable material with repositionable adhesive allows label to be removed and reused or used in temporary applications; provides durability, high temperature resistance, and dimensional stability for rough or textured surfaces; resists oil and abrasion.

D1. Terminals

D2. Power Connectors

D3. Grounding Connectors

Part Number	Part Description	Width		Length		Min. Cable O.D.		Max. Cable O.D.		Std. Pkg. Qty.	Std. Ctn. Qty.
		In.	mm	In.	mm	In.	mm	In.	mm		
N025X075CBT	White, vinyl cloth label.	.25	6.35	.75	19.05	.24	6.10	.51	12.95	10000	40000
N025X125CBT	White, vinyl cloth label.	.25	6.35	1.25	31.75	.40	10.16	.85	21.59	10000	40000
N025X150CBT	White, vinyl cloth label.	.25	6.35	1.50	38.10	.48	12.19	1.02	25.91	2500	10000
N025X175CBT	White, vinyl cloth label.	.25	6.35	1.75	44.45	.56	14.22	1.19	30.23	10000	40000
N050X075CBT	White, vinyl cloth label.	.50	12.70	.75	19.05	.24	6.10	.51	12.95	10000	40000
N050X100CBT	White, vinyl cloth label.	.50	12.70	1.00	25.40	.32	8.13	.68	17.27	10000	40000
N050X125CBT	White, vinyl cloth label.	.50	12.70	1.25	31.75	.40	10.16	.85	21.59	10000	40000
N050X150CBT	White, vinyl cloth label.	.50	12.70	1.50	38.10	.48	12.19	1.02	25.91	2500	10000
N050X175CBT	White, vinyl cloth label.	.50	12.70	1.75	44.45	.56	14.12	1.19	30.23	2500	10000
N100X075CBT	White, vinyl cloth label.	1.00	25.40	.75	19.05	.24	6.10	.51	12.95	10000	40000
N100X125CBT	White, vinyl cloth label.	1.00	25.40	1.25	31.75	.40	10.16	.85	21.59	5000	20000
N100X150CBT	White, vinyl cloth label.	1.00	25.40	1.50	38.10	.48	12.19	1.02	25.91	5000	20000
N100X175CBT	White, vinyl cloth label.	1.00	25.40	1.75	44.45	.56	14.22	1.19	30.23	2500	10000

E1. Labeling Systems

E2. Labels

E3. Pre-Printed & Write-On Markers

E4. Permanent Identification

E5. Lockout/Tagout & Safety Solutions

F. Index

Order number of labels required in multiples of Std. Pkg. Qty.
 Use with *PANDUIT* thermal transfer hybrid or wax ribbons found on page E1.14.
 *Labels are roll mounted on 3.00" cores; when using the TDP43M printer and 3.00" cores, the roll stand (TDP43M-RS) is required.

Thermal Transfer Commercial Grade Heat Shrink Labels

- Labels offer crisp, clear legends with superior legibility
- Meets UL Standard 224 for flammability and UL Standard 2043 suitable for use in air handling spaces
- Shrink ratio 3:1
- Pre-cut flattened polyolefin is both thermal transfer and dot matrix printable and supplied roll mounted on plastic carrier
- **PANDUIT** labeling software packages include all label formats for quick and easy label production



Part Number System for Heat Shrink Labels

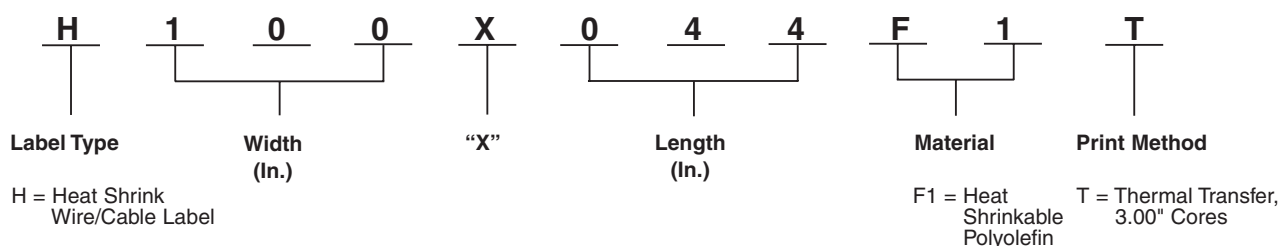

Material/Print Method Selection Guide

Material	Print Method	Temperature Range	Features
Heat Shrinkable Polyolefin, White (F1) Yellow (F2)	Thermal Transfer (T)	-22°F to 220°F (-30°C to 105°C)	Durable flattened polyolefin, high quality heat shrink wire/cable labels.

Part Number	Part Description	Width		Length		Min. Cable O.D.		Max. Cable O.D.		Std. Pkg. Qty.
		In.	mm	In.	mm	In.	mm	In.	mm	
H050X025F1T	White, 1/8" diameter polyolefin, 2000/roll.	.50	12.70	.25	6.35	.04	1.02	.13	3.30	1
H050X025F1T-B	White, 1/8" diameter polyolefin, 10000/roll.	.50	12.70	.25	6.35	.04	1.02	.13	3.30	1
H050X025F2T	Yellow, 1/8" diameter polyolefin, 2000/roll.	.50	12.70	.25	6.35	.04	1.02	.13	3.30	1
H050X034F1T	White, 3/16" diameter polyolefin, 2000/roll.	.50	12.70	.34	8.64	.06	1.52	.19	4.83	1
H050X034F1T-B	White, 3/16" diameter polyolefin, 10000/roll.	.50	12.70	.34	8.64	.06	1.52	.19	4.83	1
H050X034F2T	Yellow, 3/16" diameter polyolefin, 2000/roll.	.50	12.70	.34	8.64	.06	1.52	.19	4.83	1
H050X044F1T	White, 1/4" diameter polyolefin, 2000/roll.	.50	12.70	.44	11.18	.08	2.03	.25	6.35	1
H050X044F1T-B	White, 1/4" diameter polyolefin, 10000/roll.	.50	12.70	.44	11.18	.08	2.03	.25	6.35	1
H050X044F2T	Yellow, 1/4" diameter polyolefin, 2000/roll.	.50	12.70	.44	11.18	.08	2.03	.25	6.35	1
H050X064F1T	White, 3/8" diameter polyolefin, 2000/roll.	.50	12.70	.64	16.26	.13	3.30	.38	9.65	1
H050X064F1T-B	White, 3/8" diameter polyolefin, 10000/roll.	.50	12.70	.64	16.26	.13	3.30	.38	9.65	1
H075X025F1T	White, 1/8" diameter polyolefin, 1000/roll.	.75	19.05	.25	6.35	.04	1.02	.13	3.30	1
H075X034F1T	White, 3/16" diameter polyolefin, 1000/roll.	.75	19.05	.34	8.64	.06	1.52	.19	4.57	1
H075X044F1T	White, 1/4" diameter polyolefin, 1000/roll.	.75	19.05	.44	11.18	.08	2.03	.25	6.35	1
H100X025F1T	White, 1/8" diameter polyolefin, 1000/roll.	1.00	25.40	.25	6.35	.04	1.02	.13	3.30	1
H100X025F1T-B	White, 1/8" diameter polyolefin, 5000/roll.	1.00	25.40	.25	6.35	.04	1.02	.13	3.30	1
H100X025F2T	Yellow, 1/8" diameter polyolefin, 1000/roll.	1.00	25.40	.25	6.35	.04	1.02	.13	3.30	1

Order number of rolls required.

Table continues on page E2.12.

A.
System
Overview

Thermal Transfer Commercial Grade Heat Shrink Labels (continued)

B1.
Cable Ties

B2.
Cable
Accessories

B3.
Stainless
Steel Ties

C1.
Wiring
Duct

C2.
Surface
Raceway

C3.
Abrasion
Protection

C4.
Cable
Management

D1.
Terminals

D2.
Power
Connectors

D3.
Grounding
Connectors

E1.
Labeling
Systems

E2.
Labels

E3.
Pre-Printed
& Write-On
Markers

E4.
Permanent
Identification

E5.
Lockout/
Tagout
& Safety
Solutions

F.
Index

Part Number	Part Description	Width		Length		Min. Cable O.D.		Max. Cable O.D.		Std. Pkg. Qty.
		In.	mm	In.	mm	In.	mm	In.	mm	
H100X034F1T	White, 3/16" diameter polyolefin, 1000/roll.	1.00	25.40	.34	8.64	.06	1.52	.19	4.83	1
H100X034F1T-B	White, 3/16" diameter polyolefin, 5000/roll.	1.00	25.40	.34	8.64	.06	1.52	.19	4.83	1
H100X034F2T	Yellow, 3/16" diameter polyolefin, 1000/roll.	1.00	25.40	.34	8.64	.06	1.52	.19	4.83	1
H100X044F1T	White, 1/4" diameter polyolefin, 1000/roll.	1.00	25.40	.44	11.18	.08	2.03	.25	6.35	1
H100X044F1T-B	White, 1/4" diameter polyolefin, 5000/roll.	1.00	25.40	.44	11.18	.08	2.03	.25	6.35	1
H100X044F2T	Yellow, 1/4" diameter polyolefin, 1000/roll.	1.00	25.40	.44	11.18	.08	2.03	.25	6.35	1
H100X064F1T	White, 3/8" diameter polyolefin, 1000/roll.	1.00	25.40	.64	16.26	.13	3.30	.38	9.65	1
H100X064F1T-B	White, 3/8" diameter polyolefin, 5000/roll.	1.00	25.40	.64	16.26	.13	3.30	.38	9.65	1
H100X084F1T	White, 1/2" diameter polyolefin, 1000/roll.	1.00	25.40	.84	21.34	.17	4.32	.50	12.70	1
H100X084F2T	Yellow, 1/2" diameter polyolefin, 1000/roll.	1.00	25.40	.84	21.34	.17	4.32	.50	12.70	1
H100X165F1T	White, 1" diameter polyolefin, 500/roll.	1.00	25.40	1.65	41.91	.33	8.38	1.00	25.40	1
H100X165F2T	Yellow, 1" diameter polyolefin, 500/roll.	1.00	25.40	1.65	41.91	.33	8.38	1.00	25.40	1
H150X025F1T	White, 1/8" diameter polyolefin, 500/roll.	1.50	38.10	.25	6.35	.04	1.02	.13	3.30	1
H150X034F1T	White, 3/16" diameter polyolefin, 500/roll.	1.50	38.10	.34	8.64	.06	1.52	.19	4.83	1
H150X044F1T	White, 1/4" diameter polyolefin, 500/roll.	1.50	38.10	.44	11.18	.08	2.03	.25	6.35	1
H200X025F1T	White, 1/8" diameter polyolefin, 500/roll.	2.00	50.80	.25	6.35	.04	1.02	.13	3.30	1
H200X025F1T-B	White, 1/8" diameter polyolefin, 2500/roll.	2.00	50.80	.25	6.35	.04	1.02	.13	3.20	1
H200X025F2T	Yellow, 1/8" diameter polyolefin, 500/roll.	2.00	50.80	.25	6.35	.04	1.02	.13	3.20	1
H200X034F1T	White, 3/16" diameter polyolefin, 500/roll.	2.00	50.80	.34	8.64	.06	1.52	.19	4.83	1
H200X034F1T-B	White, 3/16" diameter polyolefin, 2500/roll.	2.00	50.80	.34	8.64	.06	1.52	.19	4.80	1
H200X034F2T	Yellow, 3/16" diameter polyolefin, 500/roll.	2.00	50.80	.34	8.61	.06	1.52	.19	4.80	1
H200X044F1T	White, 1/4" diameter polyolefin, 500/roll.	2.00	50.80	.44	11.18	.08	2.03	.25	6.35	1
H200X044F1T-B	White, 1/4" diameter polyolefin, 2500/roll.	2.00	50.80	.44	11.18	.08	2.03	.25	6.35	1
H200X044F2T	Yellow, 1/4" diameter polyolefin, 500/roll.	2.00	50.80	.44	11.18	.08	2.03	.25	6.35	1
H200X064F1T	White, 3/8" diameter polyolefin, 500/roll.	2.00	50.80	.64	16.26	.13	3.30	.38	9.65	1
H200X064F1T-B	White, 3/8" diameter polyolefin, 2500/roll.	2.00	50.80	.64	16.26	.13	3.30	.38	9.65	1
H200X084F1T	White, 1/2" diameter polyolefin, 500/roll.	2.00	50.80	.84	21.34	.17	4.32	.50	12.70	1
H200X084F2T	Yellow, 1/2" diameter polyolefin, 500/roll.	2.00	50.80	.84	21.34	.17	4.32	.50	12.70	1
H200X165F1T	White, 1" diameter polyolefin, 250/roll.	2.00	50.80	1.65	41.91	.33	8.38	1.00	25.40	1
H200X165F2T	Yellow, 1" diameter polyolefin, 250/roll.	2.00	50.80	1.65	41.91	.33	8.38	1.00	25.40	1

Order number of rolls required.

Thermal Transfer Military Grade Heat Shrink Labels

- Labels offer crisp, clear legends with superior legibility
- Meets UL Standard 224 for flammability and AMS-DTL-23053/5C (Class 1 and Class 3)
- Will meet MIL-M-81531, MIL-STD202F, and MIL-STD-883E when printed with RMH4BL or RHH4BL-S ribbons
- Shrink ratio 3:1
- Pre-cut flattened polyolefin is both thermal transfer and dot matrix printable and supplied roll mounted on plastic carrier
- PANDUIT labeling software packages include all label formats for quick and easy label production



Part Number System for Heat Shrink Labels

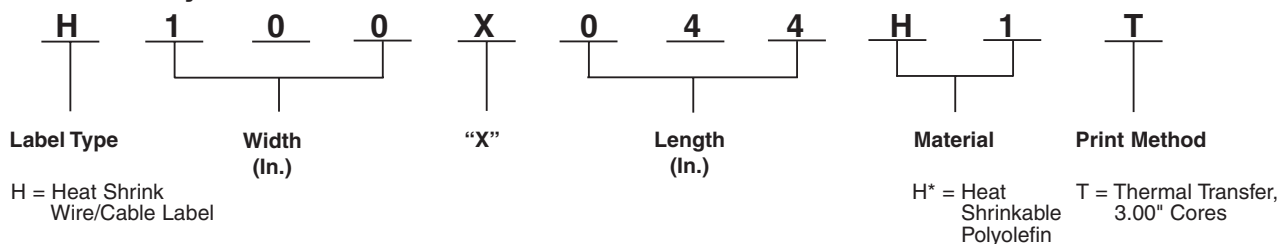

Material/Print Method Selection Guide

Material	Print Method	Temperature Range	Features
Heat Shrinkable Polyolefin, White (H1) Yellow (H2)	Thermal Transfer (T)	-67°F to 275°F (-55°C to 135°C)	Durable flattened polyolefin, high quality heat shrink wire/cable labels.

Part Number	Part Description	Width		Length		Min. Cable		Max. Cable O.D.		Std. Pkg. Qty.
		In.	mm	In.	mm	In.	mm	In.	mm	
H050X025H1T	White, 1/8" diameter polyolefin, 2000/roll.	.50	12.70	.25	6.35	.04	1.02	.13	3.30	1
H050X025H1T-B	White, 1/8" diameter polyolefin, 10000/roll.	.50	12.70	.25	6.35	.04	1.02	.13	3.30	1
H050X025H2T	Yellow, 1/8" diameter polyolefin, 2000/roll.	.50	12.70	.25	6.35	.04	1.02	.13	3.30	1
H050X034H1T	White, 3/16" diameter polyolefin, 2000/roll.	.50	12.70	.34	8.64	.06	1.52	.19	4.83	1
H050X034H1T-B	White, 3/16" diameter polyolefin, 10000/roll.	.50	12.70	.34	8.64	.06	1.52	.19	4.83	1
H050X034H2T	Yellow, 3/16" diameter polyolefin, 2000/roll.	.50	12.70	.34	8.64	.06	1.52	.19	4.83	1
H050X044H1T	White, 1/4" diameter polyolefin, 2000/roll.	.50	12.70	.44	11.18	.08	2.03	.25	6.35	1
H050X044H1T-B	White, 1/4" diameter polyolefin, 10000/roll.	.50	12.70	.44	11.18	.08	2.03	.25	6.35	1
H050X044H2T	Yellow, 1/4" diameter polyolefin, 2000/roll.	.50	12.70	.44	11.18	.08	2.03	.25	6.35	1
H050X064H1T	White, 3/8" diameter polyolefin, 2000/roll.	.50	12.70	.64	16.26	.13	3.30	.38	9.65	1
H050X064H1T-B	White, 3/8" diameter polyolefin, 10000/roll.	.50	12.70	.64	16.26	.13	3.30	.38	9.65	1
H075X025H1T	White, 1/8" diameter polyolefin, 1000/roll.	.75	19.05	.25	6.35	.04	1.02	.13	3.30	1
H075X034H1T	White, 1/8" diameter polyolefin, 1000/roll.	.75	19.05	.25	6.35	.04	1.02	.13	3.30	1
H075X044H1T	White, 1/8" diameter polyolefin, 5000/roll.	.75	19.05	.25	6.35	.04	1.02	.13	3.30	1
H100X025H1T	White, 1/8" diameter polyolefin, 1000/roll.	1.00	25.40	.25	6.35	.04	1.02	.13	3.30	1
H100X025H1T-B	White, 1/8" diameter polyolefin, 5000/roll.	1.00	25.40	.25	6.35	.04	1.02	.13	3.30	1
H100X025H2T	Yellow, 1/8" diameter polyolefin, 1000/roll.	1.00	25.40	.25	6.35	.04	1.02	.13	3.30	1
H100X034H1T	White, 3/16" diameter polyolefin, 1000/roll.	1.00	25.40	.34	8.64	.06	1.52	.19	4.83	1
H100X034H1T-B	White, 3/16" diameter polyolefin, 5000/roll.	1.00	25.40	.34	8.64	.06	1.52	.19	4.83	1
H100X034H2T	Yellow, 3/16" diameter polyolefin, 1000/roll.	1.00	25.40	.34	8.64	.06	1.52	.19	4.83	1

Table continues on page E2.14

A. System Overview

B1. Cable Ties

B2. Cable Accessories

B3. Stainless Steel Ties

C1. Wiring Duct

C2. Surface Raceway

C3. Abrasion Protection

C4. Cable Management

D1. Terminals

D2. Power Connectors

D3. Grounding Connectors

E1. Labeling Systems

E2. Labels

E3. Pre-Printed & Write-On Markers

E4. Permanent Identification

E5. Lockout/Tagout & Safety Solutions

F. Index

A.
System
Overview

Thermal Transfer Military Grade Heat Shrink Labels (continued)

B1.
Cable Ties

B2.
Cable
Accessories

B3.
Stainless
Steel Ties

C1.
Wiring
Duct

C2.
Surface
Raceway

C3.
Abrasion
Protection

C4.
Cable
Management

D1.
Terminals

D2.
Power
Connectors

D3.
Grounding
Connectors

E1.
Labeling
Systems

E2.
Labels

E3.
Pre-Printed
& Write-On
Markers

E4.
Permanent
Identification

E5.
Lockout/
Tagout
& Safety
Solutions

F.
Index

Part Number	Part Description	Width		Length		Min. Cable		Max. Cable O.D.		Std. Pkg. Qty.
		In.	mm	In.	mm	In.	mm	In.	mm	
H100X044H1T	White, 1/4" diameter polyolefin, 1000/roll.	1.00	25.40	.44	11.18	.08	2.03	.25	6.35	1
H100X044H1T-B	White, 1/4" diameter polyolefin, 5000/roll.	1.00	25.40	.44	11.18	.08	2.03	.25	6.35	1
H100X044H2T	Yellow, 1/4" diameter polyolefin, 1000/roll.	1.00	25.40	.44	11.18	.08	2.03	.25	6.35	1
H100X064H1T	White, 3/8" diameter polyolefin, 1000/roll.	1.00	25.40	.64	16.26	.13	3.30	.38	9.65	1
H100X064H1T-B	White, 3/8" diameter polyolefin, 5000/roll.	1.00	25.40	.64	16.26	.13	3.30	.38	9.65	1
H100X084H1T	White, 1/2" diameter polyolefin, 1000/roll.	1.00	25.40	.84	21.34	.17	4.32	.50	12.70	1
H100X084H2T	Yellow, 1/2" diameter polyolefin, 1000/roll.	1.00	25.40	.84	21.34	.17	4.32	.50	12.70	1
H100X165H1T	White, 1" diameter polyolefin, 500/roll.	1.00	25.40	1.65	41.91	.33	8.38	1.00	25.40	1
H100X165H2T	Yellow, 1" diameter polyolefin, 500/roll.	1.00	25.40	1.65	41.91	.33	8.38	1.00	25.40	1
H150X025H1T	White, 1/8" diameter polyolefin, 500/roll.	1.50	38.10	.25	6.35	.04	1.02	.13	3.30	1
H150X034H1T	White, 3/16" diameter polyolefin, 500/roll.	1.50	38.10	.34	8.64	.06	1.52	.19	4.83	1
H150X044H1T	White, 1/4" diameter polyolefin, 500/roll.	1.50	38.10	.44	11.18	.08	2.03	.25	6.35	1
H200X025H1T	White, 1/8" diameter polyolefin, 500/roll.	2.00	50.80	.25	6.35	.04	1.02	.13	3.20	1
H200X025H1T-B	White, 1/8" diameter polyolefin, 2500/roll.	2.00	50.80	.25	6.35	.04	1.02	.13	3.20	1
H200X025H2T	Yellow, 1/8" diameter polyolefin, 500/roll.	2.00	50.80	.25	6.35	.04	1.02	.13	3.20	1
H200X034H1T	White, 3/16" diameter polyolefin, 500/roll.	2.00	50.80	.34	8.61	.06	1.52	.19	4.80	1
H200X034H1T-B	White, 3/16" diameter polyolefin, 2500/roll.	2.00	50.80	.34	8.61	.06	1.52	.19	4.83	1
H200X034H2T	Yellow, 3/16" diameter polyolefin, 500/roll.	2.00	50.80	.34	8.61	.06	1.52	.19	4.83	1
H200X044H1T	White, 1/4" diameter polyolefin, 500/roll.	2.00	50.80	.44	11.18	.08	2.03	.25	6.35	1
H200X044H1T-B	White, 1/4" diameter polyolefin, 2500/roll.	2.00	50.80	.44	11.18	.08	2.03	.25	6.35	1
H200X044H2T	Yellow, 1/4" diameter polyolefin, 500/roll.	2.00	50.80	.44	11.18	.08	2.03	.25	6.35	1
H200X064H1T	White, 3/8" diameter polyolefin, 500/roll.	2.00	50.80	.64	16.26	.13	3.30	.38	9.65	1
H200X064H1T-B	White, 3/8" diameter polyolefin, 2500/roll.	2.00	50.80	.64	16.26	.13	3.30	.38	9.65	1
H200X084H1T	White, 1/2" diameter polyolefin, 500/roll.	2.00	50.80	.84	21.34	.17	4.32	.50	12.70	1
H200X084H2T	Yellow, 1/2" diameter polyolefin, 500/roll.	2.00	50.80	.84	21.34	.17	4.32	.50	12.70	1
H200X165H1T	White, 1" diameter polyolefin, 250/roll.	2.00	50.80	1.65	41.91	.33	8.38	1.00	25.40	1
H200X165H2T	Yellow, 1" diameter polyolefin, 250/roll.	2.00	50.80	1.65	41.91	.33	8.38	1.00	25.40	1

Order number of rolls required.

UL LISTED SP Heat Shrink Tools and Accessories

- Adjustable air intake regulator provides variable temperature adjustment within the units rated heat range
- Toggle type control switch provides hot/cold/off operation
- Replaceable brushes are easy to service and extend the operating life of the gun
- Unique suspended quick change heating element design prolongs life and eases servicing



Part Number	Part Description	Std. Pkg. Qty.	Std. Ctn. Qty.
HSG-115V-650	Heat gun with temperature range of 650°F (344°C) to 900°F (482°C).	1	—
HSG-A1	Shrink tube reflector for tubing up to 3/4" inside diameter. Directs heat around tubing to reduce shrink time.	1	10
HSG-A2	Shrink tube reflector for tubing up to 1 1/2" inside diameter. Directs heat around tubing to reduce shrink time.	1	10
HSG-A3	Shrink tube concentrator. Directs heat toward tubing and away from heat sensitive items.	1	10
HSG-A4	Black polyethylene case stores heat gun, stand, and all three accessories.	1	—
HSG-P1	Replacement brush/spring kit.	1	5
HSG-P2	Replacement switch 20 Amps.	1	5
HSG-P3	Replacement bearing kit.	1	5
HSG-P7	Replacement heat element 650°F.	1	—

Thermal Transfer Component Labels

- Labels offer crisp, clear legends with superior legibility
- Available in polyester, vinyl cloth, and polyimide materials and supplied on rolls

- Designed for use with thermal transfer desktop printers, including the TDP43MY and TDP42HY printers
- PANDUIT labeling software packages include all label formats for quick and easy label production



Part Number System for Component Labels

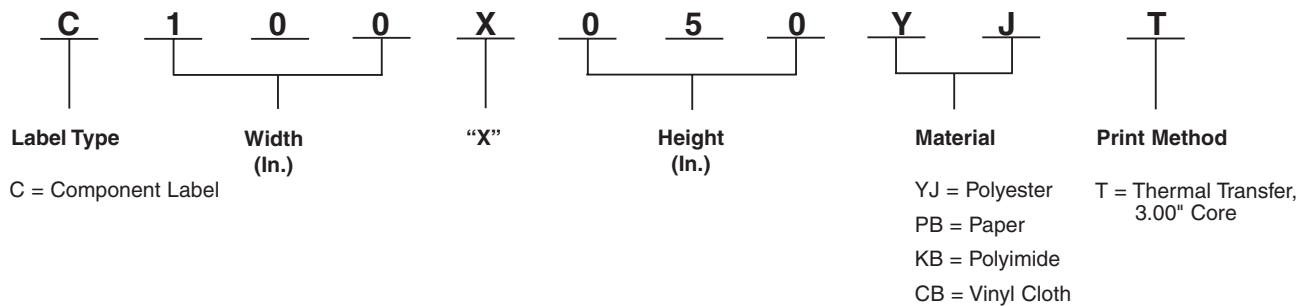

Material/Print Method Selection Guide

Material	Print Method	Temperature Range	Features
Polyester, White (YJ)	Thermal Transfer (T)	-40°F to 302°F (-40°C to 150°C)	Indoor/outdoor rated; provides durability, high temperature resistance and dimensional stability; does not stretch or easily tear.
Paper, White (PB)		-65°F to 200°F (-54°C to 93°C)	Indoor rated; general purpose material; excellent adhesion properties when applied to a clean dry surface.
Polyimide, White (KB)		-40°F to 350°F (-40°C to 177°C)	Indoor rated; ideal for electronic components and internal circuitry applications; material is intended for applications requiring solvent and high temperature resistance performance, such as the wave solder process.
Vinyl Cloth, White (CB)		-50°F to 170°F (-46°C to 77°C)	Indoor/outdoor rated; thin conformable material with repositionable adhesive allows label to be removed and reused or used in temporary applications; provides durability, high temperature resistance, and dimensional stability for rough or textured surfaces; resists oil and abrasion.

A.
System
Overview

B1.
Cable Ties

B2.
Cable
Accessories

B3.
Stainless
Steel Ties

C1.
Wiring
Duct

C2.
Surface
Raceway

C3.
Abrasion
Protection

C4.
Cable
Management

D1.
Terminals

D2.
Power
Connectors

D3.
Grounding
Connectors

E1.
Labeling
Systems

E2.
Labels

E3.
Pre-Printed
& Write-On
Markers

E4.
Permanent
Identification

E5.
Lockout/
Tagout/
& Safety
Solutions

F.
Index

A.
System
Overview

Thermal Transfer Component Labels (continued)

B1.
Cable Ties

B2.
Cable
Accessories

B3.
Stainless
Steel Ties

C1.
Wiring
Duct

C2.
Surface
Raceway

C3.
Abrasion
Protection

C4.
Cable
Management

D1.
Terminals

D2.
Power
Connectors

D3.
Grounding
Connectors

E1.
Labeling
Systems

E2.
Labels

E3.
Pre-Printed
& Write-On
Markers

E4.
Permanent
Identification

E5.
Lockout/
Tagout
& Safety
Solutions

F.
Index

Part Number	Part Description	Width		Height		Std. Pkg. Qty.	Std. Ctn. Qty.
		In.	mm	In.	mm		
C025X025KBT	White, polyimide label.	.25	6.35	.25	6.35	10000	40000
C025X025KCT	Tan, polyimide label.	0.25	6.35	.25	6.35	10000	40000
C025X025YJT	White, polyester label.	.25	6.35	.25	6.35	10000	40000
C038X038KBT	White, polyimide label.	.38	9.65	.38	9.65	10000	40000
C038X038KCT	Tan, polyimide label.	0.38	9.65	.38	9.65	10000	40000
C038X038YJT	White, polyester label.	.38	9.65	.38	9.65	10000	40000
C050X013KBT	White, polyimide label..	0.50	12.70	.13	3.30	10000	40000
C050X013KCT	Tan, polyimide label.	0.50	12.70	.13	3.30	10000	40000
C050X044KCT	Tan, polyimide label.	0.50	12.70	.44	11.18	10000	40000
C050X044CBT	White, vinyl cloth label.	.50	12.70	.44	11.18	10000	40000
C050X044KBT	White, polyimide label.	.50	12.70	.44	11.18	10000	40000
C050X044YJT	White, polyester label.	.50	12.70	.44	11.18	10000	40000
C060X020CBT	White, vinyl cloth label.	.60	15.24	.20	5.08	10000	40000
C060X020KBT	White, polyimide label.	.60	15.24	.20	5.08	10000	40000
C060X020KCT	Tan, polyimide label.	0.60	15.24	.20	5.08	10000	40000
C060X020TJT	White, TEDLAR® label.	.60	15.24	.20	5.08	10000	40000
C060X020YJT	White, polyester label.	.60	15.24	.20	5.08	10000	40000
C065X019KBT	White, polyimide label.	0.65	16.51	.19	4.83	10000	40000
C065X019KCT	Tan, polyimide label.	0.65	16.51	.19	4.83	10000	40000
C075X025CBT	White, vinyl cloth label.	.75	19.05	.25	6.35	10000	40000
C075X025KBT	White, polyimide label.	.75	19.05	.25	6.35	10000	40000
C075X025KCT	Tan, polyimide label.	0.75	19.05	.25	6.35	10000	40000
C075X025YJT	White, polyester label.	.75	19.05	.25	6.35	10000	40000
C080X020KBT	White, polyimide label.	.80	20.32	.20	5.08	10000	40000
C080X020KCT	Tan, polyimide label.	0.80	20.32	.20	5.08	10000	40000
C080X020YJT	White, polyester label.	.80	20.32	.20	5.08	10000	40000
C090X025KBT	White, polyimide label..	0.90	22.86	.25	6.35	10000	40000
C090X025KCT	Tan, polyimide label.	0.90	22.86	.25	6.35	10000	40000
C100X019KBT	White, polyimide label.	1.00	25.40	.19	4.83	10000	40000
C100X019KCT	Tan, polyimide label.	1.00	25.40	.19	4.83	10000	40000
C100X025CBT	White, vinyl cloth label.	1.00	25.40	.25	6.35	10000	40000
C100X025KBT	White, polyimide label.	1.00	25.40	.25	6.35	10000	40000
C100X025KCT	Tan, polyimide label.	1.00	25.40	.25	6.35	10000	40000
C100X025YJT	White, polyester label.	1.00	25.40	.25	6.35	10000	40000
C100X038KBT	White, polyimide label.	1.00	25.40	.38	9.65	10000	40000
C100X038KCT	Tan, polyimide label.	1.00	25.40	.38	9.65	10000	40000
C100X050CBT	White, vinyl cloth label.	1.00	25.40	.50	12.70	10000	40000
C100X050YJT	White, polyester label.	1.00	25.40	.50	12.70	10000	40000
C125X025KBT	White, polyimide label.	1.25	31.75	.25	6.35	10000	40000
C125X025KCT	Tan, polyimide label.	1.25	31.75	.25	6.35	10000	40000
C150X025KBT	White, polyimide label.	1.50	38.10	.25	6.35	5000	20000
C150X025KCT	Tan, polyimide label.	1.50	38.10	.25	6.35	5000	20000
C150X075YJT	White, polyester label.	1.50	38.10	.75	19.05	5000	20000

*TEDLAR is a registered trademark of E.I. du Pont de Nemours and Company.
Order number of labels required in multiples of Std. Pkg. Qty.
Use with PANDUIT thermal transfer ribbons.

Labels roll mounted on 3.00" cores; when using the TDP43MY printer and 3.00" cores, the roll stand (TDP43M-RS) is required.

Thermal Transfer Component Labels (continued)

Part Number	Part Description	Width		Height		Std. Pkg. Qty.	Std. Ctn. Qty.
		In.	mm	In.	mm		
C160X020CBT	White, vinyl cloth label.	1.60	40.64	.20	5.08	10000	40000
C160X020KBT	White, polyimide label.	1.60	40.64	.20	5.08	10000	40000
C160X020KCT	Tan, polyimide label.	1.60	40.64	.20	5.08	10000	40000
C160X020YJT	White, polyester label.	1.60	40.64	.20	5.08	10000	40000
C200X025KBT	White, polyimide label.	2.00	50.80	.25	6.35	5000	20000
C200X025KCT	Tan, polyimide label.	2.00	50.80	.25	6.35	5000	20000
C200X050CBT	White, vinyl cloth label.	2.00	50.80	.50	12.70	5000	20000
C200X050YJT	White, polyester label.	2.00	50.80	.50	12.70	5000	20000
C200X100YJT	White, polyester label.	2.00	50.80	1.00	25.40	2500	10000
C300X025KBT	White, polyimide label.	3.00	76.20	.25	6.35	5000	20000
C300X025KCT	Tan, polyimide label.	3.00	76.20	.25	6.35	5000	20000
C400X100CBT	White, vinyl cloth label.	4.00	101.60	1.00	25.40	2500	10000
C400X100YJT	White, polyester label.	4.00	101.60	1.00	25.40	2500	10000
C400X200YJT	White, polyester label.	4.00	101.60	2.00	50.80	1000	4000
C400X400YJT	White, polyester label.	4.00	101.60	4.00	101.60	1000	4000
C400X600PBT	White, paper label.	4.00	101.60	6.00	152.40	1000	4000
C400X600YJT	White, polyester label.	4.00	101.60	6.00	152.40	1000	4000

*TEDLAR is a registered trademark of E.I. du Pont de Nemours and Company.

Order number of labels required in multiples of Std. Pkg. Qty.

Use with *PANDUIT* thermal transfer ribbons.

Labels roll mounted on 3.00" cores; when using the TDP43MY printer and 3.00" cores, the roll stand (TDP43M-RS) is required.

A.
System
Overview

B1.
Cable Ties

B2.
Cable
Accessories

B3.
Stainless
Steel Ties

C1.
Wiring
Duct

C2.
Surface
Raceway

C3.
Abrasion
Protection

C4.
Cable
Management

D1.
Terminals

D2.
Power
Connectors

D3.
Grounding
Connectors

E1.
Labeling
Systems

E2.
Labels

E3.
Pre-Printed
& Write-On
Markers

E4.
Permanent
Identification

E5.
Lockout/
Tagout
& Safety
Solutions

F.
Index

A.
System
Overview

Thermal Transfer Continuous Tapes

B1.
Cable
Ties

- Tapes offer crisp, clear legends with superior legibility
- Available in continuous vinyl or polyester and supplied on rolls

- *PANDUIT* labeling software packages include all label formats for quick and easy label production

B2.
Cable
Accessories



B3.
Stainless
Steel Ties

C1.
Wiring
Duct

Part Number System for Continuous Tapes

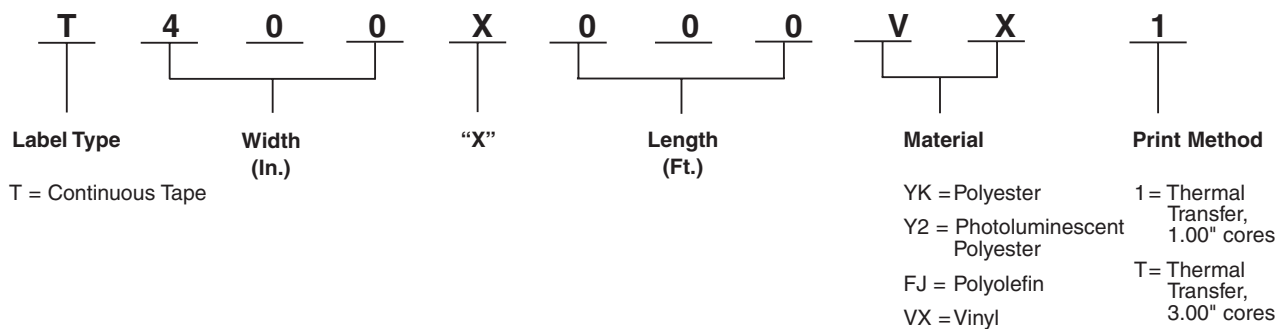

C2.
Surface
Raceway

C3.
Abrasion
Protection

C4.
Cable
Management

D1.
Terminals

Material/Print Method Selection Guide

Material	Print Method	Temperature Range	Features
Polyester, Clear (YK)	Thermal Transfer (T)	-40°F to 257°F (-40°C to 125°C)	Indoor/outdoor rated; provides durability, high temperature resistance, and dimensional stability; does not stretch or easily tear
Vinyl, Yellow (VX) Black (VY) Blue (VQ) Brown (VR) Gray (VT) Green (VS) Orange (VU) Purple (VV) Red (VW) White (VP)		-40°F to 200°F (40°C to 93°C)	Indoor/outdoor rated; conformable material for flat applications and safety and facility identification; can be overlaminated to increase durability

D2.
Power
Connectors

D3.
Grounding
Connectors

E1.
Labeling
Systems

E2.
Labels

E3.
Pre-Printed
& Write-On
Markers

E4.
Permanent
Identification

E5.
Lockout/
Tagout
& Safety
Solutions

F.
Index

Thermal Transfer Continuous Tapes (continued)

Part Number	Part Description	Height		Length		Std. Pkg. Qty.	Std. Ctn. Qty.
		In.	mm	Ft.	m		
T100X000VP1Y	White, vinyl tape.	1.00	25.40	100.0	30.5	1	4
T100X000VQ1Y	Blue, vinyl tape.	1.00	25.40	100.0	30.5	1	4
T100X000VS1Y	Green, vinyl tape.	1.00	25.40	100.0	30.5	1	4
T100X000VU1Y	Orange, vinyl tape.	1.00	25.40	100.0	30.5	1	4
T100X000VW1Y	Red, vinyl tape.	1.00	25.40	100.0	30.5	1	4
T100X000VX1Y	Yellow, vinyl tape.	1.00	25.40	100.0	30.5	1	4
T100X000VY1Y	Black, vinyl tape.	1.00	25.40	100.0	30.5	1	4
T200X000VP1Y	White, vinyl tape.	2.00	50.80	100.0	30.5	1	4
T200X000VQ1Y	Blue, vinyl tape.	2.00	50.80	100.0	30.5	1	4
T200X000VS1Y	Green, vinyl tape.	2.00	50.80	100.0	30.5	1	4
T200X000VT1Y	Gray, vinyl tape.	2.00	50.80	100.0	30.5	1	4
T200X000VU1Y	Orange, vinyl tape.	2.00	50.80	100.0	30.5	1	4
T200X000VV1Y	Purple, vinyl tape.	2.00	50.80	100.0	30.5	1	4
T200X000VW1Y	Red, vinyl tape.	2.00	50.80	100.0	30.5	1	4
T200X000VX1Y	Yellow, vinyl tape.	2.00	50.80	100.0	30.5	1	4
T200X000VY1Y	Black, vinyl tape.	2.00	50.80	100.0	30.5	1	4
T200X000YK1	Clear, polyester tape.	2.00	50.80	100.0	30.5	1	4
T225X000YK1	Clear, polyester tape.	2.25	57.15	100.0	30.5	1	4
T400X000VP1Y	White, vinyl tape.	4.00	101.60	100.0	30.5	1	4
T400X000VQ1Y	Blue, vinyl tape.	4.00	101.60	100.0	30.5	1	4
T400X000VS1Y	Green, vinyl tape.	4.00	101.60	100.0	30.5	1	4
T400X000VT1Y	Gray, vinyl tape.	4.00	101.60	100.0	30.5	1	4
T400X000VU1Y	Orange, vinyl tape.	4.00	101.60	100.0	30.5	1	4
T400X000VV1Y	Purple, vinyl tape.	4.00	101.60	100.0	30.5	1	4
T400X000VW1Y	Red, vinyl tape.	4.00	101.60	100.0	30.5	1	4
T400X000VX1Y	Yellow, vinyl tape.	4.00	101.60	100.0	30.5	1	4
T400X000VY1Y	Black, vinyl tape.	4.00	101.60	100.0	30.5	1	4
T425X000YK1	Clear, polyester tape.	4.25	107.95	100.0	30.5	1	4

Order number of rolls required.

Use with *PANDUIT* thermal transfer ribbons.

‡Labels roll mounted on 3.00" cores; when using the TDP43MY printer and 3.00" cores, the roll stand (TDP43M-RS) is required.

A.
System
Overview

B1.
Cable
Ties

B2.
Cable
Accessories

B3.
Stainless
Steel Ties

C1.
Wiring
Duct

C2.
Surface
Raceway

C3.
Abrasion
Protection

C4.
Cable
Management

D1.
Terminals

D2.
Power
Connectors

D3.
Grounding
Connectors

E1.
Labeling
Systems

E2.
Labels

E3.
Pre-Printed
& Write-On
Markers

E4.
Permanent
Identification

E5.
Lockout/
Tagout/
& Safety
Solutions

F.
Index

A. System Overview

Dot Matrix Self-Laminating Labels

B1. Cable Ties

- High quality, economical solution for wire/cable labeling
- Meets UL 2043 suitable for use in air handling spaces
- Self-laminating labels include a colored print-on area and clear overlaminates to protect the legend for clear and durable identification

- Available in vinyl and TEDLAR® material and supplied on pin fed sheets
- PANDUIT labeling software packages include all label formats for quick and easy label production

B2. Cable Accessories



B3. Stainless Steel Ties

C1. Wiring Duct

C2. Surface Raceway

Part Number System for Self-Laminating Labels

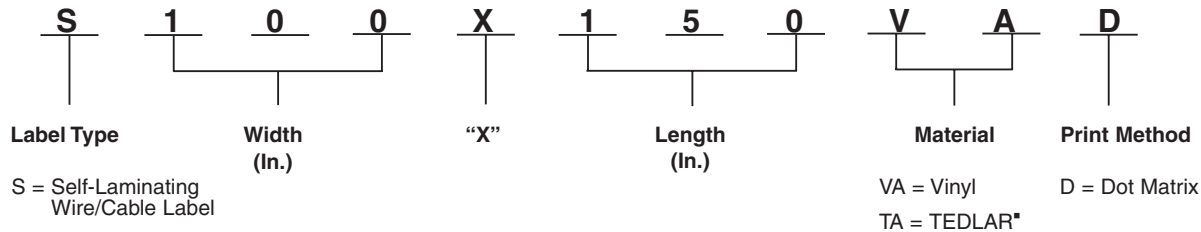

C3. Abrasion Protection

C4. Cable Management

Material/Print Method Selection Guide

Material	Print Method	Temperature Range	Features
Self-Laminating Vinyl, White Print-On (VA)	Dot Matrix (D)	-40°F to 200°F (-40°C to 93°C)	Indoor/outdoor rated; thin and conformable; preferred material for most general wire/cable labeling.
Self-Laminating TEDLAR®, White Print-On (TA)	Dot Matrix (D)	0°F to 275°F (-18°C to 135°C)	Indoor/outdoor rated; self-extinguishing; ideal for wire/cable labeling in harsh environments.

D1. Terminals

D2. Power Connectors

D3. Grounding Connectors

Part Number	Part Description	Width		Length		Print-On Height		Min. Cable O.D.		Max. Cable O.D.		Std. Pkg. Qty.	Std. Ctn. Qty.
		In.	mm	In.	mm	In.	mm	In.	mm	In.	mm		
S050X075TAD	White print-on area, TEDLAR® label.	.50	12.70	.75	19.05	.25	6.35	.12	3.07	.16	4.04	5000	25000
S050X075VADY	White print-on area, vinyl label.	.50	12.70	.75	19.05	.25	6.35	.12	3.07	.16	4.04	5000	25000
S050X125TAD	White print-on area, TEDLAR® label.	.50	12.70	1.25	31.75	.38	9.65	.12	3.07	.28	7.03	5000	20000
S050X125VADY	White print-on area, vinyl label.	.50	12.70	1.25	31.75	.38	9.65	.12	3.07	.28	7.03	5000	20000
S050X150TAD	White print-on area, TEDLAR® label.	.50	12.70	1.50	38.10	.50	12.70	.16	4.04	.32	8.09	5000	20000
S050X150VADY	White print-on area, vinyl label.	.50	12.70	1.50	38.10	.50	12.70	.16	4.04	.32	8.09	5000	20000
S100X075TAD	White print-on area, TEDLAR® label.	1.00	25.40	.75	19.05	.25	6.35	.08	2.02	.16	4.04	5000	20000
S100X075VADY	White print-on area, vinyl label.	1.00	25.40	.75	19.05	.25	6.35	.08	2.02	.16	4.04	5000	20000
S100X125TAD	White print-on area, TEDLAR® label.	1.00	25.40	1.25	31.75	.38	9.65	.12	3.07	.28	7.03	5000	20000
S100X125VADY	White print-on area, vinyl label.	1.00	25.40	1.25	31.75	.38	9.65	.12	3.07	.28	7.03	5000	20000
S100X150TAD	White print-on area, TEDLAR® label.	1.00	25.40	1.50	38.10	.50	12.70	.16	4.04	.32	8.09	5000	20000
S100X150VADY	White print-on area, vinyl label.	1.00	25.40	1.50	38.10	.50	12.70	.16	4.04	.32	8.09	5000	20000

E1. Labeling Systems

E2. Labels

E3. Pre-Printed & Write-On Markers

E4. Permanent Identification

E5. Lockout/Tagout & Safety Solutions

F. Index

Order number of labels required in multiples of Std. Pkg. Qty.
 *TEDLAR is a registered trademark of E.I. du Pont de Nemours and Company.

Dot Matrix Self-Laminating Labels (continued)

Part Number	Part Description	Width		Length		Print-On Height		Min. Cable O.D.		Max. Cable O.D.		Std. Pkg. Qty.	Std. Ctn. Qty.
		In.	mm	In.	mm	In.	mm	In.	mm	In.	mm		
S100X225TAD	White print-on area, TEDLAR® label.	1.00	25.40	2.25	57.15	.75	19.05	.24	6.06	.48	12.13	5000	25000
S100X225VADY	White print-on area, vinyl label.	1.00	25.40	2.25	57.15	.75	19.05	.24	6.06	.48	12.13	5000	25000
S100X400TAD	White print-on area, TEDLAR® label.	1.00	25.40	4.00	101.60	1.00	25.40	.32	8.09	.95	24.26	1000	4000
S100X400VADY	White print-on area, vinyl label.	1.00	25.40	4.00	101.60	1.00	25.40	.32	8.09	.95	24.26	1000	4000
S100X650TAD	White print-on area, TEDLAR® label.	1.00	25.40	6.50	165.10	1.50	38.10	.48	12.13	1.59	40.43	1000	2000
S100X650VADY	White print-on area, vinyl label.	1.00	25.40	6.50	165.10	1.50	38.10	.48	12.13	1.59	40.43	1000	2000
S200X225TAD	White print-on area, TEDLAR® label.	2.00	50.80	2.25	57.15	.75	19.05	.24	6.06	.48	12.13	5000	20000
S200X225VADY	White print-on area, vinyl label.	2.00	50.80	2.25	57.15	.75	19.05	.24	6.06	.48	12.13	5000	20000
S200X400TAD	White print-on area, TEDLAR® label.	2.00	50.80	4.00	101.60	1.00	25.40	.32	8.09	.95	24.26	1000	4000
S200X400VADY	White print-on area, vinyl label.	2.00	50.80	4.00	101.60	1.00	25.40	.32	8.09	.95	24.26	1000	4000
S200X650TAD	White print-on area, TEDLAR® label.	2.00	50.80	6.50	165.10	1.50	38.10	.48	12.13	1.59	40.43	1000	4000
S200X650VADY	White print-on area, vinyl label.	2.00	50.80	6.50	165.10	1.50	38.10	.48	12.13	1.59	40.43	1000	4000

Order number of labels required in multiples of Std. Pkg. Qty.

*TEDLAR is a registered trademark of E.I. du Pont de Nemours and Company.

A.
System
Overview

B1.
Cable Ties

B2.
Cable
Accessories

B3.
Stainless
Steel Ties

C1.
Wiring
Duct

C2.
Surface
Raceway

C3.
Abrasion
Protection

C4.
Cable
Management

D1.
Terminals

D2.
Power
Connectors

D3.
Grounding
Connectors

E1.
Labeling
Systems

E2.
Labels

E3.
Pre-Printed
& Write-On
Markers

E4.
Permanent
Identification

E5.
Lockout/
Tagout/
& Safety
Solutions

F.
Index

A. System Overview

Dot Matrix Non-Laminated Labels

B1. Cable Ties

- High quality, economical solution for wire/cable labeling
- Use as a wrap-around label or flag style marker for wire/cable labeling

- Available in vinyl cloth material and supplied on pin fed sheets
- **PANDUIT** labeling software packages include all label formats for quick and easy label production

B2. Cable Accessories



B3. Stainless Steel Ties

C1. Wiring Duct

Part Number System for Non-Laminated Labels

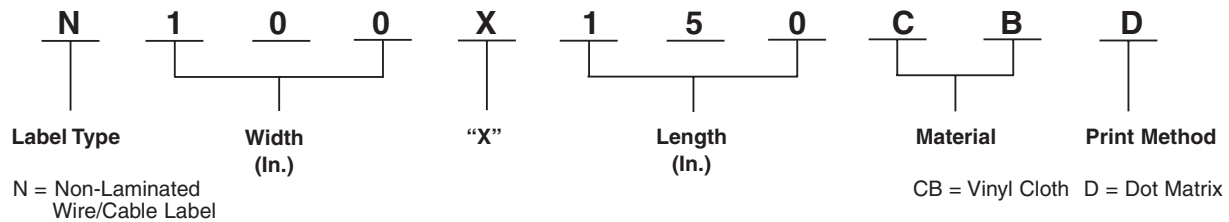

C2. Surface Raceway

C3. Abrasion Protection

C4. Cable Management

Material/Print Method Selection Guide

Material	Print Method	Temperature Range	Features
Vinyl Cloth, White (CB)	Dot Matrix (D)	-50°F to 170°F (-46°C to 77°C)	Indoor/outdoor rated; thin conformable material with repositionable adhesive allows label to be removed and reused or used in temporary applications; provides durability, high temperature resistance, and dimensional stability for rough or textured surface.

D1. Terminals

D2. Power Connectors

D3. Grounding Connectors

Part Number	Part Description	Width		Length		Min. Cable O.D.		Max. Cable O.D.		Std. Pkg. Qty.	Std. Ctn. Qty.
		In.	mm	In.	mm	In.	mm	In.	mm		
N025X075CBD	White, vinyl cloth label.	.25	6.35	.75	19.05	.24	6.10	.51	12.95	5000	20000
N025X125CBD	White, vinyl cloth label.	.25	6.35	1.25	31.75	.40	10.16	.85	21.59	5000	20000
N025X150CBD	White, vinyl cloth label.	.25	6.35	1.50	38.10	.48	12.19	1.02	25.91	5000	20000
N025X175CBD	White, vinyl cloth label.	.25	6.35	1.75	44.45	.56	14.22	1.19	30.23	5000	20000
N050X075CBD	White, vinyl cloth label.	.50	12.70	.75	19.05	.24	6.10	.51	12.95	5000	15000
N050X100CBD	White, vinyl cloth label.	.50	12.70	1.00	25.40	.32	8.13	.68	17.27	5000	20000
N050X125CBD	White, vinyl cloth label.	.50	12.70	1.25	31.75	.40	10.16	.85	21.59	5000	20000
N050X150CBD	White, vinyl cloth label.	.50	12.70	1.50	38.10	.48	12.19	1.02	25.91	5000	10000
N050X175CBD	White, vinyl cloth label.	.50	12.70	1.75	44.45	.56	14.22	1.19	30.23	5000	10000
N100X075CBD	White, vinyl cloth label.	1.00	25.40	.75	19.05	.24	6.10	.51	12.95	5000	20000
N100X125CBD	White, vinyl cloth label.	1.00	25.40	1.25	31.75	.40	10.16	.85	21.59	5000	20000
N100X150CBD	White, vinyl cloth label.	1.00	25.40	1.50	38.10	.48	12.19	1.02	25.91	5000	15000
N100X175CBD	White, vinyl cloth label.	1.00	25.40	1.75	44.45	.56	14.22	1.19	30.23	5000	15000

E1. Labeling Systems

E2. Labels

E3. Pre-Printed & Write-On Markers

E4. Permanent Identification

E5. Lockout/Tagout & Safety Solutions

F. Index

Order number of labels required in multiples of Std. Pkg. Qty.

A.
System
Overview

Dot Matrix Component Labels (continued)

B1.
Cable Ties



B2.
Cable
Accessories

B3.
Stainless
Steel Ties

C1.
Wiring
Duct

C2.
Surface
Raceway

C3.
Abrasion
Protection

C4.
Cable
Management

D1.
Terminals

D2.
Power
Connectors

D3.
Grounding
Connectors

E1.
Labeling
Systems

E2.
Labels

E3.
Pre-Printed
& Write-On
Markers

E4.
Permanent
Identification

E5.
Lockout/
Tagout/
& Safety
Solutions

F.
Index

Part Number	Part Description	Width		Height		Std. Pkg. Qty.	Std. Ctn. Qty.
		In.	mm	in.	mm		
C025X025YJD	White, polyester label.	.25	6.35	.25	6.35	5000	25000
C038X038YJD	White, polyester label.	.38	9.65	.38	9.65	5000	25000
C050X044CBD	White, vinyl cloth label.	.50	12.70	.44	11.18	5000	25000
C050X044YJD	White, polyester label.	.50	12.70	.44	11.18	5000	25000
C060X020CBD	White, vinyl cloth label.	.60	15.24	.20	5.08	5000	25000
C060X020YJD	White, polyester label.	.60	15.24	.20	5.08	5000	25000
C075X025CBD	White, vinyl cloth label.	.75	19.05	.25	6.35	5000	25000
C075X025YJD	White, polyester label.	.75	19.05	.25	6.35	5000	25000
C080X020YJD	White, polyester label.	.80	20.32	.20	5.08	5000	25000
C100X025CBD	White, vinyl cloth label.	1.00	25.40	.25	6.35	5000	20000
C100X025YJD	White, polyester label.	1.00	25.40	.25	6.35	5000	25000
C100X050CBD	White, vinyl cloth label.	1.00	25.40	.50	12.70	5000	20000
C100X050YJD	White, polyester label.	1.00	25.40	.50	12.70	5000	20000
C150X075YJD	White, polyester label.	1.50	38.10	.75	19.05	5000	10000
C160X020CBD	White, vinyl cloth label.	1.60	40.64	.20	5.08	5000	10000
C160X020YJD	White, polyester label.	1.60	40.64	.20	5.08	5000	25000
C200X050CBD	White, vinyl cloth label.	2.00	50.80	.50	12.70	5000	10000
C200X050YJD	White, polyester label.	2.00	50.80	.50	12.70	5000	10000
C200X100YJD	White, polyester label.	2.00	50.80	1.00	25.40	1000	5000
C400X100CBD	White, vinyl cloth label.	4.00	101.60	1.00	25.40	1000	3000
C400X100YJD	White, polyester label.	4.00	101.60	1.00	25.40	1000	3000
C400X200YJD	White, polyester label.	4.00	101.60	2.00	50.80	1000	3000
C400X400YJD	White, polyester label.	4.00	101.60	4.00	101.60	1000	3000

Order number of labels required in multiples of Std. Pkg. Qty.

Size Illustrations of Self-Laminating Labels

The image displays 14 different sizes of self-laminating labels, each represented by a rectangular box with a white header and a grey body. The labels are arranged in three rows:

- Row 1:** S050X075*, S050X125*, S050X150*, S075X075*, S075X125*, S075X150*, S100X075*, S100X125*
- Row 2:** S100X150*, S100X225*, S100X400*, S150X150*, S150X225*
- Row 3:** S150X400*

*Represents material type and print method of part number.

A.
System
Overview

B1.
Cable Ties

B2.
Cable
Accessories

B3.
Stainless
Steel Ties

C1.
Wiring
Duct

C2.
Surface
Raceway

C3.
Abrasion
Protection

C4.
Cable
Management

D1.
Terminals

D2.
Power
Connectors

D3.
Grounding
Connectors

E1.
Labeling
Systems

E2.
Labels

E3.
Pre-Printed
& Write-On
Markers

E4.
Permanent
Identification

E5.
Lockout/
Tagout/
& Safety
Solutions

F.
Index

Size Illustrations of Self-Laminating Labels (continued)

A. System Overview
B1. Cable Ties
B2. Cable Accessories
B3. Stainless Steel Ties
C1. Wiring Duct
C2. Surface Raceway
C3. Abrasion Protection
C4. Cable Management
D1. Terminals
D2. Power Connectors
D3. Grounding Connectors
E1. Labeling Systems
E2. Labels
E3. Pre-Printed & Write-On Markers
E4. Permanent Identification
E5. Lockout/Tagout & Safety Solutions
F. Index

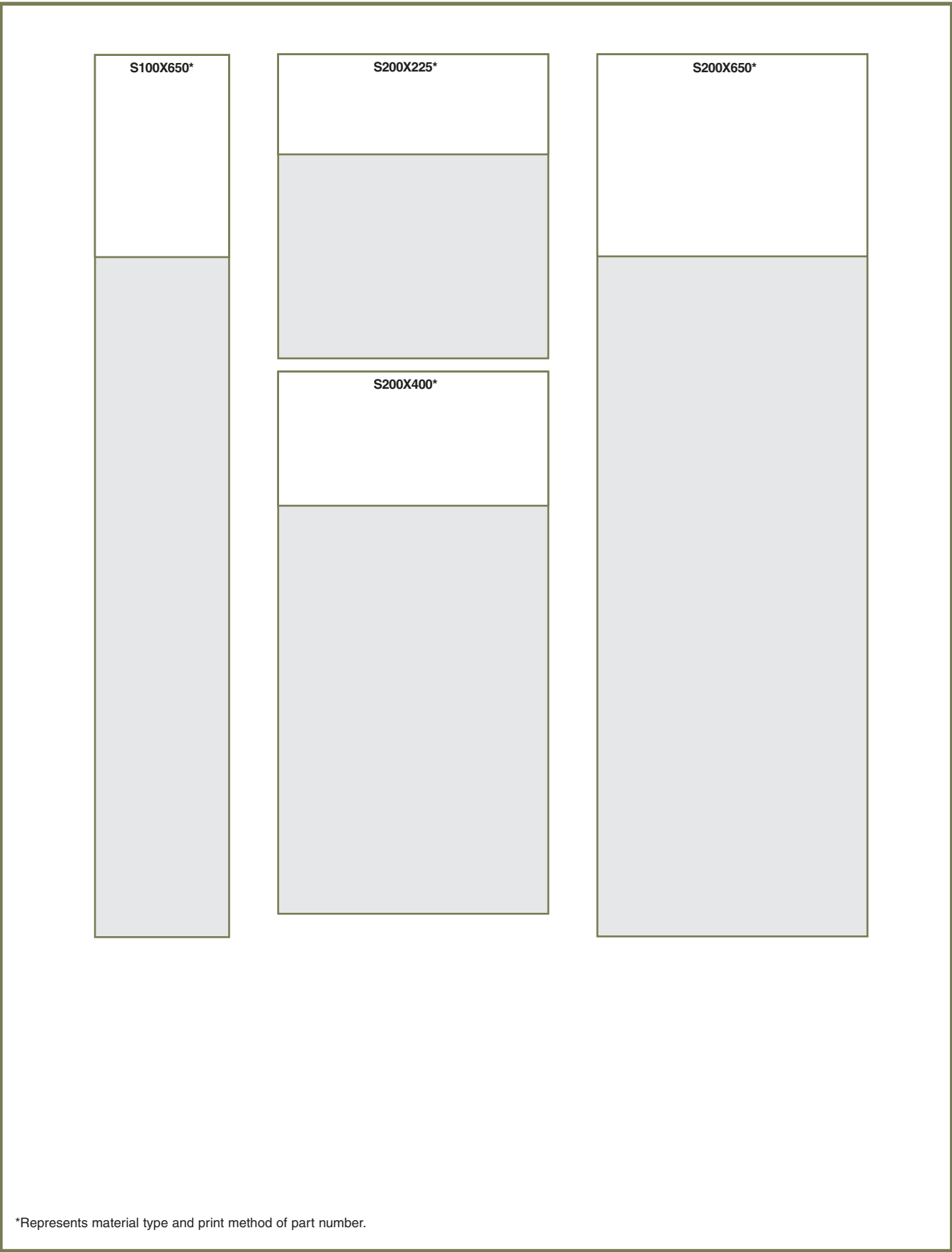

*Represents material type and print method of part number.

Size Illustrations of Non-Laminated and Flag Style Labels

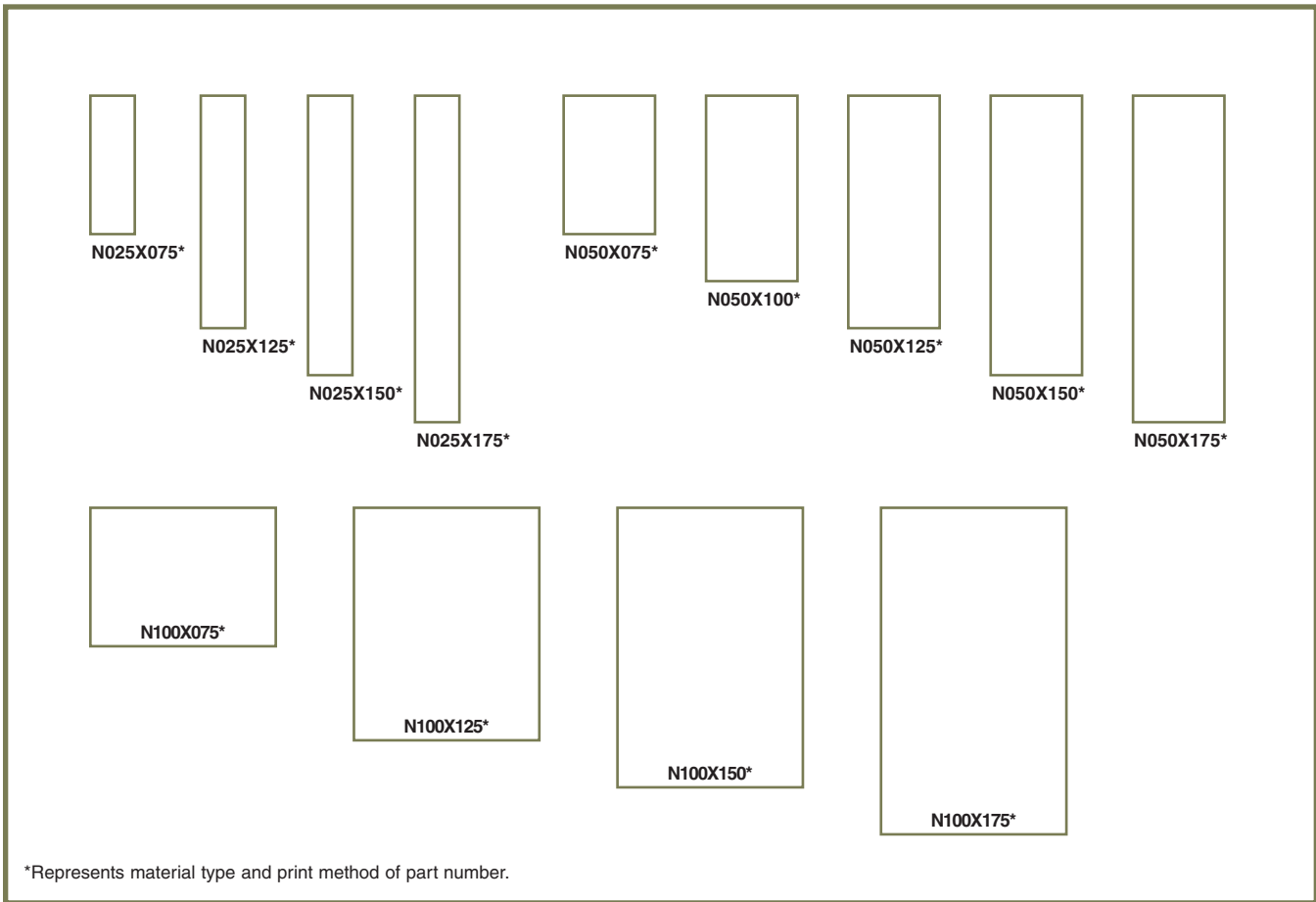

A.
System
Overview

B1.
Cable Ties

B2.
Cable
Accessories

B3.
Stainless
Steel Ties

C1.
Wiring
Duct

C2.
Surface
Raceway

C3.
Abrasion
Protection

C4.
Cable
Management

D1.
Terminals

D2.
Power
Connectors

D3.
Grounding
Connectors

E1.
Labeling
Systems

E2.
Labels

E3.
Pre-Printed
& Write-On
Markers

E4.
Permanent
Identification

E5.
Lockout/
Tagout
& Safety
Solutions

F.
Index

Size Illustrations of Flattened Heat Shrink Labels

A.
System
Overview

B1.
Cable Ties

B2.
Cable
Accessories

B3.
Stainless
Steel Ties

C1.
Wiring
Duct

C2.
Surface
Raceway

C3.
Abrasion
Protection

C4.
Cable
Management

D1.
Terminals

D2.
Power
Connectors

D3.
Grounding
Connectors

E1.
Labeling
Systems

E2.
Labels

E3.
Pre-Printed
& Write-On
Markers

E4.
Permanent
Identification

E5.
Lockout/
Tagout/
& Safety
Solutions

F.
Index

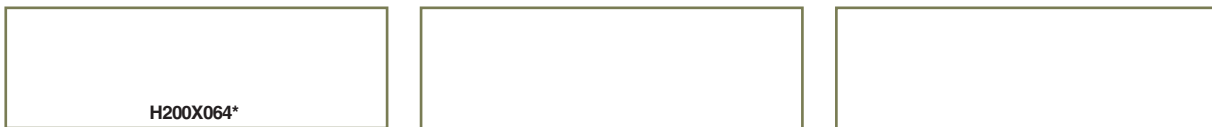
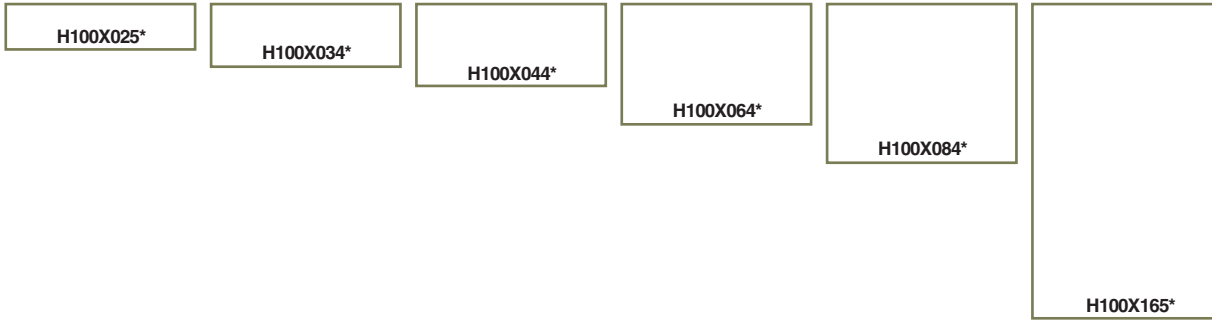

*Represents material type and print method of part number.

Size Illustrations for Component Labels

The following table lists the part numbers and their corresponding dimensions as shown in the illustrations:

Part Number	Dimensions (Approximate)
C025X025*	Small square
C038X038*	Small square
C050X044*	Small square
C060X020*	Small horizontal rectangle
C075X025*	Small horizontal rectangle
C080X020*	Small horizontal rectangle
C100X025*	Small horizontal rectangle
C100X050*	Medium horizontal rectangle
C150X075*	Medium horizontal rectangle
C160X020*	Small horizontal rectangle
C200X050*	Medium horizontal rectangle
C200X075*	Medium horizontal rectangle
C200X100*	Medium horizontal rectangle
C300X100*	Large horizontal rectangle
C400X100*	Large horizontal rectangle
C400X200*	Large horizontal rectangle
C225X450*	Very large vertical rectangle

*Represents material type and print method of part number.

A.
System
Overview

B1.
Cable
Ties

B2.
Cable
Accessories

B3.
Stainless
Steel Ties

C1.
Wiring
Duct

C2.
Surface
Raceway

C3.
Abrasion
Protection

C4.
Cable
Management

D1.
Terminals

D2.
Power
Connectors

D3.
Grounding
Connectors

E1.
Labeling
Systems

E2.
Labels

E3.
Pre-Printed
& Write-On
Markers

E4.
Permanent
Identification

E5.
Lockout/
Tagout/
& Safety
Solutions

F.
Index

Size Illustrations for Component Labels (continued)

A.
System
Overview

B1.
Cable Ties

B2.
Cable
Accessories

B3.
Stainless
Steel Ties

C1.
Wiring
Duct

C2.
Surface
Raceway

C3.
Abrasion
Protection

C4.
Cable
Management

D1.
Terminals

D2.
Power
Connectors

D3.
Grounding
Connectors

E1.
Labeling
Systems

E2.
Labels

E3.
Pre-Printed
& Write-On
Markers

E4.
Permanent
Identification

E5.
Lockout/
Tagout/
& Safety
Solutions

F.
Index

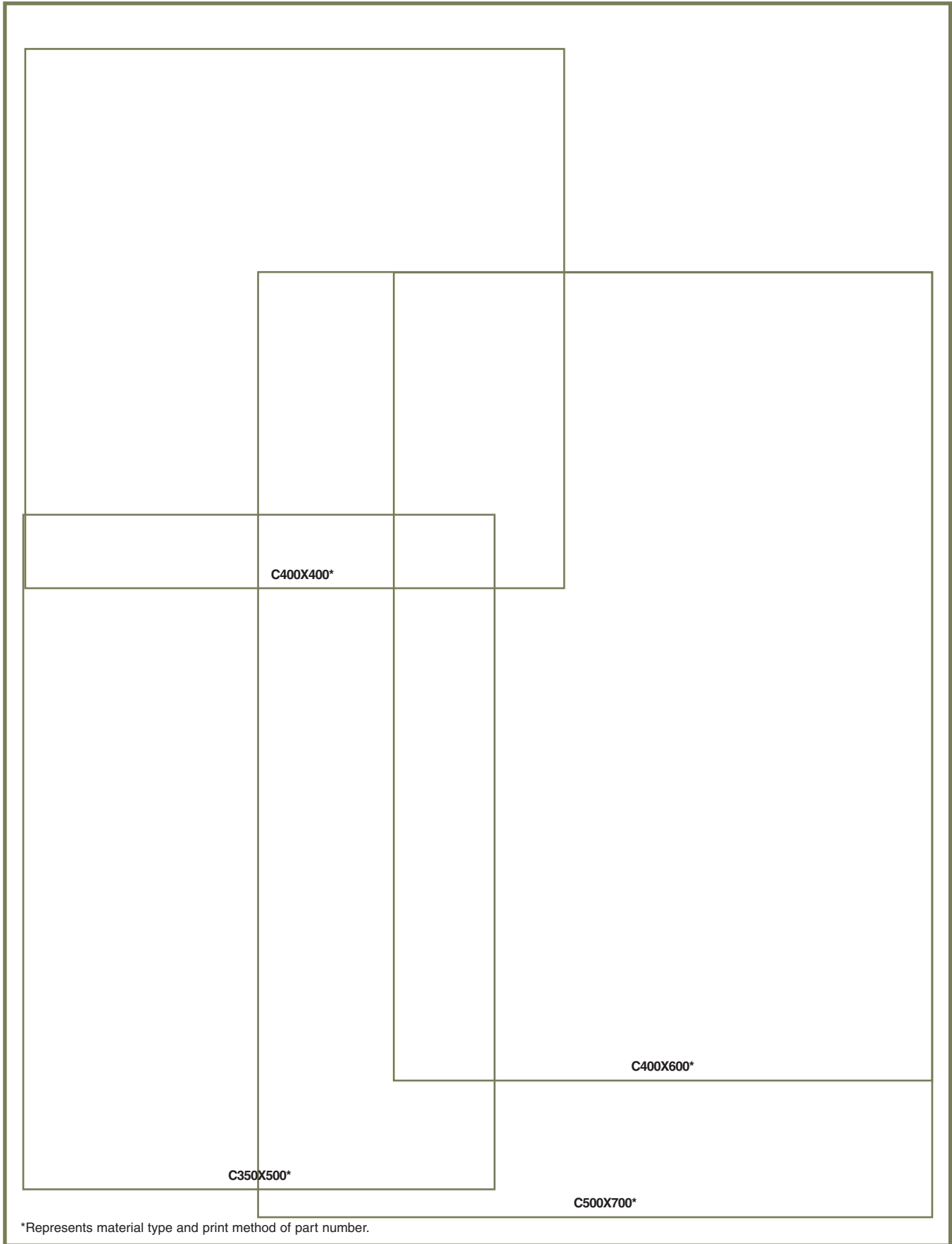

*Represents material type and print method of part number.

PRE-PRINTED AND WRITE-ON MARKERS

PANDUIT offers a variety of pre-printed and write-on marker solutions in multiple formats to meet your specific requirements.



- Marker books are a convenient pocket-sized method to identify many electrical and network components
- Marker cards are available in a variety of legends and combination packs
- Dispensers are available in both pre-printed and write-on formats for quick identification of wire/cable
- Clip-on markers provide a fast, convenient, non-adhesive method to identify wire/cable

PANDUIT offers a variety of innovative books, cards, clip-ons and dispensers to provide you with the wire/cable label that best fits your needs.

A.
System
Overview

B1.
Cable Ties

B2.
Cable
Accessories

B3.
Stainless
Steel Ties

C1.
Wiring
Duct

C2.
Surface
Raceway

C3.
Abrasion
Protection

C4.
Cable
Management

D1.
Terminals

D2.
Power
Connectors

D3.
Grounding
Connectors

E1.
Labeling
Systems

E2.
Labels

E3.
Pre-Printed
& Write-On
Markers

E4.
Permanent
Identification

E5.
Lockout/
Tagout/
& Safety
Solutions

F.
Index

A. System Overview

Pre-Printed Marker Books

B1. Cable Ties

- Convenient, pocket-sized book
- Markers are perforated and can be torn in half to mark both ends of conductors
- Terminal block markers are included to properly identify connectors
- Ten pages of markers per book

B2. Cable Accessories

B3. Stainless Steel Ties

C1. Wiring Duct

C2. Surface Raceway

C3. Abrasion Protection

C4. Cable Management

D1. Terminals

D2. Power Connectors

D3. Grounding Connectors

E1. Labeling Systems

E2. Labels

E3. Pre-Printed & Write-On Markers

E4. Permanent Identification

E5. Lockout/Tagout & Safety Solutions

F. Index

Material Chart

Material	Print Method	Temperature Range	Features
Vinyl Cloth, White	Pre-Printed	-50°F to 170°F (-46°C to 77°C)	Indoor/outdoor rated; conformable material with repositionable adhesive allows label to be removed and reused or used in temporary applications; provides durability, high temperature resistance, and dimensional stability for rough or textured surfaces; resists oil and abrasion.

Perforation for half marker

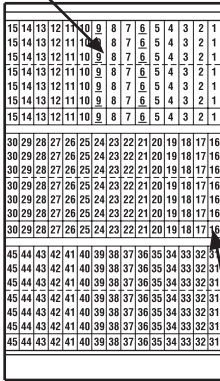

Terminal Block Marker

Part Number	Legend	Total Markers Each Legend	Std. Pkg. Book(s)	Std. Ctn. Book(s)
PCMB-1	0 thru 9	45	1	10
PCMB-2	A thru Z, 0 thru 15, +, -, /	10	1	10
PCMB-3	1 thru 45	10	1	10
PCMB-4	1, 2, 3	150	1	10
PCMB-5	A, B, C	150	1	10
PCMB-6	T1, T2, T3	150	1	10
PCMB-7	L1, L2, L3	150	1	10
PCMB-8	1 thru 15 16 thru 90 A thru Z, +, -, /, 0	6 4 2	1	10
PCMB-9	1, 2, 3, A, B, C L1, L2, L3, T1, T2, T3	45 30	1	10
PCMB-10	Solid NEMA colors red, yellow, white, light blue, light green, black, brown, orange, gray, dark green	45	1	10
PCMB-11	1 thru 30	15	1	10
PCMB-12	A thru Z + - Blank (write-on)	15 8 7 21	1	10
PCMB-13	+ , - , AC, DC POS, NEG, GND NEUT SPARE, Blank (write-on)	45 33 27 21	1	10
PCMB-14	46 thru 90	10	1	10
PCMB-15	0 thru 45, +, -	10	1	10
PCMB-16	0 thru 33, A, B, C, +, -, L1, L2, L3, T1, T2, T3	10	1	10
PCMB-25	0 thru 9 L1, L2, L3, T1, T2, T3	45 15	1	10

Legend: Black Background: White

Marker sizes:

Full size marker – .22" x 1.38" (5.60mm x 34.90mm). Maximum wire O.D., .38" (9.50mm).

Half size marker – .22" x .69" (5.60mm x 17.40mm). Maximum wire O.D., .19" (4.70mm).

Terminal block marker – .22" x .25" (5.60mm x 6.30mm).

A. System Overview

Pre-Printed Marker Cards PCM Type

B1. Cable Ties

- Marker cards printed in a variety of legends allows “kitting” for project builds

- Plastic liner provides easy removal of markers while protecting unused markers

B2. Cable Accessories

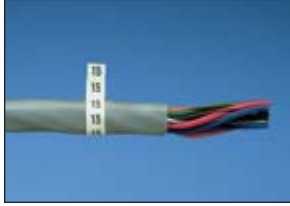

B3. Stainless Steel Ties

C1. Wiring Duct

Material Chart

Material	Print Method	Temperature Range	Features
Vinyl Cloth, White	Pre-Printed	-50°F to 170°F (-46°C to 77°C)	Indoor/outdoor rated; conformable material with repositionable adhesive allows label to be removed and reused or used in temporary applications; provides durability, high temperature resistance, and dimensional stability for rough or textured surfaces; resists oil and abrasion.

C2. Surface Raceway

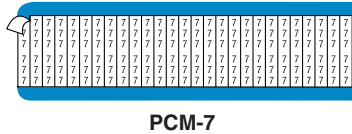

PCM-7

C3. Abrasion Protection

C4. Cable Management

D1. Terminals

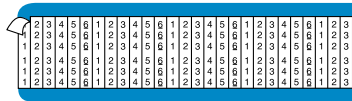

PCM-1-6

D2. Power Connectors

D3. Grounding Connectors

E1. Labeling Systems

E2. Labels

E3. Pre-Printed & Write-On Markers

E4. Permanent Identification

E5. Lockout/Tagout & Safety Solutions

F. Index

Part Number	Legend	Width		Length		Markers Per Card	Std. Pkg. Card(s)	Std. Ctn. Card(s)	
		In.	mm	In.	mm				
PCM-0 thru PCM-99	0 thru 99	.25	6.40	1.50	38.10	36	25	100	
PCM-100 thru PCM-202	100 thru 202	.36	9.10	1.50	38.10	25	25	100	
PCMH-0 thru PCMH-25	0 thru 25	.25	6.40	1.50	38.10	72	25	100	
PCM-1-3	1 thru 3	.25	6.40	1.50	38.10	36	25	100	
PCM-1-4	1 thru 4	.25	6.40	1.50	38.10		25	100	
PCM-1-5	1 thru 5	.25	6.40	1.50	38.10		25	100	
PCM-1-6	1 thru 6	.25	6.40	1.50	38.10		25	100	
PCM-1-8	1 thru 8	.25	6.40	1.50	38.10		25	100	
PCM-1-9	1 thru 9	.25	6.40	1.50	38.10		25	100	
PCM-0-9	0 thru 9	.25	6.40	1.50	38.10		25	100	
PCM-1-10	1 thru 10	.25	6.40	1.50	38.10		25	100	
PCM-1-12	1 thru 12	.25	6.40	1.50	38.10		25	100	
PCM-1-16	1 thru 16	.25	6.40	1.50	38.10		25	100	
PCM-1-18	1 thru 18	.25	6.40	1.50	38.10		25	100	
PCM-19-36	19 thru 36	.25	6.40	1.50	38.10		25	100	
PCM-1-33	1 thru 33	.25	6.40	1.50	38.10		33	25	100
PCM-34-66	34 thru 66	.25	6.40	1.50	38.10			25	100
PCM-67-99	67 thru 99	.25	6.40	1.50	38.10			25	100
PCM-100-124	100 thru 124	.36	9.10	1.50	38.10		25	25	100
PCM-125-149	125 thru 149	.36	9.10	1.50	38.10	25		100	
PCM-150-174	150 thru 174	.36	9.10	1.50	38.10	25		100	
PCM-175-199	175 thru 199	.36	9.10	1.50	38.10	25		100	

Pre-Printed Marker Cards PCM Type (continued)



PCM-A1

Part Number	Legend	Width		Length		Markers Per Card	Std. Pkg. Card(s)	Std. Ctn. Card(s)
		In.	mm	In.	mm			
PCM-A thru PCM-Z	A thru Z	.25	6.40	1.50	38.10	36	25	100
PCM-A-Z	A thru Z	.25	6.40	1.50	38.10		25	100
PCM-A-Z-0-9	A thru Z 0 thru 9	.25	6.40	1.50	38.10		25	100
PCM-A1 thru PCM-A4	A1 thru A4	.25	6.40	1.50	38.10		25	100
PCM-A1 thru PCM-B5	B1 thru B5	.25	6.40	1.50	38.10		25	100
PCM-C1 thru PCM-C4	C1 thru C4	.25	6.40	1.50	38.10		25	100
PCM-E1 thru PCM-E3	E1 thru E3	.25	6.40	1.50	38.10		25	100
PCM-F1 thru PCM-F4	F1 thru F4	.25	6.40	1.50	38.10		25	100
PCM-H1 thru PCM-H5	H1 thru H5	.25	6.40	1.50	38.10		25	100
PCM-L1 thru PCM-L5	L1 thru L5	.25	6.40	1.50	38.10		25	100
PCM-M1 thru PCM-M2	M1 thru M2	.25	6.40	1.50	38.10		25	100
PCM-P1 thru PCM-P3	P1 thru P3	.25	6.40	1.50	38.10		25	100
PCM-R1 thru PCM-R5	R1 thru R5	.25	6.40	1.50	38.10		25	100
PCM-S1 thru PCM-S5	S1 thru S5	.25	6.40	1.50	38.10		25	100
PCM-T1 thru PCM-T9	T1 thru T9	.25	6.40	1.50	38.10		25	100
PCM-X1 thru PCM-X4	X1 thru X4	.25	6.40	1.50	38.10		25	100

A.
System
Overview

B1.
Cable Ties

B2.
Cable
Accessories

B3.
Stainless
Steel Ties

C1.
Wiring
Duct

C2.
Surface
Raceway

C3.
Abrasion
Protection

C4.
Cable
Management

D1.
Terminals

D2.
Power
Connectors

D3.
Grounding
Connectors

E1.
Labeling
Systems

E2.
Labels

E3.
Pre-Printed
& Write-On
Markers

E4.
Permanent
Identification

E5.
Lockout/
Tagout
& Safety
Solutions

F.
Index

Table continues on page E3.6

A. System Overview

Pre-Printed Marker Cards PCM Type (continued)

B1. Cable Ties

B2. Cable Accessories

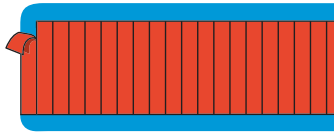

B3. Stainless Steel Ties

C1. Wiring Duct

C2. Surface Raceway

C3. Abrasion Protection

C4. Cable Management

D1. Terminals

Wire Marker Card Number Combination Packs

D2. Power Connectors



Numbers

D3. Grounding Connectors



Letters

E1. Labeling Systems

E2. Labels

E3. Pre-Printed & Write-On Markers

E4. Permanent Identification

E5. Lockout/Tagout & Safety Solutions

F. Index

Part Number	Color	Width		Length		Markers Per Card	Std. Pkg. Card(s)	Std. Ctn. Card(s)
		In.	mm	In.	mm			
PCM-BLK	Black	.25	6.40	1.50	38.10	36	25	100
PCM-BRN	Brown	.25	6.40	1.50	38.10		25	100
PCM-DBL	Dark Blue	.25	6.40	1.50	38.10		25	100
PCM-DGN	Dark Green	.25	6.40	1.50	38.10		25	100
PCM-GRY	Gray	.25	6.40	1.50	38.10		25	100
PCM-LBL	Light Blue	.25	6.40	1.50	38.10		25	100
PCM-LGN	Light Green	.25	6.40	1.50	38.10		25	100
PCM-ORN	Orange	.25	6.40	1.50	38.10		25	100
PCM-PNK	Pink	.25	6.40	1.50	38.10		25	100
PCM-PUR	Purple	.25	6.40	1.50	38.10		25	100
PCM-RED	Red	.25	6.40	1.50	38.10		25	100
PCM-TAN	Tan	.25	6.40	1.50	38.10		25	100
PCM-WHT	White	.25	6.40	1.50	38.10		25	100
PCM-YEL	Yellow	.25	6.40	1.50	38.10		25	100

Marker size:

Full size marker – 1.50" (38.10mm). Maximum wire O.D., .38" (9.50mm).

D1. Terminals

D2. Power Connectors

D3. Grounding Connectors

E1. Labeling Systems

E2. Labels

E3. Pre-Printed & Write-On Markers

E4. Permanent Identification

E5. Lockout/Tagout & Safety Solutions

F. Index

Part Number	Legend	Cards Per Legend	Markers Per Card	Std. Pkg. Qty.	Std. Ctn. Qty.
PCMCP-1-25*	1 thru 25	1 each	36	1	4
PCMCP-26-50*	26 thru 50	1 each		1	4
PCMCP-51-75*	51 thru 75	1 each		1	4
PCMCP-76-100*	76 thru 100	1 each		1	4
PCMCP-101-125*	101 thru 125	1 each	25	1	4
PCMCP-126-150*	126 thru 150	1 each		1	4
PCMCP-A-Z**	A thru Z	1 each		36	1

Marker size:

Full size marker – 1.50" (38.10mm). Maximum wire O.D., .38" (9.50mm).

*One card each number, 25 cards per package.

**One card each letter, 26 cards per package.

Pre-Printed Marker Cards

- Choose from the many legends available in general purpose vinyl cloth, or from special materials available to meet a variety of application environments
- All markers are offered in full size – 1.50" (38.1mm) long for wire outside diameter up to 0.38" (9.5mm); half size markers for wire outside diameter up to 0.19" (4.7mm) can be ordered
- Each marker on card has a different legend

Material Chart



PSM-7

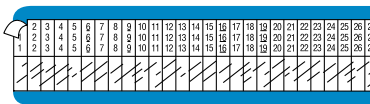

PSM-1-33



PSM-W

Material	Print Method	Temperature Range	Features
Self-Laminating Vinyl, White Print-On	Pre-Printed	-40°F to 150°F (-40°C to 66°C)	Indoor/outdoor rated; thin and conformable; preferred material for most general wire/cable labeling.

Part Number	Legend	Width		Length		Markers Per Card	Std. Pkg. Card(s)	Std. Ctn. Card(s)
		In.	mm	In.	mm			
PSM-0-Y thru PSM-52-Y	0 thru 52	.25	6.40	.75	19.10	36	25	100
PSM-0-9-Y	0 thru 9	.25	6.40	.75	19.10		25	100
PSM-1-33-Y	1 thru 33	.25	6.40	.75	19.10	33	25	100
PSM-34-66-Y	34 thru 66	.25	6.40	.75	19.10		25	100
PSM-67-99-Y	67 thru 99	.25	6.40	.75	19.10	36	25	100
PSM-A-Y thru PSM-Z	A thru Z	.25	6.40	.75	19.10		25	100
PSM-A-Z-Y	A thru Z	.25	6.40	.75	19.10		25	100

Legend: Black Background: White

Marker sizes:

Full size marker – 1.50" (38.10mm). Maximum wire O.D., .38" (9.50mm).

Half size marker – .75" (19.10mm). Maximum wire O.D., .19" (4.70mm).

A. System Overview

B1. Cable Ties

B2. Cable Accessories

B3. Stainless Steel Ties

C1. Wiring Duct

C2. Surface Raceway

C3. Abrasion Protection

C4. Cable Management

D1. Terminals

D2. Power Connectors

D3. Grounding Connectors

E1. Labeling Systems

E2. Labels

E3. Pre-Printed & Write-On Markers

E4. Permanent Identification

E5. Lockout/Tagout & Safety Solutions

F. Index

A. System Overview

Pre-Printed Marker Cards PPM Type

B1. Cable Ties

B2. Cable Accessories

B3. Stainless Steel Ties

Material Chart



PPM-7

Material	Print Method	Temperature Range	Features
TEDLAR®, White	Pre-Printed	-40°F to 275°F (-40°C to 135°C)	Indoor/outdoor rated; self-extinguishing; ideal for component labeling in harsh environments.

*TEDLAR is a registered trademark of E.I. du Pont de Nemours and Company.

C1. Wiring Duct



PPM-1-33

Part Number	Legend	Width		Length		Markers Per Card	Std. Pkg. Card(s)	Std. Ctn. Card(s)
		In.	mm	In.	mm			
PPM-0 thru PPM-25	0 thru 25	.25	6.40	1.50	38.10	36	25	100
PPM-1-33	1 thru 33	.25	6.40	1.50	38.10	33	25	100
PPM-A thru PPM-C	A thru C	.25	6.40	1.50	38.10	36	25	100

Legend: Black Background: White
 Marker sizes:
 Half size marker – 1.50" (38.10mm). Maximum wire O.D., .38" (9.50mm).

C4. Cable Management

D1. Terminals

D2. Power Connectors

D3. Grounding Connectors

E1. Labeling Systems

E2. Labels

E3. Pre-Printed & Write-On Markers

E4. Permanent Identification

E5. Lockout/Tagout & Safety Solutions

F. Index

Write-On Marker Cards – Self-Laminating

- Clear section of marker overlaminates and protects write-on legend
- Markers have ink receptive area to allow hand-written legends

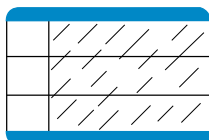

Type PSCC



Type PSWM



Type PSWMH

Part Number	Width		Length		Print-On Height		Min. Cable O.D.		Max. Cable O.D.		Markers Per Card	Std. Pkg. Card(s)	Std. Ctn. Card(s)
	In.	mm	In.	mm	In.	mm	In.	mm	In.	mm			
PSCC-3Y	1.00	25.40	3.00	76.20	.75	19.10	.24	6.06	.72	18.19	3	25	100
PSCC-5Y	1.00	25.40	5.00	127.00	1.00	25.40	.32	8.09	1.27	32.34	3	25	100
PSWMH-375Y	.38	9.50	.75	19.10	.38	9.50	.12	3.07	.12	2.99	50	25	100
PSWM-375Y	.38	9.50	1.5	38.10	.75	19.10	.24	6.06	.24	6.06	25	25	100
PSWM-750Y	.75	19.10	1.5	38.10	.75	19.10	.24	6.06	.24	6.06	12	25	100
PSWMH-750Y	.75	19.10	.75	19.10	.38	9.50	.12	3.07	.12	2.99	24	25	100
PSWM-1500Y	1.5	38.10	1.5	38.10	.75	19.10	.24	6.06	.24	6.06	6	25	100

Pre-Printed Marker Tape Dispenser

- Flexible polyester marker tape conforms tightly to wires/cables
- Dispenser allows marker tape to be cut to the exact length required for marking any size wire/cable
- Durable plastic dispenser can be attached to tool belt for industrial use



Material Chart

Material	Print Method	Temperature Range	Features
Polyester, White	Pre-Printed	-40°F to 250°F (-40°C to 121°C)	Indoor/outdoor rated; laminated label material protects legend from abrasion and chemicals; resistant to UV light chemical atmosphere and abrasion; excellent life and adhesion properties.

Part Number	Part Description	Roll		Rolls Per Legend Per Pkg.	Std. Pkg. Qty.	Std. Ctn. Qty.
		Ft.	m			
PMD	Empty dispenser.	—	—	—	1	10
PMD-0-9	Dispenser filled with one roll each legend 0 thru 9.	8.0	2.4	1	1	10
PMD-NEMA	Dispenser filled with one roll each of solid NEMA colors: black, light blue, brown, gray, light green, orange, purple, red, white and yellow.	8.0	2.4	1	1	10

A.
System
Overview

B1.
Cable Ties

B2.
Cable
Accessories

B3.
Stainless
Steel Ties

C1.
Wiring
Duct

C2.
Surface
Raceway

C3.
Abrasion
Protection

C4.
Cable
Management

D1.
Terminals

D2.
Power
Connectors

D3.
Grounding
Connectors

E1.
Labeling
Systems

E2.
Labels

E3.
Pre-Printed
& Write-On
Markers

E4.
Permanent
Identification

E5.
Lockout/
Tagout
& Safety
Solutions

F.
Index

A.
System
Overview

Pre-Printed Marker Tape Refills

B1.
Cable Ties



B2.
Cable
Accessories

B3.
Stainless
Steel Ties



C1.
Wiring
Duct

C2.
Surface
Raceway

C3.
Abrasion
Protection

C4.
Cable
Management

D1.
Terminals

D2.
Power
Connectors

D3.
Grounding
Connectors

E1.
Labeling
Systems

E2.
Labels

E3.
Pre-Printed
& Write-On
Markers

E4.
Permanent
Identification

E5.
Lockout/
Tagout/
& Safety
Solutions

F.
Index

Part Number	Legend	Roll Length		Rolls Per Legend Per Pkg.	Std. Pkg. Roll(s)	Std. Ctn. Roll(s)			
		Ft.	m						
PMDR-0-9 thru PMDR-90-99	0 thru 9 thru 90 thru 99	8.0	2.4	10	1	10			
PMDR-0 thru PMDR-9	0 thru 9				10	100			
PMDR-A thru PMDR-Z	A thru Z				10	100			
PMDR-L1 thru PMDR-L3	L1 thru L3				10	100			
PMDR-T1 thru PMDR-T3	T1 thru T3				10	100			
PMDR-GRS	Ground symbol				8.0	2.4	10	10	100
PMDR-MIN	Minus symbol							10	100
PMDR-PLS	Plus symbol							10	100
PMDR-BLK	Black							10	100
PMDR-BL	Light Blue							10	100
PMDR-BRN	Brown	10	100						
PMDR-GRN	Light Green	10	100						
PMDR-GRY	Gray	10	100						
PMDR-ORN	Orange	10	100						
PMDR-PUR	Purple	10	100						
PMDR-RED	Red	10	100						
PMDR-WHT	White	10	100						
PMDR-YEL	Yellow	10	100						
PMDR-NEMA	One of each of the NEMA colors featured above	1	1	10					

Self-Laminating Wire Marker Dispenser

- Self-laminating labels are provided in handy dispenser which protects markers when not in use
- Clear section of marker overlaminates and protects write-on legend
- Quick, easy to use for smaller installations and maintenance



Material Chart

Material	Print Method	Temperature Range	Features
Self-Laminating Vinyl, White Print-On	Pre-Printed	-40°F to 150°F (-40°C to 66°C)	Indoor/outdoor rated; thin and conformable; preferred material for most general wire/cable labeling.

Part Number	Part Description	Width		Length		Print-On Height		Min. Cable O.D.		Max. Cable O.D.		Std. Pkg. Qty.	Std. Ctn. Qty.
		In.	mm	In.	mm	In.	mm	In.	mm	In.	mm		
Dispenser Kit													
S100X125VARY	(1) Dispenser. (1) Roll, white write-on, vinyl label, 200/roll. (1) PFX-0 pen.	1.00	25.40	1.25	31.75	.38	9.65	.12	3.07	.28	7.03	1	10
S100X225VARY	(1) Dispenser. (1) Roll, white write-on, vinyl label, 100/roll. (1) PFX-0 pen.	1.00	25.40	2.25	57.15	.75	19.05	.24	6.06	.48	12.13	1	10
Refill Rolls													
S100X125VAFY	Replacement roll. White write-on, vinyl label, 200/roll.	1.00	25.40	1.25	31.75	.38	9.65	.12	3.07	.28	7.03	1	10
S100X225VAFY	Replacement roll. White write-on, vinyl label 100/roll.	1.00	25.40	2.25	57.15	.75	19.05	.24	6.06	.48	12.13	1	10

Can be clearly identified with PANDUIT permanent marking pens shown on page E5.19.

Pre-Printed Clip-On Wire Markers

- Non-adhesive markers grip tightly to wire/cable
- Markers supplied on application wand tool
- Chevron cut keeps multiple markers aligned
- Black legend is embossed into wire marker clip



Material Chart

Material	Print Method	Temperature Range	Features
Non-Adhesive Acetal	Pre-Printed	-22°F to 194°F (-30°C to 90°C)	Indoor/outdoor rated; durable material that has excellent resiliency to oils and solvents.

Part Number	Legend	No. of Markers Per Wand	Markers Per Pkg.	Std. Pkg. Qty.	Std. Ctn. Qty.
-------------	--------	-------------------------	------------------	----------------	----------------

Wire/Cable Diameter .08" – .10" (2.00mm – 2.50mm)

PCA07-A thru PCA07-Z	A thru Z	30	300	1	10
PCA07-A-J	A-J			1	10
PCA07-K-T	K-T			1	10
PCA07-U-Z	U-Z			1	10
PCA07-0 thru PCA07-9	0 thru 9			1	10
PCA07-0-9	0-9			1	10
PCA07-MIN	—			1	10
PCA07-PLS	+			1	10



Table continues on page E3.12

A. System Overview

B1. Cable Ties

B2. Cable Accessories

B3. Stainless Steel Ties

C1. Wiring Duct

C2. Surface Raceway

C3. Abrasion Protection

C4. Cable Management

D1. Terminals

D2. Power Connectors

D3. Grounding Connectors

E1. Labeling Systems

E2. Labels

E3. Pre-Printed & Write-On Markers

E4. Permanent Identification

E5. Lockout/Tagout & Safety Solutions

F. Index

Pre-Printed Clip-On Wire Markers (continued)

A.	System Overview
B1.	Cable Ties
B2.	Cable Accessories
B3.	Stainless Steel Ties
C1.	Wiring Duct
C2.	Surface Raceway
C3.	Abrasion Protection
C4.	Cable Management
D1.	Terminals
D2.	Power Connectors
D3.	Grounding Connectors
E1.	Labeling Systems
E2.	Labels
E3.	Pre-Printed & Write-On Markers
E4.	Permanent Identification
E5.	Lockout/Tagout & Safety Solutions
F.	Index

Part Number	Legend	No. of Markers Per Wand	Markers Per Pkg.	Std. Pkg. Qty.	Std. Ctn. Qty.		
Wire/Cable Diameter .11" – .13" (2.80mm – 3.30mm)							
PCA11-A thru PCA11-Z	A thru Z	30	300	1	10		
PCA11-A-J	A-J			1	10		
PCA11-K-T	K-T			1	10		
PCA11-U-Z	U-Z			1	10		
PCA11-0 thru PCA11-9	0 thru 9			1	10		
PCA11-0-9	0-9			1	10		
PCA11-MIN	—			1	10		
PCA11-PLS	+			1	10		
Wire/Cable Diameter .13" – .15" (3.30mm – 3.80mm)							
PCA13-A thru PCA13-Z	A thru Z			30	300	1	10
PCA13-A-J	A-J	1	10				
PCA13-K-T	K-T	1	10				
PCA13-U-Z	U-Z	1	10				
PCA13-0 thru PCA13-9	0 thru 9	1	10				
PCA13-0-9	0-9	1	10				
PCA13-MIN	—	1	10				
PCA13-PLS	+	1	10				
Wire/Cable Diameter .19" – .23" (4.80mm – 5.80mm)							
PCA18-A thru PCA18-Z	A thru Z	30	300			1	10
PCA18-A-J	A-J			1	10		
PCA18-K-T	K-T			1	10		
PCA18-U-Z	U-Z			1	10		
PCA18-0 thru PCA18-9	0 thru 9			1	10		
PCA18-0-9	0-9			1	10		
PCA18-MIN	—			1	10		
PCA18-PLS	+			1	10		
Wire/Cable Diameter .23" – .37" (5.80mm – 9.40mm)							
PCA23-A thru PCA23-Z	A thru Z			20	60	1	10
PCA23-A-D	A-D	1	10				
PCA23-E-H	E-H	1	10				
PCA23-I-L	I-L	1	10				
PCA23-M-P	M-P	1	10				
PCA23-Q-T	Q-T	1	10				
PCA23-U-X	U-X	1	10				
PCA23-Y-Z	Y-Z, +, -	1	10				
PCA23-0 thru PCA23-9	0 thru 9	60	1		10		
PCA23-0-3	0-3	80	1		10		
PCA23-4-7	4-7		1	10			
PCA23-8-9	8, 9, +, -		1	10			
PCA23-MIN	—	60	1	10			
PCA23-PLS	+		1	10			

PERMANENT IDENTIFICATION

PANDUIT offers the widest range of permanent identification solutions in the industry to withstand the test of time and provide legibility in harsh environments. Safe, quick, and easy to install, PANDUIT permanent identification solutions include stainless steel and aluminum marker plates, tags, marking tools and ties to deliver improved productivity and workplace safety.

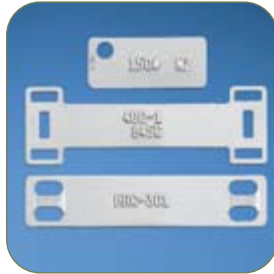

- Factory Custom Marking Service creates embossed or laser etched metal plates, tags, and ties to speed installation time and reduce labor costs
- Portable on-site marking tools for quick and easy identification on demand
- Large identification selection delivers maximum design flexibility to match your specific application requirements
- Optimized for easy use with PANDUIT self-locking stainless steel and aluminum ties; for details, refer to PAN-STEEL® System Section B3

PANDUIT continues to design permanent identification products for harsh environments by addressing customer problems with innovative solutions and reliable tooling to achieve lowest installed cost.

A.
System
Overview

B1.
Cable
Ties

B2.
Cable
Accessories

B3.
Stainless
Steel
Ties

C1.
Wiring
Duct

C2.
Surface
Raceway

C3.
Abrasion
Protection

C4.
Cable
Management

D1.
Terminals

D2.
Power
Connectors

D3.
Grounding
Connectors

E1.
Labeling
Systems

E2.
Labels

E3.
Pre-Printed
& Write-On
Markers

E4.
Permanent
Identification

E5.
Lockout/
Tagout/
& Safety
Solutions

F.
Index

A. System Overview

PANDUIT Factory Custom Marking Service

B1. Cable Ties

PANDUIT Factory Custom Marking Service simplifies identification with high quality, made-to-order custom embossed marker plates and tags or laser etched cable ties, marker plates, and tags. PANDUIT offers rapid direct shipment with fast turn around on custom marking orders worldwide. Work with PANDUIT to create an effectively identified workplace.

B2. Cable Accessories

B3. Stainless Steel Ties

EMBOSSING SERVICE

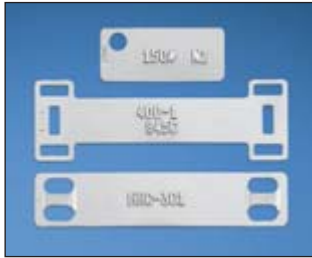

- Used on rectangular metal marker plates and tags which are a maximum of .020 inches (.5mm) thick and minimum .38 inches (10mm) width
- Excellent for applications that are exposed to dirt and paint
- Upper case "raised" character
- Alphanumeric and sequential numbering

C1. Wiring Duct

C2. Surface Raceway

C3. Abrasion Protection

C4. Cable Management

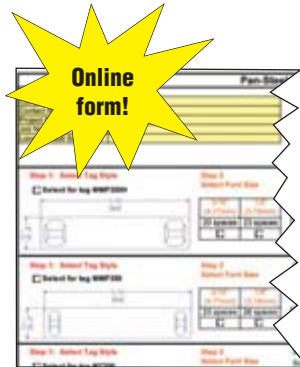

To select and order custom embossed marker plates and tags:

- Use online order form (C2-0677) at www.panduit.com/permanentID to select the proper marker plate or tag for your application. Email order form to your Authorized PANDUIT Distributor for order placement or contact PANDUIT Customer Service for assistance.

D1. Terminals

D2. Power Connectors

D3. Grounding Connectors

E1. Labeling Systems

E2. Labels

E3. Pre-Printed & Write-On Markers

E4. Permanent Identification

E5. Lockout/Tagout & Safety Solutions

F. Index

LASER MARKING SERVICE



- Used on all metal marker plates, tags, and cable ties
- BOLD block letters
- Upper and lower case character capability
- Ability to create text and graphics
- Alphanumeric and sequential numbering



To order laser etched plates and tags – Contact PANDUIT

Character sizes available:

- 1/8" (3.18mm)
- 3/16" (4.77mm)
- 1/4" (6.35mm)
- 5/16" (7.94mm)
- 1/2" (12.7mm) – Laser only



PANDUIT offers a full line of labeling products, software and printers to assist you with your labeling requirements.

See pages E1.0 – E2.30.



PANDUIT permanent identification products are optimized for easy use with PANDUIT self-locking stainless steel and aluminum ties. For details, refer to PAN-STEEL® System Section B3.

Stainless Steel and Brass Marker Plates and Tags

- Provides permanent identification of pipes, conduit, valves, cables and equipment in harsh environments
- Designed for use with *PANDUIT® PAN-STEEL®* Stainless Steel Cable Ties for fast installation at lowest installed cost
- All marker plates/tags can be embossed or laser etched with *PANDUIT* Factory Custom Marking Service
- For on-site custom marking use the *PANDUIT* Metal Indenting Machine (MIM) for details, see page E4.6
- Designated plates feature easy feed design with a raised slot to simplify cable tie installation and improve productivity



MMP350-C



MMP350H-C



MMP350DB-C



MMP350W38-C



MMP172-C



MMP172W38-C



MMP350W17-Q



MMP338W21-Q

Part Number	Material	Color	Length/ Diameter		Width		Custom Marking Parameters*		Used with <i>PAN-STEEL®</i> Cable Ties**	Thickness		Std. Pkg. Qty.	Std. Ctn. Qty.
			In.	mm	In.	mm	Max. 3/16" (4.77mm) Character Per Line	Max. Lines of Text		In.	mm		
MMP350-C‡	304 Stainless Steel	Natural	3.50	89	.75	19	23	3	MLT-S	.010	.25	100	1000
MMP350-C316‡	316 Stainless Steel	Natural	3.50	89	.75	19	23	3	MLT-S	.010	.25	100	1000
MMP350H-C‡	304 Stainless Steel	Natural	3.50	89	.75	19	20	3	MLT-H	.010	.25	100	1000
MMP350H-C316‡	316 Stainless Steel	Natural	3.50	89	.75	19	20	3	MLT-H	.010	.25	100	1000
MMP350DB-C‡	304 Stainless Steel	Natural	3.50	89	1.12	29	20	3	MLT-H	.015	.38	100	1000
MMP350DB-C316‡	316 Stainless Steel	Natural	3.50	89	1.12	29	20	3	MLT-H	.015	.38	100	1000
MMP350W38-C‡	304 Stainless Steel	Natural	3.50	89	.38	10	23	1	MLT-S	.010	.25	100	1000
MMP350W38-C316‡	316 Stainless Steel	Natural	3.50	89	.38	10	23	1	MLT-S	.010	.25	100	1000
MMP172-C‡	304 Stainless Steel	Natural	1.72	44	.75	19	8	3	MLT-S	.010	.25	100	1000
MMP172-C316‡	316 Stainless Steel	Natural	1.72	44	.75	19	8	3	MLT-S	.010	.25	100	1000
MMP172W38-C‡	304 Stainless Steel	Natural	1.72	44	.38	10	8	1	MLT-S	.010	.25	100	1000
MMP172W38-C316‡	316 Stainless Steel	Natural	1.72	44	.38	10	8	1	MLT-S	.010	.25	100	1000
MMP350W17-Q	304 Stainless Steel	Natural	3.50	89	1.73	44	26	6	MLT-S	.015	.38	25	250
MMP338W21-Q	304 Stainless Steel	Natural	3.38	86	2.13	54	22	6	MLT-S	.015	.38	25	250

*See page E4.2 for *PANDUIT* Factory Custom Marking Service information.

**See pages B3.5 – B3.7 for *PAN-STEEL®* Stainless Steel Cable Ties.

‡Easy feed marker plate with raised cable tie slot.

Table continues on page E4.4

A.
System
Overview

B1.
Cable Ties

B2.
Cable
Accessories

B3.
Stainless
Steel Ties

C1.
Wiring
Duct

C2.
Surface
Raceway

C3.
Abrasion
Protection

C4.
Cable
Management

D1.
Terminals

D2.
Power
Connectors

D3.
Grounding
Connectors

E1.
Labeling
Systems

E2.
Labels

E3.
Pre-Printed
& Write-On
Markers

E4.
Permanent
Identification

E5.
Lockout/
Tagout
& Safety
Solutions

F.
Index

A. System Overview

Stainless Steel and Brass Marker Plates and Tags (continued)

B1. Cable Ties



MT350-C



MT350W17-Q



MT338W21-Q



MT172-C

B2. Cable Accessories

B3. Stainless Steel Ties



MT172W38-C



MTB1D-Q



MTB150D-Q



MTB213D-Q



MT125S-Q

C1. Wiring Duct

C2. Surface Raceway

C3. Abrasion Protection

C4. Cable Management

D1. Terminals

D2. Power Connectors

D3. Grounding Connectors

E1. Labeling Systems

E2. Labels

E3. Pre-Printed & Write-On Markers

E4. Permanent Identification

E5. Lockout/Tagout & Safety Solutions

F. Index

Part Number	Material	Color	Length/ Diameter		Width		Custom Marking Parameters*		Used with PAN-STEEL® Cable Ties**	Thickness		Std. Pkg. Qty.	Std. Ctn. Qty.
			In.	mm	In.	mm	Max. 3/16" (4.77mm) Character Per Line	Max. Lines of Text		In.	mm		
MT350-C	304 Stainless Steel	Natural	3.50	89	.75	19	26	3	MLT-S	.010	.25	100	1000
MT350-C316	316 Stainless Steel	Natural	3.50	89	.75	19	23	3	MLT-S	.010	.25	100	1000
MT350W17-Q	304 Stainless Steel	Natural	3.50	89	1.73	44	23	6	MLT-S	.015	.38	25	250
MT338W21-Q	304 Stainless Steel	Natural	3.38	86	2.13	54	22	6	MLT-S	.015	.38	25	250
MT172-C	304 Stainless Steel	Natural	1.72	44	.75	19	10	3	MLT-S	.010	.25	100	1000
MT172-C316	316 Stainless Steel	Natural	1.72	44	.75	19	10	3	MLT-S	.010	.25	100	1000
MT172W38-C	304 Stainless Steel	Natural	1.72	44	.38	10	10	1	MLT-S	.010	.25	100	1000
MT1D-Q	304 Stainless Steel	Natural	—	—	1.00 circular	25	5	1	MLT-S	.035	.89	25	250
MT1D-Q316	316 Stainless Steel	Natural	—	—	1.00 circular	25	5	1	MLT-S	.035	.89	25	250
MTB1D-Q	Brass	Brass	—	—	1.00 circular	25	5	1	MLT-S	.040	1.02	25	250
MT150D-Q	304 Stainless Steel	Natural	—	—	1.50 circular	38	5,6,5	3	MLT-S	.035	.89	25	250
MT150D-Q316	316 Stainless Steel	Natural	—	—	1.50 circular	38	5,6,5	3	MLT-S	.035	.89	25	250
MTB150D-Q	Brass	Brass	—	—	1.50 circular	38	5,6,5	3	MLT-S	.040	1.02	25	250
MT213D-Q	304 Stainless Steel	Natural	—	—	2.13 circular	54	6,12,8	3	MLT-S	.015	.38	25	250
MT213D-Q316	316 Stainless Steel	Natural	—	—	2.13 circular	54	6,12,8	3	MLT-S	.015	.38	25	250
MTB213D-Q	Brass	Brass	—	—	2.13 circular	54	6,12,8	3	MLT-S	.015	.38	25	250
MT125S-Q	304 Stainless Steel	Natural	1.25 square	32	1.25 square	32	5	2	MLT-S	.035	.89	25	250

*See page E4.2 for PANDUIT Factory Custom Marking Service information.

**See pages B3.5 – B3.7 for PAN-STEEL® Stainless Steel Cable Ties.



PAN-ALUM™ Aluminum Marker Plates

- Lightweight, aluminum construction for flexibility and ease of handling
- Five color options in addition to natural aluminum provide quick visual identification, ideal for applications requiring color-coding

- Easy feed marker plate design includes a raised slot to simplify cable tie installation and improve productivity



Part Number	Material	Color	Length		Width		Custom Marking Parameters*		Used with PAN-ALUM™ Cable Ties	Std. Pkg. Qty.	Std. Ctn. Qty.
			In.	mm	In.	mm	Max. 3/16" (4.77mm) Characters per Line	Max. Lines			
MMP350H-CALBU	Anodized Aluminum	Blue	3.50	88.9	.75	19.1	20	3	MLT1H-LPAL* MLT2H-LPAL* and MLT4H-LPAL*	100	1000
MMP350H-CALGR		Green								100	1000
MMP350H-CALRD		Red								100	1000
MMP350H-CALBL		Black								100	1000
MMP350H-CALYL		Yellow								100	1000
MMP350H-CAL	Aluminum	Natural								100	1000

*See PAN-ALUM™ Aluminum Ties on page B3.10 for matching natural finish and five colors.

**See page E4.2 for PANDUIT Factory Custom Marking Service.

Metal Embossing Tool and Tape System

- Creates custom length identification
- Embosses 3/16" (4.77mm) characters onto stainless steel or aluminum tape

- Ability to create a raised cable tie slot for fast installation



Part Number	Part Description	Std. Pkg. Qty.
Tool Kit		
MEHT	Includes tool, carrying case, one roll each META (aluminum) and METS4 (stainless steel) tape. Characters include: A B C D E F G H I J K L M N O P Q R S T U V W X Y Z 2 3 4 5 6 7 8 9 . -	1
Tape		
META-X	.50" x 16' (12.7mm x 4.9m) aluminum tape*	10
METS3-X	.50" x 21' (12.7mm x 6.4m) 316 grade stainless steel tape.	10
METS4-X	.50" x 21' (12.7mm x 6.4m) 304 grade stainless steel tape.	10

*Aluminum ties are recommended for use with aluminum tape to prevent galvanic reaction (corrosion that can occur between stainless steel and aluminum in certain environments).

A. System Overview

B1. Cable Ties

B2. Cable Accessories

B3. Stainless Steel Ties

C1. Wiring Duct

C2. Surface Raceway

C3. Abrasion Protection

C4. Cable Management

D1. Terminals

D2. Power Connectors

D3. Grounding Connectors

E1. Labeling Systems

E2. Labels

E3. Pre-Printed & Write-On Markers

E4. Permanent Identification

E5. Lockout/Tagout & Safety Solutions

F. Index

A.
System
Overview



Metal Indenting Machine

B1.
Cable Ties

- Provides quick, easy, and permanent identification with **PANDUIT® PAN-ALUM™** Marker Plates and Cable Ties and **PAN-STEEL®** Stainless Steel Marker Plates, Tags, Cable Ties and Straps
- Automatic table indexing advances material forward for convenience and improved productivity
- New, improved design features aluminum base and durable construction

B2.
Cable
Accessories



B3.
Stainless
Steel Ties

C1.
Wiring
Duct



C2.
Surface
Raceway

C3.
Abrasion
Protection

C4.
Cable
Management

Marker Stamp Kit

- Provides permanent identification of **PANDUIT® PAN-STEEL®** Stainless Steel Cable Ties, Straps, Marker Plates and Tags

D2.
Power
Connectors



D3.
Grounding
Connectors

E1.
Labeling
Systems

E2.
Labels

E3.
Pre-Printed
& Write-On
Markers

E4.
Permanent
Identification

E5.
Lockout/
Tagout/
& Safety
Solutions

F.
Index

Part Number	Part Description	Std. Pkg. Qty.
Indenting Machine		
MIM094	Indenting machine with 3/32" (2.38mm) character wheel.	1
MIM125	Indenting machine with 1/8" (3.18mm) character wheel.	1
MIM187	Indenting machine with 3/16" (4.77mm) character wheel.	1
Interchangeable Wheel Kits		
MIW094	3/32" (2.38mm) character wheel kit (wheel and indexing gear).	1
MIW125	1/8" (3.18mm) character wheel kit (wheel and indexing gear).	1
MIW187	3/16" (4.77mm) character wheel kit (wheel and indexing gear).	1

Part Number	Part Description	Std. Pkg. Qty.
STK12	Marker stamp kit contains (100) character stamps, (1) holder and (1) carrying case. High quality 1/8" (3.18mm) nom. size steel character. Type holder keeps type aligned and provides uniform depth of impression. The holder takes up to nine characters – 1 1/8" (28.6mm) long.	1

Characters include:

A A A B B C C D D E E E E F F G G H H I I J J K K L L L M M N N N O O O P P Q R R R R S S S T T U U U V V W
W X X Y Z & // - - . . . , 1 1 1 1 2 2 2 2 3 3 3 3 4 4 4 4 5 5 5 5 6 6 6 6 7 7 7 7 8 8 8 8 9 9 0 0 0

LOCKOUT/TAGOUT

The Occupational Safety and Health Administration (OSHA) mandates that all energy sources be isolated and locked out to protect employees from injuries caused by the accidental startup of equipment under repair or service. OSHA 1910.147 outlines the control of this hazardous energy with an effective lockout/tagout program. *PANDUIT* offers a complete line of lockout/tagout products to aid in compliance with OSHA 1910.147 including:



- Training manuals and videos to help train employees on the requirements of lockout/tagout
- Extensive line of universal, high quality devices to lockout a variety of energy sources
- Lockout/tagout kits and stations that offer a convenient method to store and contain lockout devices, tags, and padlocks
- High quality, durable, secure padlocks in a variety of styles, colors, and keying configurations that ensure safety and security
- Extensive line of safety identification products that include tags, signs, and warning labels

PANDUIT offers everything you need to establish and maintain an effective lockout/tagout program. Ensure employee safety while conducting lockout/tagout procedures by utilizing *PANDUIT* innovative products and high quality materials.

A.
System
Overview

B1.
Cable Ties

B2.
Cable
Accessories

B3.
Stainless
Steel Ties

C1.
Wiring
Duct

C2.
Surface
Raceway

C3.
Abrasion
Protection

C4.
Cable
Management

D1.
Terminals

D2.
Power
Connectors

D3.
Grounding
Connectors

E1.
Labeling
Systems

E2.
Labels

E3.
Pre-Printed
& Write-On
Markers

E4.
Permanent
Identification

E5.
Lockout/
Tagout
& Safety
Solutions

F.
Index

A.
System
Overview

OSHA Lockout/Tagout Compliance Manual

B1.
Cable Ties

- Takes you step-by-step through the process of bringing your company into compliance with OSHA Standard 1910.147; topics in the manual include background, scope, and purpose of the regulation

- This complete package includes:
 - Instructions for writing a company lockout/tagout policy
 - Establishing lockout/tagout procedures for equipment
 - Implementing a lockout/tagout training program
 - Forms, sample programs, and procedures to administer your program

B2.
Cable
Accessories



B3.
Stainless
Steel Ties

Part Number	Part Description	Std. Pkg. Qty.
PSL-LCM	OSHA lockout/tagout compliance manual.	1

C1.
Wiring
Duct

C2.
Surface
Raceway

Lockout/Tagout Regulations Training Video and Handbooks

- “A Life is on the Line” Lockout/Tagout Training Program (English or Spanish) is designed to protect your employees and assist in compliance with OSHA lockout/tagout general requirements quickly, easily, and at low cost

- This complete package includes:
 - Lockout/tagout video
 - Participant guides with quizzes
 - Certificate of completion cards
 - Leader’s guide complete with quiz key
 - Training log
 - Lockout/tagout samples
 - *PANDUIT* lockout/tagout bulletin

C3.
Abrasion
Protection

C4.
Cable
Management



D1.
Terminals

D2.
Power
Connectors

D3.
Grounding
Connectors

Part Number	Part Description	Number of Guides and Cards Included	Std. Pkg. Qty.	Std. Ctn. Qty.
PSL-LTP	Lockout/tagout regulations video complete training program, English, VHS format.	10	1	—
PSL-LTM	Replacement lockout/tagout participant guides and cards, English.	10	1	10
PSL-LTPS	Lockout/tagout regulations video complete training program, Spanish, VHS format.	10	1	—
PSL-LTMS	Replacement lockout/tagout participant guides and cards, Spanish.	10	1	10
PSL-LTV	Lockout/tagout regulations training video, English, VHS format.	—	1	—
PSL-LTV-DVD	Lockout/tagout regulations training video, English, DVD format.	—	1	10

E1.
Labeling
Systems

Group Lockout/Tagout Training Video

E2.
Labels

- “Your Lock is Your Key to Life” Training Program provides thorough instruction on OSHA recommended safety practices and procedures for group lockout – multi-craft/multi-shift lockout operations

- This complete package includes:
 - Group lockout/tagout video
 - Participant guides with quizzes
 - Certificate of completion cards
 - Leader’s guide complete with quiz key
 - Training log
 - Lockout/tagout samples
 - *PANDUIT* lockout/tagout bulletin
 - Lockout steps wallet cards

E3.
Pre-Printed
& Write-On
Markers

E4.
Permanent
Identification



E5.
Lockout/
Tagout
& Safety
Solutions

F.
Index

Part Number	Part Description	Number of Guides and Cards Included	Std. Pkg. Qty.	Std. Ctn. Qty.
PSL-LTPGP	Group lockout/tagout video complete training program, English, VHS format.	10	1	5
PSL-LTMGP	Replacement group lockout/tagout participant guides and cards, English.	10	1	10

Lockout/Tagout Steps/Calendar Wallet Card

- Provides those employees responsible for lockout/tagout with a constant reminder of the OSHA recommended steps for shutdown and startup
- Current calendar year is printed on back side



Part Number	Part Description	Width		Height		Number of Cards Included	Std. Pkg. Qty.	Std. Ctn. Qty.
		In.	mm	In.	mm			
PSL-STEPS	Lockout/tagout steps/calendar wallet card.	2.13	54.00	3.38	86.00	25	1	4

Circuit Breaker Lockout Devices

- Individual circuit breakers can be locked in the off position quickly and easily
- Compact, universal design fits a wide range of single, double, and triple handle circuit breakers
- Accommodates breaker handles .30 – .60 inches (7.62mm – 15.24mm) tall and .25 – .44 inches (6.35mm – 11.18mm) thick
- Easily attached with no modifications to panel or circuit breaker and does not require hole in circuit breaker handle
- Constructed of rugged nylon and stainless steel, providing strength, durability, added security and corrosion resistance



Part Number	Part Description	Std. Pkg. Qty.	Std. Ctn. Qty.
PSL-CB	Universal circuit breaker lockout.	1	10
PSL-CBIL	Circuit breaker lockout device for use with Square D I-LINE^/Federal Pacific (FPE) circuit breakers.	1	10

^I-LINE is a registered trademark of Square D Company.

“No Tool” Circuit Breaker Lockout Devices

- Individual circuit breaker can be locked in the off position quickly and easily without any tools
- Compact, universal design fits a wide range of single, double, and triple handle circuit breakers
- Accommodates breaker handle sizes ranging from .30 – .60 inches (7.62mm – 15.24mm) tall and .16 – .35 inches (4.06mm x 8.89mm) thick
- Easily attached with no modifications to panel or circuit breaker and does not require holes in circuit breaker handle
- Constructed of rugged nylon and stainless steel providing strength, durability, added security and corrosion resistance



Part Number	Part Description	Std. Pkg. Qty.	Std. Ctn. Qty.
PSL-CBNT	“No Tool” universal circuit breaker lockout.	1	10
PSL-CBILNT	“No Tool” circuit breaker lockout for use with Square D I-LINE^/Federal Pacific (FPE) circuit breakers.	1	10

^I-LINE is a registered trademark of Square D Company.

A. System Overview

B1. Cable Ties

B2. Cable Accessories

B3. Stainless Steel Ties

C1. Wiring Duct

C2. Surface Raceway

C3. Abrasion Protection

C4. Cable Management

D1. Terminals

D2. Power Connectors

D3. Grounding Connectors

E1. Labeling Systems

E2. Labels

E3. Pre-Printed & Write-On Markers

E4. Permanent Identification

E5. Lockout/Tagout & Safety Solutions

F. Index

A.
System
Overview

Large Handle Circuit Breaker Lockout Device

B1.
Cable Ties

- Individual circuit breakers can be locked in the off position quickly and easily without any tools
- Easily attached with no modifications to panel or circuit breaker
- Compact, universal design fits a wide range of large handle circuit breakers
- Constructed of rugged nylon and stainless steel providing strength, durability, added security and corrosion resistance

B2.
Cable
Accessories

- Accommodates breaker handle dimensions up to .80 inches thick x 3.00 inches wide (20.32mm x 76.20mm)



Part Number	Part Description	Std. Pkg. Qty.	Std. Ctn. Qty.
PSL-CBL	Large handle circuit breaker lockout.	1	10

C1.
Wiring
Duct

C2.
Surface
Raceway

C3.
Abrasion
Protection

Plug Lockout Device

C4.
Cable
Management

- Individual plugs in a wide range of sizes can be locked out to prevent energization
- Constructed of rugged polycarbonate providing strength, durability, added security and corrosion resistance
- Accommodates padlocks with shackle lengths of 1.50 inches (38.10mm) or greater and plugs with a hole in a blade

D1.
Terminals



Part Number	Part Description	Std. Pkg. Qty.	Std. Ctn. Qty.
PSL-P	Plug lockout.	1	10

D2.
Power
Connectors

D3.
Grounding
Connectors

E1.
Labeling
Systems

E2.
Labels

Cord Lockout Devices

E3.
Pre-Printed
& Write-On
Markers

- Individual corded plugs in a wide range of sizes can be locked out to prevent energization
- Constructed of rugged polypropylene providing strength, durability, and added security

E4.
Permanent
Identification



Part Number	Part Description	Std. Pkg. Qty.	Std. Ctn. Qty.
PSL-CL110	Lockout for 120 VAC corded plugs, 2.00" x 2.00" x 3.50" inside dimensions.	1	10
PSL-CL480	Lockout for 240 – 480 VAC corded plugs, 3.25" x 3.25" x 6.50" inside dimensions.	1	10

E5.
Lockout/
Tagout/
& Safety
Solutions

F.
Index

Receptacle Blockout Device

- Accommodates standard 120 V electrical receptacles
- Blockout receptacles to prevent equipment damage from overloading circuits or electrical interference

- Constructed of high density polyethylene providing strength, durability, and added security



Part Number	Part Description	Std. Pkg. Qty.	Std. Ctn. Qty.
PSL-ERB	Blockout for 120 V electrical receptacle.	1	25

Toggle Switch Lockout Device

- Compact secure design fits most toggle switches and some small circuit breakers
- Easily attached without removal of faceplate or screws

- Accommodates switches .45 – .78 inches (11.43mm – 19.81mm) tall x .25 – .38 inches (6.35mm – 9.65mm) wide x .25 – .40 inches (6.35mm – 10.16mm) thick
- Constructed of rugged nylon and stainless steel providing strength, durability, added security and corrosion resistance



Part Number	Part Description	Std. Pkg. Qty.	Std. Ctn. Qty.
PSL-WS	Toggle switch lockout.	1	10

Toggle/Rocker Switch Lockout Device

- Toggle/rocker switches controlling electrical supply can be locked out
- Accommodates standard wall switch faceplates
- Install using faceplate screws

- Constructed of rugged polypropylene providing strength, durability, and added security



Part Number	Part Description	Std. Pkg. Qty.	Std. Ctn. Qty.
PSL-WS1A	Toggle/rocker switch lockout.	1	10

Gate Valve Lockout Devices

- Gate valves regulating hydraulic, pneumatic, and chemical energy can be locked out quickly and easily
- Accommodates valve handles ranging from 1.00 inch (25.40mm) to 13.00 inches (330.20mm) in diameter

- Constructed of rugged polypropylene providing strength, durability, and added security



Part Number	Part Description	Std. Pkg. Qty.	Std. Ctn. Qty.
PSL-V2A	Gate valve lockout, accommodates 1.00" – 2.50" diameter handle.	1	10
PSL-V6A	Gate valve lockout, accommodates 2.50" – 6.50" diameter handle.	1	10
PSL-V9	Gate valve lockout, accommodates 6.50" – 10.00" diameter handle.	1	10
PSL-V13	Gate valve lockout, accommodates 10.00" – 13.00" diameter handle.	1	—

A.
System
Overview

B1.
Cable
Ties

B2.
Cable
Accessories

B3.
Stainless
Steel Ties

C1.
Wiring
Duct

C2.
Surface
Raceway

C3.
Abrasion
Protection

C4.
Cable
Management

D1.
Terminals

D2.
Power
Connectors

D3.
Grounding
Connectors

E1.
Labeling
Systems

E2.
Labels

E3.
Pre-Printed
& Write-On
Markers

E4.
Permanent
Identification

E5.
Lockout/
Tagout
& Safety
Solutions

F.
Index

A. System Overview

Ball Valve Lockout Devices

B1. Cable Ties

- Ball valves regulating hydraulic, pneumatic, and chemical energy can be locked out quickly and easily
- Accommodates valve diameters ranging from .25 inches (6.35mm) to 3.00 inches (76.20mm)
- Constructed of rugged polypropylene providing strength, durability, and added security

B2. Cable Accessories



B3. Stainless Steel Ties

Part Number	Part Description	Std. Pkg. Qty.	Std. Ctn. Qty.
PSL-BV1	Ball valve lockout, accommodates .25" – 1.00" valve diameter.	1	10
PSL-BV2	Ball valve lockout, accommodates 1.25" – 3.00" valve diameter.	1	10

C1. Wiring Duct

C2. Surface Raceway

Multiple Lockout Device

- Device can be used alone as a lockout hasp or with provided 0.19 inches (4.8mm) diameter cable to lockout electrical disconnects, gate valves, or large cumbersome devices
- Compact and easy to install
- Constructed of rugged polycarbonate and stainless steel providing strength, durability, added security and corrosion resistance

C3. Abrasion Protection



C4. Cable Management

Part Number	Part Description	Std. Pkg. Qty.	Std. Ctn. Qty.
PSL-MLD	Multiple lockout device; includes lockout hasp and 6.0' (1.8m) vinyl coated galvanized steel cable with loophole.	1	20
PSL-MLDH-X	Multiple lockout device (hasp only).	10	—
PSL-MLDC	6.0' (1.8m) vinyl coated galvanized steel cable with loophole (cable only).	1	5
PSL-MLDC200	200.0' (61.0m) vinyl coated galvanized steel cable on roll without loophole (cable only).	1	—

D1. Terminals

D2. Power Connectors

D3. Grounding Connectors



Lockout single or multiple electrical disconnects



Lockout gate valves



Immobilize large or cumbersome devices, such as forklifts

E1. Labeling Systems

E2. Labels

Pneumatic Energy Lockout Device

E3. Pre-Printed & Write-On Markers

- Pneumatic energy devices can be locked out quickly and easily without costly tool modifications or inconvenient in-line valves
- When installed on the male pneumatic fitting, prevents the ability to engage into the female fitting
- Universal compact design makes the pneumatic lockout device easy to transport and install on almost any fitting, even in tight spaces
- Rugged stainless steel construction offers superior strength, durability, added security and corrosion resistance

E4. Permanent Identification



E5. Lockout/Tagout & Safety Solutions

Part Number	Part Description	Std. Pkg. Qty.	Std. Ctn. Qty.
PSL-PEL	Pneumatic energy lockout device, 3.50" (88.9mm) diameter x 0.10" (2.54mm) thick.	1	20

F. Index



Jack Module Blockout Device

- Blocks unauthorized access to jacks and potentially harmful foreign objects, saving time and money associated with data security breaches, network downtime, repair and hardware replacement
- Compatible with most RJ45 jacks to accommodate a variety of applications and does not interfere with jack contacts

- Can be installed/removed without interfering with adjacent jacks or hardware
- May only be released with the special removal tool, ensuring the safety and security of your network infrastructure



Part Number	Part Description	Color	Std. Pkg. Qty.	Std. Ctn. Qty.
PSL-DCJB*	Package of ten jack module blockout devices and one removal tool.	Red	1	20
PSL-DCJB-BL*	Package of ten jack module blockout devices and one removal tool.	Black	1	20
PSL-DCJB-BU*	Package of ten jack module blockout devices and one removal tool.	Blue	1	20
PSL-DCJB-YL*	Package of ten jack module blockout devices and one removal tool.	Yellow	1	20
PSL-DCJB-IW*	Package of ten jack module blockout devices and one removal tool.	International White	1	20
PSL-DCJB-GR*	Package of ten jack module blockout devices and one removal tool.	Green	1	20

*Available in bulk packages of 100 devices and five removal tools. To order bulk package add -C to the suffix of part number.

RJ45 Plug Lockin Device



- Tamper-resistant design blocks unauthorized removal of cable, IP phone, other networking equipment or critical connection

- Deters unauthorized users from moving or stealing VoIP phones helping to maintain E911 service
- Compact design does not interfere with adjacent jacks, even in high-density applications



Part Number	Part Description	Color	Std. Pkg. Qty.	Std. Ctn. Qty.
PSL-DCPL*	Package of ten RJ45 plug lockin devices and one installation/removal tool.	Red	1	20
PSL-DCPL-BL*	Package of ten RJ45 plug lockin devices and one installation/removal tool.	Black	1	20
PSL-DCPL-BU*	Package of ten RJ45 plug lockin devices and one installation/removal tool.	Blue	1	20
PSL-DCPL-YL*	Package of ten RJ45 plug lockin devices and one installation/removal tool.	Yellow	1	20
PSL-DCPL-IW*	Package of ten RJ45 plug lockin devices and one installation/removal tool.	International White	1	20
PSL-DCPL-GR*	Package of ten RJ45 plug lockin devices and one installation/removal tool.	Green	1	20
PSL-DCPLR*	Package of ten recessed RJ45 plug lockin devices and one installation/removal tool.	Red	1	20
PSL-DCPLR-BL*	Package of ten recessed RJ45 plug lockin devices and one installation/removal tool.	Black	1	20
PSL-DCPLR-BU*	Package of ten recessed RJ45 plug lockin devices and one installation/removal tool.	Blue	1	20
PSL-DCPLR-YL*	Package of ten recessed RJ45 plug lockin devices and one installation/removal tool.	Yellow	1	20
PSL-DCPLR-IW*	Package of ten recessed RJ45 plug lockin devices and one installation/removal tool.	International White	1	20
PSL-DCPLR-GR*	Package of ten recessed RJ45 plug lockin devices and one installation/removal tool.	Green	1	20

*Available in bulk packages of 100 devices and five removal tools. To order bulk package add -C to the suffix of part number.

A. System Overview

B1. Cable Ties

B2. Cable Accessories

B3. Stainless Steel Ties

C1. Wiring Duct

C2. Surface Raceway

C3. Abrasion Protection

C4. Cable Management

D1. Terminals

D2. Power Connectors

D3. Grounding Connectors

E1. Labeling Systems

E2. Labels

E3. Pre-Printed & Write-On Markers

E4. Permanent Identification

E5. Lockout/Tagout & Safety Solutions

F. Index

A.
System
Overview

Electrician Lockout Kit

- Kit contains a variety of lockout/tagout devices commonly used by an individual electrician

B1.
Cable Ties



B2.
Cable
Accessories

B3.
Stainless
Steel Ties

Part Number	Contents	Std. Pkg. Qty.	Std. Ctn. Qty.
PSL-PK-EA	(1) Screwdriver. (1) PSL-PK pouch. (1) PSL-3RED-LS long shackle padlock with red label. (1) PSL-MLD multiple lockout device. (1) PSL-WS wall switch lockout device. (1) PSL-CBNT "No Tool" universal circuit breaker lockout device. (1) PSL-P plug lockout device. (5) PVT-30 Electrician's blocking tags.	1	5

C1.
Wiring
Duct

Contractor Lockout Kit

- Kit contains a variety of lockout/tagout devices commonly used by electrical contractors

C2.
Surface
Raceway



C3.
Abrasion
Protection

C4.
Cable
Management

Part Number	Contents	Std. Pkg. Qty.
PSL-KT-CONA	(1) Screwdriver. (1) PSL-KT carrying case – 5.0" x 3.5" x 11.0" (127mm x 89mm x 279mm). (3) PSL-3RED-LS long shackle padlocks with red labels. (3) PSL-3RED standard shackle padlocks with red labels. (1) PSL-1A lockout hasp – 1.0" (25mm) jaw diameter. (1) PSL-MLD multiple lockout device. (3) PSL-WS wall switch lockouts. (3) PSL-CBNT circuit breaker lockouts. (3) PSL-P plug lockouts. (15 Tags) PVT-98 "EQUIPMENT LOCKED OUT BY..." safety tags.	1

D1.
Terminals

MRO Lockout Kit

- Kit contains a variety of lockout/tagout devices commonly used by maintenance and repair personnel

D2.
Power
Connectors



D3.
Grounding
Connectors

E1.
Labeling
Systems

E2.
Labels

Power and Panel Distribution Lockout Kit

- Kit contains a variety of lockout/tagout devices commonly used to isolate electrical distribution panels
- Durable steel case can be wall mounted or used as a portable case

E3.
Pre-Printed
& Write-On
Markers



E4.
Permanent
Identification

E5.
Lockout/
Tagout/
& Safety
Solutions

F.
Index

Part Number	Contents	Std. Pkg. Qty.
PSL-KT-MROA	(1) Screwdriver. (1) PSL-BX carrying case – 6.5" x 5.0" x 14.5" (32mm x 127mm x 368mm). (3) PSL-3RED-LS long shackle padlocks with red labels. (1) PSL-MLD multiple lockout device. (2) PSL-WS wall switch lockouts. (2) PSL-CBNT circuit breaker lockouts. (2) PSL-P plug lockouts. (1) PSL-V6A gate valve lockout – 6.5" (165mm). (1) PSL-V2A gate valve lockout – 2.5" (64mm). (1) PSL-BV2 ball valve lockout – 3.0" (76mm). (1) PSL-CL110 110V plug lockout. (10) PVT-44 "DO NOT OPERATE" maintenance tags.	1

Part Number	Contents	Std. Pkg. Qty.
PSL-KT-PWR	(1) Screwdriver. (1) PSL-STATION metal wall mount cabinet. (2) PSL-3-RED-LS long shackle padlocks with red labels. (1) PSL-MLD multiple lockout device. (2) PSL-CBNT universal circuit breaker lockout device. (2) PSL-CBILNT circuit breaker lockout device for Square D I-LINE^/Federal Pacific (FPE) circuit breakers. (2) PSL-CBL large handle circuit breaker lockout devices. (1) PSL-P plug lockout. (25) PVT-23-Q "DO NOT OPERATE ELECTRICIANS AT WORK" tags.	1

Order number required.

^I-LINE is a registered trademark of Square D Company.

Metal Wall Mount Cabinet

- Conveniently store lockout tools and accessories in one common area



- Durable steel case can be wall-mounted (nine mounting holes) or used as a portable case
- 14.75" x 10.25" x 4.63" (375.00mm x 260.00mm x 117.00mm)

Part Number	Part Description	Std. Pkg. Qty.
PSL-STATION	Metal wall mount cabinet.	1

Lockout Stations

- Conveniently store padlocks, tags, and lockout devices in one common area



Part Number	Part Description	Width		Height		Std. Pkg. Qty.
		In.	mm	In.	mm	
PSL-20S	Lockout station only, twenty person.	24.00	610.00	19.00	483.00	1
PSL-20SWC	Lockout station with components, twenty persons. Components include: (20) PSL-3RED padlocks (keyed differently) (6) PSL-1.5 lockout hasps (25 tags) PVT-98 safety tags (25 tags) PVT-41 safety tags	24.00	610.00	19.00	483.00	1
PSL-10S	Lockout station only, ten person.	12.00	305.00	19.00	483.00	1
PSL-10SWC	Lockout station with components, ten person. Components include: (10) PSL-3RED padlocks (keyed differently) (3) PSL-1.5 lockout hasps (15 tags) PVT-98 safety tags (10 tags) PVT-41 safety tags	12.00	305.00	19.00	483.00	1
PSL-4S	Lockout station only, four person.	12.00	305.00	9.50	241.00	1
PSL-4SWC	Lockout station with components, four person. Components include: (4) PSL-3RED padlocks (keyed differently) (3) PSL-1.5 lockout hasps (15 tags) PVT-98 safety tags	12.00	305.00	9.50	241.00	1

Group Lock Box

- Manage multiple employees and energy sources involved in a group lockout procedure
- Accommodates up to thirteen padlocks (not included)



- Industrial powder coated steel construction
- Dimensions: 9.00"W x 6"H x 3.25"D (228.60mm x 152.40mm x 82.55mm)

Part Number	Part Description	Std. Pkg. Qty.
PSL-GLB	Group lock box.	1

A. System Overview

B1. Cable Ties

B2. Cable Accessories

B3. Stainless Steel Ties

C1. Wiring Duct

C2. Surface Raceway

C3. Abrasion Protection

C4. Cable Management

D1. Terminals

D2. Power Connectors

D3. Grounding Connectors

E1. Labeling Systems

E2. Labels

E3. Pre-Printed & Write-On Markers

E4. Permanent Identification

E5. Lockout/Tagout & Safety Solutions

F. Index

A.
System
Overview

Warning Label

B1.
Cable Ties

- Warning label prohibits tampering with push buttons during repair or service
- Made of vinyl cloth material that allows label to be removed easily after repairs are completed
- Write-on area for adding your own warning message
- Features the international prohibition symbol for “Do Not Throw Switch”

B2.
Cable
Accessories



B3.
Stainless
Steel Ties

Material Chart

Material	Print Method	Temperature Range	Features
Vinyl Cloth, White	Pre-Printed	-50°F to 170°F (-46°C to 77°C)	Indoor/outdoor rated; thin conformable material with repositionable adhesive allows label to be removed and reused or used in temporary applications; provides durability, high temperature resistance, and dimensional stability for rough or textured surfaces.

C1.
Wiring
Duct

C2.
Surface
Raceway

Part Number	Part Description	Width		Height		Markers Per Book	Std. Pkg. Qty. (Book)	Std. Ctn. Qty. (Books)
		In.	mm	In.	mm			
PSL-CBWL	Warning label	4.84	123.00	.54	14.00	60	1	10

C3.
Abrasion
Protection

Can be clearly identified with *PANDUIT* permanent marking pens, page E5.20.

C4.
Cable
Management

D1.
Terminals

Circuit Breaker Directory Sign

D2.
Power
Connectors

- Adhesive paper sign designed to provide clear identification of circuit breaker connections, list up to 40 circuits
- Eliminate the guesswork when identifying power sources – a must for lockout/tagout compliance

D3.
Grounding
Connectors



Material Chart

Material	Print Method	Temperature Range	Features
Paper	Pre-Printed	-65°F to 200°F (-54°C to 93°C)	Indoor rated; general purpose material; excellent adhesion properties when applied to a clean, dry surface.

E1.
Labeling
Systems

E2.
Labels

Part Number	Part Description	Color (Legend/Background)	Labels Per Pkg.	Width		Height		Std. Pkg. Qty.	Std. Ctn. Qty.
				In.	mm	In.	mm		
PES-S1	Circuit breaker directory sign.	Red and Black/White	5	13.00	330.00	5.50	140.00	1	20

E3.
Pre-Printed
& Write-On
Markers

E4.
Permanent
Identification

E5.
Lockout/
Tagout/
& Safety
Solutions

F.
Index

Safety Lockout Padlocks

- Rugged, lightweight XENYO‡ plastic body with steel shackle
- Each lock keyed differently and supplied with one key and padlock labels in English, Spanish, and French
- .25 inches (6.00mm) diameter shackle



Part Number	Color	Std. Pkg. Qty.
1.50" (38.10mm) Short Body		
PSL-4BLK	Black	6
PSL-4BLU	Blue	6
PSL-4GRN	Green	6
PSL-4ORG	Orange	6
PSL-4PRP	Purple	6
PSL-4RED	Red	6
PSL-4TEL	Teal	6
PSL-4YEL	Yellow	6
3.00" (76.20mm) Long Body		
PSL-4BLK-LB	Black	6
PSL-4BLU-LB	Blue	6
PSL-4GRN-LB	Green	6
PSL-4ORG-LB	Orange	6
PSL-4PRP-LB	Purple	6
PSL-4RED-LB	Red	6
PSL-4TEL-LB	Teal	6
PSL-4YEL-LB	Yellow	6

These locks can be master keyed or keyed alike. These locks can also be custom engraved.
 ‡XENYO is a registered trademark of General Electric Company.
 See Custom Lock Options on page E5.20.

High Security Padlocks

- Aluminum padlock with hardened steel shackles
- Powder coated finish resists scratches
- Ideal for corrosive and tough environments
- 30% lighter than laminated steel
- Each lock keyed differently and supplied with two keys
- .25 inches (6.00mm) diameter shackle



Part Number	Color	Std. Pkg. Qty.
1.00" (25.40mm) Shackle		
PSL-11BLK	Black	6
PSL-11BLU	Blue	6
PSL-11GRN	Green	6
PSL-11ORNG	Orange	6
PSL-11RED	Red	6
PSL-11YEL	Yellow	6
3.00" (76.20mm) Shackle		
PSL-11BLK-LS	Black	6
PSL-11BLU-LS	Blue	6
PSL-11GRN-LS	Green	6
PSL-11ORNG-LS	Orange	6
PSL-11RED-LS	Red	6
PSL-11YEL-LS	Yellow	6

These locks can be master keyed or keyed alike and custom engraved.
 See Custom Lock Options on page E5.13.

A.
System
Overview

B1.
Cable Ties

B2.
Cable
Accessories

B3.
Stainless
Steel Ties

C1.
Wiring
Duct

C2.
Surface
Raceway

C3.
Abrasion
Protection

C4.
Cable
Management

D1.
Terminals

D2.
Power
Connectors

D3.
Grounding
Connectors

E1.
Labeling
Systems

E2.
Labels

E3.
Pre-Printed
& Write-On
Markers

E4.
Permanent
Identification

E5.
Lockout/
Tagout
& Safety
Solutions

F.
Index

A.
System
Overview

Laminated Steel Padlocks

B1.
Cable
Ties

- Laminated steel, pin tumbler lock
- Double-locking, case-hardened steel shackle
- Each lock keyed differently and supplied with two keys
- .28 inches (7.00mm) diameter shackle



B2.
Cable
Accessories

B3.
Stainless
Steel
Ties

C1.
Wiring
Duct

C2.
Surface
Raceway

C3.
Abrasion
Protection

C4.
Cable
Management

D1.
Terminals

D2.
Power
Connectors

D3.
Grounding
Connectors

E1.
Labeling
Systems

E2.
Labels

E3.
Pre-Printed
& Write-On
Markers

E4.
Permanent
Identification

E5.
Lockout/
Tagout/
& Safety
Solutions

F.
Index

Part Number	Color	Std. Pkg. Qty.
.75" (19.00mm) Shackle		
PSL-3BLACK	Lock with black bumper.	6
PSL-3BLUE	Lock with blue bumper.	6
PSL-3GREEN	Lock with green bumper.	6
PSL-3RED	Lock with red bumper.	6
PSL-3WHITE	Lock with white bumper.	6
PSL-3YELLOW	Lock with yellow bumper.	6
2.00" (51.00mm) Shackle		
PSL-3BLACK-LS	Lock with black bumper.	6
PSL-3BLUE-LS	Lock with blue bumper.	6
PSL-3GREEN-LS	Lock with green bumper.	6
PSL-3RED-LS	Lock with red bumper.	6
PSL-3WHITE-LS	Lock with white bumper.	6
PSL-3YELLOW-LS	Lock with yellow bumper.	6

These locks are not suitable for custom engraving.
See Custom Lock Options on page E5.20.

Value Line Padlocks

- Economical padlock has laminated steel body with case hardened, corrosion resistant steel shackle, and double steel ball locking system
- Each lock keyed differently and supplied with two keys and colored padlock label
- All locks have black bumpers and are supplied with color-coded self-laminating padlock labels
- .25 inches (6.00mm) diameter shackle



Part Number	Color	Std. Pkg. Qty.
.75" (19.00mm) Shackle		
PSL-5BLK	Black padlock label.	6
PSL-5BLU	Blue padlock label.	6
PSL-5GRN	Green padlock label.	6
PSL-5RED	Red padlock label.	6
PSL-5WHT	White padlock label.	6
PSL-5YEL	Yellow padlock label.	6
2.50" (63.50mm) Shackle		
PSL-5RED-LS	Red padlock label.	6

These locks not suitable for custom engraving and cannot be master keyed or keyed alike.
Labels are designed with blank write-on area for name and department designation and can be clearly identified with PANDUIT permanent marking pens on page E5.20.

Lockout Hasps

- Energy sources can be locked out quickly and easily by more than one worker for group lockout applications
- Heavy duty hasps with tamper-resistant designs to deter vandalism
- Variety of lockout hasp styles and sizes to accommodate a wide range of lockout applications

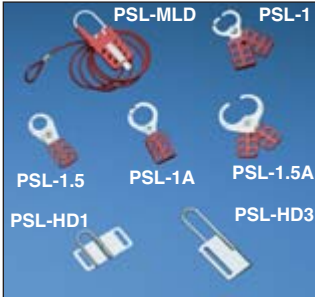

Part Number	Part Description	Max. No. Locks	Std. Pkg. Qty.	Std. Ctn. Qty.
PSL-MLD	Multiple lockout device; includes lockout hasp and 6.0' (1.8m) vinyl coated galvanized steel cable with loop-hole.	6	1	20
PSL-MLDH-X	Multiple lockout device (hasp only).	6	10	—
PSL-1	Hasp with 1.00" (25.40mm) diameter jaw and overlapping tabs.	6	12	144
PSL-1.5	Hasp with 1.50" (38.10mm) diameter jaw and overlapping tabs.	6	12	144
PSL-1A	Hasp with 1.00" (25.40mm) diameter jaw.	6	12	144
PSL-1.5A	Hasp with 1.50" (38.10mm) diameter jaw.	6	12	48
PSL-HD1	Heavy duty hasp with 1.00" x 1.00" (25.40mm x 25.40mm) clearance.	5	12	—
PSL-HD2.4	Heavy duty hasp with 1.00" x 2.40" (25.40mm x 60.00mm) clearance.	5	12	—
PSL-HD3	Heavy duty hasp with 1.00" x 3.00" (25.40mm x 76.00mm) clearance.	7	12	—

Self-Laminating Padlock Labels

- Used to identify employees' locks; employees sign the label, attach it to the padlock, and overwrap with the clear vinyl to protect the legend
- Available in six colors for departmental coding
- One-piece design is easy to use



Part Number	Color	Width		Height		Std. Pkg. Qty.	Std. Ctn. Qty.
		In.	mm	In.	mm		
PSL-PL1BLKY	Black	10.00	254.00	.75	19.00	25	150
PSL-PL1BLUY	Blue	10.00	254.00	.75	19.00	25	150
PSL-PL1GRNY	Green	10.00	254.00	.75	19.00	25	150
PSL-PL1REDY	Red	10.00	254.00	.75	19.00	25	150
PSL-PL1WHTY	White	10.00	254.00	.75	19.00	25	150
PSL-PL1YELY	Yellow	10.00	254.00	.75	19.00	25	150

Labels are designed with blank write-on area for name and department designation and can be clearly identified with *PANDUIT* permanent marking pens.

Custom Lock Options

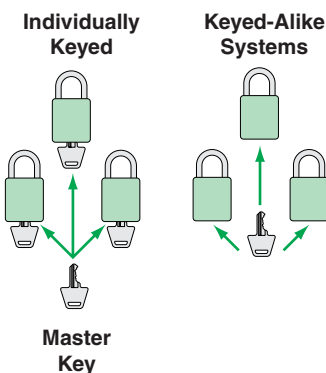

Padlocks are available with the following common lock options:

- Master keyed
- Keyed-alike
- Variety of lock sizes and shackle lengths
- Engraving available on PSL-4 Safety Lockout and PSL-11 High Security Padlocks

Note: Excludes PSL-5 Value Line Padlocks.

A. System Overview

B1. Cable Ties

B2. Cable Accessories

B3. Stainless Steel Ties

C1. Wiring Duct

C2. Surface Raceway

C3. Abrasion Protection

C4. Cable Management

D1. Terminals

D2. Power Connectors

D3. Grounding Connectors

E1. Labeling Systems

E2. Labels

E3. Pre-Printed & Write-On Markers

E4. Permanent Identification

E5. Lockout/Tagout & Safety Solutions

F. Index

A.
System
Overview

Metal I.D. Tags and Collars

B1.
Cable Ties



B2.
Cable
Accessories

B3.
Stainless
Steel Ties

Part Number	Part Description	Std. Pkg. Qty.	Std. Ctn. Qty.
PSL-TG1	Brass padlock identification tag.	12	48
PSL-SC	Padlock shackle collar and rivet.	12	48
MTB1D-Q	Marker tag, 1.00" circular, brass.	25	250
MT172W38-C	Marker tag, one hole, 304 Stainless Steel, rectangle, 1.72" x .38".	100	1000

C1.
Wiring
Duct

C2.
Surface
Raceway

Padlock Eyes

C3.
Abrasion
Protection

- Padlock eyes assist with compliance to OSHA standards requiring that equipment be modified to accept locks and lockout devices
- Surface mounted eyes are made of .13 inches (3.00mm) hard wrought steel
- Tamper resistant inside mounting eyes – 2.50 inches W (64.00mm), accept shackle diameters up to .63 inches (16.00mm)

C4.
Cable
Management



D1.
Terminals

D2.
Power
Connectors

D3.
Grounding
Connectors

Part Number	Part Description	Std. Pkg. Qty.	Std. Ctn. Qty.
PSL-PE1	Padlock eyes, angled (metal mounting screws included).	1	10
PSL-PE2	Padlock eyes, straight (wood mounting screws included).	1	10

E1.
Labeling
Systems

Chain Attachment

E2.
Labels

- Optional 9.00 inches (229.00mm) chain for permanently attaching lockouts at pre-designed locations

E3.
Pre-Printed
& Write-On
Markers



E4.
Permanent
Identification

E5.
Lockout/
Tagout/
& Safety
Solutions

Part Number	Part Description	Std. Pkg. Qty.	Std. Ctn. Qty.
PSL-PC	Heavy duty zinc plated steel chain with chain holder attached.	1	10

F.
Index

Write-On Safety Tags

- Meet OSHA Standard 1910.147 requirements for tagout applications
- Semi-rigid plastic tags are 3.00"W x 5.75"H (76.00mm x 146.00mm) with a .38" (9.00mm) brass grommet for greater strength and increased durability

- Tags can be attached with a lockout device or with a *PANDUIT* PLT2S nylon tie (50 lb. loop tensile strength) supplied with each tag
- PVT-* Package consists of five tags and five cable ties
- PVT*-Q Package consists of 25 tags and 25 cable ties
- Can be clearly identified with *PANDUIT* permanent marking pens



Material Chart

Material	Print Method	Temperature Range	Features
Rigid Vinyl	Pre-Printed	-40°F to 150°F (-40°C to 66°C)	Indoor/outdoor rated; rigid material accepts ink; resistant to UV light, chemical atmosphere, and abrasion; excellent for applications where adhesives will not work.

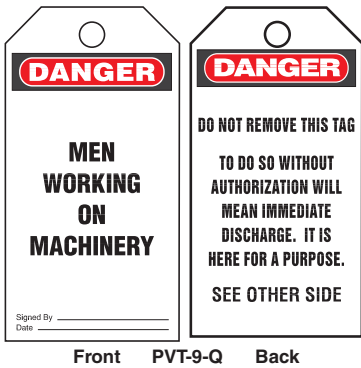

Front PVT-9-Q Back

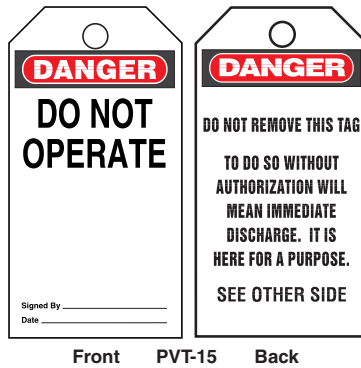

Front PVT-15 Back



Front PVT-23 Back PVT-23-Q

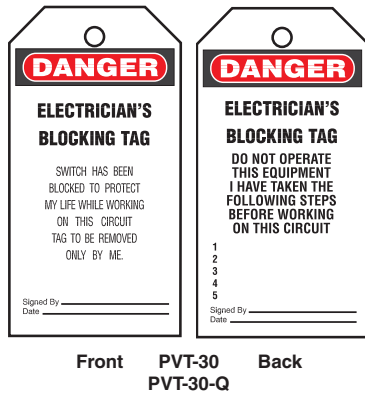

Front PVT-30 Back PVT-30-Q



Front PVT-41 Back



Front PVT-42-Q Back

A. System Overview

B1. Cable Ties

B2. Cable Accessories

B3. Stainless Steel Ties

C1. Wiring Duct

C2. Surface Raceway

C3. Abrasion Protection

C4. Cable Management

D1. Terminals

D2. Power Connectors

D3. Grounding Connectors

E1. Labeling Systems

E2. Labels

E3. Pre-Printed & Write-On Markers

E4. Permanent Identification

E5. Lockout/Tagout & Safety Solutions

F. Index

Tags continue on page E5.16.

A. System Overview

Write-On Safety Tags (continued)

B1. Cable Ties

B2. Cable Accessories

B3. Stainless Steel Ties

C1. Wiring Duct

C2. Surface Raceway

C3. Abrasion Protection

C4. Cable Management

D1. Terminals

D2. Power Connectors

D3. Grounding Connectors

E1. Labeling Systems

E2. Labels

E3. Pre-Printed & Write-On Markers

E4. Permanent Identification

E5. Lockout/Tagout & Safety Solutions

F. Index



Front PVT-43 Back



Front PVT-44 Back PVT-44-Q



Front PVT-56-Q Back

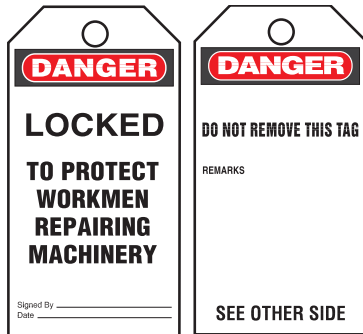

Front PVT-57-Q Back



Front PVT-62-Q Back

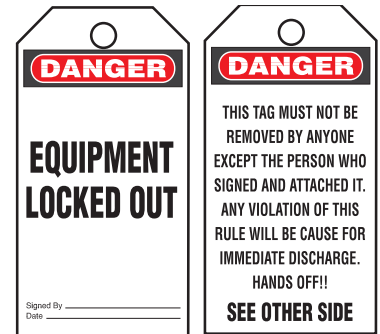

Front PVT-96 Back PVT-96-Q

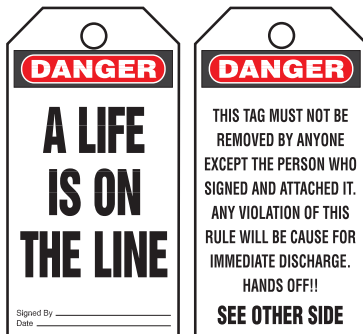

Front PVT-97 Back PVT-97-Q



Front PVT-98 Back PVT-98-Q

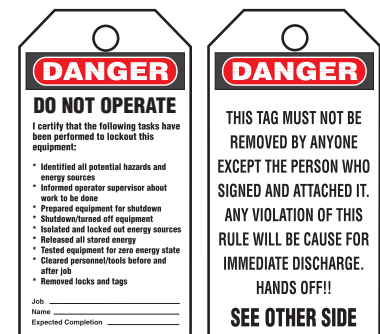

Front PVT-99 Back

Write-On Safety Tags (continued)

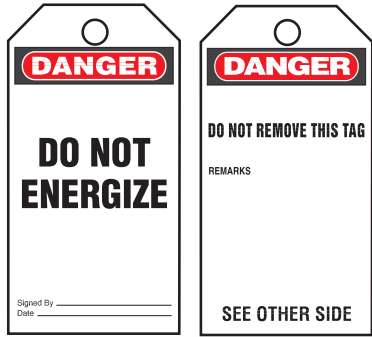

Front PVT-148-Q Back

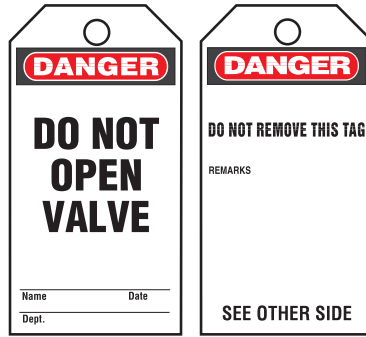

Front PVT-150-Q Back

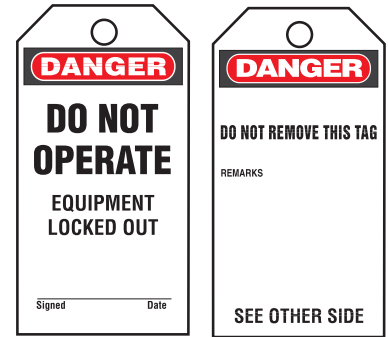

Front PVT-153-Q Back

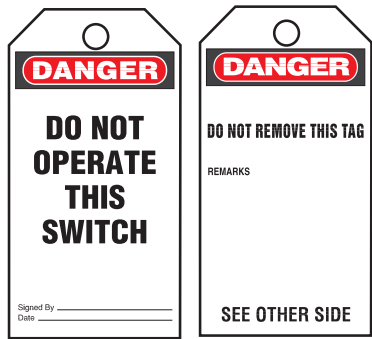

Front PVT-155-Q Back

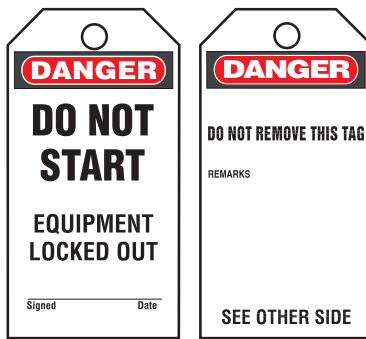

Front PVT-156-Q Back

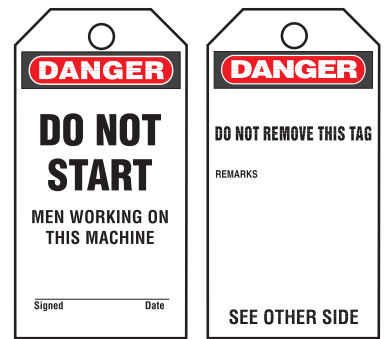

Front PVT-157-Q Back



Front PVT-158-Q Back



Front PVT-160-Q Back

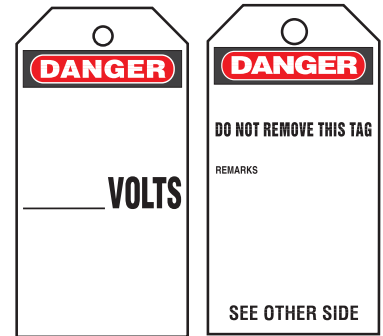

Front PVT-238-Q Back

A. System Overview

B1. Cable Ties

B2. Cable Accessories

B3. Stainless Steel Ties

C1. Wiring Duct

C2. Surface Raceway

C3. Abrasion Protection

C4. Cable Management

D1. Terminals

D2. Power Connectors

D3. Grounding Connectors

E1. Labeling Systems

E2. Labels

E3. Pre-Printed & Write-On Markers

E4. Permanent Identification

E5. Lockout/Tagout & Safety Solutions

F. Index

A.
System
Overview

Bilingual Write-On Safety Tags

B1.
Cable Ties

- Meet OSHA Standard 1910.147 requirements for tagout applications
- Semi-rigid plastic tags are 3.00"W x 5.75"H (76.00mm x 146.00mm) with a .38" (9.00mm) brass grommet for greater strength and increased durability

- Tags can be attached with a lockout device or with a *PANDUIT* PLT2S nylon tie (50 lb. loop tensile strength) supplied with each tag
- Package consists of 25 tags and 25 cable ties
- Can be clearly identified with *PANDUIT* permanent marking pens

B2.
Cable
Accessories

B3.
Stainless
Steel Ties

C1.
Wiring
Duct

C2.
Surface
Raceway



Front PVT-97S-Q Back



Front PVT-161-Q Back



Front PVT-165-Q Back

C3.
Abrasion
Protection

ISO Symbol Safety Tags

C4.
Cable
Management

- Meets International Organization for Standardization (ISO) to communicate safety information
- Semi-rigid plastic tags are 3.00"W x 5.75"H (76.00mm x 146.00mm) with a .38" (9.00mm) brass grommet for greater strength and durability

- Tags have write-on surface and can be attached with a lockout device or with a *PANDUIT* PLT2S nylon tie (50 lb. loop tensile strength) supplied with each tag
- Package consists of five tags and five cable ties
- Can be clearly identified with *PANDUIT* permanent marking pens

D1.
Terminals

D2.
Power
Connectors

D3.
Grounding
Connectors



Front PVT-110 Back
(Do Not Throw Switch)



Front PVT-111 Back
(Prohibition)



Front PVT-112 Back
(Warning of Dangerous
Electrical Voltage)

E1.
Labeling
Systems

E2.
Labels

Do It Yourself Tags

E3.
Pre-Printed
& Write-On
Markers

E4.
Permanent
Identification

E5.
Lockout/
Tagout/
& Safety
Solutions

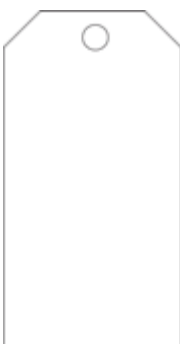

PVT-94-Q

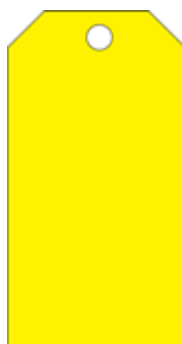

PVT-95-Q



PVT-113-Q



PVT-179-Q



PVT-118-Q

Self-Laminating Photo Tags

- Semi-rigid plastic tags with polyester laminate to protect photos and other written data are 3.00"W x 5.75"H (76.00mm x 146.00mm) with a .38" (9.00mm) brass grommet for greater strength and durability
- Tags have write-on surface and can be attached with a lockout device or with a *PANDUIT* PLT2S nylon tie (50 lb. loop tensile strength) supplied with each tag

- Package consists of five tags and five cable ties
- Can be clearly identified with *PANDUIT* permanent marking pens



Front PST-3 Back

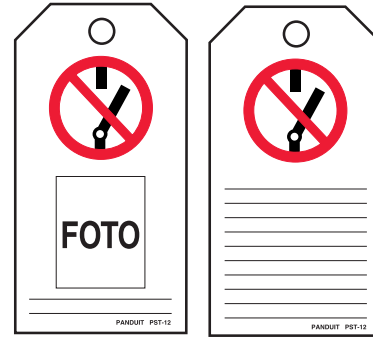

Front PST-12 Back

A. System Overview

B1. Cable Ties

B2. Cable Accessories

B3. Stainless Steel Ties

C1. Wiring Duct

C2. Surface Raceway

C3. Abrasion Protection

C4. Cable Management

D1. Terminals

D2. Power Connectors

D3. Grounding Connectors

E1. Labeling Systems

E2. Labels

E3. Pre-Printed & Write-On Markers

E4. Permanent Identification

E5. Lockout/Tagout & Safety Solutions

F. Index

A. System Overview

Permanent Marking Pens

- Fast drying, permanent ink – legible identification on nylon
- Used with marker ties, write-on labels and tags, where ordinary marking pens will not work



Part Number	Part Description	Ink Color	Std. Pkg. Qty.	Std. Ctn. Qty.
PFX-0	Permanent marking pen – fine tip.	Black	12	144
PFX-2	Permanent marking pen – fine tip.	Red	12	144

B1. Cable Ties

B2. Cable Accessories

B3. Stainless Steel Ties

Lockout/Tagout Safety Signs

Indoor/Outdoor Sub-Surface Printed Adhesive Polyester (Type PPS)

- High quality signs for use indoors and outdoors
- Excellent resistance to UV light, chemical atmosphere, and abrasion
- Excellent life and adhesion properties
- Printed graphics are protected by clear polyester laminate

Indoor/Outdoor Rigid Polyethylene (Type PRS)

- Rugged signs for indoors and outdoors
- Abrasion resistant
- Used where adhesives will not work

Indoor Adhesive Vinyl (Type PVS)

- Economical general purpose signs for use in most environments
- Very good adhesive properties when applied to a clean, dry surface

C1. Wiring Duct

C2. Surface Raceway

C3. Abrasion Protection

C4. Cable Management



D1. Terminals

D2. Power Connectors

Material Chart

Material	Print Method	Temperature Range	Features
Polyester (PPS)	Pre-Printed	-40°F to 275°F (-40°C to 135°C)	Indoor/outdoor rated; laminated label material protects legend from abrasion and chemicals; resistant to UV light, chemical atmosphere, and abrasion; excellent life and adhesion properties.
Rigid Polyethylene (PRS)		-105°F to 250°F (-76°C to 121°C)	Indoor/outdoor rated; high quality, rugged material resistant to abrasion; use where adhesives will not work.
Vinyl (PVS)		-40°F to 200°F (-40°C to 93°C)	Indoor rated; economical general purpose material; excellent adhesion properties when applied to a clean, dry surface.

D3. Grounding Connectors

Size Reference Chart

Part Number	Width		Height		Signs per Card
	In.	mm	In.	mm	
0109	9.00	228.60	1.50	38.10	1
0204	4.50	114.30	2.25	57.15	2
0209	9.00	228.60	2.25	57.15	1
0305	5.00	127.00	3.50	88.90	1
0503	3.00	76.20	5.00	127.00	2
0507	7.00	177.80	5.00	127.00	1
0509	9.00	228.60	5.00	127.00	1
0710	10.00	254.00	7.00	177.80	1
1014	14.00	355.60	10.00	254.00	1

*Denotes the part numbers' prefix and suffix.



PPS0204W2100
PPS0305W2100
PPS0507W2100



PVS0305W2101^
PVS0507W2101^



PRS1014B364
PVS0509B364Y
PVS0710B364Y
PPS0710B364
PRS0710B364



PPS0710D72
PRS0710D72
PRS1014D72
PVS0109D72Y
PVS0204D72Y
PVS0710D72Y

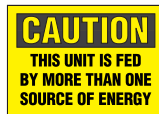

PVS0305C174Y
PVS0505C174Y
PPS0305C174



PVS0710C173Y



PVS0204D100Y



PVS0209D445Y



PVS0204C171Y



PVS0710C180Y

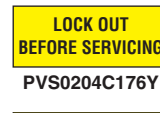

PVS0204C176Y



PVS0204C177Y



PVS0204C179Y



PVS0204W172Y



PVS0204C178Y

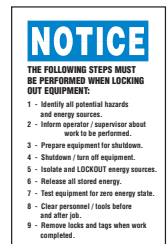

PVS0503N458Y

E1. Labeling Systems

E2. Labels

E3. Pre-Printed & Write-On Markers

E4. Permanent Identification

E5. Lockout/Tagout & Safety Solutions

F. Index

^Can be clearly identified with PANDUIT permanent marking pens.

SAFETY AND FACILITY IDENTIFICATION

PANDUIT offers a full line of safety and facility identification products to ensure employee safety with an effectively identified workplace.



- Safety signs and labels offered in a variety of materials, colors, sizes and legends
- Voltage markers in adhesive and snap-on style
- Utility tapes in a variety of materials, colors, sizes and legends
- Letters and numbers in a variety of materials and sizes
- Tags in a variety of materials, colors, sizes and legends

PANDUIT safety and facility identification products are designed to assist you with creating a safe, compliant, and efficient workplace.

A.
System
Overview

B1.
Cable Ties

B2.
Cable
Accessories

B3.
Stainless
Steel Ties

C1.
Wiring
Duct

C2.
Surface
Raceway

C3.
Abrasion
Protection

C4.
Cable
Management

D1.
Terminals

D2.
Power
Connectors

D3.
Grounding
Connectors

E1.
Labeling
Systems

E2.
Labels

E3.
Pre-Printed
& Write-On
Markers

E4.
Permanent
Identification

E5.
Lockout/
Tagout
& Safety
Solutions

F.
Index

A. System Overview

Electrical Hazard Safety Signs

B1. Cable Ties



B2. Cable Accessories

B3. Stainless Steel Ties

Material Chart

Material	Print Method	Temperature Range	Features
Polyester (PPS)	Pre-Printed	-40°F to 275°F (-40°C to 135°C)	Indoor/outdoor rated; laminated label material protects legend from abrasion and chemicals; resistant to UV light, chemical atmosphere, and abrasion; excellent life and adhesion properties.
Rigid Polyethylene (PRS)		-105°F to 250°F (-76°C to 121°C)	Indoor/outdoor rated; high quality, rugged material resistant to abrasion; use where adhesives will not work.
Vinyl (PVS)		-40°F to 200°F (-40°C to 93°C)	Indoor rated; economical general purpose material; excellent adhesion properties when applied to a clean, dry surface.

C1. Wiring Duct

Size Reference Chart

Part Number	Width		Height		Signs Per Card
	In.	mm	In.	mm	
0109	9.00	228.60	1.50	38.10	1
0204	4.50	114.30	2.25	57.15	2
0305	5.00	127.00	3.50	88.90	1
0507	7.00	177.80	5.00	127.00	1
0509	9.00	228.60	5.00	127.00	1
0514	14.00	355.60	5.00	127.00	1
0710	10.00	254.00	7.00	177.80	1
1007	10.00	254.00	7.00	177.80	1
1014	14.00	355.60	10.00	254.00	1
1420	20.00	508.00	14.00	355.60	1

*Denotes the part numbers' prefix and suffix.

C2. Surface Raceway

C3. Abrasion Protection

C4. Cable Management

D1. Terminals

D2. Power Connectors

D3. Grounding Connectors

E1. Labeling Systems

E2. Labels

E3. Pre-Printed & Write-On Markers

E4. Permanent Identification

E5. Lockout/Tagout & Safety Solutions

F. Index



PPS0204W2100
PPS0305W2100
PPS0507W2100



PVS0305W2101Y^
PVS0507W2101Y^

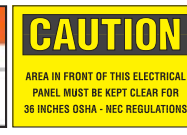

PPS0710C141



PPS0710D28^



PPS0710D66



PRS0710D68



PPS0710D70
PRS1014D70



PRS1014D71



PPS0710D101



PPS0710D72
PRS0710D72
PRS1014D72
PVS0109D72Y
PVS0204D72Y
PVS0710D72Y



PPS0305D73
PPS0710D73
PRS1014D73
PRS1014D73



PPS0305D75
PPS0710D75
PRS1420D75



PPS0710D77



PVS0204D100Y

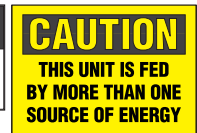

PPS0305C174
PVS0305C174Y
PVS0505C174Y



PPS100D72SE



PPS0710D24



PPS0514B363



PPS0710B364
PRS0710B364
PRS1014B364
PVS0509B364Y
PVS0710B364Y



PRS1014D79



PRS0910D453



PPS0710N203

^ Can be clearly identified with PANDUIT permanent marking pens.



Short Circuit Warning Signs

- Aids in compliance with UL 508A requirement



PPS0305W2200
PPS0507W2200

Material Chart

Material	Print Method	Temperature Range	Features
Polyester (PPS)	Pre-Printed	-40°F to 275°F (-40°C to 135°C)	Indoor/outdoor rated; laminated label material protects legend from abrasion and chemicals; resistant to UV light, chemical atmosphere, and abrasion; excellent life and adhesion properties.

Size Reference Chart

Part Number	Width		Height		Signs Per Card
	In.	mm	In.	mm	
0305	5.00	127.00	3.00	76.20	5
0507	7.00	177.80	5.00	127.00	5
0710	10.00	254.00	7.00	177.80	1
1014	14.00	355.60	10.00	254.00	1
1209	9.00	228.60	12.00	304.80	1

*Denotes the part numbers' prefix and suffix.

Photoluminescent Safety Signs

- Used to mark egress routes, fire alarms, and fire equipment that is clearly visible for up to ten hours after power is lost
- Absorbs energy from ambient light and releases this energy in the form of a glow when power is lost
- *PANDUIT* Photoluminescent Signs meet or exceed the following safety standard specification for photoluminescent safety markings including: ASTM E 2072-00, ASTM E 2073-00, ASTM E 2030-99, DIN67510-1, IMO Resolution A.752.18, ISO/CD 15370, DIN 67510, UL 924, ASTM 162, ASTM 648, ASTM 662, MIL-L-3891 B,



PPS0710G001
PPS1014G002



PPS0710G020



PPS1209G010



PPS1209G011



PPS1209G012

Electrical Symbols on Cards

Material Chart

Material	Print Method	Temperature Range	Features
Vinyl Cloth	Pre-Printed	-50°F to 170°F (-46°C to 77°C)	Indoor/outdoor rated; conformable material with repositionable adhesive allows label to be removed and reused or used in temporary applications; provides durability, high temperature resistance, and dimensional stability for rough or textured surfaces.

Part Number	Symbol	Description	Marker Size		Markers Per Card	Std. Pkg. Card(s)	Std. Ctn. Card(s)
			In.	mm			
PESC-H-AT		WARNING OF DANGEROUS ELECTRICAL VOLTAGE	.51 x .51	13.00 x 13.00	68	10	100
PESC-J-AT			.75 x .75	19.00 x 19.00	36	10	100
PESC-H-E		EARTH (GROUND)	.51 x .51	13.00 x 13.00	68	10	200
PESC-J-E			.75 x .75	19.00 x 19.00	36	10	100
PESC-H-EC		SAFETY FUNCTION	.51 x .51	13.00 x 13.00	68	10	200
PESC-J-EC			.75 x .75	19.00 x 19.00	36	10	100
PESC-H-HT		STATIC SENSITIVE DEVICE - HANDLING PRECAUTIONS REQUIRED	.51 x .51	13.00 x 13.00	68	10	100
PESC-J-HT			.75 x .75	19.00 x 19.00	36	10	100
PESC-H-PE		PROTECTIVE CONDUCTOR	.51 x .51	13.00 x 13.00	68	10	100
PESC-J-PE			.75 x .75	19.00 x 19.00	36	10	100

Order number of cards required.

Order number of pieces required, in multiples of Standard Package Quantity.

Prime items appear in **BOLD**.

A. System Overview

B1. Cable Ties

B2. Cable Accessories

B3. Stainless Steel Ties

C1. Wiring Duct

C2. Surface Raceway

C3. Abrasion Protection

C4. Cable Management

D1. Terminals

D2. Power Connectors

D3. Grounding Connectors

E1. Labeling Systems

E2. Labels

E3. Pre-Printed & Write-On Markers

E4. Permanent Identification

E5. Lockout/Tagout & Safety Solutions

F. Index

A.
System
Overview

Conductor Identification Labels

B1.
Cable Ties

Material Chart

Material	Print Method	Temperature Range	Features
Polyester	Pre-Printed	-40°F to 250°F (-40°C to 121°C)	Indoor/outdoor rated; laminated label material protects legend from abrasion and chemicals; resistant to UV light, chemical atmosphere, and abrasion; excellent life and adhesion properties

B2.
Cable
Accessories

B3.
Stainless
Steel Ties

C1.
Wiring
Duct

C2.
Surface
Raceway

C3.
Abrasion
Protection

C4.
Cable
Management

D1.
Terminals

D2.
Power
Connectors

D3.
Grounding
Connectors

E1.
Labeling
Systems











E2.
Labels

E3.
Pre-Printed
& Write-On
Markers

E4.
Permanent
Identification

E5.
Lockout/
Tagout
& Safety
Solutions

F.
Index

Part Number	Symbol	Legend	Marker Diameter		Labels Per Sheet	Std. Pkg. Sheet(s)	Std. Ctn. Sheet(s)
			In.	mm			
PESS-A-CE		CE SYMBOL	.49	12.50	20	10	100
PESS-B-CE			.63	16.00	20	10	100
PESS-C-CE			.79	20.00	10	10	100
PESS-D-CE			.98	25.00	10	10	100
PESS-E-CE			1.24	31.50	10	10	100
PESS-A-ES		EARTH (GROUND)	.49	12.50	20	10	100
PESS-B-ES			.63	16.00	20	10	100
PESS-C-ES			.79	20.00	10	10	100
PESS-D-ES			.98	25.00	10	10	100
PESS-E-ES			1.24	31.50	10	10	100
PESS-A-L1		OUTER CONDUCTOR – L1	.49	12.50	20	10	100
PESS-B-L1			.63	16.00	20	10	100
PESS-C-L1			.79	20.00	10	10	100
PESS-D-L1			.98	25.00	10	10	100
PESS-E-L1			1.24	31.50	10	10	100
PESS-A-L2		OUTER CONDUCTOR 2 – L2	.49	12.50	20	10	100
PESS-B-L2			.63	16.00	20	10	100
PESS-C-L2			.79	20.00	10	10	100
PESS-D-L2			.98	25.00	10	10	100
PESS-E-L2			1.24	31.50	10	10	100
PESS-A-L3		OUTER CONDUCTOR 3 – L3	.49	12.50	20	10	100
PESS-B-L3			.63	16.00	20	10	100
PESS-C-L3			.79	20.00	10	10	100
PESS-D-L3			.98	25.00	10	10	100
PESS-E-L3			1.24	31.50	10	10	100
PESS-A-LF		LEAD FREE SYMBOL	.49	12.50	20	10	100
PESS-A-N		NEUTRAL CONDUCTOR – N	.49	12.50	20	10	100
PESS-B-N			.63	16.00	20	10	100
PESS-C-N			.79	20.00	10	10	100
PESS-D-N			.98	25.00	10	10	100
PESS-A-PE		PROTECTIVE CONDUCTOR – PE	.49	12.50	20	10	100
PESS-A-ROHS		RoHS WHEELED BIN SYMBOL	.49	12.50	20	10	100
PESS-A-SS		SAFETY FUNCTION	.49	12.50	20	10	100
PESS-B-SS			.63	16.00	20	10	100
PESS-C-SS			.79	20.00	10	10	100
PESS-D-SS			.98	25.00	10	10	100

Order number of cards required.





ISO Warning Symbols

Material Chart







Material	Print Method	Temperature Range	Features
Paper (WL1, WL3)	Pre-Printed	-65°F to 200°F (-54°C to 80°C)	Indoor rated; general purpose and material; excellent adhesion properties when applied to a clean, dry surface.
Polyester (WL25)		-40°F to 250°F (-54°C to 93°C)	Indoor/outdoor rated; laminated label material protects legend from abrasion and chemicals; resistant to UV light, chemical atmosphere, and abrasion; excellent life and adhesion properties.
Vinyl (PESW, WL32Y, WL33Y, WL35Y, WL36Y)		-40°F to 176°F (-40°C to 80°C)	Indoor/outdoor rated; laminated label material protects legend from abrasion and chemicals; resistant to UV light, chemical atmosphere, and abrasion; excellent life and adhesion properties.

Part Number	Symbol	Description	Triangle Width		Markers Per Card/Pkg	Std. Pkg. Card(s)	Std. Ctn. Card(s)
			In.	mm			

Cards

PESW-A-1Y		CAUTION – RISK OF ELECTRIC SHOCK	.50	13.00	10	10	200
PESW-B-1Y			1.00	25.40	10	10	200
PESW-C-1Y			1.97	50.00	10	10	200
PESW-D-1Y			3.90	99.06	3	10	200
PESW-E-1Y			7.90	200.66	1	10	200
PESW-A-6Y		CAUTION – RISK OF IONIZING RADIATION	.50	13.00	10	10	100
PESW-B-6Y			1.00	25.40	10	10	100
PESW-C-6Y			1.97	50.00	10	10	100
PESW-D-6Y			3.90	99.06	3	10	100
PESW-E-6Y			7.90	200.66	1	10	100
PESW-A-8Y		CAUTION – LASER BEAM	.50	13.00	10	10	200
PESW-B-8Y			1.00	25.40	10	10	200
PESW-C-8Y			1.97	50.00	10	10	100
PESW-D-8Y			3.90	99.06	3	10	100
PESW-E-8Y			7.90	200.66	1	10	100
PESW-A-9Y		CAUTION – GENERAL WARNING, RISK OF DANGER	.50	13.00	10	10	200
PESW-B-9Y			1.00	25.40	10	10	200
PESW-C-9Y			1.97	50.00	10	10	100
PESW-D-9Y			3.90	99.06	3	10	100
PESW-E-9Y			7.90	200.66	1	10	100
PESW-A-11Y		WARNING OF STATIC SENSITIVE DEVICE	.50	13.00	10	10	100
PESW-B-11Y			1.00	25.40	10	10	100
PESW-C-11Y			1.97	50.00	10	10	100
PESW-D-11Y			3.90	99.06	3	10	100
PESW-E-11Y			7.90	200.66	1	10	100

Rolls

WL1		STATIC AWARENESS WARNING	2.00	50.80	500	1	10
WL3			2.00	50.80	500	1	10
WL25		WARNING ACCESS TO THIS PANEL ...	3.50	88.90	50	1	10
WL32Y		RISK OF ELECTRIC SHOCK SYMBOL	1.50	38.10	50	1	10
WL33Y			4.50	114.30	50	1	10
WL35Y		CAUTION – HOT SURFACE WARNING	2.00	50.80	50	1	10
WL36Y		WARNING – HOT SURFACE WARNING	2.00	50.80	50	1	10

A. System Overview

Electrical Labels in Dispenser



Material Chart

Material	Print Method	Temperature Range	Features
Polyester	Pre-Printed	-40°F to 250°F (-40° to 121°C)	Indoor/outdoor rated; laminated label material protects legend from abrasion and chemicals; resistant to UV light chemical atmosphere and abrasion; excellent life and adhesion properties.

B1. Cable Ties

B2. Cable Accessories

B3. Stainless Steel Ties

Part Number	Symbol	Description	Width		Height		Labels Per Pkg.	Std. Pkg. Dispenser(s)	Std. Ctn. Dispenser(s)
			In.	mm	In.	mm			

Dispensers

C1. Wiring Duct	PLD-12 [^]		CIRCUIT NO., LOCATION	1.50	38.10	1.00	25.40	200	1	10
C2. Surface Raceway	PLD-30 [^]		CAUTION	1.50	38.10	1.00	25.40	200	1	10
	PLD-36		CAUTION 120 V	1.50	38.10	1.00	25.40	200	1	10
C3. Abrasion Protection	PLD-37		CAUTION 220 V	1.50	38.10	1.00	25.40	200	1	10
	PLD-38		CAUTION 240 V	1.50	38.10	1.00	25.40	200	1	10
	PLD-43 [^]		DANGER HIGH VOLTAGE	1.50	38.10	1.00	25.40	200	1	10
C4. Cable Management	PLD-45		CAUTION 230 V	1.50	38.10	1.00	25.40	200	1	10
	PLD-46		CAUTION 277 V	1.50	38.10	1.00	25.40	200	1	10
	PLD-47		CAUTION 277/480 V	1.50	38.10	1.00	25.40	200	1	10
	PLD-52		ATTENTION SYMBOL (ISO 3864)	1.50	38.10	1.00	25.40	200	1	10
D1. Terminals	PLD-56		HIGH VOLTAGE SYMBOL (ISO 3864)	1.50	38.10	1.00	25.40	200	1	10
D2. Power Connectors	PLD-57		GROUND SYMBOL (ISO 3864)	.75	19.10	.75	19.10	300	1	10
	PLD-58		STATIC AWARENESS WARNING	1.50	38.10	1.00	25.40	200	1	10
D3. Grounding Connectors	PLD-60		STATIC AWARENESS WARNING	3.00	76.20	1.00	25.40	100	1	10
	PLD-67		DANGER HIGH VOLTAGE	1.50	38.10	1.00	25.40	200	1	10
E1. Labeling Systems	PLD-68 [^]		LOCKOUT BY _____ DATE _____	1.50	38.10	1.00	25.40	200	1	10
E2. Labels	PLD-71		WARNING - FOR CONTINUED PROTECTION ...	2.00	50.80	1.00	25.40	150	1	10
	PLD-72		CAUTION LOCK OUT FOR SAFETY BEFORE ...	1.50	38.10	1.00	25.40	200	1	10
E3. Pre-Printed & Write-On Markers	PLD-74		CAUTION HAZARD OF ELECTRIC SHOCK ...	1.50	38.10	1.00	25.40	200	1	10
E4. Permanent Identification	PLD-80		INTRINSICALLY SAFE WIRING	1.00	25.40	1.50	38.10	200	1	10
	PLD-81		SERVICE DISCONNECT	1.50	38.10	1.00	25.40	200	1	10
E5. Lockout/Tagout & Safety Solutions	PLD-91		CAUTION 480 V	1.50	38.10	1.00	25.40	200	1	10

F. Index





Order number of dispensers required in multiples of Std. Pkg.
[^]Can be clearly identified with PANDUIT permanent marking pens.

Write-On Labels on Cards

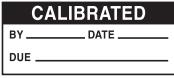

Material Chart

Material	Print Method	Temperature Range	Features
Vinyl Cloth	Pre-Printed	-50°F to 170°F (-46°C to 77°C)	Indoor/outdoor rated; conformable material with repositionable adhesive allows label to be removed and reused or used in temporary applications; provides durability, high temperature resistance, and dimensional stability for rough or textured surfaces.

Part Number	Symbol	Description	Width		Height		Markers Per Card	Std. Pkg. Card(s)	Std. Ctn. Card(s)
			In.	mm	In.	mm			
PCWL-BL		BLANK						25	100
PCWL-ACC		ACCEPTED						25	100
PCWL-CAL		CALIBRATION						25	100
PCWL-CALD		CALIBRATED	1.50	38.10	.63	15.90	14	25	100
PCWL-ICAL		CALIBRATION						25	100
PCWL-REJ		REJECTED						25	100

Order number of cards required.
Can be clearly identified with *PANDUIT* permanent marking pens.

A.
System
Overview

B1.
Cable Ties

B2.
Cable
Accessories

B3.
Stainless
Steel Ties

C1.
Wiring
Duct

C2.
Surface
Raceway

C3.
Abrasion
Protection

C4.
Cable
Management

D1.
Terminals

D2.
Power
Connectors

D3.
Grounding
Connectors

E1.
Labeling
Systems

E2.
Labels

E3.
Pre-Printed
& Write-On
Markers

E4.
Permanent
Identification

E5.
Lockout/
Tagout/
& Safety
Solutions

F.
Index

A.
System
Overview

Write-On Quality Labels in Dispenser

B1.
Cable Ties

B2.
Cable
Accessories

B3.
Stainless
Steel Ties



Material Chart

Material	Print Method	Temperature Range	Features
Polyester	Pre-Printed	-40°F to 250°F (-40° to 121°C)	Indoor/outdoor rated; laminated label material protects legend from abrasion and chemicals; resistant to UV light, chemical atmosphere, and abrasion; excellent life and adhesion properties.

C1.
Wiring
Duct

C2.
Surface
Raceway

C3.
Abrasion
Protection

C4.
Cable
Management

D1.
Terminals

D2.
Power
Connectors

D3.
Grounding
Connectors

E1.
Labeling
Systems

E2.
Labels

E3.
Pre-Printed
& Write-On
Markers

E4.
Permanent
Identification

E5.
Lockout/
Tagout/
& Safety
Solutions

F.
Index

Part Number	Symbol	Legend	Width		Height		Labels Per Dispenser	Std. Pkg. Dispenser(s)	Std. Ctn. Dispenser(s)
			In.	mm	In.	mm			
PLD-17		BLANK	1.50	38.10	1.00	25.40	200	1	10
PLD-18		BLANK						1	10
PLD-3		CALIBRATION, BY, DATE, DUE						1	10
PLD-4		ACCEPTED, BY, DATE						1	10
PLD-7		TESTED, DATE, BY						1	10
PLD-11		DO NOT USE AFTER						1	10
PLD-22		CALIBRATION, BY, DATE, DUE						1	10
PLD-28		INSPECTED, DATE, INITIALS						1	10
PLD-29		MAINTENANCE, BY, DATE						1	10

Order number of dispensers required in multiples of Std. Pkg.
Can be clearly identified with *PANDUIT* permanent marking pens.

Inspection Plates

Material Chart

Material	Print Method	Temperature Range	Features
Destructible Vinyl	Pre-Printed	-50°F to 225°F (-46°C to 107°C)	Indoor/outdoor rated; label will destruct upon removal; for permanent and tamper resistant labeling applications.

Part Number	Symbol	Year	Marker Diameter		Markers Per Card	Std. Pkg. Card(s)	Std. Ctn. Card(s)
			In.	mm			
PEIP-A-08Y		08	.59	15.00	10	10	100
PEIP-A-09Y		09	.59	15.00	10	10	100
PEIP-A-10Y		10	.59	15.00	10	10	100
PEIP-A-11Y		11	.59	15.00	10	10	100
PEIP-D-08Y		2008	1.38	35.00	5	10	100
PEIP-D-09Y		2009	1.38	35.00	5	10	100
PEIP-D-10Y		2010	1.38	35.00	5	10	100
PEIP-D-11Y		2011	1.38	35.00	5	10	100

Inspection Arrows

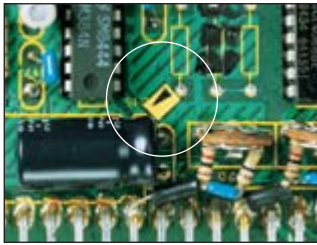

Material Chart

Material	Print Method	Temperature Range	Features
Vinyl Cloth	Pre-Printed	-50°F to 170°F (-46°C to 77°C)	Indoor/outdoor rated; conformable material with repositionable adhesive allows label to be removed and reused or used in temporary applications; provides durability, high temperature resistance, and dimensional stability for rough or textured surfaces.

Part Number	Symbol	Width		Height		Markers Per Card	Std. Pkg. Card(s)	Std. Pkg. Card(s)
		In.	mm	In.	mm			
PARW125-RED		.13	3.00	.19	5.00	576	25	—
PARW125-YEL		.13	3.00	.19	5.00	576	25	100

A.
System
Overview

B1.
Cable
Ties

B2.
Cable
Accessories

B3.
Stainless
Steel Ties

C1.
Wiring
Duct

C2.
Surface
Raceway

C3.
Abrasion
Protection

C4.
Cable
Management

D1.
Terminals

D2.
Power
Connectors

D3.
Grounding
Connectors

E1.
Labeling
Systems

E2.
Labels

E3.
Pre-Printed
& Write-On
Markers

E4.
Permanent
Identification

E5.
Lockout/
Tagout
& Safety
Solutions

F.
Index

A. System Overview

Voltage and Fiber Optic Markers

B1. Cable Ties



B2. Cable Accessories

B3. Stainless Steel Ties

C1. Wiring Duct

C2. Surface Raceway

C3. Abrasion Protection

C4. Cable Management

D1. Terminals

D2. Power Connectors

D3. Grounding Connectors

E1. Labeling Systems

E2. Labels

E3. Pre-Printed & Write-On Markers

E4. Permanent Identification

E5. Lockout/Tagout & Safety Solutions

F. Index

Style	Width		Length		Pipe/Conduit O.D. Range		Markers Per Card
	In.	mm	In.	mm	In.	mm	
A	9.00	228.00	2.25	57.10	3.00 and Over	76.20 and Over	1
B	4.50	114.30	1.13	28.60	1.25 – 3.00	31.70 – 76.20	4
C	2.20	57.10	.50	12.70	1.25 – Under	31.70 and Under	18

Material Chart

Material	Print Method	Temperature Range	Features
Polyester	Pre-Printed	-40°F to 275F (-40°C to 135°C)	Indoor/outdoor rated; pre-coiled material protects legend from abrasion and chemicals; resistant to UV light, chemical atmosphere, and abrasion.

Part Number			Legend	Color (Legend/Background)	Std. Pkg. Qty.	Std. Ctn. Qty.
Style A	Style B	Style C				
PCV-110AY	PCV-110BY	PCV-110CY	110 Volts	Black/Orange	5	50
PCV-115AY	PCV-115BY	PCV-115CY	115 Volts			
PCV-120/208AY	PCV-120/208BY	PCV-120/208CY	120/208 Volts			
PCV-120AY	PCV-120BY	PCV-120CY	120 Volts			
PCV-12470AY	PCV-12470BY	PCV-12470CY	12470 Volts			
PCV-13200AY	PCV-13200BY	PCV-13200CY	13200 Volts			
PCV-13800AY	PCV-13800BY	PCV-13800CY	13800 Volts			
PCV-1PHAY	PCV-1PHBY	PCV-1PHCY	Single Phase			
PCV-208AY	PCV-208BY	PCV-208CY	208 Volts			
PCV-220AY	PCV-220BY	PCV-220CY	220 Volts			
PCV-2300AY	PCV-2300BY	PCV-2300CY	2300 Volts			
PCV-230AY	PCV-230BY	PCV-230CY	230 Volts			
PCV-2400AY	PCV-2400BY	PCV-2400CY	2400 Volts			
PCV-240AY	PCV-240BY	PCV-240CY	240 Volts			
PCV-277/480AY	PCV-277/480BY	PCV-277/480CY	277/480 Volts			
PCV-277AY	PCV-277BY	PCV-277CY	277 Volts			
PCV-380AY	PCV-380BY	PCV-380CY	380 Volts			
PCV-3PHAY	PCV-3PHBY	PCV-3PHCY	Three Phase			
PCV-415AY	PCV-415BY	PCV-415CY	415 Volts			
PCV-4160AY	PCV-4160BY	PCV-4160CY	4160 Volts			
PCV-440AY	PCV-440BY	PCV-440CY	440 Volts			
PCV-460AY	PCV-460BY	PCV-460CY	460 Volts			
PCV-480AY	PCV-480BY	PCV-480CY	480 Volts			
PCV-600AY	PCV-600BY	PCV-600CY	600 Volts			
PCV-BLANKAY	PCV-BLANKBY	PCV-BLANKCY	Blank – No Legend			
PCV-ESAY	PCV-ESBY	PCV-ESCY	Emergency Service			
PCV-FAAY	PCV-FABY	PCV-FACY	Fire Alarm			
PCV-FOAY	PCV-FOBY	PCV-FOCY	Fiber Optic			
PCV-FOCAAY	PCV-FOCBY	PCV-FOCCY	Fiber Optic Cable			
PCV-MAINAY	PCV-MAINBY	PCV-MAINCY	Main			
PCV-TELEAY	PCV-TELEBY	PCV-TELECY	Telephone			

Style	Width		Length		Pipe/Conduit O.D. Range		Markers Per Card
	In.	mm	In.	mm	In.	mm	
M	14.00	355.60	23.00	584.20	2.25 – 6.00	57.20 – 152.40	1
R	8.00	230.20	8.00	230.20	.75 – 2.25	19.10 – 57.20	1

Part Number		Legend	Color (Legend/Background)	Std. Pkg. Qty.	Std. Ctn. Qty.
Style M	Style R				
	PCV-120RY	120 Volts	Black/Orange	1	25
	PCV-480RY	480 Volts		1	25
PCV-FOMY	PCV-FORY	Fiber Optic		1	25

Voltage and Safety Marker Books



Material Chart

Material	Print Method	Temperature Range	Features
Vinyl	Pre-Printed	-40°F to 200°F (-40°C to 93°C)	Indoor rated; economical general purpose material; excellent adhesion properties when applied to a clean, dry surface.

Part Number	Legend	Markers Per Page	Markers Per Book	Std. Qty. Book(s)
-------------	--------	------------------	------------------	-------------------

Voltage Markers

1.50" x 3.25" (38.00mm x 82.00mm)

Part Number	Legend	Markers Per Page	Markers Per Book	Std. Qty. Book(s)
PCVB-110-Y	110 Volts	3	30	1
PCVB-220-Y	220 Volts			
PCVB-277-Y	277 Volts			
PCVB-277/480-Y	277/480 Volts			
PCVB-440-Y	440 Volts			
PCVB-480-Y	480 Volts			
PCVB-4160-Y	4160 Volts			

Safety Markers

1.50" x 3.25" (38.00 mm x 82.00mm)

Part Number	Legend	Markers Per Page	Markers Per Book	Std. Qty. Book(s)
PSSB-13	Danger High Voltage	3	30	1

Hazard Tape

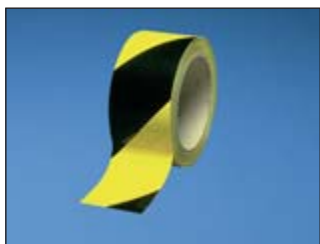

Material Chart

Material	Print Method	Temperature Range	Features
Vinyl	Pre-Printed	-20°F to 175°F (-29°C to 79°C)	Indoor rated; color-coded for quick identification; can be used in place of paint; excellent adhesion properties when applied to a clean, dry surface.

Part Number	Part Description	Width		Length		Std. Pkg. Qty.	Std. Ctn. Qty.
		In.	mm	Ft.	m		
HT2S-BLK-YEL	Black/yellow stripe, adhesive continuous tape.	2.00	50.80	54.0	16.5	1	12
HT2S-RED-WHT	Red/white striped, adhesive continuous tape.	2.00	50.80	54.0	16.5	1	12
HT3S-BLK-YEL	Black/yellow striped, adhesive continuous tape.	3.00	76.20	54.0	16.5	1	10
HT3S-RED-WHT	Red/white striped, adhesive continuous tape.	3.00	76.20	54.0	16.5	1	10

A. System Overview

B1. Cable Ties

B2. Cable Accessories

B3. Stainless Steel Ties

C1. Wiring Duct

C2. Surface Raceway

C3. Abrasion Protection

C4. Cable Management

D1. Terminals

D2. Power Connectors

D3. Grounding Connectors

E1. Labeling Systems

E2. Labels

E3. Pre-Printed & Write-On Markers

E4. Permanent Identification

E5. Lockout/Tagout & Safety Solutions

F. Index

A. System Overview

Solid Color Adhesive Warning Tape

B1. Cable Ties

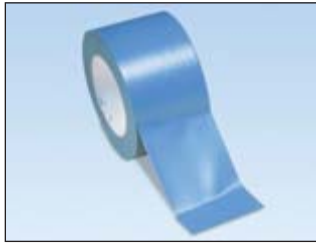

B2. Cable Accessories

B3. Stainless Steel Ties

C1. Wiring Duct

C2. Surface Raceway

C3. Abrasion Protection

C4. Cable Management

D1. Terminals

D2. Power Connectors

D3. Grounding Connectors

E1. Labeling Systems

E2. Labels

E3. Pre-Printed & Write-On Markers

E4. Permanent Identification

E5. Lockout/Tagout & Safety Solutions

F. Index

Material Chart

Material	Temperature Range	Features
Vinyl	-20°F to 175°F (-29°C to 79°C)	Indoor rated; color-coded for quick identification; can be used in place of paint; excellent adhesion properties when applied to a clean, dry surface.

Part Number	Color	Width		Length		Std. Pkg. Qty.	Std. Ctn. Qty.
		In.	mm	Ft.	m		
HT2-BLU	Blue	2.00	50.80	180.0	55.0	1	5
HT2-GRN	Green	2.00	50.80	180.0	55.0	1	5
HT2-ORN	Orange	2.00	50.80	180.0	55.0	1	5
HT2-RED	Red	2.00	50.80	180.0	55.0	1	5
HT2-WHT	White	2.00	50.80	180.0	55.0	1	5
HT2-YEL	Yellow	2.00	50.80	180.0	55.0	1	5

Photoluminescent Tapes – Thermal Transfer Printable



Normal Lighting

- Used to mark egress routes, fire alarms, and fire equipment that is clearly visible for up to ten hours after power is lost
- Absorb energy from ambient light and releases this energy in the form of a glow when power is lost
- Can be used in the *PANDUIT* thermal transfer desktop printers to create direction arrow tape, striped tape, or safety signs on demand
- *PANDUIT* Photoluminescent Tapes meet or exceed the following safety standard specification for photoluminescent safety markings including: ASTM E 2072-00, ASTM E 2073-00, ASTM E 2030-99, DIN67510-1, IMO Resolution A.752.18, ISO/CD 15370, DIN 67510, UL 924, ASTM 162, ASTM 648, ASTM 662, MIL-L-3891 B, NFPA 101 Life Safety Code, OSHA 1910.137



Black Light

Material Chart

Material	Print Method	Temperature Range	Features
Polyester, Photoluminescent (Y2)	Thermal Transfer (T)	-40°F to 230°F (-40°C to 110°C)	Indoor/outdoor rated; provides durability, high temperature resistance, and dimensional stability; does not stretch or easily tear; After power is lost, material emits glow that is clearly visible for up to ten hours.

Part Number	Part Description	Width		Length		Std. Pkg. Qty.	Std. Ctn. Qty.
		In.	mm	Ft.	m		
Pre-Printed							
PT2S-ARW	Photoluminescent, polyester tape, black arrow.	2.00	50.80	30.00	9.14	1	4
PT2S-BLK	Photoluminescent, polyester tape, black stripe.	2.00	50.80	30.00	9.14	1	4
PT2S-RED	Photoluminescent, polyester tape, red stripe.	2.00	50.80	30.00	9.14	1	4

Blank

T200X000Y2T	Photoluminescent, polyester tape.	2.00	50.80	15.00	4.5	1	4
T400X000Y2T	Photoluminescent, polyester tape.	4.00	101.60	15.0	4.5	1	4

Order number of rolls required.

Labels roll mounted on 3.00" cores; when using the TDP43MY thermal transfer desktop printer and 3.00" cores, the roll stand (TDP43M-RS) is required.



PT2S-ARW



PT2S-BLK



PT2S-RED

Underground Hazard Tape



Material Chart

Material	Print Method	Temperature Range	Features
Polyethylene (HTU, HTB)	Pre-Printed	-30°F to 200°F (-34°C to 93°C)	Indoor/outdoor rated; designed for direct burial; highly visible legend is protected from abrasion and chemicals; resistant to UV light, chemical atmosphere, and abrasion; will not biodegrade.
Detectible Laminated Aluminum (HTDU)	Pre-Printed	-30°F to 220°F (-34°C to 104°C)	Indoor/outdoor rated; aluminum embedded material is designed for direct burial; highly visible legend is protected from abrasion and chemicals; resistant to UV light, chemical atmosphere, and abrasion; will not biodegrade.

Part Number	Legend	Color (Legend/Background)	Height		Length		Std. Pkg. Qty.
			In.	mm	Ft.	m	
Laminated Detectable Aluminum							
HTDU2B-W	CAUTION WATER LINE BURIED BELOW	Black/Blue	2.00	50.80	1000.00	305.00	1
HTDU2O-FO	CAUTION FIBER OPTIC CABLE BURIED BELOW	Black/Orange					1
HTDU2O-T	CAUTION TELEPHONE LINE BURIED BELOW	Black/Orange					1
HTDU2R-E	CAUTION ELECTRIC LINE BURIED BELOW	Black/Red					1
HTDU3O-FO	CAUTION FIBER OPTIC CABLE BURIED BELOW	Black/Orange	3.00	76.00	1000.00	305.00	1
HTDU3O-T	CAUTION TELEPHONE LINE BURIED BELOW	Black/Orange					1
HTDU3R-E	CAUTION ELECTRIC LINE BURIED BELOW	Black/Red					1
HTDU6O-FO	CAUTION FIBER OPTIC CABLE BURIED BELOW	Black/Orange	6.00	152.00	1000.00	305.00	1
HTDU6O-T	CAUTION TELEPHONE LINE BURIED BELOW	Black/Orange					1
HTDU6R-E	CAUTION ELECTRIC LINE BURIED BELOW	Black/Red					1
Polyethylene							
HTU3G-T-M	CAUTION TELEPHONE LINE BURIED BELOW	Black/Green	3.00	76.00	1000.00	305.00	1
HTU3O-FO-M	CAUTION BURIED FIBER OPTIC CABLE	Black/Orange					1
HTU3O-T-M	CAUTION TELEPHONE LINE BURIED BELOW	Black/Orange					1
HTU3R-E-M	CAUTION ELECTRIC LINE BURIED BELOW	Black/Red					1
HTU3Y-E-M	CAUTION ELECTRIC LINE BURIED BELOW	Black/Yellow	6.00	152.00	1000.00	305.00	1
HTU6R-E	CAUTION ELECTRIC LINE BURIED BELOW	Black/Red					1
HTU6O-FO	CAUTION BURIED FIBER OPTIC CABLE	Black/Orange					1
HTU6O-T	CAUTION TELEPHONE LINE BURIED BELOW	Black/Orange					1
HTU6O-TV	CAUTION CABLE TV LINE BURIED BELOW	Black/Orange					1
HTU6Y-E	CAUTION ELECTRIC LINE BURIED BELOW	Black/Yellow					1
HTU6Y-G	CAUTION GAS LINE BURIED BELOW	Black/Yellow					1

A. System Overview

B1. Cable Ties

B2. Cable Accessories

B3. Stainless Steel Ties

C1. Wiring Duct

C2. Surface Raceway

C3. Abrasion Protection

C4. Cable Management

D1. Terminals

D2. Power Connectors

D3. Grounding Connectors

E1. Labeling Systems

E2. Labels

E3. Pre-Printed & Write-On Markers

E4. Permanent Identification

E5. Lockout/Tagout & Safety Solutions

F. Index

A.
System
Overview

Barricade Tapes

B1.
Cable Ties



B2.
Cable
Accessories

B3.
Stainless
Steel Ties

Part Number	Legend	Color (Legend/ Background)	Height		Length		Std. Pkg. Qty.
			In.	mm	Ft.	m	
HTB3-C-M	CAUTION	Black/Yellow	3.00	76.20	1000.00	305.00	1
HTB3-DNE-M	CAUTION DO NOT ENTER	Black/Yellow	3.00	76.00	1000.00	305.00	1
HTB3-HV-M	CAUTION HIGH VOLTAGE	Black/Yellow	3.00	76.00	1000.00	305.00	1

C1.
Wiring
Duct

Vinyl Letters and Numbers

C2.
Surface
Raceway



C3.
Abrasion
Protection

C4.
Cable
Management

Material Chart

Material	Print Method	Temperature Range	Features
Vinyl (PVL)	Pre-Printed	-50°F to 225°F (-46°C to 107°C)	Indoor/outdoor rated; heavy duty material for flat applications and safety and facility identification; resistant to UV light, chemical atmosphere, and abrasion.

D1.
Terminals

D2.
Power
Connectors

D3.
Grounding
Connectors

E1.
Labeling
Systems

E2.
Labels

E3.
Pre-Printed
& Write-On
Markers

E4.
Permanent
Identification

E5.
Lockout/
Tagout/
& Safety
Solutions

F.
Index

Part Number	Legend	Legend Height		Height		Width		Color (Legend/ Background)	Markers Per Card	Std. Pkg. Card(s)
		In.	mm	In.	mm	In.	mm			
PVL100BY-0-Y	0	1.00	25.40	1.50	38.10	.88	22.35	Black/Yellow	10	25
PVL100BY-1-Y thru PVL100BY-9-Y	1 thru 9									25
PVL100BY-A-Y thru PVL100BY-Z-Y	A thru Z									25
PVL100BY-DSH-Y	—									25
PVL200BY-0-Y	0									2.00
PVL200BY-1-Y thru PVL200BY-9-Y	1 thru 9	25								
PVL200BY-A-Y thru PVL200BY-Z-Y	A thru Z	25								
PVL200BY-DSH-Y	—	25								

Vinyl Cloth Letters and Numbers



Material Chart

Material	Print Method	Temperature Range	Features
Vinyl Cloth, (PCL,PCLCP)	Pre-Printed	-50°F to 170°F (-46°C to 77°C)	Indoor/outdoor rated; thin conformable material with repositionable adhesive allows label to be removed and reused or used in temporary applications; provides durability, high temperature resistance, and dimensional stability for rough or textured surfaces.

Part Number	Legend	Legend Height		Height		Width		Color (Legend/Background)	Markers Per Card	Std. Pkg. Card(s)	Std. Ctn. Card(s)
		In.	mm	In.	mm	In.	mm				
PCL037-0	0									25	100
PCL037-1 thru PCL037-9	1 thru 9									25	100
PCL037-0-9	0 thru 9									25	100
PCL037-A thru PCL037-Z	A thru Z	.38	9.65	.75	19.05	.34	8.64	Black/Yellow	78	25	100
PCL037-A-Z	A thru Z									25	100
PCLCP037-A-Z	A thru Z									1	4
PCLCP037-0-9	0 thru 9									1	4
PCL062-0	0									25	100
PCL062-1 thru PCL062-9	1 thru 9									25	100
PCL062-0-9	0 thru 9									1	4
PCL062-A thru PCL062-Z	A thru Z	.63	16.00	.75	19.05	.56	14.22	Black/Yellow	32	25	100
PCL062-A-Z	A thru Z									25	100
PCLCP062-0-9	1 thru 5 6 thru 0									1	4
PCLCP062-A-Z	A thru Z									1	4
PCL062-DSH	—									25	100
PCL100-0	0									25	100
PCL100-1 thru PCL100-9	1 thru 9									25	100
PCL100-0-9	0 thru 9									25	100
PCL100-A thru PCL100-Z	A thru Z	1.00	25.40	1.50	38.10	.88	22.35	Black/Yellow	10	25	100
PCL100-A-J	A thru J									25	100
PCL100-K-T	K thru T									25	100
PCL100-U-Z	U thru Z									25	100
PCLCP100-0-9	1 thru 5 6 thru 0									1	4
PCLCP100-A-Z	A thru Z									1	4
PCL100-DSH	—									25	100
PCL200-0	0									25	100
PCL200-1 thru PCL200-9	1 thru 9									25	100
PCL200-0-9	0 thru 9									25	100
PCL200-A thru PCL200-Z	A thru Z	2.00	50.80	2.25	57.15	.88	22.35	Black/Yellow	10	25	100
PCL200-A-J	A thru J									25	100
PCL200-K-T	K thru T									25	100
PCL200-U-Z	UK thru TZ									25	100
PCLCP200-0-9	1 thru 5 6 thru 0									1	4
PCLCP200-A-Z	A thru Z									1	4
PCL200-DSH	—									25	100

Table continues on page E5.36.

A. System Overview

B1. Cable Ties

B2. Cable Accessories

B3. Stainless Steel Ties

C1. Wiring Duct

C2. Surface Raceway

C3. Abrasion Protection

C4. Cable Management

D1. Terminals

D2. Power Connectors

D3. Grounding Connectors

E1. Labeling Systems

E2. Labels

E3. Pre-Printed & Write-On Markers

E4. Permanent Identification

E5. Lockout/Tagout & Safety Solutions

F. Index

A.
System
Overview

Vinyl Cloth Letters and Numbers (continued)

B1.
Cable Ties

B2.
Cable
Accessories

B3.
Stainless
Steel Ties

C1.
Wiring
Duct

Part Number	Legend	Legend Height		Height		Width		Color (Legend/Background)	Markers Per Card	Std. Pkg. Card(s)	Std. Ctn. Card(s)
		In.	mm	In.	mm	In.	mm				
PCL300-0	0	3.00	76.20	3.50	88.90	1.50	38.10	Black/Yellow	6	25	100
PCL300-1 thru PCL300-9	1 thru 9									25	100
PCL300-A thru PCL300-Z	A thru Z									25	100
PCLCP300-0-9	1 thru 5 6 thru 0									1	4
PCLCP300-A-Z	A thru Z									1	4
PCL300-DSH	—									25	100

C2.
Surface
Raceway

Reflective Letters and Numbers

C3.
Abrasion
Protection

C4.
Cable
Management



Material Chart

Material	Print Method	Temperature Range	Features
Reflective Vinyl, (PRL)	Pre-Printed	-30°F to 200°F (-34°C to 93°C)	Indoor/outdoor rated; heavy duty reflective material for flat applications and safety and facility identification; resistant to UV light, chemical atmosphere, and abrasion.

D1.
Terminals

D2.
Power
Connectors

D3.
Grounding
Connectors

E1.
Labeling
Systems

E2.
Labels

E3.
Pre-Printed
& Write-On
Markers

E4.
Permanent
Identification

E5.
Lockout/
Tagout
& Safety
Solutions

F.
Index

Part Number	Legend	Legend Height		Height		Width		Color (Legend/Background)	Markers Per Pkg.	Std. Pkg. Qty.	Std. Ctn. Qty.
		In.	mm	In.	mm	In.	mm				
PRL100BY-0 thru PRL100BY-9	0 thru 9	1.00	25.40	1.63	41.40	1.00	25.40	Black/Yellow	25	1	4
PRL100BY-A thru PRL100BY-Z	A thru Z								25	1	4
PRL100BY-DSH	—								25	1	4
PRL100BY-18KIT	0 thru 9, A thru D, L, P, R, S								900	1	—
PRL100BY-36KIT	0 thru 9, D, L, P, R, S, —, Blank								950	1	—
PRL100BY-BLNK	BLANK								25	1	4
PRL150YB-0 thru PRL150YB-9	0 thru 9	1.50	38.10	1.88	47.75	1.38	35.05	Yellow/Black	25	1	4
PRL150YB-A thru PRL150YB-Z	A thru Z								25	1	4
PRL150YB-DSH	—								25	1	4
PRL250YB-0 thru PRL250YB-9	0 thru 9	2.50	63.50	2.88	73.15	1.75	44.45	Yellow/Black	25	1	4
PRL250YB-A thru PRL250YB-Z	A thru Z								25	1	4
PRL250YB-DSH	—								25	1	4

Sign Panels – Blank Space for Custom Messages

Indoor/Outdoor Sub-Surface Printed Adhesive Polyester (Type PPS)

- High quality signs for use indoors and outdoors
- Excellent resistance to UV light, chemical atmosphere, and abrasion
- Excellent life and adhesion properties
- Printed graphics are protected by clear polyester laminate







Indoor/Outdoor Rigid Polyethylene (Type PRS)

- Rugged signs for indoors and outdoors
- Abrasion resistant
- Used where adhesives will not work

- Can be used with *PANDUIT* Thermal Transfer Desktop Printers and *EASY-MARK™* Labeling Software to create your own custom signs
- Print your own legend on clear polyester tape with the TDP43MY Thermal Transfer Desktop Printer and adhere label to adhesive or non-adhesive sign panel
- Can also be used with *PANDUIT* Die Cut Letter and Numbers

Material Chart

Material	Print Method	Temperature Range	Features
Polyester (PPS)	Pre-Printed	-40°F to 275°F (-40°C to 135°C)	Indoor/outdoor rated; laminated label material protects legend from abrasion and chemicals; resistant to UV light, chemical atmosphere, and abrasion; excellent life and adhesion properties.
Rigid Polyethylene (PRS)		-105°F to 250°F (-76°C to 121°C)	Indoor/outdoor rated; high quality, rugged material resistant to abrasion; use where adhesives will not work.

Part Number	Symbol	Header	Width		Height		Std. Pkg. Qty.	Std. Ctn. Qty.
			In.	mm	In.	mm		
PPS0710BWHT		BLANK	10.00	254.00	7.00	177.80	1	25
PPS1014BWHT			14.00	355.60	10.00	254.00	1	25
PPS1420BWHT			20.00	508.00	14.00	355.60	1	25
PRS0710BWHT			10.00	254.00	7.00	177.80	1	10
PRS1014BWHT			14.00	355.60	10.00	254.00	1	10
PRS1420BWHT			20.00	508.00	14.00	355.60	1	10
PPS0710BYEL		BLANK	10.00	254.00	7.00	177.80	1	25
PPS1014BYEL			14.00	355.60	10.00	254.00	1	25
PPS1420BYEL			20.00	508.00	14.00	355.60	1	25
PRS0710BYEL			10.00	254.00	7.00	177.80	1	10
PRS1014BYEL			14.00	355.60	10.00	254.00	1	10
PRS1420BYEL			20.00	508.00	14.00	355.60	1	10
PPS0710BYEL		CAUTION	10.00	254.00	7.00	177.80	1	25
PPS1014BYEL			14.00	355.60	10.00	254.00	1	25
PPS1420BYEL			20.00	508.00	14.00	355.60	1	25
PRS0710C442			10.00	254.00	7.00	177.80	1	25
PPS1014C442			14.00	355.60	10.00	254.00	1	25
PPS1420C442			20.00	508.00	14.00	355.60	1	25
PRS0710C442		DANGER	10.00	254.00	7.00	177.80	1	10
PPS1014C442			14.00	355.60	10.00	254.00	1	10
PPS1420C442			20.00	508.00	14.00	355.60	1	10
PRS0710D440			10.00	254.00	7.00	177.80	1	25
PPS1014D440			14.00	355.60	10.00	254.00	1	25
PPS1420D440			20.00	508.00	14.00	355.60	1	25
PRS0710D440		NOTICE	10.00	254.00	7.00	177.80	1	10
PPS1014D440			14.00	355.60	10.00	254.00	1	10
PPS1420D440			20.00	508.00	14.00	355.60	1	10
PRS0710N443			10.00	254.00	7.00	177.80	1	25
PPS1014N443			14.00	355.60	10.00	254.00	1	25
PPS1420N443			20.00	508.00	14.00	355.60	1	25
PRS0710N443		NOTICE	10.00	254.00	7.00	177.80	1	10
PPS1014N443			14.00	355.60	10.00	254.00	1	10
PPS1420N443			20.00	508.00	14.00	355.60	1	10

Order number of Standard Packages required

A.
System
Overview

B1.
Cable Ties

B2.
Cable
Accessories

B3.
Stainless
Steel Ties

C1.
Wiring
Duct

C2.
Surface
Raceway

C3.
Abrasion
Protection

C4.
Cable
Management

D1.
Terminals

D2.
Power
Connectors

D3.
Grounding
Connectors

E1.
Labeling
Systems

E2.
Labels

E3.
Pre-Printed
& Write-On
Markers

E4.
Permanent
Identification

E5.
Lockout/
Tagout
& Safety
Solutions

F.
Index

A. System Overview



Thermal Transfer Printable Arc Flash Labels

B1. Cable Ties

- Provide employees with the highest degree of safety through proper identification and communication
- Clearly visible and recognizable hazard information to communicate arc flash hazards present

- Labels are constructed of durable polyester designed to withstand UV exposure, outdoor use, water, abrasion
- Custom Arc Flash Hazard Labels can be printed using *PANDUIT* labeling software and desktop thermal transfer printers

B2. Cable Accessories

B3. Stainless Steel Ties



C400X600YX1

C1. Wiring Duct



C400X600YZ1

C2. Surface Raceway

C3. Abrasion Protection



T400X000YX1

C4. Cable Management

D1. Terminals

D2. Power Connectors

D3. Grounding Connectors



Laser Printable Adhesive Signs

- Signs can be printed with a standard laser printer
- Indoor polyolefin pressure sensitive signs with square corners on stay flat liner

- Signs are 8.50" x 11.00" (215.90mm x 279.40mm) in size
- 25 signs per package

E1. Labeling Systems



SEZ-1CLL



SEZ-1DLL

E2. Labels



SEZ-1NLL



SEZ-1WLL

E3. Pre-Printed & Write-On Markers

E4. Permanent Identification

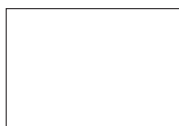

SEZ-1WHLL



SEZ-1YLL

E5. Lockout/Tagout & Safety Solutions

F. Index

Part Number	Part Description	Std. Pkg. Qty.	Std. Ctn. Qty.
Custom – Die-Cut			
C400X600YX1	4.00" x 6.00" (101.60mm x 152.40mm), polyester arc flash label, orange header, 100 labels per roll.	1	4
C400X600YZ1	4.00" x 6.00" (101.60mm x 152.40mm), polyester arc flash label, red/white danger header, 100 labels per roll.	1	4
Custom – Continuous Tape			
T400X000YX1	4.00" x 50.0' (101.60mm x 15.24m), polyester arc flash tape, orange header.	1	4

Part Number	Legend	Color (Legend/Background)	Width		Height		Signs Per Pkg.	Std. Pkg. Qty.	Std. Ctn. Qty.
			In.	mm	In.	mm			
SEZ-1CLL	CAUTION	Black/Yellow	8.50	216.00	11.00	279.00	25	1	5
SEZ-1DLL	DANGER	Red and Black/White	8.50	216.00	11.00	279.00	25	1	5
SEZ-1NLL	NOTICE	Blue/White	8.50	216.00	11.00	279.00	25	1	5
SEZ-1WLL	WARNING	Black/Orange	8.50	216.00	11.00	279.00	25	1	5
SEZ-1WHLL	BLANK	White	8.50	216.00	11.00	279.00	25	1	5
SEZ-1YLL	BLANK	Yellow	8.50	216.00	11.00	279.00	25	1	5

Self-Laminating Adhesive Sign Carriers



Material Chart

Material	Print Method	Temperature Range	Features
Rigid Vinyl	Pre-Printed	-40°F to 150°F (-40°C to 66°C)	Indoor/outdoor rated; rigid material accepts ink; resistant to UV light, chemical atmosphere, and abrasion; excellent for applications where adhesives will not work.

Part Number	Height				Carriers Per Pkg.	Std. Pkg. Qty.	Std. Ctn. Qty.
	In.	mm	In.	mm			

Adhesive

SEZ-SNC4	7.00	178.00	6.00	152.00	5	1	10
SEZ-SNC2	10.50	267.00	7.00	178.00	5	1	10
SEZ-SNC3	12.00	305.00	6.00	152.00	5	1	10
SEZ-SNC1	12.00	305.00	9.50	241.00	5	1	10

Non-Adhesive

SEZ-RSC1	7.00	178.00	6.00	152.00	5	1	10
SEZ-RSC2	10.50	267.00	7.00	178.00	5	1	10
SEZ-RSC3	12.00	305.00	9.50	241.00	5	1	10
SEZ-RSC4	12.00	305.00	6.00	152.00	5	1	10

Self-Laminating Cable Marker Holders for Large Cables or Cable Bundles



Material Chart

Material	Print Method	Temperature Range	Features
Rigid Vinyl, Self-Laminating	Pre-Printed	0°F to 176°F (-18°C to 80°C)	Indoor/outdoor rated; high quality, rugged material resistant to abrasion; legend is protected by overlaminates; use where adhesives will not work.

Part Number	Color	Width		Height		Tags Per Pkg.	Std. Pkg. Qty.	Std. Ctn. Qty.
		In.	mm	In.	mm			
SLCT-IG	Gray	3.00	76.20	1.31	33.30	25	1	4
SLCT-OR	Orange	3.00	76.20	1.31	33.30	25	1	4
SLCT-WH	White	3.00	76.20	1.31	33.30	25	1	4
SLCT-YL	Yellow	3.00	76.20	1.31	33.30	25	1	4
SLCT-3	White	4.00	101.60	.50	12.70	25	1	4
SLCT-3OR	Orange	4.00	101.60	.50	12.70	25	1	4
SLCT-3YL	Yellow	4.00	101.60	.50	12.70	25	1	4

Attach with PANDUIT Intermediate or Standard cross section cable ties.

Component Labels for Dot Matrix Printers Supplied on 8.5" x 11" Sheets

C200X100YJD	White, polyester label.	2.00	50.80	1.00	25.40	—	1000	5000
-------------	-------------------------	------	-------	------	-------	---	------	------

Component Labels for Laser/Ink Jet Printers Supplied on 8.5" x 11" Sheets

C200X100YJJ	White, polyester label.	2.00	50.80	1.00	25.40	—	1000	5000
-------------	-------------------------	------	-------	------	-------	---	------	------

Component Labels for Thermal Transfer Desktop Printers Supplied on Rolls

C200X100YJT	White, polyester label.	2.00	50.80	1.00	25.40	—	1000	5000
-------------	-------------------------	------	-------	------	-------	---	------	------

Component Cassettes for PANTHER™ LS8E Hand-Held Thermal Transfer Printer

C200X100YJC	White, polyester label, 200/cassette.	2.00	50.80	1.00	25.40	—	1	10
-------------	---------------------------------------	------	-------	------	-------	---	---	----

A.
System
Overview

B1.
Cable
Ties

B2.
Cable
Accessories

B3.
Stainless
Steel Ties

C1.
Wiring
Duct

C2.
Surface
Raceway

C3.
Abrasion
Protection

C4.
Cable
Management

D1.
Terminals

D2.
Power
Connectors

D3.
Grounding
Connectors

E1.
Labeling
Systems

E2.
Labels

E3.
Pre-Printed
& Write-On
Markers

E4.
Permanent
Identification

E5.
Lockout/
Tagout/
& Safety
Solutions

F.
Index

A.
System
Overview

Self-Laminating Fiber Optic Cable Marker Tags

B1.
Cable Ties

Material Chart



Material	Print Method	Temperature Range	Features
Rigid Vinyl, Self-Laminating	Pre-Printed	0°F to 176°F (-18°C to 80°C)	Indoor/outdoor rated; high quality, rugged material resistant to abrasion; legend is protected by overlamine; use where adhesives will not work.

B2.
Cable
Accessories

B3.
Stainless
Steel Ties

C1.
Wiring
Duct

Part Number	Legend	Color (Legend/Background)	Width		Height		Tags Per Pkg.	Std. Pkg. Qty.	Std. Ctn. Qty.
			In.	mm	In.	mm			
PST-FO	CAUTION FIBER OPTIC CABLE TYPE _____ COUNT _____	Black/Yellow	3.50	89.00	2.00	51.00	5	1	40
PST-FOBLNK	BLANK	Yellow	3.50	89.00	2.00	51.00	5	1	40

C2.
Surface
Raceway

Also available in Spanish and Portuguese. To order add part number suffix -E for Spanish or -P for Portuguese. Order number of packages required in multiples of Std. Pkg. Qty.

C3.
Abrasion
Protection

C4.
Cable
Management

D1.
Terminals

Ground Warning Tags

D2.
Power
Connectors

Material Chart



Material	Print Method	Temperature Range	Features
Rigid Polyethylene	Pre-Printed	-30°F to 250°F (-34°C to 121°C)	Indoor/outdoor rated; high quality, rugged material resistant to abrasion; use where adhesives will not work.

D3.
Grounding
Connectors

E1.
Labeling
Systems

Part Number	Legend	Color (Legend/Background)	Width		Height		Tags Per Pkg.	Std. Pkg. Qty.	Std. Ctn. Qty.
			In.	mm	In.	mm			
PT-BGND	NETWORK BUILDING GROUND	Green/Yellow	2.75	70.00	1.38	35.00	100	1	5
PT-GND	WARNING GROUND WIRE DO NOT REMOVE	Black/Yellow	2.75	70.00	1.38	35.00	100	1	5
PT-TGND	WARNING TELEPHONE CO. REPAIR SERVICE	Black/Yellow	2.75	70.00	1.38	35.00	100	1	5

E2.
Labels

Attach with *PANDUIT* Intermediate or Standard cross section cable ties.

E3.
Pre-Printed
& Write-On
Markers

E4.
Permanent
Identification

E5.
Lockout/
Tagout/
& Safety
Solutions

F.
Index

PANDUIT Corp. Generic Lock Order Form

One Form per Generic Lock Option
Fax orders to PANDUIT Corp., Attn: Customer Service (708) 570-3570
Generic Locks are Non-Returnable

Date: _____ PANDUIT Sales Rep: _____
 From: _____ Distributor: _____
 Telephone #: _____
 End User: _____

 Telephone#/Fax#: _____ Distributor Contact: _____
 Account #: _____ Telephone#/Fax#: _____
 Account #: _____

Generic Padlock Options

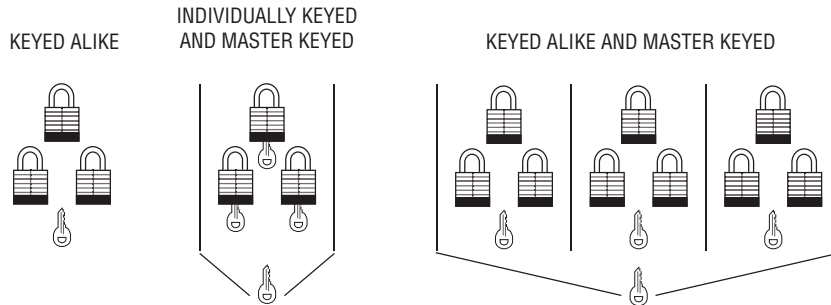

Generic Lock Part Number	Description	Qty Min. 12/Lock Series	Notes (Colors, Key Numbers, Set Description)
--------------------------	-------------	-------------------------	--

PSL-3 Laminated Steel Padlocks: (Select from red, yellow, blue, black, green or white bumper colors)

GPSL-3KA	Keyed Alike Padlock – 3/4" Shackle		
GPSL-3LSKA	Keyed Alike Padlock – 2" Shackle		
GPSL-3MK	Master Keyed Padlock – 3/4" Shackle		
GPSL-3LSMK	Master Keyed Padlock – 2" Shackle		
GPSL-3MKEY	Master Key for a PSL-3 Master Keyed Padlock		
GPSL-3KAMK	Keyed Alike and Master Keyed Padlock – 3/4" Shackle		
GPSL-3LSKAMK	Keyed Alike and Master Keyed Padlock – 2" Shackle		

PSL-4 Safety Lockout Padlocks: (Select from red, yellow, blue, black, green, orange or teal body colors)

GPSL-4KA	Keyed Alike Padlock		
GPSL-4LBKA	Keyed Alike Padlock – Long Body		
GPSL-4MK	Master Keyed Padlock		
GPSL-4BMK	Master Keyed Padlock – Long Body		
GPSL-4MKEY	Master Key for a PSL-4 Master Keyed Padlock		
GPSL-4KAMK	Keyed Alike and Master Keyed Padlock		
GPSL-4LBKAMK	Keyed Alike and Master Keyed Padlock – Long Body		

PSL-11 Coated Aluminum Padlocks: (Select from red, yellow, blue, black, green or orange body colors)

GPSL-11KA	Keyed Alike Padlock – 1" Shackle		
GPSL-11LKSA	Keyed Alike Padlock – 3" Shackle		
GPSL-11MK	Master Keyed Padlock – 1" Shackle		
GPSL-11LSMK	Master Keyed Padlock – 3" Shackle		
GPSL-11MKEY	Master Key for a PSL-11 Master Keyed Padlock		
GPSL-11KAMK	Keyed Alike and Master Keyed Padlock – 1" Shackle		
GPSL-11-LSKAMK	Keyed Alike and Master Keyed Padlock – 3" Shackle		

For Pricing and Lead Time Information, Contact PANDUIT Customer Service at 800-777-3300

A.
System
Overview

B1.
Cable Ties

B2.
Cable
Accessories

B3.
Stainless
Steel Ties

C1.
Wiring
Duct

C2.
Surface
Raceway

C3.
Abrasion
Protection

C4.
Cable
Management

D1.
Terminals

D2.
Power
Connectors

D3.
Grounding
Connectors

E1.
Labeling
Systems

E2.
Labels

E3.
Pre-Printed
& Write-On
Markers

E4.
Permanent
Identification

E5.
Lockout/
Tagout
& Safety
Solutions

F.
Index

PANDUIT Corp. Generic PVT Vinyl Tag Order Form

One Form per Generic Tag Option

Fax orders to PANDUIT Corp., Attn: Customer Service (708) 570-3570

Generic Tags are Non-Returnable

Date: _____ PANDUIT Sales Rep: _____
 From: _____ Distributor: _____
 Telephone #: _____
 End User: _____

 Telephone#/Fax#: _____ Telephone#/Fax#: _____
 Account #: _____ Account #: _____

Select the Generic Vinyl Tag Part Number and Quantity:

Number of Sides Printed	DANGER Black on White	CAUTION Black on Yellow	NOTICE Black on White	"No Header" Black on White	"No Header" Black on Yellow	"No Header" Black on Red	"No Header" Black on Green
1	GPVT-RBW1	GPVT-BY1	GPVT-BBW1	GPVT-W1-1	GPVT-Y1-1	GPVT-R1-1	GPVT-G1-1
2	GPVT-RBW2	GPVT-BY2	GPVT-BBW2	GPVT-W1-2	GPVT-Y1-2	GPVT-R1-2	GPVT-G1-2

Quantity In Packs (min. of 4 packs, 25 tags and ties/pack): _____ Part Number: _____

Use this space to create a rough sketch of your tag.
 Please indicate colors and legend. Please print.
 Attach an additional page or customer sketch if needed.

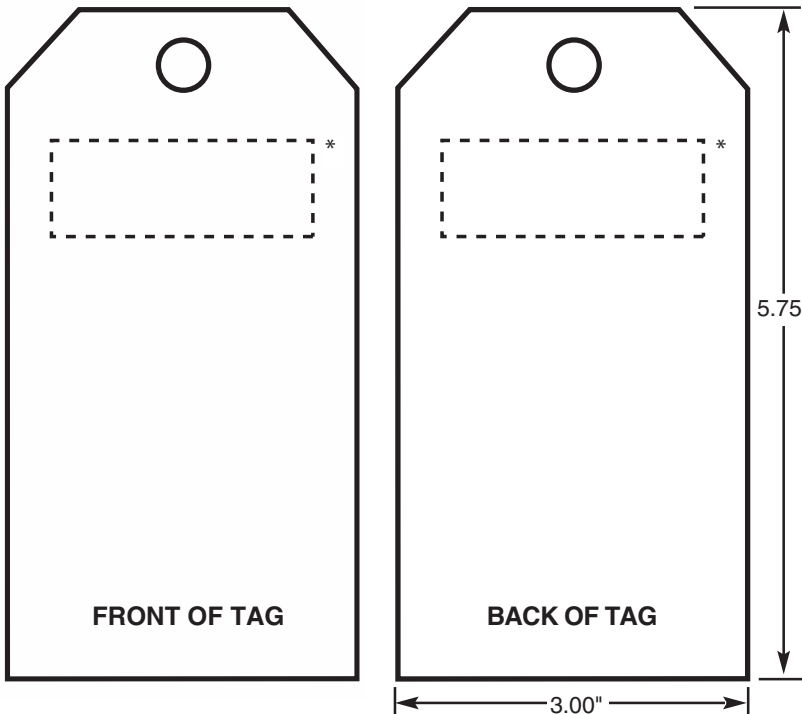

Check Applicable Order Requirements:

Pictogram (type _____)
Logo Required (camera ready artwork must accompany the order form)

Character Height (legend will be formatted to fit the size of the tag unless otherwise specified)

Logo Required _____
 (PANDUIT reserves the right to assign artwork approval when necessary)

*Normal position of header. Hole size = .375" with grommet.

One PANDUIT tie is included per tag.

For Pricing and Lead Time Information, Contact PANDUIT Customer Service at 800-777-3300

PANDUIT Corp. Generic Adhesive PPS Safety Sign Order Form

One Form per Generic Sign Option

Fax orders to PANDUIT Corp., Attn: Customer Service (708) 570-3570





Generic Signs are Non-Returnable

Date: _____ PANDUIT Sales Rep: _____
 From: _____ Distributor: _____
 Telephone #: _____
 End User: _____

 Telephone#/Fax#: _____ Telephone#/Fax#: _____
 Account #: _____ Account #: _____

Generic PPS Sign Options

Select the Generic Polyester Sign Part Number and Quantity

Size	 Black on White	 Black on Yellow	 Black on White	 Black on White	 Black on Orange	"No Header" Black on Orange	"No Header" Black on White	"No Header" Black on Yellow	"No Header" Red on White
3" x 5"	GPPS0305D	GPPS0305C	GPPS0305N	GPPS0305SF	GPPS0305W	GPPS0305B-BO	GPPS0305B-BW	GPPS0305B-BY	GPPS0305B-RW
7" x 10"	GPPS0710D	GPPS0710C	GPPS0710N	GPPS0710SF	GPPS0710W	GPPS0710B-BO	GPPS0710B-BW	GPPS0710B-BY	GPPS0710B-RW
10" x 14"	GPPS1014D	GPPS1014C	GPPS1014N	GPPS1014SF	GPPS1014W	GPPS1014B-BO	GPPS1014B-BW	GPPS1014B-BY	GPPS1014B-RW

Quantity Per Legend Per Size (Minimum of 10): _____ Part Number: _____

Print Legend in the Format Required:

Include Logos and/or Pictograms

Check Applicable Order Requirements

_____ Pictogram (type _____)
 _____ Logo Required (camera ready artwork must accompany order form)
 _____ Character Height (legend will be formatted to fit the size of the sign unless otherwise specified): _____

ARTWORK APPROVAL (PANDUIT reserves the right to assign artwork approval when necessary)

Notes: _____

For Pricing and Lead Time Information, Contact PANDUIT Customer Service at 800-777-3300

A. System Overview

B1. Cable Ties

B2. Cable Accessories

B3. Stainless Steel Ties

C1. Wiring Duct

C2. Surface Raceway

C3. Abrasion Protection

C4. Cable Management

D1. Terminals

D2. Power Connectors

D3. Grounding Connectors

E1. Labeling Systems

E2. Labels

E3. Pre-Printed & Write-On Markers

E4. Permanent Identification

E5. Lockout/Tagout & Safety Solutions

F. Index

A. System Overview
B1. Cable Ties
B2. Cable Accessories
B3. Stainless Steel Ties
C1. Wiring Duct
C2. Surface Raceway
C3. Abrasion Protection
C4. Cable Management
D1. Terminals
D2. Power Connectors
D3. Grounding Connectors
E1. Labeling Systems
E2. Labels
E3. Pre-Printed & Write-On Markers
E4. Permanent Identification
E5. Lockout/Tagout & Safety Solutions
F. Index

PANDUIT Corp. Generic Semi-Rigid PRS Safety Sign Order Form

One Form per Generic Sign Option
Fax orders to PANDUIT Corp., Attn: Customer Service (708) 570-3570
Generic Signs are Non-Returnable

Date: _____ PANDUIT Sales Rep: _____
 From: _____ Distributor: _____
 Telephone #: _____
 End User: _____

 Telephone#/Fax#: _____ Telephone#/Fax#: _____
 Account #: _____ Account #: _____

Generic PRS Sign Options

Select the Generic Semi-Rigid GMPE1 Polyethylene Sign Part Number and Quantity

	DANGER	CAUTION	NOTICE	SAFETY FIRST	WARNING	"No Header"	"No Header"	"No Header"	"No Header"
Size	Black on White	Black on Yellow	Black on White	Black on White	Black on Orange	Black on Orange	Black on White	Black on Yellow	Red on White
7" x 10"	GPRS0710D	GPRS0710C	GPRS0710N	GPRS0710SF	GPRS0710W	GPRS0710B-BO	GPRS0710B-BW	GPRS0710B-BY	GPRS0710B-RW
10" x 14"	GPRS1014D	GPRS1014C	GPRS1014N	GPRS1014SF	GPRS1014W	GPRS1014B-BO	GPRS1014B-BW	GPRS1014B-BY	GPRS1014B-RW
14" x 20"	GPRS1420D	GPRS1420C	GPRS1420N	GPRS1420SF	GPRS1420W	GPRS1420B-BO	GPRS1420B-BW	GPRS1420B-BY	GPRS1420B-RW

Quantity Per Legend Per Size (Minimum of 10): _____ Part Number: _____

Print Legend in the Format Required:
 Include Logos and/or Pictograms



Each sign will have (1) .1875" hole in each corner and .375" radius corners.

Check Applicable Order Requirements

_____ Pictogram (type _____)
 _____ Logo Required (camera ready artwork must accompany order form)
 _____ Character Height (legend will be formatted to fit the size of the sign unless otherwise specified): _____

ARTWORK APPROVAL (PANDUIT reserves the right to assign artwork approval when necessary)

Notes: _____

For Pricing and Lead Time Information, Contact PANDUIT Customer Service at 800-777-3300

PANDUIT Corp. Generic Conduit and Voltage Marker Order Form

One Form per Generic Marker Option
Fax orders to PANDUIT Corp., Attn: Customer Service (708) 570-3570
Generic Markers are Non-Returnable

Date: _____
 From: _____
 Telephone #: _____
 End User: _____

 Telephone#/Fax#: _____
 Account #: _____

PANDUIT Sales Rep: _____
 Distributor: _____

 Distributor Contact: _____
 Telephone#/Fax#: _____
 Account #: _____

Generic Conduit and Voltage Marker Options

Pressure Sensitive Adhesive GMV1 Vinyl Conduit and Voltage Markers

LEGEND

LEGEND	LEGEND
LEGEND	LEGEND

STYLE A

Marker size: 2.25" x 9"
 1 marker per card
 Character height: 1.75"

STYLE B

Marker size: 1.125" x 4.5"
 1 marker per card
 Character height: .75"



STYLE C

Marker size: .50" x 2.25" – 18 marker per card
 Character height: .3125"

Minimum Order Quantity: 10 cards per legend per size and in multiples of 5 cards

Part Desired ✓	Quantity of Cards	Part Number	Legend Color	Backgrnd Color	Style	Markers/ Card
		GPCV-AOY	BLACK	ORANGE	A	1
		GPCV-BOY	BLACK	ORANGE	B	4
		GPCV-COY	BLACK	ORANGE	C	18
		GPCV-AYY	BLACK	YELLOW	A	1
		GPCV-BYY	BLACK	YELLOW	B	4
		GPCV-CYY	BLACK	YELLOW	C	18

Print Legend Required

Legend to fit on one line. Max. 17 characters including spaces.

*Note: In Style B and C, if you want several different legends on a card, draw the lines to signify label division on the legend area. Write in the different legends needed.

Semi-Rigid Snap-On GMPET Polyester Conduit and Voltage Markers



- Protected graphics
- Six reversible legends per marker
- Character height: Size M – .50"
Size R – .75"

Minimum Order Quantity: 10 markers per legend per size

Part Desired ✓	Quantity of Markers	Part Number	Legend Color	Backgrnd Color	Style	Length of Marker	Conduit O.D. Range (In.)
		GPCV-ROY	BLACK	ORANGE	R	8"	.75" - 2.25"
		GPCV-MOY	BLACK	ORANGE	M	14"	2.50" - 6.00"
		GPCV-RYY	BLACK	YELLOW	R	8"	.75" - 2.25"
		GPCV-MYY	BLACK	YELLOW	M	14"	2.50" - 6.00"

Print Legend Required

Legend to fit on one line. Max. 19 characters including spaces.

For Pricing and Lead Time Information, Contact PANDUIT Customer Service at 800-777-3300

A. System Overview

B1. Cable Ties

B2. Cable Accessories

B3. Stainless Steel Ties

C1. Wiring Duct

C2. Surface Raceway

C3. Abrasion Protection

C4. Cable Management

D1. Terminals

D2. Power Connectors

D3. Grounding Connectors

E1. Labeling Systems

E2. Labels

E3. Pre-Printed & Write-On Markers

E4. Permanent Identification

E5. Lockout/Tagout & Safety Solutions

F. Index

PANDUIT Corp. Generic Utility Tapes Order Form

One Form per Generic Utility Tape Option

Fax orders to PANDUIT Corp., Attn: Customer Service (708) 570-3570

Generic Utility Tapes are Non-Returnable

Date: _____ PANDUIT Sales Rep: _____
 From: _____ Distributor: _____
 Telephone #: _____
 End User: _____

 Telephone#/Fax#: _____ Telephone#/Fax#: _____
 Account #: _____ Account #: _____

Generic Utility Tape Options

Part Number	Material	Width	Length	Use	Min. Order Qty.	Order Increments
GHTB3	Polyethylene	3.0" (76mm)	1,000' (305m)	Barricade	36	36
GHTU3	Polyethylene	3.0" (76mm)	1,000' (305m)	Underground	36	36
GHTU6	Polyethylene	6.0" (152mm)	1,000' (305m)	Underground	16	16
GHTDU3	Polyethylene Encased Aluminum	3.0" (76mm)	1,000' (305m)	Underground Detectable	8	8
GHTDU6	Polyethylene Encased Aluminum	6.0" (152mm)	1,000' (305m)	Underground Detectable	8	8

ALL LEGENDS ARE BLACK MAXIMUM OF TWO LINES OF TEXT ROLLS ARE ON 3 INCH CORE

Part Number: _____ **Quantity:** _____

Color: _____ (select from Blue, Green, Orange, Red or Yellow)



Sketch Legend and/or Artwork Below:

Comments: _____

For Pricing and Lead Time Information, Contact PANDUIT Customer Service at 800-777-3300

Wire Size Selection Guide

To use this guide place your wire or cable in the appropriate circle to determine wire, outside diameter.

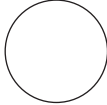
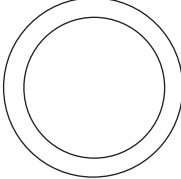
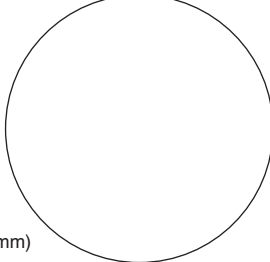
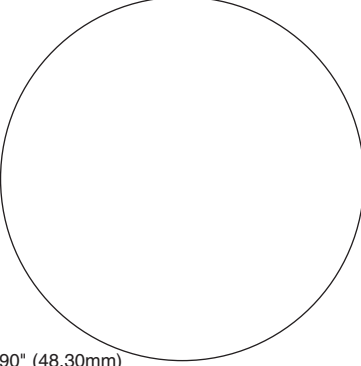
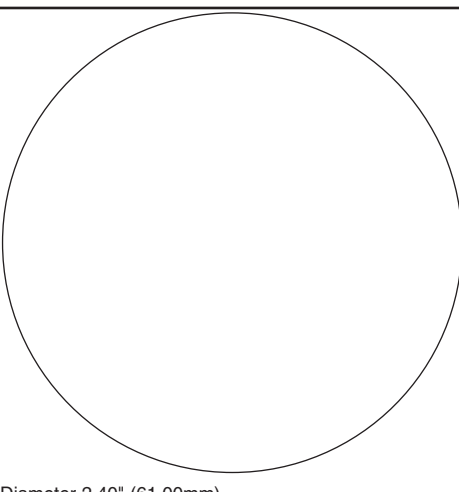
Diameter .10" (2.50mm)	
Diameter .20" (5.10mm)	
Diameter .28" (7.10mm)	
Diameter .54" (13.70mm)	
Diameter .94" (23.90mm)	
Diameter 1.40" (35.50mm)	
Diameter 1.90" (48.30mm)	
Diameter 2.40" (61.00mm)	

The charts below indicate the approximate cable outside diameter or various electrical and communication cables.

Electrical Cables

Size	Approximate Wire Outside Diameter In. (mm)			
	TF	THW	TW	TFN/THHN/THWN
18 AWG	.11 (2.80)	.11 (2.80)	.11 (2.80)	.09 (2.30)
16 AWG	.12 (3.00)	.12 (3.00)	.12 (3.00)	.10 (2.50)
14 AWG	.13 (3.30)	.16 (4.10)	.16 (4.10)	.10 (2.50)
12 AWG	.15 (3.80)	.18 (4.60)	.18 (4.60)	.12 (3.00)
10 AWG	.17 (4.30)	.20 (5.10)	.20 (5.10)	.15 (3.80)
8 AWG	.24 (6.10)	.28 (7.10)	.28 (7.10)	.22 (5.60)
6 AWG	.32 (8.10)	.32 (8.10)	.32 (8.10)	.26 (6.60)
4 AWG	.37 (9.40)	.37 (9.40)	.37 (9.40)	.33 (8.40)
3 AWG	.40 (10.20)	.40 (10.20)	.40 (10.20)	.36 (9.10)
2 AWG	.43 (10.90)	.43 (10.90)	.43 (10.90)	.39 (9.90)
1AWG	.51 (12.90)	.51 (12.90)	.51 (12.90)	.45 (11.40)
1/0	.55 (14.00)	.55 (14.00)	.55 (14.00)	.49 (12.40)
2/0	.59 (15.00)	.59 (15.00)	.59 (15.00)	.54 (13.70)
3/0	.65 (16.50)	.65 (16.50)	.65 (16.50)	.59 (15.00)
4/0	.70 (17.80)	.70 (17.80)	.70 (17.80)	.65 (16.50)
250 MCM	.79 (20.10)	.79 (20.10)	.79 (20.10)	.72 (18.30)
300 MCM	.84 (21.30)	.84 (21.30)	.84 (21.30)	.77 (19.60)
350 MCM	.89 (22.60)	.89 (22.60)	.89 (22.60)	.82 (20.80)
400 MCM	.94 (23.90)	.94 (23.90)	.94 (23.90)	.87 (22.10)
500 MCM	1.03 (26.20)	1.03 (26.20)	1.03 (26.20)	.95 (24.10)
600 MCM	1.14 (29.00)	1.14 (29.00)	1.14 (29.00)	1.06 (26.90)
700 MCM	1.21 (30.70)	1.21 (30.70)	1.21 (30.70)	1.13 (28.70)
750 MCM	1.25 (31.80)	1.25 (31.80)	1.25 (31.80)	1.16 (29.50)
800 MCM	1.28 (32.50)	1.28 (32.50)	1.28 (32.50)	1.20 (30.50)
900 MCM	1.34 (34.00)	1.34 (34.00)	1.34 (34.00)	1.26 (32.00)
1000 MCM	1.40 (35.60)	1.40 (35.60)	1.40 (35.60)	1.32 (33.50)
1250 MCM	1.58 (40.10)	1.58 (40.10)	1.58 (40.10)	
1500 MCM	1.70 (43.20)	1.70 (43.20)	1.70 (43.20)	
1750 MCM	1.82 (46.20)	1.82 (46.20)	1.82 (46.20)	
2000 MCM	1.92 (48.80)	1.92 (48.80)	1.92 (48.80)	

Category 3, Category 5/5e/6 and 6a Cable

Size	Category 3		Category 5/5e/6		
	Voice Grade 24 AWG UTP	Data Grade 24 AWG UTP	Data Grade 24 AWG STP	Data Grade 22 AWG UTP	Data Grade 22 AWG STP
2-Pair	.12 (3.00)				
3-Pair	.15 (3.80)				
4-Pair	.19 (4.80)	.22 (5.60)	.25 (6.30)	.23 (5.80)	.29 (7.40)
25-Pair		.42 (10.70)	.51 (12.90)	.54 (13.70)	.63 (16.00)
50-Pair	.46 (11.70)	.66 (16.80)			
100-Pair	.63 (16.00)	.96 (24.40)			
300-Pair	1.07 (27.20)				

Coaxial Cable







Size	Coax
RG58/u	.19 (4.80)
RG59/u	.24 (6.10)
RG62A/u	.24 (6.10)
RG6/u	.27 (6.80)
RG11/u	.40 (10.20)

Fiber Optic Distribution (62.5/125)

Size	Non-Plenum	Plenum
6 Strand	.26 (6.60)	.18 (4.60)
8 Strand	.27 (6.90)	.18 (4.60)
12 Strand	.28 (7.10)	.21 (5.30)
18 Strand	.49 (12.4)	.47 (11.90)
24 Strand	.54 (13.70)	.52 (13.2)
36 Strand	.54 (13.70)	.52 (13.2)
48 Strand	.59 (15.00)	.56 (14.2)
72 Strand	.72 (18.30)	.71 (18.0)

A. System Overview

Selection Guide by Wire/Cable Size

	Label Type	Width In.	Wire/Cable Size																												
			22 AWG	20 AWG	18 AWG	16 AWG	14 AWG	12 AWG	10 AWG	Cat. 5/5e/6	8 AWG	6 AWG	4 AWG	2 AWG	1 AWG	1/0 AWG	2/0 AWG	3/0 AWG	4/0 AWG	250 MCM	500 MCM										
B1. Cable Ties		.50				S050X075*																									
B2. Cable Accessories										S050X125*																					
B3. Stainless Steel Ties						S100X075*				S100X125*				S100X150*				S100X225*				S100X400*				S100X650*					
C1. Wiring Duct		.25				N025X075*				N025X125*				N025X150*																	
C2. Surface Raceway						N050X075*				N050X125*				N050X150*						N050X175*											
C3. Abrasion Protection						N100X075*				N100X125*				N100X150*				N100X175*													
C4. Cable Management		.25				N025X150*				N025X175*																					
						N050X150*				N050X175*																					
						N100X150*				N100X175*																					
D1. Terminals		.50				H050X025*																									
D2. Power Connectors						H050X034*				H050X044*				H050X064*						H050X084*											
D3. Grounding Connectors						H075X025*				H075X034*				H075X044*																	
E1. Labeling Systems		1.00				H050X025*				H050X034*				H050X044*				H050X064*						H050X084*				H100X165*			
E2. Labels						H150X025*				H150X034*				H150X044*																	
E3. Pre-Printed & Write-On Markers						H175X025*				H175X034*				H175X044*				H175X084*													
E4. Permanent Identification		2.00				H200X025*				H200X034*				H200X044*				H200X064*						H200X084*				H200X165*			
E5. Lockout/Tagout & Safety Solutions																															
F. Index																															

*Represents material type, color, and print method.

PANDUIT® ELECTRICAL SOLUTIONS

Part Number	Page Number
A	
A1C12-A-C8	B2.32
A1C25-A-C8	B2.32
A1C38-A-C8	B2.32
A1C50-A-C8	B2.32
A2C12-A-C8	B2.33
A2C25-A-C8	B2.33
A2C38-A-C8	B2.33
A2C50-A-C8	B2.33
ABM100-A-C	B2.2
ABM100-A-C15	B2.2
ABM100-AT-C	B2.2
ABM100-AT-C0	B2.2
ABM100-S6-C	B2.3
ABM100-S6-C69	B2.3
ABM112-A-C	B2.2
ABM112-AT-C	B2.2
ABM112-AT-C0	B2.2
ABM112-S6-C	B2.3
ABM112-S6-C69	B2.3
ABM1M-A-C	B2.2
ABM1M-AT-C	B2.2
ABM2S-A-C	B2.2
ABM2S-A-C14	B2.2
ABM2S-A-C15	B2.2
ABM2S-AT-C	B2.2
ABM2S-AT-C0	B2.2
ABM2S-S6-D	B2.3
ABM3H-A-L	B2.2
ABM3H-AT-L	B2.2
ABM3H-S6-T	B2.3
ABM4H-A-L	B2.2
ABM4H-AT-L	B2.2
ABM4H-S6-T	B2.3
ABMM-A-C	B2.2
ABMM-A-D	B2.3
ABMM-AT-C	B2.2
ABMM-AT-C0	B2.2
ABMM-D	B2.3
ABMQS-A-Q	B2.4
ABMQS-A-Q20	B2.4
ABMQS-AT-Q	B2.4
ABMQS-AT-Q0	B2.4
ABMQS-S6-C	B2.4
ABMQS-S6-C0	B2.4
ABMT-A-C	B2.10, C4.11
ABMT-A-C20	B2.10, C4.11
ABMT-S6-C	B2.10, C4.11
ABMT-S6-C20	B2.10, C4.11
ABMT-S6-C60	B2.10, C4.11
ABMT-S6-C69	B2.10, C4.11
ACC19-A-C	B2.31
ACC19-A-C20	B2.31
ACC19-AT-C	B2.31
ACC19-AT-C0	B2.31
ACC38-A-C	B2.31
ACC38-A-C20	B2.31
ACC38-AT-C	B2.31
ACC38-AT-C0	B2.31
ACC62-A-C	B2.31
ACC62-A-C20	B2.31
ACC62-AT-C	B2.31
ACC62-AT-C0	B2.31
ADCC31-AT-C10	B2.36
AJC12-A-C	B2.32
AJC19-A-C	B2.32
AJC25-A-C	B2.32
AJC31-A-C	B2.32
AJC38-A-C	B2.32
AM2-C	B2.11
AMC25-AT-C10	B2.36
ARC.68-A-Q	B2.30
ARC.68-A-Q14	B2.30
ARC.68-S6-Q	B2.30
ARC.68-S6-Q14	B2.30
ASMS-A-X	B2.7
AST10-5-C100	B2.28
AST15-5-C100	B2.28
AST20-5-C100	B2.28
AST25-5-C100	B2.28

Part Number	Page Number
B	
B2M2S-D	B1.52
B2M2S-D0	B1.52

Part Number	Page Number
B3M2S-TL	B1.52
B3M2S-TL0	B1.52
B4M2S-TL	B1.52
B4M2S-TL0	B1.52
BC1.5I-S8-M	B1.48
BC1.5I-S8-M0	B1.49
BC1M-S4-M	B1.48
BC1M-S4-M0	B1.49
BC2M-S4-M	B1.48
BC2M-S4-M0	B1.49
BC2S-S10-C	B1.48
BC2S-S10-C0	B1.49
BC3S-S10-D	B1.48
BC3S-S10-D0	B1.49
BC4LH-S25-L	B1.48
BC4LH-S25-L0	B1.49
BC4S-S10-C	B1.48
BC4S-S10-C0	B1.49
BC4S-S10-D30	B1.49
BEC38-A-L	B2.35
BEC38-A-L20	B2.35
BEC38-AT-L0	B2.35
BEC62-A-L	B2.35
BEC62-A-L20	B2.35
BEC62-AT-L0	B2.35
BEC75-A-L	B2.35
BEC75-A-L20	B2.35
BEC75-AT-L0	B2.35
BECP38H25-L	B2.35
BECP38H25-L20	B2.35
BECP75H25-L	B2.35
BECP75H25-L20	B2.35
BF1M-C	B1.52
BF1M-M0	B1.52
BF2M-C	B1.52
BF2M-M0	B1.52
BM1M-C	B1.52
BM1M-M0	B1.52
BM2M-C	B1.52
BM2M-M0	B1.52
BM2S-C	B1.52
BM2S-D0	B1.52
BM4S-C	B1.52
BM4S-D0	B1.52
BP2S-D0	B1.51
BPC1-X	D2.121
BPC1/0-X	D2.121
BPC2-L	D2.121
BPC2/0-X	D2.121
BPC250-X	D2.121
BPC3/0-X	D2.121
BPC300-X	D2.121
BPC350-X	D2.121
BPC4-L	D2.121
BPC4/0-X	D2.121
BPC400-X	D2.121
BPC500-X	D2.121
BPC6-L	D2.121
BPC600-6	D2.121
BPC750-6	D2.121
BR.5-E6-C	B2.48
BR.75-E6-C	B2.48
BR2-1.3-A-X	B2.48
BR2-1.3-X	B2.48
BR2-1.5-X	B2.48
BR2-4-X	B2.48
BR2-6-X	B2.48
BS10-L	D1.66
BS14-C	D1.66
BS18-C	D1.66
BS22-C	D1.66
BSH10-E	D1.68
BSH14-Q	D1.68
BSH18-Q	D1.68
BSM1-C	D1.69
BSM2-C	D1.69
BSM6-L	D1.69
BSMN1-3K	D1.139
BSMN2-3K	D1.139
BSMN6-2K	D1.139
BSMP1-3K	D1.139
BSMP2-3K	D1.139
BSMV1BX-CY	D1.68
BSMV2BX-C	D1.68
BSMV6X-L	D1.68
BSN10-2K	D1.130

Part Number	Page Number
C	
BSN10-L	D1.65
BSN14-3K	D1.130
BSN14-C	D1.65
BSN18-3K	D1.130
BSN18-C	D1.65
BSN22-C	D1.65
BSP14-3K	D1.130
BSP18-3K	D1.130
BSV10X-L	D1.65
BSV14X-C	D1.65
BSV18X-CY	D1.65
BT1.5I-C	B1.45
BT1.5I-C0	B1.46
BT1.5I-M30	B1.47
BT1.5I-M39	B1.47
BT1.5M-C	B1.45
BT1.5M-C0	B1.46
BT1.5M-M30	B1.47
BT1.5M-XMR	B1.118
BT1.5M-XMR0	B1.118
BT1.5M-XMR30	B1.118
BT1.5M-XMR69	B1.118
BT1HT	B3.26
BT1M-C	B1.45
BT1M-C0	B1.46
BT1M-C30	B1.47
BT1M-M39	B1.47
BT1M-XMR	B1.118
BT1M-XMR0	B1.118
BT1M-XMR30	B1.118
BT2I-C	B1.45
BT2I-C0	B1.46
BT2I-M30	B1.47
BT2LH-L	B1.45
BT2LH-L0	B1.46
BT2M-C	B1.45
BT2M-C0	B1.46
BT2M-M30	B1.47
BT2S-C	B1.45
BT2S-C0	B1.46
BT2S-M30	B1.47
BT2S-M39	B1.47
BT3I-C	B1.45
BT3I-C0	B1.46
BT3I-M30	B1.47
BT3LH-L	B1.45
BT3LH-L0	B1.46
BT3S-C	B1.45
BT3S-C0	B1.46
BT3S-M30	B1.47
BT3S-M39	B1.47
BT4I-C	B1.45
BT4I-C0	B1.46
BT4LH-L	B1.45
BT4LH-L0	B1.46
BT4LH-TL30	B1.47
BT4LH-TL39	B1.47
BT4M-C	B1.45
BT4M-C0	B1.46
BT4S-C	B1.45
BT4S-C0	B1.46
BT4S-M30	B1.47
BT4S-M39	B1.47
BT5LH-L	B1.45
BT5LH-L0	B1.46
BT6LH-L	B1.45
BT6LH-L0	B1.46
BT7LH-L	B1.45
BT7LH-L0	B1.46
BT8LH-L	B1.45
BT8LH-L0	B1.46
BT9LH-L	B1.45
BT9LH-L0	B1.46
BW1.5I-D	B1.50
BW2S-D	B1.50
BW2S-D0	B1.50
BW3S-D	B1.50
BW3S-D0	B1.50

Part Number	Page Number
C	
C-2001	D3.51
C-720	D1.87, D3.33
C025X025KBT	E2.16
C025X025KCT	E2.16
C025X025YJD	E2.24

A. System Overview
B1. Cable Ties
B2. Cable Accessories
B3. Stainless Steel Ties
C1. Wiring Duct
C2. Surface Raceway
C3. Abrasion Protection
C4. Cable Management
D1. Terminals
D2. Power Connectors
D3. Grounding Connectors
E1. Labeling Systems
E2. Labels
E3. Pre-Printed & Write-On Markers
E4. Permanent Identification
E5. Lockout/Tagout & Safety Solutions
F. Index

PANDUIT® ELECTRICAL SOLUTIONS

A. System Overview	Part Number	Page Number	Part Number	Page Number	Part Number	Page Number
B1. Cable Ties	C025X025YJT	E2.16	C200X050YJT	E2.17	CBR4I-M0	B1.59
	C038X038KBT	E2.16	C200X100FJJ	E2.5	CBR4LH-TL	B1.58
	C038X038KCT	E2.16	C200X100YJC	E1.8	CBR4LH-TL0	B1.59
	C038X038YJD	E2.24	C200X100YJD	E2.24	CBR4LH-TL30	B1.60
	C038X038YJJ	E2.5	C200X100YJJ	E2.5	CBR4S-M	B1.58
B2. Cable Accessories	C038X038YJT	E2.16	C200X100YJT	E2.17	CBR4S-M0	B1.59
	C038X038YLJ	E2.5	C200X100YLJ	E2.5	CBR4S-M30	B1.60
	C050X013KBT	E2.16	C200X100YMC	E1.8	CBR6LH-C	B1.58
	C050X013KCT	E2.16	C225X450FJJ	E2.5	CBR6LH-C0	B1.59
	C050X044CBD	E2.24	C2YL6	C1.56	CBR6LH-C30	B1.60
B3. Stainless Steel Ties	C050X044CBT	E2.16	C300X025KBT	E2.17	CC-720	D1.87, D3.33
	C050X044KBT	E2.16	C300X025KCT	E2.17	CCH100-S10-C	B2.40
	C050X044KCT	E2.16	C350X500FJJ	E2.5	CCH112-S10-C	B2.40
	C050X044YJD	E2.24	C400X100CBD	E2.24	CCH119-S10-C	B2.40
	C050X044YJJ	E2.5	C400X100CBT	E2.17	CCH12-S10-C	B2.40
C1. Wiring Duct	C050X044YJT	E2.16	C400X100YJD	E2.24	CCH125-S10-C	B2.40
	C060X020CBD	E2.24	C400X100YJJ	E2.5	CCH138-S10-C	B2.40
	C060X020CBT	E2.16	C400X100YJT	E2.17	CCH150-S10-C	B2.40
	C060X020KBT	E2.16	C400X200YJD	E2.24	CCH19-S10-C	B2.40
	C060X020KCT	E2.16	C400X200YJJ	E2.5	CCH25-S10-C	B2.40
C2. Surface Raceway	C060X020TJT	E2.16	C400X200YJT	E2.17	CCH31-S10-C	B2.40
	C060X020YJC	E1.8	C400X400YJD	E2.24	CCH38-S10-C	B2.40
	C060X020YJD	E2.24	C400X400YJJ	E2.5	CCH44-S10-C	B2.40
	C060X020YJJ	E2.5	C400X400YJT	E2.17	CCH50-S10-C	B2.40
	C060X020YJT	E2.16	C400X600PBT	E2.17	CCH56-S10-C	B2.40
C3. Abrasion Protection	C065X019KBT	E2.16	C400X600YJT	E2.17	CCH62-S10-C	B2.40
	C065X019KCT	E2.16	C400X600YX1	E5.23	CCH69-S10-C	B2.40
	C075X025CBD	E2.24	C400X600YZ1	E5.23	CCH75-S10-C	B2.40
	C075X025CBT	E2.16	C4YL6	C1.56	CCH81-S10-C	B2.40
	C075X025KBT	E2.16	C500X700FJJ	E2.5	CCH87-S10-C	B2.40
C4. Cable Management	C075X025KCT	E2.16	C850X1100YJJ	E2.5	CCMKIT1	C4.12
	C075X025YJD	E2.24	C850X1100YLJ	E2.5	CCMKIT2	C4.12
	C075X025YJJ	E2.5	CA-800EZ	D1.143	CCS12-S8-C	B2.40
	C075X025YJT	E2.16	CA10	D1.143	CCS19-S8-C	B2.40
	C075X025YLJ	E2.5	CA3IW-X	C2.82	CCS25-S10-C	B2.40
D1. Terminals	C080X020KBT	E2.16	CA5IW-X	C2.82	CCS25-S8-C	B2.40
	C080X020KCT	E2.16	CA9	D1.143	CCS31-S8-C	B2.40
	C080X020YJD	E2.24	CAMT	B3.14	CCS38-S8-C	B2.40
	C080X020YJJ	E2.5	CB125-14-QY	D2.145	CCS44-S8-C	B2.40
	C080X020YJT	E2.16	CB175-38-QY	D2.145	CCS50-S8-C	B2.40
D2. Power Connectors	C090X025KBT	E2.16	CB225-56-QY	D2.145	CD125-14-QY	D2.144
	C090X025KCT	E2.16	CB25-18-CY	D2.145	CD-2001-1	D3.38
	C100X019KBT	E2.16	CB300-38-QY	D2.145	CD-2001-1/0	D3.38
	C100X019KCT	E2.16	CB35-36-CY	D2.145	CD-2001-2	D3.38
	C100X025CBD	E2.24	CB400-38-3Y	D2.145	CD-2001-2/0	D3.38
D3. Grounding Connectors	C100X025CBT	E2.16	CB650-12-3Y	D2.145	CD-2001-250	D3.38
	C100X025KBT	E2.16	CB70-14-CY	D2.145	CD-2001-3/0	D3.38
	C100X025KCT	E2.16	CBA70-14-CY	D2.145	CD-2001-300	D3.38
	C100X025YJC	E1.8	CBLS18-C	B2.46	CD-2001-350	D3.38
	C100X025YJD	E2.24	CBLS25-C	B2.46	CD-2001-4	D3.38
E1. Labeling Systems	C100X025YJJ	E2.5	CBLS37-C	B2.46	CD-2001-4/0	D3.38
	C100X025YJT	E2.16	CBLS50-C	B2.46	CD-2001-400	D3.38
	C100X038KBT	E2.16	CBLS62-C	B2.46	CD-2001-500	D3.38
	C100X038KCT	E2.16	CBLS75-C	B2.46	CD-2001-6	D3.38
	C100X050CBC	E1.8	CBP100-C	B2.46	CD-2001-8	D3.38
E2. Labels	C100X050CBD	E2.24	CBP12-C	B2.46	CD-2001-BG	D3.38
	C100X050CBT	E2.16	CBP25-C	B2.46	CD-2001-C	D3.38
	C100X050YJC	E1.8	CBP31-C	B2.46	CD-2001-O	D3.38
	C100X050YJD	E2.24	CBP37-C	B2.46	CD225-56-QY	D2.144
	C100X050YJJ	E2.5	CBP50-C	B2.46	CD300-38-3Y	D2.144
E3. Pre-Printed & Write-On Markers	C100X050YJT	E2.16	CBP62-C	B2.46	CD400-38-3Y	D2.144
	C100X050YLJ	E2.5	CBP75-C	B2.46	CD650-12-3Y	D2.144
	C100X050YMC	E1.8	CBP87-C	B2.46	CD70-14-QY	D2.144
	C125X025KBT	E2.16	CBR1.5I-M	B1.58	CD-720-1	D1.87, D3.33
	C125X025KCT	E2.16	CBR1.5I-M0	B1.59	CD-720-2	D1.87, D3.33
E4. Permanent Identification	C150X025KBT	E2.16	CBR1.5I-M30	B1.60	CD-720-3	D1.87, D3.33
	C150X025KCT	E2.16	CBR1.5M-M	B1.58	CD-720-4	D1.87, D3.33
	C150X075YJC	E1.8	CBR1.5M-M0	B1.59	CD-720-5	D1.87, D3.33
	C150X075YJD	E2.24	CBR1M-M	B1.58	CD-720-6	D1.87, D3.33
	C150X075YJJ	E2.5	CBR1M-M0	B1.59	CD-720-7	D1.87, D3.33
E5. Lockout/Tagout & Safety Solutions	C150X075YJT	E2.16	CBR1M-M30	B1.60	CD-720PV8-2	D1.87, D3.33
	C160X020CBD	E2.24	CBR2HS-D	B1.58	CD-800-1	D1.145
	C160X020CBT	E2.17	CBR2HS-D0	B1.59	CD-800-10	D1.145
	C160X020KBT	E2.17	CBR2M-M	B1.58	CD-800-11	D1.145
	C160X020KCT	E2.17	CBR2M-M0	B1.59	CD-800-12	D1.145
F. Index	C160X020YJD	E2.24	CBR2S-M	B1.58	CD-800-13	D1.145
	C160X020YJJ	E2.5	CBR2S-M0	B1.59	CD-800-14	D1.145
	C160X020YJT	E2.17	CBR2S-M30	B1.60	CD-800-15	D1.145
	C200X025KBT	E2.17	CBR2S-M39	B1.60	CD-800-16	D1.145
	C200X025KCT	E2.17	CBR3I-M	B1.58	CD-800-17	D1.145

PANDUIT® ELECTRICAL SOLUTIONS

Part Number	Page Number	Part Number	Page Number	Part Number	Page Number
CD-800-5	D1.145	CDM-920-4/0	D3.46	CO125-14-QY	D2.146
CD-800-6	D1.145	CEFXIW-X	C2.81	CO225-56-QY	D2.146
CD-800-7	D1.145	CF10IW-X	C2.79	CO300-38-3Y	D2.146
CD-800-8	D1.145	CF382538F-Q	C3.12	CO35-36-QY	D2.146
CD-800-9	D1.145	CF3IW-E	C2.79	CO400-38-3Y	D2.146
CD-920-1	D3.46	CF502550F-Q	C3.12	CO650-12-3Y	D2.146
CD-920-1/0	D3.46	CF503850F-Q	C3.12	CO70-14-QY	D2.146
CD-920-2	D3.46	CF5IW-E	C2.79	CP-871	D1.144
CD-920-2/0	D3.46	CF752575F-Q	C3.12	CP106IW	C2.59
CD-920-250	D3.46	CF753875F-Q	C3.12	CP106IW-2G	C2.59
CD-920-3/0	D3.46	CFX10IW-X	C2.75, C2.80, C2.81	CPGIW	C2.59
CD-920-300	D3.46	CFX3IW-X	C2.80, C2.81	CPGIW-2G	C2.59
CD-920-350	D3.46	CFX5IW-X	C2.80, C2.81	CPH.75-S8-X	B2.48
CD-920-4	D3.46	CG-920	D3.51	CPL.75-S8-X	B2.48
CD-920-4/0	D3.46	CG-940	D3.51	CPM122S-C	B2.23
CD-920-400	D3.46	CG-980	D3.51	CPM87S-C	B2.23
CD-920-500	D3.46	CH105-A-C14	B2.37	CPNIW	C2.59
CD-920-500A	D3.46	CH105-S6-C14	B2.37	CPNIW-2G	C2.59
CD-920-6	D3.46	CLRCVR1-1	D3.8	CR2-M	B2.26
CD-920-600	D3.46	CLRCVR2-1	D3.8	CR4H-M	B2.26
CD-920-750	D3.46	CLRCVR3-1	D3.8	CR4H-M0	B2.26
CD-920-8	D3.46	CLRCVR5-1	D3.8	CRFC5IW-X	C2.79, C2.80
CD-920-BG	D3.46	CLRCVR6-1	D3.8	CRFX5IW-X	C2.81
CD-920-C	D3.46	CLT100F-C20	C3.11	CROS-M	B2.26
CD-920-D3	D3.46	CLT100F-C3	C3.11	CRS1-125-X	C4.9
CD-920-O	D3.46	CLT100N-C630	C3.12	CRS1-X	C4.9
CD-920H-2	D3.46	CLT125F-L20	C3.11	CRS4-125-X	C4.9
CD-920H-6	D3.46	CLT125F-L3	C3.11	CRS6-X	C4.9
CD-920H-8	D3.46	CLT125F-L4	C3.11	CS125-14-QY	D2.143
CD-930H-250	D3.46	CLT125N-L630	C3.12	CS175-38-QY	D2.143
CD-940-1000	D3.47	CLT150F-T20	C3.11	CS1LG6	C1.30
CD-940-1000A	D3.47	CLT150F-X20	C3.11	CS1WH6	C1.30
CD-940-750	D3.47	CLT150F-X3	C3.11	CS225-56-QY	D2.143
CD-940-750A	D3.47	CLT150F-X4	C3.11	CS25-18-CY	D2.143
CD-940-750X	D3.47	CLT150N-D630	C3.12	CS300-38-QY	D2.143
CD-940-800	D3.47	CLT188F-X20	C3.11	CS35-36-CY	D2.143
CD-940-800A	D3.47	CLT188F-X3	C3.11	CS400-38-3Y	D2.143
CD-940-DA	D3.47	CLT188F-X4	C3.11	CS650-12-3Y	D2.143
CD-940-N	D3.47	CLT188N-6C630	C3.12	CS70-14-CY	D2.143
CD-940H-1000	D3.47	CLT25F-C20	C3.11	CSA70-14-CY	D2.143
CD-940H-500	D3.47	CLT25F-C3	C3.11	CSC1LG6	C1.29
CD-940H-750	D3.47	CLT25N-C630	C3.12	CSC1WH6	C1.29
CD10-1	D1.143, D1.146	CLT35N-C630	C3.12	CSCS-M	B2.27
CD10-2	D1.143, D1.146	CLT38F-C20	C3.11	CSH-D0	B2.26
CD10-3	D1.143, D1.146	CLT38F-C3	C3.11	CSH-D20	B2.26
CD9-10A	D1.146	CLT38N-C630	C3.12	CSP1.5LG-Q	C1.30
CD9-10B	D1.146	CLT50F-C20	C3.11	CSP1LG-Q	C1.30
CD9-11A	D1.146	CLT50F-C3	C3.11	CSP2LG-Q	C1.30
CD9-11B	D1.146	CLT50N-C630	C3.12	CSP3LG-Q	C1.30
CD9-12A	D1.146	CLT75F-C20	C3.11	CSP4LG-Q	C1.30
CD9-13B	D1.146	CLT75F-C3	C3.11	CSPC1.5LG-Q	C1.29
CD9-14A	D1.146	CLT75N-C630	C3.12	CSPC1LG-Q	C1.29
CD9-15A	D1.146	CLTS100F-C	C3.12	CSPC2LG-Q	C1.29
CD9-16A	D1.146	CLTS100F-C3	C3.12	CSPC3LG-Q	C1.29
CD9-17B	D1.146	CLTS100N-C	C3.12	CSPC4LG-Q	C1.29
CD9-18B	D1.146	CLTS125F-L	C3.12	CST101	D3.34
CD9-1A	D1.146	CLTS125F-L3	C3.12	CST114-157	D3.34
CD9-1AD	D1.146	CLTS150F-D3	C3.12	CST115	D1.83, D3.34
CD9-1B	D1.146	CLTS25F-C	C3.12	CT-100	D1.83
CD9-2A	D1.146	CLTS25F-C3	C3.12	CT-1000	D1.86, D1.142
CD9-2AD	D1.146	CLTS25N-C	C3.12	CT-1002	D1.85
CD9-2B	D1.146	CLTS35N-C	C3.12	CT-1003	D1.85
CD9-3B	D1.146	CLTS38F-C	C3.12	CT-1004	D1.85
CD9-4A	D1.146	CLTS38F-C3	C3.12	CT-1005	D1.85
CD9-4B	D1.146	CLTS38N-C	C3.12	CT-1006	D1.85
CD9-5A	D1.146	CLTS50F-C	C3.12	CT-1014	D1.84
CD9-5B	D1.146	CLTS50F-C3	C3.12	CT-1015	D1.84
CD9-6B	D1.146	CLTS50N-C	C3.12	CT-1104	D1.85
CD9-7A	D1.146	CLTS75F-C	C3.12	CT-1123	D1.85
CD9-8B	D1.146	CLTS75F-C3	C3.12	CT-1525	D1.84
CD9-9C	D1.146	CLTS75N-C	C3.12	CT-1550	D1.84
CDCLP3	C1.5	CM4S-L2	B1.80	CT-1551	D1.84
CDCLP4	C1.5	CM4S-L8	B1.80	CT-1570	D1.84
CDLB3	C1.5	CMP-100-1	D2.123, D2.161, D3.21	CT-160	D1.83
CDLB4	C1.5	CMP-200-1	D2.123, D3.21	CT-1700	D1.84
CDM-2001-1	D3.38	CMP-300-1	D3.21	CT-1701	D1.84
CDM-2001-1/0	D3.38	CMP-300-4-1	D3.21	CT-200	D1.83
CDM-2001-2	D3.38	CMVDR1	C4.10	CT-2001	D3.36
CDM-2001-2/0	D3.38	CMVDR1S	C4.10	CT-2002	D3.37
CDM-2001-3/0	D3.38	CMVDR2	C4.10	CT-2500	D1.88
CDM-920-1	D3.46	CMVDR2S	C4.10	CT-2500/E	D1.88
CDM-920-1/0	D3.46	CMVDRC	C4.10	CT-2500BC	D1.88
CDM-920-2	D3.46	CMW-KIT	C4.8	CT-2500CASE	D1.88
CDM-920-2/0	D3.46	CMW2B	C4.9	CT-2500CHR	D1.88
CDM-920-250	D3.46	CMWB	C4.8	CT-2500CHR/E	D1.88
CDM-920-3/0	D3.46	CMWW	C4.8	CT-2525CH	D1.88

A. System Overview
B1. Cable Ties
B2. Cable Accessories
B3. Stainless Steel Ties
C1. Wiring Duct
C2. Surface Raceway
C3. Abrasion Protection
C4. Cable Management
D1. Terminals
D2. Power Connectors
D3. Grounding Connectors
E1. Labeling Systems
E2. Labels
E3. Pre-Printed & Write-On Markers
E4. Permanent Identification
E5. Lockout/Tagout & Safety Solutions
F. Index

A. System Overview	Part Number	Page Number	Part Number	Page Number	Part Number	Page Number
B1. Cable Ties	CT-2550CH	D1.88	D10-250M-L	D1.53	DMNF2-63FIB-3K	D1.133
	CT-2570CH	D1.88	D100H2	C1.26	DMNF2-63FIB-C	D1.57
	CT-260	D1.83	D14-145M-C	D1.55	DMNF2-63FIBX-2K	D1.134
	CT-2931	D3.39	D14-187-C	D1.49	DMNF2-63FIM-2K	D1.136
	CT-2940	D3.40	D14-188-C	D1.49	DMNF2-63FIM-C	D1.59
	CT-2981	D3.49	D14-250-C	D1.49	DMNF2-63FIMB-K	D1.136
	CT-300-1	D1.85	D14-250MB-C	D1.53	DMNF2-63FIMX-2K	D1.137
	CT-310	D1.85	D18-145M-C	D1.55	DMNF2-63M-3K	D1.137
	CT-400	D1.86	D18-187-C	D1.49	DMNF2-63M-C	D1.59
	CT-460	D1.86	D18-188-C	D1.49	DMNF2485FIBX-2K	D1.134
B2. Cable Accessories	CT-500CH	D1.86	D18-250-C	D1.49	DMNF2488FIBX-2K	D1.134
	CT-520CH	D1.86	D18-250MB-C	D1.53	DMNF6-63FI-L	D1.57
	CT-550CH	D1.86	D1H6	C1.26	DMNF6-63FIB-2K	D1.133
	CT-570CH	D1.86	D1X2LG6	C1.13	DMNF6-63M-2K	D1.137
	CT-600-A	D1.86	D1X3LG6	C1.13	DMNF6-63M-L	D1.59
	CT-720	D1.87, D3.33	D1X4LG6	C1.13	DMNFR1485FIB-KD	D1.134
	CT-720-3	D3.34	D2.5X3LG6	C1.13	DMNFR1488FIB-KD	D1.134
	CT-720-3CC	D3.34	D2H6	C1.26	DMNFR163FIB-KD	D1.134
	CT-720-7	D3.34	D2HWH6	C1.26	DMNFR2485FIB-KD	D1.134
	CT-720-7CC	D3.34	D2X2LG6	C1.13	DMNFR2488FIB-KD	D1.134
B3. Stainless Steel Ties	CT-8250HP	D3.45	D2X3LG6	C1.13	DMNFR263FIB-KD	D1.134
	CT-900HPH	D3.43	D2X4LG6	C1.13	DMNG1-485FB-3K	D1.132
	CT-900LPHPH	D3.45	D3H6	C1.26	DMNG1-488FB-3K	D1.132
	CT-901HP	D3.43	D3HWH6	C1.26	DMNG1-63FB-3K	D1.132
	CT-901RCH	D3.43	D3X2LG6	C1.13	DMNG1-63FL-3K	D1.133
	CT-901RFS	D3.43, D3.45	D3X3LG6	C1.13	DMNG2-485FB-3K	D1.132
	CT-930	D3.35	D3X4LG6	C1.13	DMNG2-488FB-3K	D1.132
	CT-930CH	D3.41	D4H6	C1.26	DMNG2-63FB-3K	D1.132
	CT-930LPCH	D3.44	D4HWH6	C1.26	DMNG2-63FL-3K	D1.133
	CT-940CH	D3.42	D4X2LG6	C1.13	DMPF1-285FIB-3K	D1.135
C1. Wiring Duct	CT-980	D3.48	D4X3LG6	C1.13	DMPF1-288FIB-3K	D1.135
	CT-980CH	D3.50	D4X4LG6	C1.13	DMPF1-485FIB-3K	D1.135
	CT-980LPCH	D3.50	D50H2	C1.26	DMPF1-488FIB-3K	D1.135
	CT-BC25	D3.51	D75H2	C1.26	DMPF1-63FIB-3K	D1.135
	CT-CHR25	D3.51	DB-C	C1.26	DMPF1-63FIM-2K	D1.136
	CT-NLBC25	D3.51	DC450-38-3Y	D2.145	DMPF1-63FIMB-K	D1.136
	CTAP2-2-X	D3.7	DC600-38-3Y	D2.145	DMPF2-488FIB-3K	D1.135
	CTAP2-4-Q	D3.7	DC800-12-3Y	D2.145	DMPF2-63FIB-3K	D1.135
	CTAP2/0-2-X	D3.7	DCEFXIW-X	C2.80, C2.81	DMPF2-63FIM-2K	D1.136
	CTAP2/0-2/0-X	D3.7	DCF10IW-X	C2.79	DMPF2-63FIMB-K	D1.136
C2. Surface Raceway	CTAP4-4-L	D3.7	DCF3IW-X	C2.79	DMPF2-63FIB-2K	D1.135
	CTAP4-6-L	D3.7	DCF5IW-X	C2.79	DMV1-37MB-3K	D1.139
	CTAP4-8-L	D3.7	DCT	C1.34	DMV1-485B-3K	D1.135
	CTAP4/0-2-X	D3.7	DCT-BLD	C1.34	DMV1-488B-3K	D1.135
	CTAP4/0-2/0-X	D3.7	DCT-RI	C1.34	DMV1-63B-3K	D1.135
	CTAP4/0-4/0-X	D3.7	DFCT	C1.34	DMV1-63MB-3K	D1.138
	CTAPF1-12-C	D3.6	DHC1.12X1.75-D0	B1.78	DMV1-63P-CY	D1.59
	CTAPF1/0-12-L	D3.6	DJS1LG6	C1.30	DMV2-37MB-3K	D1.139
	CTAPF10-16-C	D3.6	DJS1WH6	C1.30	DMV2-485B-3K	D1.135
	CTAPF2-12-C	D3.6	DM1-488-C	D1.58	DMV2-488B-3K	D1.135
C3. Abrasion Protection	CTAPF2/0-12-Q	D3.6	DM1-63-C	D1.58	DMV2-63B-3K	D1.135
	CTAPF3-12-C	D3.6	DM1-63M-C	D1.60	DMV2-63MB-3K	D1.138
	CTAPF3/0-12-Q	D3.6	DM2-488-C	D1.58	DMV2-63P-C	D1.59
	CTAPF4-12-C	D3.6	DM2-63-C	D1.58	DMV6-63-2K	D1.135
	CTAPF6-12-C	D3.6	DM2-63M-C	D1.60	DMV6-63-L	D1.58
	CTAPF8-12-C	D3.6	DM6-63-L	D1.58	DMV6-63M-2K	D1.138
	CW-12-Q	D2.118, D2.161	DM6-63M-L	D1.60	DNF10-250FI-L	D1.44, D1.45
	CW-14-L	D2.118, D2.161	DMNF1-283FIB-3K	D1.133	DNF10-250FIB-2K	D1.123
	CW-38-L	D2.118, D2.161	DMNF1-285-C	D1.58	DNF10-250FIB-L	D1.45
	CW-56-L	D2.118, D2.161	DMNF1-285FIB-3K	D1.133	DNF10-250FIMB-K	D1.128
CW-58-Q	D2.118, D2.161	DMNF1-285FIB-C	D1.57	DNF10-250FIMB-L	D1.44	
C4. Cable Management	CWD3LG6	C1.5	DMNF1-288-C	D1.58	DNF10-250M-2K	D1.129
	CWD3WH6	C1.5	DMNF1-288FIB-3K	D1.133	DNF10-250M-L	D1.52
	CWD4LG6	C1.5	DMNF1-288FIB-C	D1.57	DNF10250FIBC-2K	D1.123
	CWD4WH6	C1.5	DMNF1-63FIM-2K	D1.136	DNF14-110-C	D1.47
	CWF400	C4.8	DMNF1-488-C	D1.58	DNF14-111-C	D1.47
	CX125-14-QY	D2.142	DMNF1-488FIB-3K	D1.133	DNF14-187-C	D1.47
	CX125-56T-QY	D2.142	DMNF1-488FIB-C	D1.57	DNF14-187FIB-3K	D1.123
	CX225-38T-QY	D2.142	DMNF1-63-C	D1.58	DNF14-187FIB-C	D1.45
	CX225-56-QY	D2.142	DMNF1-63FIB-3K	D1.133	DNF14-188-C	D1.47
	CX225-56T-QY	D2.142	DMNF1-63FIB-C	D1.134	DNF14-188FIB-3K	D1.123
D1. Terminals	CX35-36-CY	D2.142	DMNF1-63FIM-2K	D1.136	DNF14-188FIB-C	D1.45
	CX35-36T-CY	D2.142	DMNF1-63FIM-C	D1.59	DNF14-205-C	D1.47
	CX400-12T-3Y	D2.142	DMNF1-63FIMB-K	D1.136	DNF14-205FIB-3K	D1.123
	CX400-38-3Y	D2.142	DMNF1-63FIMX-2K	D1.137	DNF14-205FIB-C	D1.45
	CX70-14-CY	D2.142	DMNF1-63M-3K	D1.137	DNF14-206-C	D1.47
	CX70-14T-CY	D2.142	DMNF1-63M-C	D1.59	DNF14-206FIB-3K	D1.123
	DMNF1485FIBX-2K	D1.134	DMNF1488FIBX-2K	D1.134	DNF14-206FIB-C	D1.45
	DMNF2-288-C	D1.58	DMNF2-485FIB-3K	D1.133	DNF14-250-C	D1.47
	DMNF2-488-C	D1.58	DMNF2-488FIB-3K	D1.133	DNF14-250FI-C	D1.45
	DMNF2-488FIB-C	D1.57	DMNF2-488-C	D1.58	DNF14-250FIB-3K	D1.123
D2. Power Connectors	DMNF2-488FIB-3K	D1.133	DMNF2-488-C	D1.58	DNF14-250FIB-C	D1.44, D1.45
	DMNF2-63FIB-3K	D1.133	DMNF2-488FIB-C	D1.57	DNF14-250FIM-2K	D1.128
	DMNF2-63FIM-2K	D1.136	DMNF2-488FIB-C	D1.57	DNF14-250FIM-C	D1.44
	DMNF2-63FIMB-K	D1.136	DMNF2-63-C	D1.58		
	DMNF2-63FIMX-2K	D1.137				
	DMNF2-63M-3K	D1.137				
	DMNF2-63M-C	D1.59				
	DMNF2-63MB-3K	D1.138				
	DMNF2-63P-C	D1.59				
	DMNF2-63P-CY	D1.59				
D3. Grounding Connectors	D-250A-C	D1.51				
	D1.5H6	C1.26				
	D1.5X2LG6	C1.13				
	D1.5X3LG6	C1.13				
	D1.5X4LG6	C1.13				
	D10-250-L	D1.49				
	D2.118	D2.161				
	D2.118	D2.161				
	D2.118	D2.161				
	D2.118	D2.161				
D4. Permanent Identification	D1.57	D1.58				
	D1.57	D1.58				
	D1.57	D1.58				
	D1.57	D1.58				
	D1.57	D1.58				
	D1.57	D1.58				
	D1.57	D1.58				
	D1.57	D1.58				
	D1.57	D1.58				
	D1.57	D1.58				
E1. Labeling Systems	D1.57	D1.58				
	D1.57	D1.58				
	D1.57	D1.58				
	D1.57	D1.58				
	D1.57	D1.58				
	D1.57	D1.58				
	D1.57	D1.58				
	D1.57	D1.58				
	D1.57	D1.58				
	D1.57	D1.58				
E2. Labels	D1.57	D1.58				
	D1.57	D1.58				
	D1.57	D1.58				
	D1.57	D1.58				
	D1.57	D1.58				
	D1.57	D1.58				
	D1.57	D1.58				
	D1.57	D1.58				
	D1.57	D1.58				
	D1.57	D1.58				
E3. Pre-Printed & Write-On Markers	D1.57	D1.58				
	D1.57	D1.58				
	D1.57	D1.58				
	D1.57	D1.58				
	D1.57	D1.58				
	D1.57	D1.58				
	D1.57	D1.58				
	D1.57	D1.58				
	D1.57	D1.58				
	D1.57	D1.58				
E4. Permanent Identification	D1.57	D1.58				
	D1.57	D1.58				
	D1.57	D1.58				
	D1.57	D1.58				
	D1.57	D1.58				
	D1.57	D1.58				
	D1.57	D1.58				
	D1.57	D1.58				
	D1.57	D1.58				
	D1.57	D1.58				
E5. Lockout/Tagout & Safety Solutions	D1.57	D1.58				
	D1.57	D1.58				
	D1.57	D1.58				
	D1.57	D1.58				
	D1.57	D1.58				
	D1.57	D1.58				
	D1.57	D1.58				
	D1.57	D1.58				
	D1.57	D1.58				
	D1.57	D1.58				
F. Index	D1.57	D1.58				
	D1.57	D1.58				
	D1.57	D1.5				

PANDUIT® ELECTRICAL SOLUTIONS

Part Number	Page Number
DNF14-250FIMB-L	D1.44
DNF14-250M-3K	D1.129
DNF14-250M-C	D1.52
DNF14205FIBX-2K	D1.124
DNF14206FIBX-2K	D1.124
DNF14250FIBX-2K	D1.124
DNF14250FIMX-2K	D1.128
DNF18-110-C	D1.47
DNF18-110FIB-3K	D1.123
DNF18-110FIB-C	D1.45
DNF18-111-C	D1.47
DNF18-111FIB-3K	D1.123
DNF18-111FIB-C	D1.45
DNF18-112FIB-3K	D1.123
DNF18-187-C	D1.47
DNF18-187FIB-3K	D1.123
DNF18-187FIB-C	D1.45
DNF18-188-C	D1.47
DNF18-188FIB-3K	D1.123
DNF18-188FIB-C	D1.45
DNF18-205-C	D1.47
DNF18-205FIB-3K	D1.123
DNF18-205FIB-C	D1.45
DNF18-206-C	D1.47
DNF18-206FIB-3K	D1.123
DNF18-206FIB-C	D1.45
DNF18-250-C	D1.47
DNF18-250FI-C	D1.45
DNF18-250FIB-3K	D1.123
DNF18-250FIB-C	D1.44, D1.45
DNF18-250FIM-2K	D1.128
DNF18-250FIM-C	D1.44
DNF18-250FIMB-K	D1.128
DNF18-250FIMB-L	D1.44
DNF18-250M-3K	D1.129
DNF18-250M-C	D1.52
DNF18205FIBX-2K	D1.124
DNF18206FIBX-2K	D1.124
DNF18250FIBX-2K	D1.124
DNF18250FIMX-2K	D1.128
DNFR14-205B-C	D1.50
DNFR14-205FIB-C	D1.49
DNFR14-206B-C	D1.50
DNFR14-206FIB-C	D1.49
DNFR14-250B-C	D1.50
DNFR14-250FIB-C	D1.49
DNFR14205FIB-KD	D1.124
DNFR14206FIB-KD	D1.124
DNFR14250FIB-KD	D1.124
DNFR18-205B-C	D1.50
DNFR18-205FIB-C	D1.49
DNFR18-206B-C	D1.50
DNFR18-206FIB-C	D1.49
DNFR18-250B-C	D1.50
DNFR18-250FIB-C	D1.49
DNFR18205FIB-KD	D1.124
DNFR18206FIB-KD	D1.124
DNFR18250FIB-KD	D1.124
DNG14-187FB-3K	D1.122
DNG14-187FB-C	D1.43
DNG14-188FB-3K	D1.122
DNG14-188FB-C	D1.43
DNG14-250FB-3K	D1.122
DNG14-250FB-C	D1.43
DNG14-250FL-3K	D1.123
DNG14-250FL-C	D1.44
DNG18-187FB-3K	D1.122
DNG18-187FB-C	D1.43
DNG18-188FB-3K	D1.122
DNG18-188FB-C	D1.43
DNG18-250FB-3K	D1.122
DNG18-250FB-C	D1.43
DNG18-250FL-3K	D1.123
DNG18-250FL-C	D1.44
DNH10-250FI-E	D1.47
DNH14-250FIB-Q	D1.47
DNH14-250FIM-Q	D1.47
DNH18-250FIB-Q	D1.47
DNH18-250FIM-Q	D1.47
DNT-100	C1.34
DPF10-250FI-L	D1.46
DPF10-250FIB-2K	D1.126
DPF10-250FIB-L	D1.46
DPF14-187FIB-3K	D1.126
DPF14-205FIB-3K	D1.126
DPF14-205FIB-C	D1.46

Part Number	Page Number
DPF14-206FIB-3K	D1.126
DPF14-206FIB-C	D1.46
DPF14-250FIB-3K	D1.126
DPF14-250FIB-C	D1.46
DPF14-250FIM-2K	D1.127
DPF14-250FIM-C	D1.46
DPF14-250FIMB-K	D1.127
DPF14-250FIMB-L	D1.46
DPF18-110FIB-3K	D1.126
DPF18-110FIB-C	D1.46
DPF18-111FIB-3K	D1.126
DPF18-111FIB-C	D1.46
DPF18-187FIB-3K	D1.126
DPF18-187FIB-C	D1.46
DPF18-188FIB-3K	D1.126
DPF18-205FIB-3K	D1.126
DPF18-205FIB-C	D1.46
DPF18-206FIB-3K	D1.126
DPF18-206FIB-C	D1.46
DPF18-250FIB-3K	D1.126
DPF18-250FIB-C	D1.46
DPF18-250FIM-2K	D1.127
DPF18-250FIM-C	D1.46
DPF18-250FIMB-K	D1.127
DPF18-250FIMB-L	D1.46
DR10-250-L	D1.50
DR14-205-C	D1.50
DR14-205B-C	D1.51
DR14-206-C	D1.50
DR14-206B-C	D1.51
DR14-250-C	D1.50
DR14-250B-C	D1.51
DR18-205-C	D1.50
DR18-205B-C	D1.51
DR18-206-C	D1.50
DR18-206B-C	D1.51
DR18-250-C	D1.50
DR18-250B-C	D1.51
DS1	C3.16
DS5	C3.16
DSF-NP	D1.144
DSF-RS	D1.144
DT14EH-L0	B1.53
DT15EH-L0	B1.53
DT28EH-C0	B1.53
DT44EH-C0	B1.53
DT4EH-L0	B1.53
DT8EH-Q0	B1.53
DTHEH-Q0	B1.53
DTHH-Q0	B1.53
DTKEH-O	B1.53
DTKH-O	B1.53
DTREH-LR0	B1.53
DTRH-LR0	B1.53
DV10-250-2K	D1.125
DV10-250-L	D1.48
DV10-250C-2K	D1.125
DV10-250M-2K	D1.129
DV10-250M-L	D1.52
DV14-145M-C	D1.55
DV14-145MB-3K	D1.130
DV14-187B-3K	D1.125
DV14-187B-C	D1.48
DV14-188B-3K	D1.125
DV14-188B-C	D1.48
DV14-205B-3K	D1.125
DV14-205B-C	D1.48
DV14-206B-3K	D1.125
DV14-206B-C	D1.48
DV14-250B-3K	D1.125
DV14-250B-C	D1.48
DV14-250MB-3K	D1.129
DV14-250MB-C	D1.52
DV14-250P-C	D1.51
DV18-145M-CY	D1.55
DV18-145MB-3K	D1.130
DV18-187B-3K	D1.125
DV18-187B-CY	D1.48
DV18-188B-3K	D1.125
DV18-188B-CY	D1.48
DV18-205B-3K	D1.125
DV18-205B-CY	D1.48
DV18-206B-3K	D1.125
DV18-206B-CY	D1.48
DV18-250B-3K	D1.125
DV18-250B-CY	D1.48
DV18-250MB-3K	D1.129

Part Number	Page Number
DV18-250MB-CY	D1.52
DV18-250P-CY	D1.51
DVF14-187-C	D1.48
DVF14-188-C	D1.48
DVF14-205-C	D1.48
DVF14-206-C	D1.48
DVF14-250-C	D1.48
DVF18-187-CY	D1.48
DVF18-188-CY	D1.48
DVF18-205-CY	D1.48
DVF18-206-CY	D1.48
DVF18-250-CY	D1.48

E	
E2X2YL6	C1.56
E4X4YL6	C1.56
ECF10IW-X	C2.79
ECF3IW-E	C2.79
ECF5IW-E	C2.79
ECFX10IW-X	C2.75, C2.80, C2.81
ECFX3IW-X	C2.80, C2.81
ECFX5IW-X	C2.80, C2.81
EDU20IW-X	C2.60
EEFXIW	C2.75
EGU20IW-X	C2.60
EMA-X	B2.8
EMS-A-C	B2.7
EMS-A-C0	B2.7
EMSK12-4-12-X0	B2.8
EMSK3-1-3-0	B2.8
EMSK3-1-X0	B2.8
ER.5-E4-X	B2.47
ER1.25-E4-X	B2.47
ERU20IW-X	C2.60
ETU20IW-X	C2.60

F	
F5X.5LG6	C1.11
F5X1LG6	C1.11
F.75X.75LG6	C1.11, C1.13
F.75X1.5LG6	C1.11
F1.5X1.5LG6	C1.11
F1.5X1LG6	C1.11
F1.5X2LG6	C1.11
F1.5X3LG6	C1.11
F1.5X4LG6	C1.11
F14PN-L	C1.59
F14PWN-L	C1.59
F1X1.5LG6	C1.11
F1X1LG6	C1.11
F1X2LG6	C1.11
F1X3LG6	C1.11
F1X4LG6	C1.11
F2.5X3LG6	C1.11
F2PCLB12	C1.61
F2PCLB58	C1.61
F2X1.5LG6	C1.11
F2X1LG6	C1.11
F2X2LG6	C1.11
F2X3LG6	C1.11
F2X4LG6	C1.11
F2X5LG6	C1.11
F3X1LG6	C1.11
F3X2LG6	C1.11
F3X3LG6	C1.11
F3X4LG6	C1.11
F3X5LG6	C1.11
F4X2LG6	C1.11
F4X3LG6	C1.11
F4X4LG6	C1.11
F4X5LG6	C1.11
F73-5-M	D1.76
F73-7-M	D1.76
F74-5-M	D1.76
F74-7-M	D1.76
F75-10-M	D1.76
F75-6-M	D1.76
F75-8-M	D1.76
F76-10-M	D1.76
F76-12-M	D1.76
F76-6-M	D1.76
F76-8-M	D1.76
F77-10-M	D1.76
F77-12-M	D1.76

A. System Overview
B1. Cable Ties
B2. Cable Accessories
B3. Stainless Steel Ties
C1. Wiring Duct
C2. Surface Raceway
C3. Abrasion Protection
C4. Cable Management
D1. Terminals
D2. Power Connectors
D3. Grounding Connectors
E1. Labeling Systems
E2. Labels
E3. Pre-Printed & Write-On Markers
E4. Permanent Identification
E5. Lockout/Tagout & Safety Solutions
F. Index

PANDUIT® ELECTRICAL SOLUTIONS

A. System Overview	Part Number	Page Number	Part Number	Page Number	Part Number	Page Number
B1. Cable Ties	F77-6-M	D1.76	FIDT2X2YL	C1.58	FSD77-12-D	D1.73
	F77-7-M	D1.76	FIDT4X4BL	C1.58	FSD77-6-D	D1.73
	F77-8-M	D1.76	FITF4X4B	C1.59	FSD77-8-5K2	D1.142
	F78-10-M	D1.76	FIV452X2YL	C1.57	FSD77-8-D	D1.73
	F78-12-M	D1.76	FIV454X4YL	C1.57	FSD77-8-DSL2	D1.75, D1.141
	F78-15-M	D1.76	FIVRA2X2YL	C1.57	FSD78-10-D	D1.73
	F78-18-M	D1.76	FIVRA4X4YL	C1.57	FSD78-12-D	D1.73
	F78-20-M	D1.76	FL12X12LG-A	C1.26	FSD78-18-D	D1.73
	F78-7-M	D1.76	FL25X25LG-A	C1.26	FSD78-6-D	D1.73
	F78-8-M	D1.76	FL50X50LG-A	C1.26	FSD78-8-5K0	D1.142
B2. Cable Accessories	F80-10-M	D1.76	FLB	C1.60	FSD78-8-D	D1.73
	F80-12-M	D1.76	FLB12X15	C1.60	FSD78-8-DSL0	D1.75, D1.141
	F80-15-M	D1.76	FLB12X20	C1.60	FSD79-8-D	D1.73
	F80-18-M	D1.76	FLB58X15	C1.60	FSD80-12-D	D1.73
	F80-20-M	D1.76	FLB58X20	C1.60	FSD80-18-D	D1.73
	F80-7-M	D1.76	FLRB	C1.60	FSD80-8-3K6	D1.142
	F80-8-M	D1.76	FMWR-C	C1.29	FSD80-8-D	D1.73
	F81-10-M	D1.77	FOV452X2YL	C1.57	FSD80-8-DSL6	D1.75, D1.141
	F81-12-M	D1.77	FOV454X4YL	C1.57	FSD81-10-D	D1.73
	F81-15-M	D1.77	FOVRA2X2YL	C1.57	FSD81-12-C	D1.73
B3. Stainless Steel Ties	F81-18-M	D1.77	FOVRA4X4YL	C1.57	FSD81-18-C	D1.73
	F81-20-M	D1.77	FP2DCIW	C2.59	FSD82-12-C	D1.73
	F81-9-M	D1.77	FP2RCIW	C2.59	FSD82-18-C	D1.73
	F82-10-M	D1.77	FPC-600-A	D1.86	FSD83-12-C	D1.73
	F82-12-M	D1.77	FRA2X2YL	C1.56	FSD83-18-C	D1.73
	F82-15-M	D1.77	FRA4X4YL	C1.56	FSD84-12-C	D1.73
	F82-18-M	D1.77	FRAFC58	C1.61	FSD84-18-C	D1.73
	F82-20-M	D1.77	FRF42YL	C1.57	FSD85-16-L	D1.73
	F83-12-D	D1.77	FS.5X.5LG6NM	C1.17	FSD85-18-L	D1.73
	F83-15-D	D1.77	FS.5X1LG6NM	C1.17	FSD85-22-L	D1.73
C1. Wiring Duct	F83-18-D	D1.77	FS.75X.75LG6NM	C1.17	FSD86-16-L	D1.73
	F83-20-D	D1.77	FS1.5X1.5LG6NM	C1.17	FSD86-18-L	D1.73
	F83-25-D	D1.77	FS1.5X1LG6NM	C1.17	FSD86-25-L	D1.73
	F84-12-TL	D1.77	FS1.5X2LG6NM	C1.17	FSD87-20-L	D1.73
	F84-15-TL	D1.77	FS1.5X3LG6NM	C1.17	FSD87-25-Q	D1.73
	F84-18-TL	D1.77	FS156-C	B2.50	FSF72-6-D	D1.74
	F84-20-TL	D1.77	FS1X1.5LG6NM	C1.17	FSF72-8-D	D1.74
	F84-25-TL	D1.77	FS1X1LG6NM	C1.17	FSF73-6-D	D1.74
	F84-32-TL	D1.77	FS1X2LG6NM	C1.17	FSF73-8-D	D1.74
	F85-12-C	D1.77	FS1X3LG6NM	C1.17	FSF74-6-D	D1.74
C2. Surface Raceway	F85-15-C	D1.77	FS1X4LG6NM	C1.17	FSF74-8-D	D1.74
	F85-18-C	D1.77	FS2X1.5LG6NM	C1.17	FSF75-10-D	D1.74
	F85-25-C	D1.77	FS2X1LG6NM	C1.17	FSF75-6-D	D1.74
	F85-32-C	D1.77	FS2X2LG6NM	C1.17	FSF75-8-D	D1.74
	F86-18-C	D1.77	FS2X3LG6NM	C1.17	FSF76-10-D	D1.74
	F86-20-C	D1.77	FS2X4LG6NM	C1.17	FSF76-12-D	D1.74
	F86-25-C	D1.77	FS3X1LG6NM	C1.17	FSF76-6-D	D1.74
	F86-32-C	D1.77	FS3X2LG6NM	C1.17	FSF76-8-D	D1.74
	F87-18-C	D1.77	FS3X3LG6NM	C1.17	FSF77-10-D	D1.74
	F87-22-C	D1.77	FS3X4LG6NM	C1.17	FSF77-12-D	D1.74
C3. Abrasion Protection	F87-25-C	D1.77	FS3X5LG6NM	C1.17	FSF77-6-D	D1.74
	F87-32-C	D1.77	FS4X2LG6NM	C1.17	FSF77-8-D	D1.74
	FBA10IW-X	C2.79	FS4X3LG6NM	C1.17	FSF78-10-D	D1.74
	FBA5IW-X	C2.79	FS4X4LG6NM	C1.17	FSF78-12-D	D1.74
	FCB11-A-C20	B2.25	FS4X5LG6NM	C1.17	FSF78-18-D	D1.74
	FCB11-S10-C20	B2.25	FS6X4LG6NM	C1.17	FSF78-6-D	D1.74
	FCB12-A-C20	B2.25	FS75-8-5K3	D1.142	FSF78-8-D	D1.74
	FCB12-S10-C20	B2.25	FS75-8-DSL3	D1.75, D1.141	FSF79-8-D	D1.74
	FCB13-A-C20	B2.25	FS76-8-5K10	D1.142	FSF80-12-D	D1.74
	FCB13-S10-C20	B2.25	FS76-8-5K7	D1.142	FSF80-18-D	D1.74
C4. Cable Management	FCC-A-C8	B2.39	FS76-8-DSL10	D1.75, D1.141	FSF80-8-D	D1.74
	FCC5-A-C8	B2.39	FS76-8-DSL7	D1.75, D1.141	FSF81-10-D	D1.74
	FCF2X2YL	C1.56	FS77-8-5K4	D1.142	FSF81-12-C	D1.74
	FCF4X4YL	C1.56	FS77-8-DSL4	D1.75, D1.141	FSF81-18-C	D1.74
	FCH2-A-C14	B2.38	FS78-8-5K2	D1.142	FSF82-12-C	D1.74
	FCH2-S6-C14	B2.38	FS78-8-DSL2	D1.75, D1.141	FSF82-18-C	D1.74
	FCM1-A-C14	B2.38	FS80-8-3K8	D1.142	FSF83-12-C	D1.74
	FCM1-S6-C14	B2.38	FS80-8-DSL8	D1.75, D1.141	FSF83-18-C	D1.74
	FCM1.2-A-C14	B2.38	FSD72-6-D	D1.73	FSF84-12-C	D1.74
	FCM1.2-S6-C14	B2.38	FSD72-8-D	D1.73	FSF84-18-C	D1.74
D1. Terminals	FCM2-A-C14	B2.38	FSD73-6-D	D1.73	FSF85-16-L	D1.74
	FCM2-S6-C14	B2.38	FSD73-8-D	D1.73	FSF85-18-L	D1.74
	FCM3.25-A-L14	B2.38	FSD74-6-D	D1.73	FSF85-22-L	D1.74
	FCM3.25-S6-L14	B2.38	FSD74-8-D	D1.73	FSF86-16-L	D1.74
	FCPI1-C20	B2.25	FSD74-8-D	D1.73	FSF86-18-L	D1.74
	FCPI2-C20	B2.25	FSD75-10-D	D1.73	FSF86-25-L	D1.74
	FCPI3-C20	B2.25	FSD75-6-D	D1.73	FSF87-20-L	D1.74
	FEC2X2YL	C1.57	FSD75-8-5K10	D1.142	FSF87-25-Q	D1.74
	FEC4X4YL	C1.57	FSD75-8-D	D1.73	FSH40-X	B2.50
	FEIAB58	C1.61	FSD75-8-DSL10	D1.75, D1.141	FSSH-X	B2.50
D2. Power Connectors	FFWC2X2YL	C1.57	FSD76-10-D	D1.73	FT2X2YL	C1.57
	FFWC4X4YL	C1.57	FSD76-12-D	D1.73	FT4X4YL	C1.57
	FG1EI50-A	C2.83	FSD76-6-D	D1.73	FTD75-8-D	D1.75
	FG1EI6-A	C2.83	FSD76-8-5K8	D1.142	FTD76-10-D	D1.75
	FG3EI50-A	C2.83	FSD76-8-D	D1.73	FTD76-8-D	D1.75
	FG3EI6S-A	C2.83	FSD76-8-DSL8	D1.75, D1.141	FTD77-10-D	D1.75
	FSD77-10-D	D1.73	FSD77-10-D	D1.73		
	FSD77-6-D	D1.73				
	FSD77-8-5K2	D1.73				
	FSD77-8-D	D1.73				
D3. Grounding Connectors	FSD78-10-D	D1.73				
	FSD78-12-D	D1.73				
	FSD78-18-D	D1.73				
	FSD78-6-D	D1.73				
	FSD78-8-5K0	D1.73				
	FSD78-8-D	D1.73				
	FSD78-8-DSL0	D1.73				
	FSD79-8-D	D1.73				
	FSD80-12-D	D1.73				
	FSD80-18-D	D1.73				
E1. Labeling Systems	FSD80-8-3K6	D1.73				
	FSD80-8-D	D1.73				
	FSD80-8-DSL6	D1.73				
	FSD81-10-D	D1.73				
	FSD81-12-C	D1.73				
	FSD81-18-C	D1.73				
	FSD82-12-C	D1.73				
	FSD82-18-C	D1.73				
	FSD83-12-C	D1.73				
	FSD83-18-C	D1.73				
E2. Labels	FSD84-12-C	D1.73				
	FSD84-18-C	D1.73				
	FSD85-16-L	D1.73				
	FSD85-18-L	D1.73				
	FSD85-22-L	D1.73				
	FSD86-16-L	D1.73				
	FSD86-18-L	D1.73				
	FSD86-25-L	D1.73				
	FSD87-20-L	D1.73				
	FSD87-25-Q	D1.73				
E3. Pre-Printed & Write-On Markers	FSD88-10-D	D1.73				
	FSD88-12-D	D1.73				
	FSD88-18-D	D1.73				
	FSD88-6-D	D1.73				
	FSD88-8-D	D1.73				
	FSD89-10-D	D1.73				
	FSD89-12-D	D1.73				
	FSD89-18-D	D1.73				
	FSD89-6-D	D1.73				
	FSD89-8-D	D1.73				
E4. Permanent Identification	FSD90-10-D	D1.73				
	FSD90-12-D	D1.73				
	FSD90-18-D	D1.73				
	FSD90-6-D	D1.73				
	FSD90-8-D	D1.73				
	FSD91-10-D	D1.73				
	FSD91-12-D	D1.73				
	FSD91-18-D	D1.73				
	FSD91-6-D	D1.73				
	FSD91-8-D	D1.73				
E5. Lockout/Tagout & Safety Solutions	FSD92-10-D	D1.73				
	FSD92-12-D	D1.73				
	FSD92-18-D	D1.73				
	FSD92-6-D	D1.73				
	FSD92-8-D	D1.73				
	FSD93-10-D	D1.73				
	FSD93-12-D	D1.73				
	FSD93-18-D	D1.73				
	FSD93-6-D	D1.73				
	FSD93-8-D	D1.73				
F. Index	FSD94-10-D	D1.73				
	FSD94-12-D	D1.73				
	FSD94-18-D	D1.73				
	FSD94-6-D	D1.73				
	FSD94-8-D	D1.73				
	FSD95-10-D	D1.73				
	FSD95-12-D	D1.73				
	FSD95-18-D	D1.73				
	FSD95-6-D	D1.73				
	FSD95-8-D	D1.73				

PANDUIT® ELECTRICAL SOLUTIONS

Part Number	Page Number
FTD77-8-D	D1.75
FTD78-12-D	D1.75
FTD78-8-D	D1.75
FTD80-10-TL	D1.75
FTD80-13-TL	D1.75
FTD81-12-C	D1.75
FTD82-14-C	D1.75
FTR2X2YL	C1.58
FTR4X4YL	C1.58
FTRBE12	C1.60
FTRBE12M	C1.60
FTRBE58	C1.60
FTRBN12	C1.60
FTRBN12M	C1.60
FTRBN58	C1.60
FUSB	C1.60
FVT4X4YL	C1.58
FVTHD2X2YL	C1.58
FWR-C	C1.29
FZBA1.5X4	C1.60
FZBLP	C1.60

G

G.5X.5LG6	C1.9
G.5X1LG6	C1.9
G.5X2LG6	C1.9
G.5X4LG6	C1.9
G.75X.75LG6	C1.9
G.75X1.5LG6	C1.9
G.75X1LG6	C1.9
G.75X2LG6	C1.9
G1.5X1.5LG6	C1.9
G1.5X1LG6	C1.9
G1.5X2LG6	C1.9
G1.5X3LG6	C1.9
G1.5X4LG6	C1.9
G1X1.5LG6	C1.9
G1X1LG6	C1.9
G1X2LG6	C1.9
G1X3LG6	C1.9
G1X4LG6	C1.9
G2.5X3LG6	C1.9
G2X1.5LG6	C1.9
G2X1LG6	C1.9
G2X2LG6	C1.9
G2X3LG6	C1.9
G2X4LG6	C1.9
G2X5LG6	C1.9
G3X1LG6	C1.9
G3X2LG6	C1.9
G3X3LG6	C1.9
G3X4LG6	C1.9
G3X5LG6	C1.9
G4X1.5LG6	C1.9
G4X2LG6	C1.9
G4X3LG6	C1.9
G4X4LG6	C1.9
G4X5LG6	C1.9
G6X4LG6	C1.9
GB2B0304TPI-1	D3.5
GB2B0306TPI-1	D3.5
GB2B0312TPI-1	D3.5
GB4B0612TPI-1	D3.5
GB4B0624TPI-1	D3.5
GC-15A-Q	D3.25
GC-18A-X	D3.25
GC-22A-4	D3.25
GE128-C	C3.10
GE128-C69	C3.10
GE192-L	C3.10
GE192-L69	C3.10
GE255-L	C3.10
GE318-L	C3.10
GE380-Q	C3.10
GE510-Q	C3.10
GE52-C	C3.10
GE52-C69	C3.10
GE85-C	C3.10
GE85-C69	C3.10
GEE134N-C	C3.10
GEE144F-A-C	C3.9
GEE144F-A-C0	C3.9
GEE144F-C	C3.8
GEE144F-C0	C3.8
GEE144FR-C	C3.9

Part Number	Page Number
GEE36F-C	C3.8
GEE36F-C0	C3.8
GEE36FR-C	C3.9
GEE47N-C	C3.10
GEE55N-C	C3.10
GEE62F-A-C	C3.9
GEE62F-A-C0	C3.9
GEE62F-C	C3.8
GEE62F-C0	C3.8
GEE62FR-C	C3.9
GEE71N-C	C3.10
GEE98N-C	C3.10
GEE99F-A-C	C3.9
GEE99F-A-C0	C3.9
GEE99F-C	C3.8
GEE99F-C0	C3.8
GEE99FR-C	C3.9
GES144F-A-C	C3.9
GES144F-A-C0	C3.9
GES144F-C	C3.9
GES144F-C0	C3.9
GES144FR-C	C3.10
GES189F-C	C3.9
GES189F-C0	C3.9
GES36F-C	C3.9
GES36F-C0	C3.9
GES36FR-C	C3.10
GES62F-A-C	C3.9
GES62F-A-C0	C3.9
GES62F-C	C3.9
GES62F-C0	C3.9
GES62FR-C	C3.10
GES99F-A-C	C3.9
GES99F-A-C0	C3.9
GES99F-C	C3.9
GES99F-C0	C3.9
GES99FR-C	C3.10
GHH	B1.112
GM-2-Q	D3.26
GM-3-Q	D3.26
GMS-1-X	D3.26
GMS-2-Q	D3.26
GMS-3-Q	D3.26
GPL-10-Q	D3.22
GPL-14-X	D3.22
GPL-15-X	D3.22
GPL-16-X	D3.22
GPL-20-X	D3.22
GPL-21-X	D3.22
GPL-22-X	D3.22
GPL-26-X	D3.22
GPL-27-X	D3.22
GPL-28-X	D3.22
GPL-32-3	D3.22
GPL-33-3	D3.22
GPL-34-3	D3.22
GPL-39-3	D3.22
GPL-4-Q	D3.22
GPL-40-3	D3.22
GPL-44-1	D3.22
GPL-45-1	D3.22
GPL-46-1	D3.22
GPL-5-Q	D3.22
GPL-51-1	D3.22
GPL-52-1	D3.22
GPL-57-1	D3.22
GPL-58-1	D3.22
GPL-6-Q	D3.22
GPL-8-Q	D3.22
GPL-9-Q	D3.22
GPQC1/0	D3.4
GS2B	B1.109
GS4EH	B1.109
GS4H	B1.109
GS4MT	B3.14
GTH	B1.109
GTS	B1.109
GTSL	B1.109
GU-13-3	D3.23
GU-2-X	D3.23
GU-4-X	D3.23

H

H000X025H1C	E1.6
H000X025H2C	E1.6

Part Number	Page Number
H000X034H1C	E1.6
H000X034H2C	E1.6
H000X044H1C	E1.6
H000X044H2C	E1.6
H000X084H1C	E1.6
H000X084H2C	E1.6
H050X025F1T	E2.11
H050X025F1T-B	E2.11
H050X025F2T	E2.11
H050X025H1T	E2.13
H050X025H1T-B	E2.13
H050X025H2T	E2.13
H050X034F1T	E2.11
H050X034F1T-B	E2.11
H050X034F2T	E2.11
H050X034H1T	E2.13
H050X034H1T-B	E2.13
H050X034H2T	E2.13
H050X044F1T	E2.11
H050X044F1T-B	E2.11
H050X044F2T	E2.11
H050X044H1T	E2.13
H050X044H1T-B	E2.13
H050X044H2T	E2.13
H050X064F1T	E2.11
H050X064F1T-B	E2.11
H050X064H1T	E2.13
H050X064H1T-B	E2.13
H075X025F1T	E2.11
H075X025H1T	E2.13
H075X025H1T-B	E2.13
H075X034F1T	E2.11
H075X034H1T	E2.13
H075X044F1T	E2.11
H075X044H1T	E2.13
H1.5X2LG6	C1.7
H1.5X3LG6	C1.7
H100X025F1T	E2.11
H100X025F1T-B	E2.11
H100X025F2T	E2.11
H100X025H1C	E1.7
H100X025H1T	E2.13
H100X025H1T-B	E2.13
H100X025H2C	E1.7
H100X025H2T	E2.13
H100X034F1T	E2.12
H100X034F1T-B	E2.12
H100X034F2T	E2.12
H100X034H1C	E1.7
H100X034H1T	E2.13
H100X034H1T-B	E2.13
H100X034H2C	E1.7
H100X034H2T	E2.13
H100X044F1T	E2.12
H100X044F1T-B	E2.12
H100X044F2T	E2.12
H100X044H1C	E1.7
H100X044H1T	E2.14
H100X044H1T-B	E2.14
H100X044H2C	E1.7
H100X044H2C	E1.7
H100X044H2T	E2.14
H100X064F1T	E2.12
H100X064F1T-B	E2.12
H100X084F1T	E2.12
H100X084F2T	E2.12
H100X084H1C	E1.7
H100X084H1T	E2.14
H100X084H2C	E1.7
H100X084H2T	E2.14
H100X165F1T	E2.12
H100X165F2T	E2.12
H100X165H1T	E2.14
H100X165H2T	E2.14
H150X025F1T	E2.12
H150X025H1T	E2.14
H150X025H1T-B	E2.12
H150X025F2T	E2.12
H150X025H1T	E2.14
H150X044H1T	E2.14
H200X025F1T	E2.12
H200X025F1T-B	E2.12
H200X025F2T	E2.12
H200X025H1T	E2.14
H200X025H1T-B	E2.14

A.
System
Overview

B1.
Cable
Ties

B2.
Cable
Accessories

B3.
Stainless
Steel
Ties

C1.
Wiring
Duct

C2.
Surface
Raceway

C3.
Abrasion
Protection

C4.
Cable
Management

D1.
Terminals

D2.
Power
Connectors

D3.
Grounding
Connectors

E1.
Labeling
Systems

E2.
Labels

E3.
Pre-Printed
& Write-On
Markers

E4.
Permanent
Identification

E5.
Lockout/
Tagout
& Safety
Solutions

F.
Index

PANDUIT® ELECTRICAL SOLUTIONS

A. System Overview	Part Number	Page Number	Part Number	Page Number	Part Number	Page Number
B1. Cable Ties	H200X025H2T	E2.14	HLS-15R0	B1.87	HSTT05-M	C3.22
	H200X034F1T	E2.12	HLS-75R0	B1.87	HSTT05-Q	C3.23
	H200X034F1T-B	E2.12	HL51.5S-X0	B1.87	HSTT06-48-Q	C3.22
	H200X034F2T	E2.12	HL33S-X0	B1.87	HSTT06-48-TL	C3.22
B2. Cable Accessories	H200X034H1T	E2.14	HL55S-X0	B1.87	HSTT06-C	C3.22
	H200X034H1T-B	E2.14	HLSP1.5S-X0	B1.88	HSTT06-M	C3.22
	H200X034H2T	E2.14	HLSP1.5S-X12	B1.88	HSTT06-Q	C3.23
	H200X044F1T	E2.12	HLSP3S-X0	B1.88	HSTT06-Y	C3.24
	H200X044F1T-B	E2.12	HLSP3S-X12	B1.88	HSTT06-YK1	C3.24
	H200X044F2T	E2.12	HLSF5S-X0	B1.88	HSTT09-48-Q	C3.22
	H200X044H1T	E2.14	HLSF5S-X12	B1.88	HSTT09-48-TL	C3.22
	H200X044H1T-B	E2.14	HLT2I-X0	B1.87	HSTT09-C	C3.22
	H200X044H2T	E2.14	HLT3I-X0	B1.87	HSTT09-M	C3.22
	H200X064F1T	E2.12	HLTP2I-X0	B1.88	HSTT09-Q	C3.23
B3. Stainless Steel Ties	H200X064F1T-B	E2.12	HLTP2I-X12	B1.88	HSTT09-Y	C3.24
	H200X064H1T	E2.14	HLTP3I-X0	B1.88	HSTT09-YK1	C3.24
	H200X064H1T-B	E2.14	HLTP3I-X12	B1.88	HSTT100-48-5	C3.23
	H200X084F1T	E2.12	HN1.5X2LG6	C1.7	HSTT100-48-LQ	C3.23
C1. Wiring Duct	H200X084F2T	E2.12	HN1.5X3LG6	C1.7	HSTT100-C	C3.23
	H200X084H1T	E2.14	HN2X2LG6	C1.7	HSTT100-Y	C3.24
	H200X084H2T	E2.14	HN2X3LG6	C1.7	HSTT100-YK1	C3.24
	H200X165F1T	E2.12	HN2X4LG6	C1.7	HSTT12-48-Q	C3.22
C2. Surface Raceway	H200X165F2T	E2.12	HN3X3LG6	C1.7	HSTT12-48-TL	C3.22
	H200X165H1T	E2.14	HN3X4LG6	C1.7	HSTT12-C	C3.22
	H200X165H2T	E2.14	HN4X4LG6	C1.7	HSTT12-M	C3.22
	H2L13-2N-2	D2.140	HS1.5X2LG6NM	C1.7	HSTT12-Q	C3.23
C3. Abrasion Protection	H2L21-2N-2	D2.140	HS1.5X3LG6NM	C1.7	HSTT12-Y	C3.24
	H2L30-2N-1	D2.140	HS2X2LG6NM	C1.7	HSTT12-YK1	C3.24
	H2L4-2N-X	D2.140	HS2X3LG6NM	C1.7	HSTT150-48-5	C3.23
	H2L8-2N-2	D2.140	HS2X4LG6NM	C1.7	HSTT150-C	C3.23
	H2X2LG6	C1.7	HS3X3LG6NM	C1.7	HSTT19-48-Q	C3.22
	H2X3LG6	C1.7	HS3X4LG6NM	C1.7	HSTT19-48-TL	C3.22
	H2X4LG6	C1.7	HS4X4LG6NM	C1.7	HSTT19-C	C3.22
	H3X3LG6	C1.7	HSC.25-L	B2.42	HSTT19-M	C3.22
	H3X4LG6	C1.7	HSC.25-L100	B2.42	HSTT19-Q	C3.23
	H4X4LG6	C1.7	HSEC0.5-X	C3.37	HSTT19-Y	C3.24
C4. Cable Management	HB2SP19-X	B2.51	HSEC0.8-X	C3.37	HSTT19-YK1	C3.24
	HB2SP25-X	B2.51	HSEC1.0-X	C3.37	HSTT200-48-5	C3.23
	HBN.75-T	B2.49	HSEC1.5-5	C3.37	HSTT200-L	C3.23
	HBN1-T	B2.49	HSEC2.0-5	C3.37	HSTT25-48-Q	C3.22
D1. Terminals	HBN1.5-T	B2.49	HSEC4.0-2	C3.37	HSTT25-48-TL	C3.22
	HBN2-T	B2.49	HSECFR0.5-X	C3.37	HSTT25-C	C3.22
	HBN2.5-T	B2.49	HSECFR0.8-X	C3.37	HSTT25-D	C3.22
	HBN3-T	B2.49	HSECFR1.0-X	C3.37	HSTT25-Q	C3.23
D2. Power Connectors	HBN4-T	B2.49	HSECFR1.5-5	C3.37	HSTT25-Y	C3.24
	HBUA-X	B2.51	HSECFR2.0-5	C3.37	HSTT25-YK1	C3.24
	HC13-3	D2.141	HSG-115V-650	C3.38, E2.14	HSTT300-48-2	C3.23
	HC21-1	D2.141	HSG-A1	C3.38, E2.14	HSTT300-L	C3.23
	HC30-1	D2.141	HSG-A2	C3.38, E2.14	HSTT38-48-Q	C3.22
	HC4-3	D2.141	HSG-A3	C3.38, E2.14	HSTT38-48-TL	C3.22
	HC50-1	D2.141	HSG-A4	C3.38, E2.14	HSTT38-C	C3.22
	HC8-3	D2.141	HSG-P1	C3.38, E2.14	HSTT38-Q	C3.23
	HCME04Y09-C30	B2.45	HSG-P2	C3.38, E2.14	HSTT38-T	C3.22
	HCME06A12-C130	B2.45	HSG-P3	C3.38, E2.14	HSTT38-Y	C3.24
D3. Grounding Connectors	HCME06Y12-C30	B2.45	HSG-P7	C3.38, E2.14	HSTT38-YK1	C3.24
	HCMP06B12-C20	B2.44	HST0.4-3-Q	C3.35	HSTT400-48-2	C3.23
	HCMP06C12-C20	B2.44	HST0.4-48-5	C3.35	HSTT400-L	C3.23
	HHL13-2N-5	C2.139	HST0.4-6-3	C3.35	HSTT50-48-L	C3.23
	HHL21-2N-5	C2.139	HST0.4-6-X	C3.35	HSTT50-48-T	C3.23
	HHL30-22N-1	C2.139	HST0.8-12-5	C3.36	HSTT50-C	C3.23
	HHL8-2N-X	C2.139	HST0.8-48-5	C3.36	HSTT50-Q	C3.23
	HKBS	C3.14	HST0.8-6-3	C3.36	HSTT50-T	C3.23
	HL1-2-25-X	D2.138	HST0.8-6-X	C3.36	HSTT50-Y	C3.24
	HL1-25-X	D2.136	HST0.8-9-X	C3.36	HSTT50-YK1	C3.24
E1. Labeling Systems	HL13-1-5	D2.136	HST1.1-12-5	C3.36	HSTT75-48-5	C3.23
	HL13-2-5	D2.138	HST1.1-48-5	C3.36	HSTT75-48-CQ	C3.23
	HL13-2N-5	D2.139	HST1.1-6-3	C3.36	HSTT75-Q	C3.23
	HL21-1-5	D2.136	HST1.1-6-X	C3.36	HSTT75-T	C3.23
E2. Labels	HL21-2-5	D2.138	HST1.1-9-2	C3.36	HSTT75-Y	C3.24
	HL21-2N-5	D2.139	HST1.1-9-X	C3.36	HSTT75-YK1	C3.24
	HL30-1-2	D2.136	HST1.5-12-1	C3.36	HSTTA100-48-5	C3.34
	HL30-2-2	D2.138	HST1.5-12-5	C3.36	HSTTA100-48-L	C3.34
E3. Pre-Printed & Write-On Markers	HL30-2N-2	D2.139	HST1.5-48-5	C3.36	HSTTA100-Y	C3.34
	HL4-1-X	D2.136	HST1.5-9-X	C3.36	HSTTA150-48-5	C3.34
	HL4-2-X	D2.138	HST2.0-12-2	C3.36	HSTTA150-48-Q	C3.34
	HL50-1-2	D2.136	HST2.0-48-2	C3.36	HSTTA150-Y	C3.34
E4. Permanent Identification	HL50-2-2	D2.138	HST2.0-9-5	C3.36	HSTTA19-48-Q	C3.34
	HL8-1-X	D2.136	HST3.0-12-2	C3.36	HSTTA19-Y	C3.34
	HL8-2-X	D2.138	HST3.0-48-2	C3.36	HSTTA25-48-Q	C3.34
	HL8-2N-X	D2.139	HSTT-YK1	C3.25	HSTTA25-48-TL	C3.34
	HLA13-1-90-5	D2.137	HSTT-YK1-45	C3.25	HSTTA25-Y	C3.34
	HLA21-1-90-5	D2.137	HSTT-YK2	C3.25	HSTTA38-48-Q	C3.34
	HLA4-1-90-X	D2.137	HSTT-YK2-45	C3.25	HSTTA38-48-TL	C3.34
	HLA8-1-90-X	D2.137	HSTT05-48-Q	C3.22	HSTTA38-Y	C3.34
	HLB4-1-X	D2.136	HSTT05-48-TL	C3.22	HSTTA50-48-5	C3.34
	HLM-15R0	B1.87	HSTT05-C	C3.22	HSTTA50-48-T	C3.34

PANDUIT® ELECTRICAL SOLUTIONS

Part Number	Page Number	Part Number	Page Number	Part Number	Page Number
HSTTA50-Y	C3.34	HSTTT150-48-2	C3.32	HSTTV50-T2	C3.28
HSTTA75-48-5	C3.34	HSTTT19-48-Q	C3.32	HSTTV50-T4	C3.28
HSTTA75-48-C	C3.34	HSTTT24-48-Q	C3.32	HSTTV50-T6	C3.28
HSTTA75-Y	C3.34	HSTTT30-48-Q	C3.32	HSTTV50-Y	C3.29
HSTTK05-48-Q	C3.33	HSTTT37-48-Q	C3.32	HSTTV75-48-5	C3.26
HSTTK06-48-Q	C3.33	HSTTT43-48-Q	C3.32	HSTTV75-48-CQ	C3.26
HSTTK09-48-Q	C3.33	HSTTT47-48-Q	C3.32	HSTTV75-C	C3.27
HSTTK100-48-5	C3.33	HSTTT56-48-5	C3.32	HSTTV75-Q	C3.29
HSTTK12-48-Q	C3.33	HSTTT66-48-5	C3.32	HSTTV75-T	C3.28
HSTTK19-48-Q	C3.33	HSTTT75-48-5	C3.32	HSTTV75-T2	C3.28
HSTTK25-48-Q	C3.33	HSTTT93-48-5	C3.32	HSTTV75-T4	C3.28
HSTTK38-48-Q	C3.33	HSTTV05-48-Q	C3.26	HSTTV75-T6	C3.28
HSTTK50-48-5	C3.33	HSTTV05-48-TL	C3.26	HSTTV75-Y	C3.29
HSTTK75-48-5	C3.33	HSTTV05-C	C3.27	HSTTV100-48-5	C3.33
HSTTN100-C	C3.31	HSTTV05-M	C3.28	HSTTV100-Y	C3.34
HSTTN125-C	C3.31	HSTTV05-M2	C3.28	HSTTV12-48-Q	C3.33
HSTTN150-C	C3.31	HSTTV05-M4	C3.28	HSTTV12-Y	C3.34
HSTTN200-Q	C3.31	HSTTV05-M6	C3.28	HSTTV150-48-5	C3.33
HSTTN25-C	C3.31	HSTTV05-Q	C3.29	HSTTV19-48-Q	C3.33
HSTTN300-Q	C3.31	HSTTV05-Y	C3.29	HSTTV19-Y	C3.34
HSTTN38-C	C3.31	HSTTV06-48-Q	C3.26	HSTTV25-48-Q	C3.33
HSTTN50-C	C3.31	HSTTV06-48-TL	C3.26	HSTTV25-Y	C3.34
HSTTN63-C	C3.31	HSTTV06-C	C3.27	HSTTV38-48-Q	C3.33
HSTTN75-C	C3.31	HSTTV06-M	C3.28	HSTTV38-Y	C3.34
HSTTN88-C	C3.31	HSTTV06-M2	C3.28	HSTTV50-48-5	C3.33
HSTTP05-CY	C3.30	HSTTV06-M4	C3.28	HSTTV50-Y	C3.34
HSTTP05-MY	C3.30	HSTTV06-M6	C3.28	HSTTV75-48-5	C3.33
HSTTP05-QY	C3.30	HSTTV06-Q	C3.29	HSTTV75-Y	C3.34
HSTTP06-CY	C3.30	HSTTV06-Y	C3.29	HT2-BLU	E5.32
HSTTP06-MY	C3.30	HSTTV09-48-Q	C3.26	HT2-GRN	E5.32
HSTTP06-QY	C3.30	HSTTV09-48-TL	C3.26	HT2-ORN	E5.32
HSTTP09-CY	C3.30	HSTTV09-C	C3.27	HT2-RED	E5.32
HSTTP09-MY	C3.30	HSTTV09-M	C3.28	HT2-WHT	E5.32
HSTTP09-QY	C3.30	HSTTV09-M2	C3.28	HT2-YEL	E5.32
HSTTP100-CY	C3.30	HSTTV09-M4	C3.28	HT2S-BLK-YEL	E5.31
HSTTP100-QY	C3.30	HSTTV09-M6	C3.28	HT2S-RED-WHT	E5.31
HSTTP12-CY	C3.30	HSTTV09-Q	C3.29	HT3S-BLK-YEL	E5.31
HSTTP12-MY	C3.30	HSTTV09-Y	C3.29	HT3S-RED-WHT	E5.31
HSTTP12-QY	C3.30	HSTTV100-48-5	C3.26	HTAP1-1-Q	D2.122
HSTTP150-CY	C3.30	HSTTV100-48-LQ	C3.26	HTAP1/0-1-Q	D2.122
HSTTP150-QY	C3.30	HSTTV100-C	C3.27	HTAP2-8-L	D2.122
HSTTP19-CY	C3.30	HSTTV100-Q	C3.29	HTAP2/0-1-Q	D2.122
HSTTP19-MY	C3.30	HSTTV100-Y	C3.29	HTAP3/0-1-Q	D2.122
HSTTP19-QY	C3.30	HSTTV12-48-Q	C3.26	HTAP3/0-3/0-Q	D2.122
HSTTP200-QY	C3.30	HSTTV12-48-TL	C3.26	HTAP4/0-2-Q	D2.122
HSTTP25-CY	C3.30	HSTTV12-C	C3.27	HTAP4/0-3/0-Q	D2.122
HSTTP25-DY	C3.30	HSTTV12-M	C3.28	HTAP4/0-4/0-Q	D2.122
HSTTP25-QY	C3.30	HSTTV12-M2	C3.28	HTAP500-4/0-X	D2.122
HSTTP38-CY	C3.30	HSTTV12-M4	C3.28	HTAP500-500-X	D2.122
HSTTP38-QY	C3.30	HSTTV12-M6	C3.28	HTB3-C-M	E5.34
HSTTP38-TY	C3.30	HSTTV12-Q	C3.29	HTB3-DNE-M	E5.34
HSTTP50-CY	C3.30	HSTTV12-Y	C3.29	HTB3-HV-M	E5.34
HSTTP50-QY	C3.30	HSTTV150-48-5	C3.26	HTCT1000-1000-1	D3.10
HSTTP75-CY	C3.30	HSTTV150-C	C3.27	HTCT1000-250-1	D3.10
HSTTP75-QY	C3.30	HSTTV19-48-Q	C3.26	HTCT2-2-1	D3.9
HSTTPN100-775-Q	C3.31	HSTTV19-48-TL	C3.26	HTCT250-2-1	D3.9
HSTTPN100-CC	C3.31	HSTTV19-C	C3.27	HTCT250-250-1	D3.9
HSTTPN150-925-X	C3.31	HSTTV19-M	C3.28	HTCT250-8-1	D3.9
HSTTPN150-CC	C3.31	HSTTV19-M2	C3.28	HTCT500-250-1	D3.10
HSTTPN200-950-X	C3.31	HSTTV19-M4	C3.28	HTCT500-500-1	D3.10
HSTTPN200-CC	C3.31	HSTTV19-M6	C3.28	HTCT6-6-1	D3.9
HSTTPN50-438-L	C3.31	HSTTV19-Q	C3.29	HTCT750-4/0-1	D3.10
HSTTPN50-713-Q	C3.31	HSTTV19-Y	C3.29	HTCT750-750-1	D3.10
HSTTPN50-CC	C3.31	HSTTV25-48-Q	C3.26	HTCT8-8-1	D3.9
HSTTPN62-750-Q	C3.31	HSTTV25-48-TL	C3.26	HTDU2B-W	E5.33
HSTTPN62-CC	C3.31	HSTTV25-C	C3.27	HTDU2O-FO	E5.33
HSTTPN75-775-Q	C3.31	HSTTV25-D	C3.28	HTDU2O-T	E5.33
HSTTPN75-CC	C3.31	HSTTV25-D2	C3.28	HTDU2R-E	E5.33
HSTTRA100-48-5	C3.35	HSTTV25-D4	C3.28	HTDU3O-FO	E5.33
HSTTRA12-48-Q	C3.35	HSTTV25-D6	C3.28	HTDU3O-T	E5.33
HSTTRA19-48-Q	C3.35	HSTTV25-Q	C3.29	HTDU3R-E	E5.33
HSTTRA25-48-Q	C3.35	HSTTV25-Y	C3.29	HTDU6O-FO	E5.33
HSTTRA38-48-Q	C3.35	HSTTV38-48-Q	C3.26	HTDU6O-T	E5.33
HSTTRA50-48-5	C3.35	HSTTV38-48-TL	C3.26	HTDU6R-E	E5.33
HSTTT03-48-Q	C3.32	HSTTV38-C	C3.27	HTMT	B3.15
HSTTT04-48-Q	C3.32	HSTTV38-Q	C3.29	HTU3G-T-M	E5.33
HSTTT046-48-Q	C3.32	HSTTV38-T	C3.28	HTU3O-FO-M	E5.33
HSTTT05-48-Q	C3.32	HSTTV38-T2	C3.28	HTU3O-T-M	E5.33
HSTTT055-48-Q	C3.32	HSTTV38-T4	C3.28	HTU3R-E-M	E5.33
HSTTT06-48-Q	C3.32	HSTTV38-T6	C3.28	HTU3Y-E-M	E5.33
HSTTT08-48-Q	C3.32	HSTTV38-Y	C3.29	HTU6O-FO	E5.33
HSTTT09-48-Q	C3.32	HSTTV50-48-Q	C3.26	HTU6O-T	E5.33
HSTTT112-48-5	C3.32	HSTTV50-48-T	C3.26	HTU6O-TV	E5.33
HSTTT12-48-Q	C3.32	HSTTV50-C	C3.27	HTU6R-E	E5.33
HSTTT131-48-2	C3.32	HSTTV50-Q	C3.29	HTU6Y-E	E5.33
HSTTT15-48-Q	C3.32	HSTTV50-T	C3.28	HTU6Y-G	E5.33

A. System Overview
B1. Cable Ties
B2. Cable Accessories
B3. Stainless Steel Ties
C1. Wiring Duct
C2. Surface Raceway
C3. Abrasion Protection
C4. Cable Management
D1. Terminals
D2. Power Connectors
D3. Grounding Connectors
E1. Labeling Systems
E2. Labels
E3. Pre-Printed & Write-On Markers
E4. Permanent Identification
E5. Lockout/Tagout & Safety Solutions
F. Index

PANDUIT® ELECTRICAL SOLUTIONS

A. System Overview	Part Number	Page Number	Part Number	Page Number	Part Number	Page Number
B1. Cable Ties	HTWC1000-1000-1	D3.12	JBP2IW	C2.57, C2.58	K1-PNKIT	D1.38
	HTWC1000-250-1	D3.12	JBP2SIW	C2.58	K2-BLD2	B1.112
	HTWC2-2-1	D3.11	JBX3510IW-A	C2.57	K2-PVKITY	D1.38
	HTWC250-2-1	D3.11	JMCB-X	C4.7	K4EH-BLD	B1.112
	HTWC250-250-1	D3.11	JMCM25-1-X	C4.7	K4H-BLD	B1.112
	HTWC250-8-1	D3.11	JMCM25-3-X	C4.7	K4M-BLD	B3.14
	HTWC500-250-1	D3.12	JMDWB-1-X	C4.7	K4MTG	B3.14
	HTWC500-500-1	D3.12	JMDWB-3-X	C4.7	K600-A	D1.86
	HTWC6-6-1	D3.11	JMJH2-X20	C4.7	KB-550	B1.84
	HTWC750-4/0-1	D3.12	JMJH2W-X20	C4.7	KB-551	B1.84
B2. Cable Accessories	HTWC750-750-1	D3.12	JMN2-C	D1.69	KGTHBLD	B1.112
	HTWC8-8-1	D3.11	JMN6-C	D1.69	KGTHSLV	B1.112
	HV9100-C0	B1.62	JMSBCB87-1-X	C4.7	KGTHTL	B1.112
	HV9150-C0	B1.62	JMSBCB87-3-X	C4.7	KGTSBLD	B1.112
	HV9250-C0	B1.62	JMTRB38-1-X	C4.7	KGTSLSV	B1.112
	HV965-C0	B1.62	JMTRB38-3-X	C4.7	KGSTSL	B1.112
	HVMPM32-C0	B1.62, B2.21	JN218-216-C	D1.67	KH-1-L	D3.24
	HVTM3S10-C0	B1.62, B2.13	JN224-318-C	D1.67	KH-2-L	D3.24
	HWS2819-C	B2.43	JN314-412-C	D1.67	KIMS-H366-C2	B2.14
			JN418-212-C	D1.67	KIMS-H430-C6	B2.14
C1. Wiring Duct			JP131CM-L20	C4.4	KIMS-H500-C4	B2.14
			JP131CP-L20	C4.6	KLM14-250Y	D2.153
			JP131DW-L20	C4.4	KLM350-800Y	D2.153
			JP131HBC25R-L20	C4.5	KLM6-250Y	D2.153
			JP131HBC50R-L20	C4.5	KLM6-600Y	D2.153
			JP131HBC75R-L20	C4.5	KLM6-800Y	D2.153
			JP131SBC50-L20	C4.5	KLS-0-Q	D3.24
			JP131SBC50R-L20	C4.5	KLS-1-Q	D3.24
			JP131SBC87-L20	C4.5	KLS-1A-X	D3.24
			JP131SBC87R-L20	C4.5	KMTRTH	B3.20
C2. Surface Raceway			JP131UF100-L20	C4.6	KMTRTLs	B3.20
			JP131WP-L20	C4.4	KP-1000	D1.36
			JP131ZP-L20	C4.6	KP-1075Y	D1.36
			JP2CM-L20	C4.4	KP-1165Y	D1.36
			JP2CP-L20	C4.6	KP-1166	D1.36
			JP2DW-L20	C4.4	KP-506A	B1.84
			JP2HBC25R-L20	C4.5	KP-506A-0	B1.84
			JP2HBC50R-L20	C4.5	KP-509	B1.84
			JP2HBC75R-L20	C4.5	KP-F1	D1.78
			JP2SBC50-L20	C4.5	KP-F2	D1.78
C3. Abrasion Protection			JP2SBC50R-L20	C4.5	KP-FSD1	D1.78
			JP2SBC87-L20	C4.5	KP-FSD2	D1.78
			JP2SBC87R-L20	C4.5	KP-FSD3	D1.78
			JP2UF100-L20	C4.6	KP-HSTT1	C3.38
			JP2W-L20	C4.4	KP-HSTT2	C3.38
			JP2WP-L20	C4.4	KP-HSTTA	C3.38
			JP2ZP-L20	C4.6	KP1-C	D3.23
			JP4CM-X20	C4.4	KP2-L	D3.23
			JP4CP-X20	C4.6	KPPTMTG	B3.16
			JP4HBC25R-X20	C4.5	KPPTMTB	B3.16
C4. Cable Management			JP4HBC50R-X20	C4.5	KPTHBLD	B1.112
			JP4HBC75R-X20	C4.5	KPTSTL	B1.112
			JP4SBC50-X20	C4.5		
			JP4SBC50R-X20	C4.5		
			JP4SBC87-X20	C4.5		
			JP4SBC87R-X20	C4.5		
			JP4UF100-X20	C4.6		
			JP4W-X20	C4.4		
			JP4WP-X20	C4.4		
			JP4ZP-X20	C4.6		
D1. Terminals			JP75CM-L20	C4.4		
			JP75CP-L20	C4.6		
			JP75DW-L20	C4.4		
			JP75HBC25R-L20	C4.5		
			JP75HBC50R-L20	C4.5		
			JP75HBC75R-L20	C4.5		
			JP75SBC50-L20	C4.5		
			JP75SBC50R-L20	C4.5		
			JP75SBC87-L20	C4.5		
			JP75SBC87R-L20	C4.5		
D2. Power Connectors			JP75UF100-L20	C4.6		
			JP75WP-L20	C4.4		
			JP75ZP-L20	C4.6		
			K-1000	D1.37		
			K-1001	D1.37		
			K-1100	D1.37		
			K-1102Y	D1.37		
			K-1103Y	D1.37		
			K-1104	D1.37		
			K-205	B1.83, D1.38		
D3. Grounding Connectors			K-504	B1.83		
E1. Labeling Systems						
E2. Labels						
E3. Pre-Printed & Write-On Markers						
E4. Permanent Identification						
E5. Lockout/Tagout & Safety Solutions						
F. Index						

Part Number	Page Number	Part Number	Page Number	Part Number	Page Number
LAB1000-12-1	D2.117	LCA1/0-38-X	D2.14	LCA350-38H-X	D2.16
LAB2/0-12-5	D2.117	LCA1/0-38F-X	D2.17	LCA350-58-X	D2.14
LAB250-12-5	D2.117	LCA1/0-38H-X	D2.16	LCA350-58F-X	D2.18
LAB3/0-12-5	D2.117	LCA1/0-56-X	D2.14	LCA350-58H-X	D2.16
LAB300-12-2	D2.117	LCA1/0-56F-X	D2.17	LCA350-78-X	D2.14
LAB350-12-2	D2.117	LCA1/0-56H-X	D2.16	LCA350-78F-X	D2.18
LAB4/0-12-5	D2.117	LCA10-10-L	D2.13	LCA350-78H-X	D2.16
LAB400-12-2	D2.117	LCA10-14-L	D2.13	LCA4-00-L	D2.21
LAB500-12-2	D2.117	LCA10-14F-L	D2.17	LCA4-10-L	D2.13
LAB600-12-2	D2.117	LCA10-14H-L	D2.15	LCA4-10F-L	D2.17
LAB750-12-1	D2.117	LCA10-38-L	D2.13	LCA4-10H-L	D2.15
LAB800-12-1	D2.117	LCA10-56-L	D2.13	LCA4-14-L	D2.13
LAM2A1/0-14-6Y	D2.148	LCA2-00-Q	D2.21	LCA4-14F-L	D2.17
LAM2A1000-58-6Y	D2.148	LCA2-12-Q	D2.13	LCA4-14H-L	D2.15
LAM2A2/0-14-6Y	D2.148	LCA2-12F-Q	D2.17	LCA4-38-L	D2.13
LAM2A250-38-6Y	D2.148	LCA2-12H-Q	D2.15	LCA4-38F-L	D2.17
LAM2A350-12-6Y	D2.148	LCA2-14-Q	D2.13	LCA4-38H-L	D2.15
LAM2A600-12-6Y	D2.148	LCA2-14F-Q	D2.17	LCA4-56-L	D2.13
LAM2A800-58-6Y	D2.148	LCA2-14H-Q	D2.15	LCA4-56F-L	D2.17
LAM2B350-12-3Y	D2.149	LCA2-38-Q	D2.13	LCA4-56H-L	D2.15
LAM2B600-12-3Y	D2.149	LCA2-38F-Q	D2.17	LCA4/0-00-X	D2.21
LAM2LB800-12-3Y	D2.149	LCA2-38H-Q	D2.15	LCA4/0-12-X	D2.14
LAM2SA300-56-3	D2.149	LCA2-56-Q	D2.13	LCA4/0-12F-X	D2.18
LAM2SB600-38-1Y	D2.150	LCA2-56F-Q	D2.17	LCA4/0-12H-X	D2.16
LAM2SB750-38-1Y	D2.150	LCA2-56H-Q	D2.15	LCA4/0-14-X	D2.14
LAM2SSB500-141Y	D2.150	LCA2/0-00-X	D2.21	LCA4/0-14F-X	D2.18
LAM3B1/0-38-6Y	D2.150	LCA2/0-12-X	D2.14	LCA4/0-14H-X	D2.16
LAM3B2-14-6Y	D2.150	LCA2/0-12F-X	D2.17	LCA4/0-38-X	D2.14
LAM3B250-12-1Y	D2.150	LCA2/0-12H-X	D2.16	LCA4/0-38F-X	D2.18
LAM3B3/0-12-3Y	D2.150	LCA2/0-14-X	D2.14	LCA4/0-38H-X	D2.16
LAM3B350-12-1Y	D2.150	LCA2/0-14F-X	D2.17	LCA4/0-56-X	D2.14
LAM3B600-12-1Y	D2.150	LCA2/0-14H-X	D2.16	LCA4/0-56F-X	D2.18
LAM3D250-12-1Y	D2.151	LCA2/0-34H-X	D2.16	LCA4/0-56H-X	D2.16
LAM3D3/0-12-3Y	D2.151	LCA2/0-38-X	D2.14	LCA400-00-6	D2.21
LAM3D350-12-1Y	D2.151	LCA2/0-38F-X	D2.17	LCA400-12-6	D2.14
LAM3D600-12-1Y	D2.151	LCA2/0-38H-X	D2.16	LCA400-12F-6	D2.18
LAM3LB1000-121Y	D2.150	LCA2/0-56-X	D2.14	LCA400-12H-6	D2.16
LAM3LB800-12-1Y	D2.150	LCA2/0-56F-X	D2.17	LCA400-38-6	D2.14
LAM3LD1000-121Y	D2.151	LCA2/0-56H-X	D2.16	LCA400-38F-6	D2.18
LAM3LD800-12-1Y	D2.151	LCA250-12-X	D2.14	LCA400-38H-6	D2.16
LAM3SB600-38-1Y	D2.151	LCA250-12F-X	D2.18	LCA400-58-6	D2.14
LAM3SB750-38-1Y	D2.151	LCA250-12H-X	D2.16	LCA400-58F-6	D2.18
LAM4D250-12-1Y	D2.152	LCA250-14-X	D2.14	LCA400-58H-6	D2.16
LAM4D350-12-1Y	D2.152	LCA250-14F-X	D2.18	LCA400-78-6	D2.14
LAM4D600-12-1Y	D2.152	LCA250-14H-X	D2.16	LCA400-78F-6	D2.18
LAM4LD800-12-1Y	D2.152	LCA250-38-X	D2.14	LCA400-78H-6	D2.16
LAM4SB600-38-1Y	D2.152	LCA250-38F-X	D2.18	LCA500-00-6	D2.21
LAM4SB750-38-1Y	D2.152	LCA250-38H-X	D2.16	LCA500-1-6	D2.14
LAMA1/0-14-QY	D2.147	LCA250-56-X	D2.14	LCA500-12-6	D2.14
LAMA1000-58-6Y	D2.147	LCA250-56F-X	D2.18	LCA500-12F-6	D2.18
LAMA2-14-QY	D2.147	LCA250-56H-X	D2.16	LCA500-12H-6	D2.16
LAMA2/0-14-QY	D2.147	LCA3/0-00-X	D2.21	LCA500-1F-6	D2.18
LAMA250-56-QY	D2.147	LCA3/0-12-X	D2.14	LCA500-1H-6	D2.16
LAMA300-56-QY	D2.147	LCA3/0-12F-X	D2.18	LCA500-34-6	D2.14
LAMA350-38-QY	D2.147	LCA3/0-12H-X	D2.16	LCA500-34F-6	D2.18
LAMA500-38-6Y	D2.147	LCA3/0-14-X	D2.14	LCA500-34H-6	D2.16
LAMA6-14-QY	D2.147	LCA3/0-14F-X	D2.18	LCA500-38-6	D2.14
LAMA600-38-6Y	D2.147	LCA3/0-14H-X	D2.16	LCA500-38F-6	D2.18
LAMA600S-38-6Y	D2.147	LCA3/0-38-X	D2.14	LCA500-38H-6	D2.16
LAMA800-58-6Y	D2.147	LCA3/0-38F-X	D2.18	LCA500-58-6	D2.14
LAMB350-12-6Y	D2.148	LCA3/0-38H-X	D2.16	LCA500-58F-6	D2.18
LAMB600-12-3Y	D2.148	LCA3/0-56-X	D2.14	LCA500-58H-6	D2.16
LAMLB800-12-3Y	D2.148	LCA3/0-56F-X	D2.18	LCA500-78-6	D2.14
LC10-A-L8	B2.37	LCA3/0-56H-X	D2.16	LCA500-78F-6	D2.18
LC3-A-C8	B2.37	LCA300-00-X	D2.21	LCA500-78H-6	D2.16
LC5-A-C8	B2.37	LCA300-12-X	D2.14	LCA6-00-L	D2.21
LCA1-00-E	D2.21	LCA300-12F-X	D2.18	LCA6-10-L	D2.13
LCA1-12-E	D2.13	LCA300-12H-X	D2.16	LCA6-10F-L	D2.17
LCA1-12F-E	D2.17	LCA300-38-X	D2.14	LCA6-10H-L	D2.15
LCA1-12H-E	D2.16	LCA300-38F-X	D2.18	LCA6-14-L	D2.13
LCA1-14-E	D2.13	LCA300-38H-X	D2.16	LCA6-14F-L	D2.17
LCA1-14F-E	D2.17	LCA300-56-X	D2.14	LCA6-14H-L	D2.15
LCA1-14H-E	D2.16	LCA300-56F-X	D2.18	LCA6-38-L	D2.13
LCA1-38-E	D2.13	LCA300-56H-X	D2.16	LCA6-38F-L	D2.17
LCA1-38F-E	D2.17	LCA300-58-X	D2.14	LCA6-38H-L	D2.15
LCA1-38H-E	D2.16	LCA300-58F-X	D2.18	LCA6-56-L	D2.13
LCA1-56-E	D2.13	LCA300-58H-X	D2.16	LCA6-56F-L	D2.17
LCA1-56F-E	D2.17	LCA300-78-X	D2.14	LCA6-56H-L	D2.15
LCA1-56H-E	D2.16	LCA300-78F-X	D2.18	LCA600-00-6	D2.21
LCA1/0-00-X	D2.21	LCA300-78H-X	D2.16	LCA600-12-6	D2.14
LCA1/0-12-X	D2.14	LCA350-00-X	D2.21	LCA600-12F-6	D2.18
LCA1/0-12F-X	D2.17	LCA350-12-X	D2.14	LCA600-12H-6	D2.16
LCA1/0-12H-X	D2.16	LCA350-12F-X	D2.18	LCA600-58-6	D2.14
LCA1/0-14-X	D2.14	LCA350-12H-X	D2.16	LCA600-58F-6	D2.18
LCA1/0-14F-X	D2.17	LCA350-38-X	D2.14	LCA600-58H-6	D2.16
LCA1/0-14H-X	D2.16	LCA350-38F-X	D2.18	LCA600-78-6	D2.14

A.
System Overview

B1.
Cable Ties

B2.
Cable Accessories

B3.
Stainless Steel Ties

C1.
Wiring Duct

C2.
Surface Raceway

C3.
Abrasion Protection

C4.
Cable Management

D1.
Terminals

D2.
Power Connectors

D3.
Grounding Connectors

E1.
Labeling Systems

E2.
Labels

E3.
Pre-Printed & Write-On Markers

E4.
Permanent Identification

E5.
Lockout/Tagout & Safety Solutions

F.
Index

PANDUIT® ELECTRICAL SOLUTIONS

A. System Overview	Part Number	Page Number	Part Number	Page Number	Part Number	Page Number
B1. Cable Ties	LCA600-78F-6	D2.18	LCAF3/0-56F-X	D2.79	LCAF8-14-L	D2.74
	LCA600-78H-6	D2.16	LCAF3/0-56H-X	D2.77	LCAF8-14F-L	D2.78
	LCA750-58-6	D2.14	LCAF300-12-6	D2.75	LCAF8-14H-L	D2.76
	LCA8-00-L	D2.21	LCAF300-12F-6	D2.79	LCAF8-38-L	D2.74
	LCA8-10-L	D2.13	LCAF300-12H-6	D2.77	LCAF8-38F-L	D2.78
B2. Cable Accessories	LCA8-10F-L	D2.17	LCAF300-38-6	D2.75	LCAF8-38H-L	D2.76
	LCA8-10H-L	D2.15	LCAF300-38F-6	D2.79	LCAF8-56-L	D2.74
	LCA8-14-L	D2.13	LCAF300-38H-6	D2.77	LCAF8-56F-L	D2.78
	LCA8-14F-L	D2.17	LCAF300-58-6	D2.75	LCAF8-56H-L	D2.76
	LCA8-14H-L	D2.15	LCAF300-58F-6	D2.79	LCAN1-10-E	D2.19
B3. Stainless Steel Ties	LCA8-38-L	D2.13	LCAF300-58H-6	D2.77	LCAN1-14-E	D2.19
	LCA8-38F-L	D2.17	LCAF300-78-6	D2.75	LCAN1/0-10-X	D2.19
	LCA8-38H-L	D2.15	LCAF300-78F-6	D2.79	LCAN1/0-14-X	D2.19
	LCA8-56-L	D2.13	LCAF300-78H-6	D2.77	LCAN1/0-56-X	D2.19
	LCA8-56F-L	D2.17	LCAF350-1-6	D2.75	LCAN2-10-Q	D2.19
C1. Wiring Duct	LCA8-56H-L	D2.15	LCAF350-12-6	D2.75	LCAN2-14-Q	D2.19
	LCAF1-12-X	D2.74	LCAF350-12F-6	D2.79	LCAN2/0-10-X	D2.19
	LCAF1-12F-X	D2.78	LCAF350-12H-6	D2.77	LCAN2/0-14-X	D2.19
	LCAF1-12H-X	D2.76	LCAF350-1F-6	D2.79	LCAN2/0-38-X	D2.19
	LCAF1-14-X	D2.74	LCAF350-1H-6	D2.77	LCAN2/0-56-X	D2.19
C2. Surface Raceway	LCAF1-14F-X	D2.78	LCAF350-34-6	D2.75	LCAN250-14-X	D2.20
	LCAF1-14H-X	D2.76	LCAF350-34F-6	D2.79	LCAN250-38-X	D2.20
	LCAF1-38-X	D2.74	LCAF350-34H-6	D2.77	LCAN3/0-14-X	D2.19
	LCAF1-38F-X	D2.78	LCAF350-38-6	D2.75	LCAN3/0-38-X	D2.19
	LCAF1-38H-X	D2.76	LCAF350-38F-6	D2.79	LCAN3/0-56-X	D2.19
C3. Abrasion Protection	LCAF1-56-X	D2.74	LCAF350-38H-6	D2.77	LCAN300-14-X	D2.20
	LCAF1-56F-X	D2.78	LCAF350-58-6	D2.75	LCAN300-38-X	D2.20
	LCAF1-56H-X	D2.76	LCAF350-58F-6	D2.79	LCAN350-12-X	D2.20
	LCAF1/0-12-X	D2.74	LCAF350-58H-6	D2.77	LCAN350-38-X	D2.20
	LCAF1/0-12F-X	D2.78	LCAF350-78-6	D2.75	LCAN4-10-L	D2.19
C4. Cable Management	LCAF1/0-12H-X	D2.76	LCAF350-78F-6	D2.79	LCAN4-14-L	D2.19
	LCAF1/0-14-X	D2.74	LCAF350-78H-6	D2.77	LCAN4/0-14-X	D2.19
	LCAF1/0-14F-X	D2.78	LCAF4-10-L	D2.74	LCAN4/0-38-X	D2.19
	LCAF1/0-14H-X	D2.76	LCAF4-10F-L	D2.78	LCAN4/0-56-X	D2.19
	LCAF1/0-38-X	D2.74	LCAF4-10H-L	D2.76	LCAN400-12-6	D2.20
D1. Terminals	LCAF1/0-38F-X	D2.78	LCAF4-14-L	D2.74	LCAN400-38-6	D2.20
	LCAF1/0-38H-X	D2.76	LCAF4-14F-L	D2.78	LCAN500-12-6	D2.20
	LCAF1/0-56-X	D2.74	LCAF4-14H-L	D2.76	LCAN500-38-6	D2.20
	LCAF1/0-56F-X	D2.78	LCAF4-38-L	D2.74	LCAN6-6-L	D2.19
	LCAF1/0-56H-X	D2.76	LCAF4-38F-L	D2.78	LCAN600-12-6	D2.20
D2. Power Connectors	LCAF2-12-E	D2.74	LCAF4-38H-L	D2.76	LCAN600-38-6	D2.20
	LCAF2-12F-E	D2.78	LCAF4-56-L	D2.74	LCAN750-12-6	D2.20
	LCAF2-12H-E	D2.76	LCAF4-56F-L	D2.78	LCAN750-38-6	D2.20
	LCAF2-14-E	D2.74	LCAF4-56H-L	D2.76	LCAN750-58-6	D2.20
	LCAF2-14F-E	D2.78	LCAF4/0-12-X	D2.75	LCAN8-6-L	D2.19
D3. Grounding Connectors	LCAF2-14H-E	D2.76	LCAF4/0-12F-X	D2.79	LCAS1-12-E	D2.7
	LCAF2-38-E	D2.74	LCAF4/0-12H-X	D2.77	LCAS1-12F-E	D2.11
	LCAF2-38F-E	D2.78	LCAF4/0-14-X	D2.75	LCAS1-12H-E	D2.9
	LCAF2-38H-E	D2.76	LCAF4/0-14F-X	D2.79	LCAS1-14-E	D2.7
	LCAF2-56-E	D2.74	LCAF4/0-14H-X	D2.77	LCAS1-14F-E	D2.11
E1. Labeling Systems	LCAF2-56F-E	D2.78	LCAF4/0-38-X	D2.75	LCAS1-14H-E	D2.9
	LCAF2-56H-E	D2.76	LCAF4/0-38F-X	D2.79	LCAS1-38-E	D2.7
	LCAF2/0-12-X	D2.74	LCAF4/0-38H-X	D2.77	LCAS1-38F-E	D2.11
	LCAF2/0-12F-X	D2.78	LCAF4/0-56-X	D2.75	LCAS1-38H-E	D2.9
	LCAF2/0-12H-X	D2.76	LCAF4/0-56F-X	D2.79	LCAS1-56-E	D2.7
E2. Labels	LCAF2/0-14-X	D2.74	LCAF4/0-56H-X	D2.77	LCAS1-56F-E	D2.11
	LCAF2/0-14F-X	D2.78	LCAF400-12-6	D2.75	LCAS1-56H-E	D2.9
	LCAF2/0-14H-X	D2.76	LCAF400-12F-6	D2.79	LCAS1/0-12-X	D2.7
	LCAF2/0-38-X	D2.74	LCAF400-12H-6	D2.77	LCAS1/0-12F-X	D2.11
	LCAF2/0-38F-X	D2.78	LCAF400-58-6	D2.75	LCAS1/0-12H-X	D2.9
E3. Pre-Printed & Write-On Markers	LCAF2/0-38H-X	D2.76	LCAF400-58F-6	D2.79	LCAS1/0-14-X	D2.7
	LCAF2/0-56-X	D2.74	LCAF400-58H-6	D2.77	LCAS1/0-14F-X	D2.11
	LCAF2/0-56F-X	D2.78	LCAF400-78-6	D2.75	LCAS1/0-14H-X	D2.9
	LCAF2/0-56H-X	D2.76	LCAF400-78F-6	D2.79	LCAS1/0-38-X	D2.7
	LCAF250-12-X	D2.75	LCAF400-78H-6	D2.77	LCAS1/0-38F-X	D2.11
E4. Permanent Identification	LCAF250-12F-X	D2.79	LCAF500-12-6	D2.75	LCAS1/0-38H-X	D2.9
	LCAF250-12H-X	D2.77	LCAF500-58-6	D2.75	LCAS1/0-56-X	D2.7
	LCAF250-38-X	D2.75	LCAF6-10-L	D2.74	LCAS1/0-56F-X	D2.11
	LCAF250-38F-X	D2.79	LCAF6-10F-L	D2.78	LCAS1/0-56H-X	D2.9
	LCAF250-38H-X	D2.77	LCAF6-10H-L	D2.76	LCAS2-12-Q	D2.7
E5. Lockout/Tagout & Safety Solutions	LCAF250-58-X	D2.75	LCAF6-14-L	D2.74	LCAS2-12F-Q	D2.11
	LCAF250-58F-X	D2.79	LCAF6-14F-L	D2.78	LCAS2-12H-Q	D2.9
	LCAF250-58H-X	D2.77	LCAF6-14H-L	D2.76	LCAS2-14-Q	D2.7
	LCAF250-78-X	D2.75	LCAF6-38-L	D2.74	LCAS2-14F-Q	D2.11
	LCAF250-78F-X	D2.79	LCAF6-38F-L	D2.78	LCAS2-14H-Q	D2.9
F. Index	LCAF250-78H-X	D2.77	LCAF6-38H-L	D2.76	LCAS2-38-Q	D2.7
	LCAF3/0-12-X	D2.75	LCAF6-56-L	D2.74	LCAS2-38F-Q	D2.11
	LCAF3/0-12F-X	D2.79	LCAF6-56F-L	D2.78	LCAS2-38H-Q	D2.9
	LCAF3/0-12H-X	D2.77	LCAF6-56H-L	D2.76	LCAS2-56-Q	D2.7
	LCAF3/0-14-X	D2.75	LCAF600-12-6	D2.75	LCAS2-56F-Q	D2.11
LCAF3/0-14F-X	D2.79	LCAF600-58-6	D2.75	LCAS2-56H-Q	D2.9	
LCAF3/0-14H-X	D2.77	LCAF750-12-3	D2.75	LCAS2/0-12-X	D2.7	
LCAF3/0-38-X	D2.75	LCAF750-58-3	D2.75	LCAS2/0-12F-X	D2.11	
LCAF3/0-38F-X	D2.79	LCAF8-10-L	D2.74	LCAS2/0-12H-X	D2.9	
LCAF3/0-38H-X	D2.77	LCAF8-10F-L	D2.78	LCAS2/0-14-X	D2.7	
LCAF3/0-56-X	D2.75	LCAF8-10H-L	D2.76	LCAS2/0-14F-X	D2.11	

PANDUIT® ELECTRICAL SOLUTIONS

Part Number	Page Number	Part Number	Page Number	Part Number	Page Number
LCAS2/0-14H-X	D2.9	LCAX1-14F-X	D2.70	LCAX3/0-56-X	D2.67
LCAS2/0-38-X	D2.7	LCAX1-14H-X	D2.68	LCAX3/0-56F-X	D2.71
LCAS2/0-38F-X	D2.11	LCAX1-38-X	D2.66	LCAX3/0-56H-X	D2.69
LCAS2/0-38H-X	D2.9	LCAX1-38F-X	D2.70	LCAX300-12-6	D2.67
LCAS2/0-56-X	D2.7	LCAX1-38H-X	D2.68	LCAX300-12F-6	D2.71
LCAS2/0-56F-X	D2.11	LCAX1-56-X	D2.66	LCAX300-12H-6	D2.69
LCAS2/0-56H-X	D2.9	LCAX1-56F-X	D2.70	LCAX300-38-6	D2.67
LCAS250-12-X	D2.8	LCAX1-56H-X	D2.68	LCAX300-38F-6	D2.71
LCAS250-12F-X	D2.12	LCAX1/0-12-X	D2.66	LCAX300-38H-6	D2.69
LCAS250-12H-X	D2.10	LCAX1/0-12F-X	D2.70	LCAX300-58-6	D2.67
LCAS250-14-X	D2.8	LCAX1/0-12H-X	D2.68	LCAX300-58F-6	D2.71
LCAS250-14F-X	D2.12	LCAX1/0-14-X	D2.66	LCAX300-58H-6	D2.69
LCAS250-14H-X	D2.10	LCAX1/0-14F-X	D2.70	LCAX350-12-6	D2.67
LCAS250-38-X	D2.8	LCAX1/0-14H-X	D2.68	LCAX350-12F-6	D2.71
LCAS250-38F-X	D2.12	LCAX1/0-38-X	D2.66	LCAX350-12H-6	D2.69
LCAS250-38H-X	D2.10	LCAX1/0-38F-X	D2.70	LCAX350-38-6	D2.67
LCAS250-56-X	D2.8	LCAX1/0-38H-X	D2.68	LCAX350-38F-6	D2.71
LCAS250-56F-X	D2.12	LCAX1/0-56-X	D2.66	LCAX350-38H-6	D2.69
LCAS250-56H-X	D2.10	LCAX1/0-56F-X	D2.70	LCAX350-56-6	D2.67
LCAS3/0-12-X	D2.8	LCAX1/0-56H-X	D2.68	LCAX350-56F-6	D2.71
LCAS3/0-12F-X	D2.12	LCAX2-10-E	D2.66	LCAX350-56H-6	D2.69
LCAS3/0-12H-X	D2.10	LCAX2-10F-E	D2.70	LCAX350-58-6	D2.67
LCAS3/0-14-X	D2.8	LCAX2-10H-E	D2.68	LCAX350-58F-6	D2.71
LCAS3/0-14F-X	D2.12	LCAX2-12-E	D2.66	LCAX350-58H-6	D2.69
LCAS3/0-14H-X	D2.10	LCAX2-12F-E	D2.70	LCAX4-10-L	D2.66
LCAS3/0-38-X	D2.8	LCAX2-12H-E	D2.68	LCAX4-10F-L	D2.70
LCAS3/0-38F-X	D2.12	LCAX2-14-E	D2.66	LCAX4-10H-L	D2.68
LCAS3/0-38H-X	D2.10	LCAX2-14F-E	D2.70	LCAX4-14-L	D2.66
LCAS3/0-56-X	D2.8	LCAX2-14H-E	D2.68	LCAX4-14F-L	D2.70
LCAS3/0-56F-X	D2.12	LCAX2-38-E	D2.66	LCAX4-14H-L	D2.68
LCAS3/0-56H-X	D2.10	LCAX2-38F-E	D2.70	LCAX4-38-L	D2.66
LCAS4-10-L	D2.7	LCAX2-38H-E	D2.68	LCAX4-38F-L	D2.70
LCAS4-10F-L	D2.11	LCAX2-56-E	D2.66	LCAX4-38H-L	D2.68
LCAS4-10H-L	D2.9	LCAX2-56F-E	D2.70	LCAX4-56-L	D2.66
LCAS4-14-L	D2.7	LCAX2-56H-E	D2.68	LCAX4-56F-L	D2.70
LCAS4-14F-L	D2.11	LCAX2/0-10-X	D2.67	LCAX4-56H-L	D2.68
LCAS4-14H-L	D2.9	LCAX2/0-10F-X	D2.71	LCAX4/0-12-X	D2.67
LCAS4-38-L	D2.7	LCAX2/0-10H-X	D2.69	LCAX4/0-12F-X	D2.71
LCAS4-38F-L	D2.11	LCAX2/0-12-X	D2.67	LCAX4/0-12H-X	D2.69
LCAS4-38H-L	D2.9	LCAX2/0-12F-X	D2.71	LCAX4/0-14-X	D2.67
LCAS4-56-L	D2.7	LCAX2/0-12H-X	D2.69	LCAX4/0-14F-X	D2.71
LCAS4-56F-L	D2.11	LCAX2/0-14-X	D2.67	LCAX4/0-14H-X	D2.69
LCAS4-56H-L	D2.9	LCAX2/0-14F-X	D2.71	LCAX4/0-34-X	D2.67
LCAS4/0-12-X	D2.8	LCAX2/0-14H-X	D2.69	LCAX4/0-34F-X	D2.71
LCAS4/0-12F-X	D2.12	LCAX2/0-34-X	D2.67	LCAX4/0-34H-X	D2.69
LCAS4/0-12H-X	D2.10	LCAX2/0-34F-X	D2.71	LCAX4/0-38-X	D2.67
LCAS4/0-14-X	D2.8	LCAX2/0-34H-X	D2.69	LCAX4/0-38F-X	D2.71
LCAS4/0-14F-X	D2.12	LCAX2/0-38-X	D2.67	LCAX4/0-38H-X	D2.69
LCAS4/0-14H-X	D2.10	LCAX2/0-38F-X	D2.71	LCAX4/0-56-X	D2.67
LCAS4/0-38-X	D2.8	LCAX2/0-38H-X	D2.69	LCAX4/0-56F-X	D2.71
LCAS4/0-38F-X	D2.12	LCAX2/0-56-X	D2.67	LCAX4/0-56H-X	D2.69
LCAS4/0-38H-X	D2.10	LCAX2/0-56F-X	D2.71	LCAX4/0-58-X	D2.67
LCAS4/0-56-X	D2.8	LCAX2/0-56H-X	D2.69	LCAX4/0-58F-X	D2.71
LCAS4/0-56F-X	D2.12	LCAX2/0-58-X	D2.67	LCAX4/0-58H-X	D2.69
LCAS4/0-56H-X	D2.10	LCAX2/0-58F-X	D2.71	LCAX450-12-6	D2.67
LCAS6-10-L	D2.7	LCAX2/0-58H-X	D2.69	LCAX450-12F-6	D2.71
LCAS6-10F-L	D2.11	LCAX250-12-X	D2.67	LCAX450-12H-6	D2.69
LCAS6-10H-L	D2.9	LCAX250-12F-X	D2.71	LCAX450-58-6	D2.67
LCAS6-14-L	D2.7	LCAX250-12H-X	D2.69	LCAX450-58F-6	D2.71
LCAS6-14F-L	D2.11	LCAX250-14-X	D2.67	LCAX450-58H-6	D2.69
LCAS6-14H-L	D2.9	LCAX250-14F-X	D2.71	LCAX500-12-6	D2.67
LCAS6-38-L	D2.7	LCAX250-14H-X	D2.69	LCAX500-12F-6	D2.71
LCAS6-38F-L	D2.11	LCAX250-34-X	D2.67	LCAX500-12H-6	D2.69
LCAS6-38H-L	D2.9	LCAX250-34F-X	D2.71	LCAX500-38-6	D2.67
LCAS6-56-L	D2.7	LCAX250-34H-X	D2.69	LCAX500-38F-6	D2.71
LCAS6-56F-L	D2.11	LCAX250-38-X	D2.67	LCAX500-38H-6	D2.69
LCAS6-56H-L	D2.9	LCAX250-38F-X	D2.71	LCAX500-56-6	D2.67
LCAS8-10-L	D2.7	LCAX250-38H-X	D2.69	LCAX500-56F-6	D2.71
LCAS8-10F-L	D2.11	LCAX250-56-X	D2.67	LCAX500-56H-6	D2.69
LCAS8-10H-L	D2.9	LCAX250-56F-X	D2.71	LCAX500-58-6	D2.67
LCAS8-14-L	D2.7	LCAX250-56H-X	D2.69	LCAX500-58F-6	D2.71
LCAS8-14F-L	D2.11	LCAX250-58-X	D2.67	LCAX500-58H-6	D2.69
LCAS8-14H-L	D2.9	LCAX250-58F-X	D2.71	LCAX6-10-L	D2.66
LCAS8-38-L	D2.7	LCAX250-58H-X	D2.69	LCAX6-10F-L	D2.70
LCAS8-38F-L	D2.11	LCAX3/0-10-X	D2.67	LCAX6-10H-L	D2.68
LCAS8-38H-L	D2.9	LCAX3/0-10F-X	D2.71	LCAX6-14-L	D2.66
LCAS8-56-L	D2.7	LCAX3/0-10H-X	D2.69	LCAX6-14F-L	D2.70
LCAS8-56F-L	D2.11	LCAX3/0-12-X	D2.67	LCAX6-14H-L	D2.68
LCAS8-56H-L	D2.9	LCAX3/0-12F-X	D2.71	LCAX6-38-L	D2.66
LCAX1-10-X	D2.66	LCAX3/0-12H-X	D2.69	LCAX6-38F-L	D2.70
LCAX1-10F-X	D2.70	LCAX3/0-14-X	D2.67	LCAX6-38H-L	D2.68
LCAX1-10H-X	D2.68	LCAX3/0-14F-X	D2.71	LCAX6-56-L	D2.66
LCAX1-12-X	D2.66	LCAX3/0-14H-X	D2.69	LCAX6-56F-L	D2.70
LCAX1-12F-X	D2.70	LCAX3/0-38-X	D2.67	LCAX6-56H-L	D2.68
LCAX1-12H-X	D2.68	LCAX3/0-38F-X	D2.71	LCAX650-12-6	D2.67
LCAX1-14-X	D2.66	LCAX3/0-38H-X	D2.69	LCAX650-12F-6	D2.71

A. System Overview
B1. Cable Ties
B2. Cable Accessories
B3. Stainless Steel Ties
C1. Wiring Duct
C2. Surface Raceway
C3. Abrasion Protection
C4. Cable Management
D1. Terminals
D2. Power Connectors
D3. Grounding Connectors
E1. Labeling Systems
E2. Labels
E3. Pre-Printed & Write-On Markers
E4. Permanent Identification
E5. Lockout/Tagout & Safety Solutions
F. Index

PANDUIT® ELECTRICAL SOLUTIONS

A. System Overview	Part Number	Page Number	Part Number	Page Number	Part Number	Page Number
B1. Cable Ties	LCAX650-12H-6	D2.69	LCB300-38F-X	D2.27	LCBX1-38-X	D2.80
	LCAX650-38-6	D2.67	LCB300-38H-X	D2.25	LCBX1-38F-X	D2.82
	LCAX650-38F-6	D2.71	LCB300-56-X	D2.23	LCBX1-38H-X	D2.81
	LCAX650-38H-6	D2.69	LCB300-56F-X	D2.27	LCBX1-56-X	D2.80
B2. Cable Accessories	LCAX650-56-6	D2.67	LCB300-56H-X	D2.25	LCBX1-56F-X	D2.82
	LCAX650-56F-6	D2.71	LCB350-12-X	D2.23	LCBX1-56H-X	D2.81
	LCAX650-56H-6	D2.69	LCB350-12F-X	D2.27	LCBX1/0-12-X	D2.80
	LCAX650-58-6	D2.67	LCB350-12H-X	D2.25	LCBX1/0-12F-X	D2.82
B3. Stainless Steel Ties	LCAX650-58F-6	D2.71	LCB350-78-X	D2.23	LCBX1/0-12H-X	D2.81
	LCAX750-12-3	D2.67	LCB350-78F-X	D2.27	LCBX1/0-14-X	D2.80
	LCAX750-12F-3	D2.71	LCB350-78H-X	D2.25	LCBX1/0-14F-X	D2.82
	LCAX750-12H-3	D2.69	LCB4-10-L	D2.22	LCBX1/0-14H-X	D2.81
C1. Wiring Duct	LCAX750-58-3	D2.67	LCB4-10F-L	D2.26	LCBX1/0-38-X	D2.80
	LCAX750-58F-3	D2.71	LCB4-10H-L	D2.24	LCBX1/0-38F-X	D2.82
	LCAX750-58H-3	D2.69	LCB4-14-L	D2.22	LCBX1/0-38H-X	D2.81
	LCAX8-10-L	D2.66	LCB4-14F-L	D2.26	LCBX2-12-E	D2.80
C2. Surface Raceway	LCAX8-10F-L	D2.70	LCB4-14H-L	D2.24	LCBX2-12F-E	D2.82
	LCAX8-10H-L	D2.68	LCB4-38-L	D2.22	LCBX2-12H-E	D2.81
	LCAX8-14-L	D2.66	LCB4-56-L	D2.22	LCBX2-14-E	D2.80
	LCAX8-14F-L	D2.70	LCB4/0-12-X	D2.23	LCBX2-14F-E	D2.82
C3. Abrasion Protection	LCAX8-14H-L	D2.68	LCB4/0-12F-X	D2.26	LCBX2-14H-E	D2.81
	LCAX8-38-L	D2.66	LCB4/0-12H-X	D2.25	LCBX2-38-E	D2.80
	LCAX8-38F-L	D2.70	LCB4/0-38-X	D2.23	LCBX2-38F-E	D2.82
	LCAX8-38H-L	D2.68	LCB4/0-38F-X	D2.26	LCBX2-38H-E	D2.81
C4. Cable Management	LCAX8-56-L	D2.66	LCB4/0-38H-X	D2.25	LCBX2/0-12-X	D2.80
	LCAX8-56F-L	D2.70	LCB400-12-6	D2.23	LCBX2/0-12F-X	D2.82
	LCAX8-56H-L	D2.68	LCB400-12F-6	D2.27	LCBX2/0-12H-X	D2.81
	LCAXN250-12-X	D2.72	LCB400-12H-6	D2.25	LCBX2/0-14-X	D2.80
D1. Terminals	LCAXN250-12F-X	D2.73	LCB400-38-6	D2.23	LCBX2/0-14F-X	D2.82
	LCAXN250-12H-X	D2.72	LCB400-58-6	D2.23	LCBX2/0-14H-X	D2.81
	LCB1-10-E	D2.22	LCB400-58F-6	D2.27	LCBX2/0-38-X	D2.80
	LCB1-10F-E	D2.26	LCB400-58H-6	D2.25	LCBX2/0-38F-X	D2.82
D2. Power Connectors	LCB1-10H-E	D2.24	LCB400-78-6	D2.23	LCBX2/0-38H-X	D2.81
	LCB1-38-E	D2.22	LCB400-78F-6	D2.27	LCBX250-38-X	D2.80
	LCB1-56-E	D2.22	LCB400-78H-6	D2.25	LCBX250-38F-X	D2.82
	LCB1-56F-E	D2.26	LCB500-12-6	D2.23	LCBX250-38H-X	D2.81
D3. Grounding Connectors	LCB1-56H-E	D2.24	LCB500-12F-6	D2.27	LCBX3/0-38-X	D2.80
	LCB1/0-10-X	D2.22	LCB500-12H-6	D2.25	LCBX3/0-38F-X	D2.82
	LCB1/0-10F-X	D2.26	LCB500-58-6	D2.23	LCBX3/0-38H-X	D2.81
	LCB1/0-10H-X	D2.24	LCB500-58F-6	D2.27	LCBX300-12F-6	D2.82
E1. Labeling Systems	LCB1/0-12-X	D2.22	LCB500-58H-6	D2.25	LCBX300-12H-6	D2.81
	LCB1/0-12F-X	D2.26	LCB500-78-6	D2.23	LCBX300-38-6	D2.80
	LCB1/0-12H-X	D2.24	LCB500-78F-6	D2.27	LCBX300-38F-6	D2.82
	LCB1/0-38-X	D2.22	LCB500-78H-6	D2.25	LCBX300-38H-6	D2.81
E2. Labels	LCB1/0-38F-X	D2.26	LCB6-10-L	D2.22	LCBX350-12-6	D2.80
	LCB1/0-38H-X	D2.24	LCB6-10F-L	D2.26	LCBX350-12F-6	D2.82
	LCB1/0-56-X	D2.22	LCB6-10H-L	D2.24	LCBX350-12H-6	D2.81
	LCB1/0-56F-X	D2.26	LCB6-14-L	D2.22	LCBX350-38-6	D2.80
E3. Pre-Printed & Write-On Markers	LCB1/0-56H-X	D2.24	LCB6-14F-L	D2.26	LCBX350-38F-6	D2.82
	LCB10-14W-L	D2.28	LCB6-14H-L	D2.24	LCBX350-38H-6	D2.81
	LCB10-14WF-L	D2.29	LCB6-38-L	D2.22	LCBX4-14-L	D2.80
	LCB10-14WH-L	D2.29	LCB6-38F-L	D2.26	LCBX4-14F-L	D2.82
E4. Permanent Identification	LCB1000-12W-3	D2.28	LCB6-38H-L	D2.24	LCBX4-14H-L	D2.81
	LCB1000-38W-3	D2.28	LCB600-12-6	D2.23	LCBX4-38-L	D2.80
	LCB1000-58-3	D2.23	LCB600-12F-6	D2.27	LCBX4-38F-L	D2.82
	LCB1000-58W-3	D2.28	LCB600-12H-6	D2.25	LCBX4-38H-L	D2.81
E5. Lockout/Tagout & Safety Solutions	LCB2-10-Q	D2.22	LCB600-58-6	D2.23	LCBX4/0-12-X	D2.80
	LCB2-10F-Q	D2.26	LCB600-58F-6	D2.27	LCBX4/0-12F-X	D2.82
	LCB2-10H-Q	D2.24	LCB600-58H-6	D2.25	LCBX4/0-12H-X	D2.81
	LCB2-38-Q	D2.22	LCB750-12W-6	D2.28	LCBX4/0-38-X	D2.80
F. Index	LCB2-56-Q	D2.22	LCB750-38W-6	D2.28	LCBX4/0-38F-X	D2.82
	LCB2-56F-Q	D2.26	LCB750-58-6	D2.23	LCBX4/0-38H-X	D2.81
	LCB2-56H-Q	D2.24	LCB750-58W-6	D2.28	LCBX450-38-6	D2.80
	LCB2/0-12-X	D2.23	LCB750-78-6	D2.23	LCBX450-38F-6	D2.82
F. Index	LCB2/0-12F-X	D2.26	LCB750-78W-6	D2.28	LCBX450-38H-6	D2.81
	LCB2/0-12H-X	D2.24	LCB8-10-L	D2.22	LCBX500-12-6	D2.80
	LCB2/0-38-X	D2.23	LCB8-10F-L	D2.26	LCBX500-12F-6	D2.82
	LCB2/0-38F-X	D2.26	LCB8-10H-L	D2.24	LCBX500-12H-6	D2.81
F. Index	LCB2/0-38H-X	D2.24	LCB8-14-L	D2.22	LCBX500-38-6	D2.80
	LCB250-12-X	D2.23	LCB8-14F-L	D2.26	LCBX500-38F-6	D2.82
	LCB250-12F-X	D2.27	LCB8-14H-L	D2.24	LCBX500-38H-6	D2.81
	LCB250-12H-X	D2.25	LCB8-38-L	D2.22	LCBX6-14-L	D2.80
F. Index	LCB250-78-X	D2.23	LCB800-12W-6	D2.28	LCBX6-14F-L	D2.82
	LCB250-78F-X	D2.27	LCB800-58-6	D2.23	LCBX6-14H-L	D2.81
	LCB250-78H-X	D2.25	LCB800-58W-6	D2.28	LCBX6-38-L	D2.80
	LCB3/0-12-X	D2.23	LCBH1-38-E	D2.30	LCBX6-38F-L	D2.82
F. Index	LCB3/0-12F-X	D2.26	LCBH1/0-38-X	D2.30	LCBX6-38H-L	D2.81
	LCB3/0-12H-X	D2.24	LCBH2-38-Q	D2.30	LCBX8-10-L	D2.80
	LCB3/0-38-X	D2.23	LCBH2/0-12-X	D2.30	LCBX8-10F-L	D2.82
	LCB3/0-38F-X	D2.26	LCBH250-12-X	D2.30	LCBX8-10H-L	D2.81
F. Index	LCB3/0-38H-X	D2.24	LCBH3/0-12-X	D2.30	LCBX8-14-L	D2.80
	LCB300-12-X	D2.23	LCBH4-38-L	D2.30	LCBX8-14F-L	D2.82
	LCB300-12F-X	D2.27	LCBH4/0-12-X	D2.30	LCBX8-14H-L	D2.81
	LCB300-12H-X	D2.25	LCBX1-14-X	D2.80	LCBX8-38-L	D2.80
F. Index	LCB300-38-X	D2.23	LCBX1-14F-X	D2.82	LCBX8-38F-L	D2.82
			LCBX1-14H-X	D2.81	LCBX8-38H-L	D2.81

PANDUIT® ELECTRICAL SOLUTIONS

Part Number	Page Number	Part Number	Page Number	Part Number	Page Number
LCC1-00-E	D2.57	LCC10-14BWF-L	D2.53	LCC2/0-14AW-X	D2.48
LCC1-00W-E	D2.58	LCC10-14BWH-L	D2.50	LCC2/0-14AWF-X	D2.54
LCC1-12-E	D2.41	LCC10-14JAW-L	D2.47	LCC2/0-14AWH-X	D2.51
LCC1-12F-E	D2.46	LCC10-14JAWF-L	D2.53	LCC2/0-14B-X	D2.42
LCC1-12H-E	D2.44	LCC10-14JAWH-L	D2.50	LCC2/0-14BF-X	D2.46
LCC1-12W-E	D2.48	LCC1000-00-3	D2.57	LCC2/0-14BH-X	D2.44
LCC1-12WF-E	D2.54	LCC1000-12-3	D2.42	LCC2/0-14BW-X	D2.48
LCC1-12WH-E	D2.51	LCC1000-12W-3	D2.49	LCC2/0-14BWF-X	D2.54
LCC1-14A-E	D2.41	LCC1000-38D-3	D2.42	LCC2/0-14BWH-X	D2.51
LCC1-14AF-E	D2.46	LCC1000-38DW-3	D2.49	LCC2/0-38D-X	D2.42
LCC1-14AH-E	D2.44	LCC2-00-Q	D2.57	LCC2/0-38DF-X	D2.46
LCC1-14AW-E	D2.48	LCC2-00W-Q	D2.58	LCC2/0-38DH-X	D2.44
LCC1-14AWF-E	D2.54	LCC2-10AW-Q	D2.48	LCC2/0-38DW-X	D2.48
LCC1-14AWH-E	D2.51	LCC2-10AWF-Q	D2.54	LCC2/0-38DWF-X	D2.54
LCC1-14B-E	D2.41	LCC2-10AWH-Q	D2.51	LCC2/0-38DWH-X	D2.51
LCC1-14BF-E	D2.46	LCC2-10BW-Q	D2.48	LCC2/0-56D-X	D2.42
LCC1-14BH-E	D2.44	LCC2-10BWF-Q	D2.54	LCC2/0-56DF-X	D2.46
LCC1-14BW-E	D2.48	LCC2-10BWH-Q	D2.51	LCC2/0-56DH-X	D2.44
LCC1-14BWF-E	D2.54	LCC2-12-Q	D2.41	LCC2/0-56DW-X	D2.48
LCC1-14BWH-E	D2.51	LCC2-12F-Q	D2.45	LCC2/0-56DWF-X	D2.54
LCC1-38D-E	D2.41	LCC2-12H-Q	D2.43	LCC2/0-56DWH-X	D2.51
LCC1-38DF-E	D2.46	LCC2-12W-Q	D2.48	LCC250-00-X	D2.57
LCC1-38DH-E	D2.44	LCC2-12WF-Q	D2.54	LCC250-00W-X	D2.58
LCC1-38DW-E	D2.48	LCC2-12WH-Q	D2.51	LCC250-12-X	D2.42
LCC1-38DWF-E	D2.54	LCC2-14A-Q	D2.41	LCC250-12D-X	D2.42
LCC1-38DWH-E	D2.51	LCC2-14AF-Q	D2.45	LCC250-12DF-X	D2.46
LCC1-56B-E	D2.41	LCC2-14AH-Q	D2.43	LCC250-12DH-X	D2.44
LCC1-56BF-E	D2.46	LCC2-14AW-Q	D2.48	LCC250-12DW-X	D2.49
LCC1-56BH-E	D2.44	LCC2-14AWF-Q	D2.54	LCC250-12DWF-X	D2.55
LCC1-56BW-E	D2.48	LCC2-14AWH-Q	D2.51	LCC250-12DWH-X	D2.52
LCC1-56BWF-E	D2.54	LCC2-14B-Q	D2.41	LCC250-12F-X	D2.46
LCC1-56BWH-E	D2.51	LCC2-14BF-Q	D2.45	LCC250-12H-X	D2.44
LCC1-56C-E	D2.41	LCC2-14BH-Q	D2.43	LCC250-12W-X	D2.49
LCC1-56CF-E	D2.46	LCC2-14BW-Q	D2.48	LCC250-12WF-X	D2.55
LCC1-56CH-E	D2.44	LCC2-14BWF-Q	D2.54	LCC250-12WH-X	D2.52
LCC1-56CW-E	D2.48	LCC2-14BWH-Q	D2.51	LCC250-38D-X	D2.42
LCC1-56CWF-E	D2.54	LCC2-14DW-Q	D2.48	LCC250-38DF-X	D2.46
LCC1-56CWH-E	D2.51	LCC2-14DWF-Q	D2.54	LCC250-38DH-X	D2.44
LCC1/0-00-X	D2.57	LCC2-14DWH-Q	D2.51	LCC250-38DW-X	D2.49
LCC1/0-00W-X	D2.58	LCC2-38-Q	D2.41	LCC250-38DWF-X	D2.55
LCC1/0-12-X	D2.42	LCC2-38BW-Q	D2.48	LCC250-38DWH-X	D2.52
LCC1/0-12D-X	D2.42	LCC2-38BWF-Q	D2.54	LCC250-56DW-X	D2.49
LCC1/0-12DF-X	D2.46	LCC2-38BWH-Q	D2.51	LCC250-56DWF-X	D2.55
LCC1/0-12DH-X	D2.44	LCC2-38CW-Q	D2.48	LCC250-56DWH-X	D2.52
LCC1/0-12DW-X	D2.48	LCC2-38CWF-Q	D2.54	LCC3/0-00-X	D2.57
LCC1/0-12DWF-X	D2.54	LCC2-38CWH-Q	D2.51	LCC3/0-00W-X	D2.58
LCC1/0-12DWH-X	D2.51	LCC2-38D-Q	D2.41	LCC3/0-12-X	D2.42
LCC1/0-12F-X	D2.46	LCC2-38DF-Q	D2.45	LCC3/0-12D-X	D2.42
LCC1/0-12H-X	D2.44	LCC2-38DH-Q	D2.43	LCC3/0-12DF-X	D2.46
LCC1/0-12W-X	D2.48	LCC2-38DW-Q	D2.48	LCC3/0-12DH-X	D2.44
LCC1/0-12WF-X	D2.54	LCC2-38DWF-Q	D2.54	LCC3/0-12DW-X	D2.49
LCC1/0-12WH-X	D2.51	LCC2-38DWH-Q	D2.51	LCC3/0-12DWF-X	D2.54
LCC1/0-14A-X	D2.42	LCC2-38F-Q	D2.45	LCC3/0-12DWH-X	D2.51
LCC1/0-14AF-X	D2.46	LCC2-38H-Q	D2.43	LCC3/0-12F-X	D2.46
LCC1/0-14AH-X	D2.44	LCC2-38W-Q	D2.48	LCC3/0-12H-X	D2.44
LCC1/0-14AW-X	D2.48	LCC2-38WF-Q	D2.54	LCC3/0-12W-X	D2.49
LCC1/0-14AWF-X	D2.54	LCC2-38WH-Q	D2.51	LCC3/0-12WF-X	D2.54
LCC1/0-14AWH-X	D2.51	LCC2-56B-Q	D2.41	LCC3/0-12WH-X	D2.51
LCC1/0-14B-X	D2.42	LCC2-56BF-Q	D2.45	LCC3/0-14B-X	D2.42
LCC1/0-14BF-X	D2.46	LCC2-56BH-Q	D2.43	LCC3/0-14BF-X	D2.46
LCC1/0-14BH-X	D2.44	LCC2-56BW-Q	D2.48	LCC3/0-14BH-X	D2.44
LCC1/0-14BW-X	D2.48	LCC2-56BWF-Q	D2.54	LCC3/0-14BW-X	D2.49
LCC1/0-14BWF-X	D2.54	LCC2-56BWH-Q	D2.51	LCC3/0-14BWF-X	D2.54
LCC1/0-14BWH-X	D2.51	LCC2-56C-Q	D2.41	LCC3/0-14BWH-X	D2.51
LCC1/0-14DW-X	D2.48	LCC2-56CF-Q	D2.45	LCC3/0-38D-X	D2.42
LCC1/0-14DWF-X	D2.54	LCC2-56CH-Q	D2.43	LCC3/0-38DF-X	D2.46
LCC1/0-14DWH-X	D2.51	LCC2-56CW-Q	D2.48	LCC3/0-38DH-X	D2.44
LCC1/0-38D-X	D2.42	LCC2-56CWF-Q	D2.54	LCC3/0-38DW-X	D2.49
LCC1/0-38DF-X	D2.46	LCC2-56CWH-Q	D2.51	LCC3/0-38DWF-X	D2.54
LCC1/0-38DH-X	D2.44	LCC2/0-00-X	D2.57	LCC3/0-38DWH-X	D2.51
LCC1/0-38DW-X	D2.48	LCC2/0-00W-X	D2.58	LCC3/0-56DW-X	D2.49
LCC1/0-38DWF-X	D2.54	LCC2/0-12-X	D2.42	LCC3/0-56DWF-X	D2.54
LCC1/0-38DWH-X	D2.51	LCC2/0-12D-X	D2.42	LCC3/0-56DWH-X	D2.51
LCC1/0-38W-X	D2.48	LCC2/0-12DF-X	D2.46	LCC300-00-X	D2.57
LCC1/0-38WF-X	D2.54	LCC2/0-12DH-X	D2.44	LCC300-00W-X	D2.58
LCC1/0-38WH-X	D2.51	LCC2/0-12DW-X	D2.48	LCC300-12-X	D2.42
LCC1/0-56C-X	D2.42	LCC2/0-12DWF-X	D2.54	LCC300-12F-X	D2.46
LCC1/0-56CF-X	D2.46	LCC2/0-12DWH-X	D2.51	LCC300-12H-X	D2.44
LCC1/0-56CH-X	D2.44	LCC2/0-12F-X	D2.46	LCC300-12W-X	D2.49
LCC1/0-56D-X	D2.42	LCC2/0-12H-X	D2.44	LCC300-12WF-X	D2.55
LCC1/0-56DF-X	D2.46	LCC2/0-12W-X	D2.48	LCC300-12WH-X	D2.52
LCC1/0-56DH-X	D2.44	LCC2/0-12WF-X	D2.54	LCC300-38D-X	D2.42
LCC10-14AW-L	D2.47	LCC2/0-12WH-X	D2.51	LCC300-38DF-X	D2.46
LCC10-14AWF-L	D2.53	LCC2/0-14A-X	D2.42	LCC300-38DH-X	D2.44
LCC10-14AWH-L	D2.50	LCC2/0-14AF-X	D2.46	LCC300-38DW-X	D2.49
LCC10-14BW-L	D2.47	LCC2/0-14AH-X	D2.44	LCC300-38DWF-X	D2.55

A. System Overview
B1. Cable Ties
B2. Cable Accessories
B3. Stainless Steel Ties
C1. Wiring Duct
C2. Surface Raceway
C3. Abrasion Protection
C4. Cable Management
D1. Terminals
D2. Power Connectors
D3. Grounding Connectors
E1. Labeling Systems
E2. Labels
E3. Pre-Printed & Write-On Markers
E4. Permanent Identification
E5. Lockout/Tagout & Safety Solutions
F. Index

PANDUIT® ELECTRICAL SOLUTIONS

A. System Overview	Part Number	Page Number	Part Number	Page Number	Part Number	Page Number
B1. Cable Ties	LCC300-38DWH-X	D2.52	LCC4/0-56D-X	D2.42	LCC6-14JWF-L	D2.53
	LCC350-00-X	D2.57	LCC4/0-56DF-X	D2.46	LCC6-14JWH-L	D2.50
	LCC350-00W-X	D2.58	LCC4/0-56DH-X	D2.44	LCC6-14W-L	D2.47
	LCC350-12-X	D2.42	LCC4/0-56DW-X	D2.49	LCC6-38BDW-L	D2.47
	LCC350-12F-X	D2.46	LCC4/0-56DWF-X	D2.54	LCC6-38BW-L	D2.47
B2. Cable Accessories	LCC350-12H-X	D2.44	LCC4/0-56DWH-X	D2.51	LCC6-38BWF-L	D2.53
	LCC350-12W-X	D2.49	LCC400-00-6	D2.57	LCC6-38BWH-L	D2.50
	LCC350-12WF-X	D2.55	LCC400-00W-6	D2.58	LCC6-38CW-L	D2.47
	LCC350-12WH-X	D2.52	LCC400-12-6	D2.42	LCC6-38CWF-L	D2.53
	LCC350-14B-X	D2.42	LCC400-12F-6	D2.46	LCC6-38CWH-L	D2.50
B3. Stainless Steel Ties	LCC350-14BF-X	D2.46	LCC400-12H-6	D2.44	LCC6-38D-L	D2.41
	LCC350-14BH-X	D2.44	LCC400-12W-6	D2.49	LCC6-38DF-L	D2.45
	LCC350-14BW-X	D2.49	LCC400-12WF-6	D2.55	LCC6-38DH-L	D2.43
	LCC350-14BWF-X	D2.55	LCC400-12WH-6	D2.52	LCC6-38DW-L	D2.47
	LCC350-14BWH-X	D2.52	LCC400-14B-6	D2.42	LCC6-38DWF-L	D2.53
C1. Wiring Duct	LCC350-38D-X	D2.42	LCC400-14BF-6	D2.46	LCC6-38DWH-L	D2.50
	LCC350-38DF-X	D2.46	LCC400-14BH-6	D2.44	LCC6-56BW-L	D2.47
	LCC350-38DH-X	D2.44	LCC400-14BW-6	D2.49	LCC6-56BWF-L	D2.53
	LCC350-38DW-X	D2.49	LCC400-14BWF-6	D2.55	LCC6-56BWH-L	D2.50
	LCC350-38DWF-X	D2.55	LCC400-14BWH-6	D2.52	LCC600-00-6	D2.57
C2. Surface Raceway	LCC400-00-L	D2.52	LCC400-38D-6	D2.42	LCC600-00W-6	D2.58
	LCC4-00W-L	D2.57	LCC400-38DF-6	D2.46	LCC600-12-6	D2.42
	LCC4-10AW-L	D2.58	LCC400-38DH-6	D2.44	LCC600-12F-6	D2.46
	LCC4-10AWF-L	D2.48	LCC400-38DW-6	D2.49	LCC600-12H-6	D2.44
	LCC4-10AWH-L	D2.54	LCC400-38DWH-6	D2.55	LCC600-12W-6	D2.49
C3. Abrasion Protection	LCC4-10BW-L	D2.51	LCC500-00-6	D2.52	LCC600-12WF-6	D2.55
	LCC4-10BWF-L	D2.48	LCC500-00W-6	D2.57	LCC600-12WH-6	D2.52
	LCC4-10BWH-L	D2.54	LCC500-12-6	D2.58	LCC600-38D-6	D2.42
	LCC4-12-L	D2.41	LCC500-12F-6	D2.42	LCC600-38DF-6	D2.46
	LCC4-12W-L	D2.48	LCC500-12H-6	D2.46	LCC600-38DH-6	D2.44
C4. Cable Management	LCC4-14A-L	D2.48	LCC500-12W-6	D2.44	LCC600-38DW-6	D2.49
	LCC4-14ADW-L	D2.41	LCC500-12WF-6	D2.49	LCC600-38DWF-6	D2.55
	LCC4-14AF-L	D2.48	LCC500-12WH-6	D2.55	LCC600-38DWH-6	D2.52
	LCC4-14AH-L	D2.45	LCC500-14B-6	D2.52	LCC750-00-6	D2.57
	LCC4-14AW-L	D2.43	LCC500-14BF-6	D2.42	LCC750-12-6	D2.42
D1. Terminals	LCC4-14AWF-L	D2.48	LCC500-14BH-6	D2.46	LCC750-12W-6	D2.49
	LCC4-14AWH-L	D2.54	LCC500-14BWH-6	D2.44	LCC750-38D-6	D2.42
	LCC4-14B-L	D2.51	LCC500-14BW-6	D2.49	LCC750-38DW-6	D2.49
	LCC4-14BF-L	D2.41	LCC500-14BWF-6	D2.55	LCC8-00-L	D2.57
	LCC4-14BH-L	D2.45	LCC500-14BWH-6	D2.52	LCC8-00W-L	D2.58
D2. Power Connectors	LCC4-14BWH-L	D2.43	LCC500-38D-6	D2.42	LCC8-10A-L	D2.41
	LCC4-14BW-L	D2.48	LCC500-38DF-6	D2.46	LCC8-10ABW-L	D2.47
	LCC4-14BWF-L	D2.54	LCC500-38DH-6	D2.44	LCC8-10AF-L	D2.45
	LCC4-14BWH-L	D2.51	LCC500-38DW-6	D2.49	LCC8-10AH-L	D2.43
	LCC4-14DW-L	D2.48	LCC500-38DWF-6	D2.55	LCC8-10AW-L	D2.47
D3. Grounding Connectors	LCC4-38D-L	D2.41	LCC500-38DWH-6	D2.52	LCC8-10AWF-L	D2.53
	LCC4-38DF-L	D2.45	LCC6-00-L	D2.57	LCC8-10AWH-L	D2.50
	LCC4-38DH-L	D2.43	LCC6-00W-L	D2.58	LCC8-10BW-L	D2.47
	LCC4-38DW-L	D2.48	LCC6-10A-L	D2.41	LCC8-10BWF-L	D2.53
	LCC4-38DWF-L	D2.54	LCC6-10ABW-L	D2.47	LCC8-10BWH-L	D2.50
E1. Labeling Systems	LCC4-38DWH-L	D2.51	LCC6-10AF-L	D2.45	LCC8-14A-L	D2.41
	LCC4/0-00-X	D2.57	LCC6-10AH-L	D2.43	LCC8-14ABW-L	D2.47
	LCC4/0-00W-X	D2.58	LCC6-10AW-L	D2.47	LCC8-14AF-L	D2.45
	LCC4/0-12-X	D2.42	LCC6-10AWF-L	D2.53	LCC8-14AH-L	D2.43
	LCC4/0-12D-X	D2.42	LCC6-10AWH-L	D2.50	LCC8-14AW-L	D2.47
E2. Labels	LCC4/0-12DF-X	D2.46	LCC6-10BW-L	D2.47	LCC8-14AWF-L	D2.53
	LCC4/0-12DH-X	D2.44	LCC6-10BWF-L	D2.53	LCC8-14AWH-L	D2.50
	LCC4/0-12DW-X	D2.49	LCC6-10BWH-L	D2.50	LCC8-14B-L	D2.41
	LCC4/0-12DWF-X	D2.54	LCC6-12-L	D2.41	LCC8-14BF-L	D2.45
	LCC4/0-12DWH-X	D2.51	LCC6-12W-L	D2.47	LCC8-14BH-L	D2.43
E3. Pre-Printed & Write-On Markers	LCC4/0-12F-X	D2.46	LCC6-14A-L	D2.41	LCC8-14BW-L	D2.47
	LCC4/0-12H-X	D2.44	LCC6-14AF-L	D2.45	LCC8-14BWF-L	D2.53
	LCC4/0-12W-X	D2.49	LCC6-14AH-L	D2.43	LCC8-14BWH-L	D2.50
	LCC4/0-12WF-X	D2.54	LCC6-14AW-L	D2.47	LCC8-14D-L	D2.41
	LCC4/0-12WH-X	D2.51	LCC6-14AWF-L	D2.53	LCC8-14DF-L	D2.45
E4. Permanent Identification	LCC4/0-14AW-X	D2.49	LCC6-14AWH-L	D2.50	LCC8-14DH-L	D2.43
	LCC4/0-14AWF-X	D2.54	LCC6-14B-L	D2.41	LCC8-14DW-L	D2.47
	LCC4/0-14AWH-X	D2.51	LCC6-14BDW-L	D2.47	LCC8-14DWF-L	D2.53
	LCC4/0-14B-X	D2.42	LCC6-14BF-L	D2.45	LCC8-14DWH-L	D2.50
	LCC4/0-14BF-X	D2.46	LCC6-14BH-L	D2.43	LCC8-38D-L	D2.41
E5. Lockout/Tagout & Safety Solutions	LCC4/0-14BH-X	D2.44	LCC6-14BW-L	D2.47	LCC8-38DF-L	D2.45
	LCC4/0-14BW-X	D2.49	LCC6-14BWF-L	D2.53	LCC8-38DH-L	D2.43
	LCC4/0-14BWF-X	D2.54	LCC6-14BWH-L	D2.50	LCC8-38DW-L	D2.47
	LCC4/0-14BWH-X	D2.51	LCC6-14D-L	D2.41	LCC8-38DWF-L	D2.53
	LCC4/0-38-X	D2.42	LCC6-14DF-L	D2.45	LCC8-38DWH-L	D2.50
F. Index	LCC4/0-38D-X	D2.42	LCC6-14DH-L	D2.43	LCC800-12-6	D2.42
	LCC4/0-38DF-X	D2.46	LCC6-14DW-L	D2.47	LCC800-12W-6	D2.49
	LCC4/0-38DH-X	D2.44	LCC6-14DWF-L	D2.53	LCCF1-12-X	D2.97
	LCC4/0-38DW-X	D2.49	LCC6-14DWH-L	D2.50	LCCF1-12F-X	D2.101
	LCC4/0-38DWF-X	D2.54	LCC6-14EW-L	D2.47	LCCF1-12H-X	D2.99
	LCC4/0-38DWH-X	D2.51	LCC6-14EWF-L	D2.53	LCCF1-14A-X	D2.97
	LCC4/0-38F-X	D2.46	LCC6-14EWH-L	D2.50	LCCF1-14AF-X	D2.101
	LCC4/0-38H-X	D2.44	LCC6-14JAW-L	D2.47	LCCF1-14AH-X	D2.99
	LCC4/0-38W-X	D2.49	LCC6-14JAWF-L	D2.53	LCCF1-14B-X	D2.97
	LCC4/0-38WF-X	D2.54	LCC6-14JAWH-L	D2.50	LCCF1-14BF-X	D2.101
	LCC4/0-38WH-X	D2.51	LCC6-14JW-L	D2.47	LCCF1-14BH-X	D2.99

PANDUIT® ELECTRICAL SOLUTIONS

Part Number	Page Number	Part Number	Page Number	Part Number	Page Number
LCCF1-38D-X	D2.97	LCCF350-38D-6	D2.98	LCCX1-56CF-X	D2.95
LCCF1-38DF-X	D2.101	LCCF350-38DF-6	D2.102	LCCX1-56CH-X	D2.93
LCCF1-38DH-X	D2.99	LCCF350-38DH-6	D2.100	LCCX1-56D-X	D2.92
LCCF1-56C-X	D2.97	LCCF4-14A-L	D2.97	LCCX1-56DF-X	D2.95
LCCF1-56CF-X	D2.101	LCCF4-14AF-L	D2.101	LCCX1-56DH-X	D2.93
LCCF1-56CH-X	D2.99	LCCF4-14AH-L	D2.99	LCCX1/0-12-X	D2.92
LCCF1/0-12-X	D2.98	LCCF4-14B-L	D2.97	LCCX1/0-12F-X	D2.95
LCCF1/0-12F-X	D2.101	LCCF4-14BF-L	D2.101	LCCX1/0-12H-X	D2.94
LCCF1/0-12H-X	D2.99	LCCF4-14BH-L	D2.99	LCCX1/0-14A-X	D2.92
LCCF1/0-14A-X	D2.98	LCCF4-38D-L	D2.97	LCCX1/0-14AF-X	D2.95
LCCF1/0-14AF-X	D2.101	LCCF4-38DH-L	D2.99	LCCX1/0-14AH-X	D2.94
LCCF1/0-14AH-X	D2.99	LCCF4/0-12-X	D2.98	LCCX1/0-14B-X	D2.92
LCCF1/0-14B-X	D2.98	LCCF4/0-12F-X	D2.102	LCCX1/0-14BF-X	D2.95
LCCF1/0-14BF-X	D2.101	LCCF4/0-12H-X	D2.100	LCCX1/0-14BH-X	D2.94
LCCF1/0-14BH-X	D2.99	LCCF4/0-14B-X	D2.98	LCCX1/0-38D-X	D2.92
LCCF1/0-38D-X	D2.98	LCCF4/0-14BF-X	D2.102	LCCX1/0-38DF-X	D2.95
LCCF1/0-38DF-X	D2.101	LCCF4/0-14BH-X	D2.100	LCCX1/0-38DH-X	D2.94
LCCF1/0-38DH-X	D2.99	LCCF4/0-38-X	D2.98	LCCX2-12-E	D2.91
LCCF1/0-56C-X	D2.98	LCCF4/0-38D-X	D2.98	LCCX2-12F-E	D2.95
LCCF1/0-56CF-X	D2.101	LCCF4/0-38DF-X	D2.102	LCCX2-12H-E	D2.93
LCCF1/0-56CH-X	D2.99	LCCF4/0-38DH-X	D2.100	LCCX2-14A-E	D2.91
LCCF2-12-E	D2.97	LCCF4/0-38F-X	D2.102	LCCX2-14AF-E	D2.95
LCCF2-12F-E	D2.101	LCCF4/0-38H-X	D2.100	LCCX2-14AH-E	D2.93
LCCF2-12H-E	D2.99	LCCF400-12-6	D2.98	LCCX2-14B-E	D2.91
LCCF2-14A-E	D2.97	LCCF400-12F-6	D2.102	LCCX2-14BF-E	D2.95
LCCF2-14AH-E	D2.99	LCCF400-12H-6	D2.100	LCCX2-14BH-E	D2.93
LCCF2-14B-E	D2.97	LCCF400-38D-6	D2.98	LCCX2-38D-E	D2.91
LCCF2-14BF-E	D2.101	LCCF400-38DF-6	D2.102	LCCX2-38DF-E	D2.95
LCCF2-14BH-E	D2.99	LCCF400-38DH-6	D2.100	LCCX2-38DH-E	D2.93
LCCF2-38D-E	D2.97	LCCF500-12-6	D2.98	LCCX2/0-12-X	D2.92
LCCF2-38DF-E	D2.101	LCCF500-12F-6	D2.102	LCCX2/0-12F-X	D2.96
LCCF2-38DH-E	D2.99	LCCF500-12H-6	D2.100	LCCX2/0-12H-X	D2.94
LCCF2-56B-E	D2.97	LCCF6-14A-L	D2.97	LCCX2/0-14A-X	D2.92
LCCF2-56BF-E	D2.101	LCCF6-14AF-L	D2.101	LCCX2/0-14AF-X	D2.96
LCCF2-56BH-E	D2.99	LCCF6-14AH-L	D2.99	LCCX2/0-14AH-X	D2.94
LCCF2/0-12-X	D2.98	LCCF6-14B-L	D2.97	LCCX2/0-14B-X	D2.92
LCCF2/0-12F-X	D2.101	LCCF6-14BF-L	D2.101	LCCX2/0-14BF-X	D2.96
LCCF2/0-12H-X	D2.99	LCCF6-14BH-L	D2.99	LCCX2/0-14BH-X	D2.94
LCCF2/0-14A-X	D2.98	LCCF6-38D-L	D2.97	LCCX2/0-38D-X	D2.92
LCCF2/0-14AF-X	D2.101	LCCF6-38DF-L	D2.101	LCCX2/0-38DF-X	D2.96
LCCF2/0-14AH-X	D2.99	LCCF6-38DH-L	D2.99	LCCX2/0-38DH-X	D2.94
LCCF2/0-14B-X	D2.98	LCCF600-12-6	D2.98	LCCX250-14B-X	D2.92
LCCF2/0-14BF-X	D2.101	LCCF600-12F-6	D2.102	LCCX250-14BF-X	D2.96
LCCF2/0-14BH-X	D2.99	LCCF600-12H-6	D2.100	LCCX250-14BH-X	D2.94
LCCF2/0-38D-X	D2.98	LCCF750-12-3	D2.98	LCCX250-38D-X	D2.92
LCCF2/0-38DF-X	D2.101	LCCF750-12F-3	D2.102	LCCX250-38DF-X	D2.96
LCCF2/0-38DH-X	D2.99	LCCF750-12H-3	D2.100	LCCX250-38DH-X	D2.94
LCCF250-12-X	D2.98	LCCF750-38D-3	D2.98	LCCX3/0-14B-X	D2.92
LCCF250-12E-X	D2.98	LCCF750-38DF-3	D2.102	LCCX3/0-14BF-X	D2.96
LCCF250-12EF-X	D2.102	LCCF750-38DH-3	D2.100	LCCX3/0-14BH-X	D2.94
LCCF250-12EH-X	D2.100	LCCF8-14A-L	D2.97	LCCX3/0-38D-X	D2.92
LCCF250-12F-X	D2.102	LCCF8-14AF-L	D2.101	LCCX3/0-38DF-X	D2.96
LCCF250-12H-X	D2.100	LCCF8-14AH-L	D2.99	LCCX3/0-38DH-X	D2.94
LCCF250-14B-X	D2.98	LCCF8-14B-L	D2.97	LCCX300-38D-6	D2.92
LCCF250-14BF-X	D2.102	LCCF8-14BF-L	D2.101	LCCX300-38DF-6	D2.96
LCCF250-14BH-X	D2.100	LCCF8-14BH-L	D2.99	LCCX300-38DH-6	D2.94
LCCF250-38D-X	D2.98	LCCF8-38D-L	D2.97	LCCX350-12-6	D2.92
LCCF250-38DF-X	D2.102	LCCF8-38DF-L	D2.101	LCCX350-12F-6	D2.96
LCCF250-38DH-X	D2.100	LCCF8-38DH-L	D2.99	LCCX350-12H-6	D2.94
LCCF3/0-12-X	D2.98	LCCH1/0-12-X	D2.56	LCCX350-14B-6	D2.92
LCCF3/0-12F-X	D2.101	LCCH1000-12-3	D2.56	LCCX350-14BF-6	D2.96
LCCF3/0-12H-X	D2.99	LCCH2/0-12-X	D2.56	LCCX350-14BH-6	D2.94
LCCF3/0-14B-X	D2.98	LCCH250-12-X	D2.56	LCCX350-38D-6	D2.92
LCCF3/0-14BF-X	D2.101	LCCH3/0-12-X	D2.56	LCCX350-38DF-6	D2.96
LCCF3/0-14BH-X	D2.99	LCCH300-12-X	D2.56	LCCX350-38DH-6	D2.94
LCCF3/0-38D-X	D2.98	LCCH350-12-X	D2.56	LCCX4-14A-L	D2.91
LCCF3/0-38DF-X	D2.101	LCCH4/0-12-X	D2.56	LCCX4-14AB-L	D2.91
LCCF3/0-38DH-X	D2.99	LCCH400-12-6	D2.56	LCCX4-14AF-L	D2.95
LCCF300-12-6	D2.98	LCCH500-12-6	D2.56	LCCX4-14AH-L	D2.93
LCCF300-12F-6	D2.102	LCCH600-12-6	D2.56	LCCX4-14B-L	D2.91
LCCF300-12H-6	D2.100	LCCH750-12-6	D2.56	LCCX4-14BF-L	D2.95
LCCF300-14B-6	D2.98	LCCN750-12W-6	D2.55	LCCX4-14BH-L	D2.93
LCCF300-14BF-6	D2.102	LCCN750-38DW-6	D2.55	LCCX4-38B-L	D2.91
LCCF300-14BH-6	D2.100	LCCX1-14A-X	D2.92	LCCX4-38BD-L	D2.91
LCCF300-38D-6	D2.98	LCCX1-14AF-X	D2.95	LCCX4-38BF-L	D2.95
LCCF300-38DF-6	D2.102	LCCX1-14AH-X	D2.93	LCCX4-38BH-L	D2.93
LCCF300-38DH-6	D2.100	LCCX1-14B-X	D2.92	LCCX4-38D-L	D2.91
LCCF350-12-6	D2.98	LCCX1-14BF-X	D2.95	LCCX4-38DF-L	D2.95
LCCF350-12E-6	D2.98	LCCX1-14BH-X	D2.93	LCCX4-38DH-L	D2.93
LCCF350-12EF-6	D2.102	LCCX1-14D-X	D2.92	LCCX4/0-12-X	D2.92
LCCF350-12EH-6	D2.100	LCCX1-14DF-X	D2.95	LCCX4/0-12F-X	D2.96
LCCF350-12F-6	D2.102	LCCX1-14DH-X	D2.93	LCCX4/0-12H-X	D2.94
LCCF350-12H-6	D2.100	LCCX1-38D-X	D2.92	LCCX4/0-14B-X	D2.92
LCCF350-14B-6	D2.98	LCCX1-38DF-X	D2.95	LCCX4/0-14BF-X	D2.96
LCCF350-14BF-6	D2.102	LCCX1-38DH-X	D2.93	LCCX4/0-14BH-X	D2.94
LCCF350-14BH-6	D2.100	LCCX1-56C-X	D2.92	LCCX4/0-38D-X	D2.92

A.
System
Overview

B1.
Cable Ties

B2.
Cable
Accessories

B3.
Stainless
Steel Ties

C1.
Wiring
Duct

C2.
Surface
Raceway

C3.
Abrasion
Protection

C4.
Cable
Management

D1.
Terminals

D2.
Power
Connectors

D3.
Grounding
Connectors

E1.
Labeling
Systems

E2.
Labels

E3.
Pre-Printed
& Write-On
Markers

E4.
Permanent
Identification

E5.
Lockout/
Tagout
& Safety
Solutions

F.
Index

PANDUIT® ELECTRICAL SOLUTIONS

A. System Overview	Part Number	Page Number	Part Number	Page Number	Part Number	Page Number
B1. Cable Ties	LCCX4/0-38DF-X	D2.96	LCD10-38DF-L	D2.35	LCD4-14AF-L	D2.35
	LCCX4/0-38DH-X	D2.94	LCD10-38DH-L	D2.33	LCD4-14AH-L	D2.33
	LCCX500-12-6	D2.92	LCD1000-00-3	D2.40	LCD4-14B-L	D2.31
	LCCX6-10B-L	D2.91	LCD1000-12-3	D2.32	LCD4-14BF-L	D2.35
	LCCX6-10BF-L	D2.95	LCD1000-12E-3	D2.32	LCD4-14BH-L	D2.33
B2. Cable Accessories	LCCX6-10BH-L	D2.93	LCD2-12-Q	D2.31	LCD4-14D-L	D2.31
	LCCX6-14A-L	D2.91	LCD2-12F-Q	D2.35	LCD4-14DF-L	D2.35
	LCCX6-14AB-L	D2.91	LCD2-12H-Q	D2.34	LCD4-14DH-L	D2.33
	LCCX6-14AF-L	D2.95	LCD2-14A-Q	D2.31	LCD4-38D-L	D2.31
	LCCX6-14AH-L	D2.93	LCD2-14AF-Q	D2.35	LCD4-38DF-L	D2.35
B3. Stainless Steel Ties	LCCX6-14B-L	D2.91	LCD2-14AH-Q	D2.34	LCD4-38DH-L	D2.33
	LCCX6-14BF-L	D2.95	LCD2-14B-Q	D2.31	LCD4/0-00-X	D2.40
	LCCX6-14BH-L	D2.93	LCD2-14BF-Q	D2.35	LCD4/0-12-X	D2.32
	LCCX6-14D-L	D2.91	LCD2-14BH-Q	D2.34	LCD4/0-12F-X	D2.36
	LCCX6-14DF-L	D2.95	LCD2-14D-Q	D2.31	LCD4/0-12H-X	D2.34
C1. Wiring Duct	LCCX6-14DH-L	D2.93	LCD2-14DF-Q	D2.35	LCD4/0-14B-X	D2.32
	LCCX6-38A-L	D2.91	LCD2-14DH-Q	D2.34	LCD4/0-14BF-X	D2.36
	LCCX6-38AC-L	D2.91	LCD2-38D-Q	D2.31	LCD4/0-14BH-X	D2.34
	LCCX6-38AF-L	D2.95	LCD2-38DF-Q	D2.35	LCD4/0-38D-X	D2.32
	LCCX6-38AH-L	D2.93	LCD2-38DH-Q	D2.34	LCD4/0-38DF-X	D2.36
C2. Surface Raceway	LCCX6-38C-L	D2.91	LCD2-56B-Q	D2.31	LCD4/0-38DH-X	D2.34
	LCCX6-38CF-L	D2.95	LCD2-56BF-Q	D2.35	LCD400-00-6	D2.40
	LCCX6-38CH-L	D2.93	LCD2-56BH-Q	D2.34	LCD400-12-6	D2.32
	LCCX6-38D-L	D2.91	LCD2/0-00-X	D2.40	LCD400-12F-6	D2.36
	LCCX6-38DF-L	D2.95	LCD2/0-12-X	D2.32	LCD400-12H-6	D2.34
C3. Abrasion Protection	LCCX6-38DH-L	D2.93	LCD2/0-12F-X	D2.36	LCD400-38D-6	D2.32
	LCCX8-10A-L	D2.91	LCD2/0-12H-X	D2.34	LCD400-38DF-6	D2.36
	LCCX8-10AB-L	D2.91	LCD2/0-14A-X	D2.32	LCD400-38DH-6	D2.34
	LCCX8-10AF-L	D2.95	LCD2/0-14AF-X	D2.36	LCD500-00-6	D2.40
	LCCX8-10AH-L	D2.93	LCD2/0-14AH-X	D2.34	LCD500-12-6	D2.32
C4. Cable Management	LCCX8-10B-L	D2.91	LCD2/0-14B-X	D2.32	LCD500-12E-6	D2.32
	LCCX8-10BF-L	D2.95	LCD2/0-14BF-X	D2.36	LCD500-12EF-6	D2.36
	LCCX8-10BH-L	D2.93	LCD2/0-14BH-X	D2.34	LCD500-12EH-6	D2.34
	LCCX8-14A-L	D2.91	LCD2/0-38D-X	D2.32	LCD500-12F-6	D2.36
	LCCX8-14AB-L	D2.91	LCD2/0-38DF-X	D2.36	LCD500-12H-6	D2.34
D1. Terminals	LCCX8-14AF-L	D2.95	LCD2/0-38DH-X	D2.34	LCD500-14B-6	D2.32
	LCCX8-14AH-L	D2.93	LCD2/0-56C-X	D2.32	LCD500-14BF-6	D2.36
	LCCX8-14B-L	D2.91	LCD2/0-56CF-X	D2.36	LCD500-14BH-6	D2.34
	LCCX8-14BF-L	D2.95	LCD2/0-56CH-X	D2.34	LCD500-38D-6	D2.32
	LCCX8-14BH-L	D2.93	LCD250-00-X	D2.40	LCD500-38DF-6	D2.36
D2. Power Connectors	LCCX8-14D-L	D2.91	LCD250-12-X	D2.32	LCD500-38DH-6	D2.34
	LCCX8-14DF-L	D2.95	LCD250-12F-X	D2.36	LCD6-10A-L	D2.31
	LCCX8-14DH-L	D2.93	LCD250-12H-X	D2.34	LCD6-10AF-L	D2.35
	LCCX8-38D-L	D2.91	LCD250-38D-X	D2.32	LCD6-10AH-L	D2.33
	LCCX8-38DF-L	D2.95	LCD250-38DF-X	D2.36	LCD6-10B-L	D2.31
D3. Grounding Connectors	LCCX8-38DH-L	D2.93	LCD250-38DH-X	D2.34	LCD6-10BF-L	D2.35
	LCD1-12-E	D2.32	LCD3/0-00-X	D2.40	LCD6-10BH-L	D2.33
	LCD1-12F-E	D2.36	LCD3/0-12-X	D2.32	LCD6-10D-L	D2.31
	LCD1-12H-E	D2.34	LCD3/0-12F-X	D2.36	LCD6-10DF-L	D2.35
	LCD1-14A-E	D2.32	LCD3/0-12H-X	D2.34	LCD6-10DH-L	D2.33
E1. Labeling Systems	LCD1-14AF-E	D2.36	LCD3/0-14B-X	D2.32	LCD6-14A-L	D2.31
	LCD1-14AH-E	D2.34	LCD3/0-14BF-X	D2.36	LCD6-14AF-L	D2.35
	LCD1-14B-E	D2.32	LCD3/0-14BH-X	D2.34	LCD6-14AH-L	D2.33
	LCD1-14BF-E	D2.36	LCD3/0-38D-X	D2.32	LCD6-14B-L	D2.31
	LCD1-14BH-E	D2.34	LCD3/0-38DF-X	D2.36	LCD6-14BF-L	D2.35
E2. Labels	LCD1-38D-E	D2.32	LCD3/0-38DFH-X	D2.34	LCD6-14BH-L	D2.33
	LCD1-38DF-E	D2.36	LCD3/0-56D-X	D2.32	LCD6-14D-L	D2.31
	LCD1-38DH-E	D2.34	LCD3/0-56DF-X	D2.36	LCD6-14DF-L	D2.35
	LCD1-56C-E	D2.32	LCD3/0-56DH-X	D2.34	LCD6-14DH-L	D2.33
	LCD1-56CF-E	D2.36	LCD300-00-X	D2.40	LCD6-38D-L	D2.31
E3. Pre-Printed & Write-On Markers	LCD1-56CH-E	D2.34	LCD300-12-X	D2.32	LCD6-38DF-L	D2.35
	LCD1/0-00-X	D2.40	LCD300-12F-X	D2.36	LCD6-38DH-L	D2.33
	LCD1/0-12-X	D2.32	LCD300-12H-X	D2.34	LCD6-56D-L	D2.31
	LCD1/0-12F-X	D2.36	LCD300-38D-X	D2.32	LCD6-56DF-L	D2.35
	LCD1/0-12H-X	D2.34	LCD300-38DF-X	D2.36	LCD6-56DH-L	D2.33
E4. Permanent Identification	LCD1/0-14A-X	D2.32	LCD300-38DH-X	D2.34	LCD600-00-6	D2.40
	LCD1/0-14AF-X	D2.36	LCD350-00-X	D2.40	LCD600-12-6	D2.32
	LCD1/0-14AH-X	D2.34	LCD350-12-X	D2.32	LCD600-12F-6	D2.36
	LCD1/0-14B-X	D2.32	LCD350-12E-X	D2.32	LCD600-12H-6	D2.34
	LCD1/0-14BF-X	D2.36	LCD350-12EF-X	D2.36	LCD600-38D-6	D2.32
E5. Lockout/Tagout & Safety Solutions	LCD1/0-14BH-X	D2.34	LCD350-12EH-X	D2.34	LCD600-38DF-6	D2.36
	LCD1/0-38D-X	D2.32	LCD350-12F-X	D2.36	LCD600-38DH-6	D2.34
	LCD1/0-38DF-X	D2.36	LCD350-12H-X	D2.34	LCD750-00-6	D2.40
	LCD1/0-38DH-X	D2.34	LCD350-14B-X	D2.32	LCD750-12-6	D2.32
	LCD1/0-56C-X	D2.32	LCD350-14BF-X	D2.36	LCD750-38D-6	D2.32
F. Index	LCD1/0-56CF-X	D2.36	LCD350-14BH-X	D2.34	LCD750-58G-6	D2.32
	LCD1/0-56CH-X	D2.34	LCD350-38D-X	D2.32	LCD8-10A-L	D2.31
	LCD10-10A-L	D2.31	LCD350-38DF-X	D2.36	LCD8-10AF-L	D2.35
	LCD10-10AF-L	D2.35	LCD350-38DH-X	D2.34	LCD8-10AH-L	D2.33
	LCD10-10AH-L	D2.33	LCD4-10A-L	D2.31	LCD8-14A-L	D2.31
				LCD4-10AF-L	D2.35	
				LCD4-10AH-L	D2.33	
				LCD4-10B-L	D2.31	
				LCD4-10BF-L	D2.35	
				LCD4-10BH-L	D2.33	
				LCD4-14A-L	D2.31	

PANDUIT® ELECTRICAL SOLUTIONS

Part Number	Page Number	Part Number	Page Number	Part Number	Page Number
LCD8-14DF-L	D2.35	LCDX2-56D-E	D2.83	LCDX4/0-12EF-X	D2.88
LCD8-14DH-L	D2.33	LCDX2-56DF-E	D2.87	LCDX4/0-12EH-X	D2.86
LCD8-38D-L	D2.31	LCDX2-56DH-E	D2.85	LCDX4/0-12F-X	D2.88
LCD8-38DF-L	D2.35	LCDX2/0-12-X	D2.84	LCDX4/0-12H-X	D2.86
LCD8-38DH-L	D2.33	LCDX2/0-12D-X	D2.84	LCDX4/0-14A-X	D2.84
LCDN1-14B-E	D2.37	LCDX2/0-12DF-X	D2.88	LCDX4/0-14AF-X	D2.88
LCDN1/0-14D-X	D2.37	LCDX2/0-12DH-X	D2.86	LCDX4/0-14AH-X	D2.86
LCDN1/0-14DF-X	D2.39	LCDX2/0-12F-X	D2.88	LCDX4/0-14B-X	D2.84
LCDN1/0-14DH-X	D2.38	LCDX2/0-12H-X	D2.86	LCDX4/0-14BF-X	D2.88
LCDN1/0-56D-X	D2.37	LCDX2/0-14A-X	D2.84	LCDX4/0-14BH-X	D2.86
LCDN1/0-56DF-X	D2.39	LCDX2/0-14AF-X	D2.88	LCDX4/0-38D-X	D2.84
LCDN1/0-56DH-X	D2.38	LCDX2/0-14AH-X	D2.86	LCDX4/0-38DF-X	D2.88
LCDN2-14A-Q	D2.37	LCDX2/0-14B-X	D2.84	LCDX4/0-38DH-X	D2.86
LCDN2-14AF-Q	D2.39	LCDX2/0-14BF-X	D2.88	LCDX4/0-56D-X	D2.84
LCDN2-14AH-Q	D2.38	LCDX2/0-14BH-X	D2.86	LCDX4/0-56DF-X	D2.88
LCDN2-14B-Q	D2.37	LCDX2/0-38D-X	D2.84	LCDX4/0-56DH-X	D2.86
LCDN2-14D-Q	D2.37	LCDX2/0-38DF-X	D2.88	LCDX450-12-6	D2.84
LCDN2-14DF-Q	D2.39	LCDX2/0-38DH-X	D2.86	LCDX450-12F-6	D2.88
LCDN2-14DH-Q	D2.38	LCDX2/0-56D-X	D2.84	LCDX450-12H-6	D2.86
LCDN2/0-14A-X	D2.37	LCDX2/0-56DF-X	D2.88	LCDX450-38D-6	D2.84
LCDN2/0-14D-X	D2.37	LCDX2/0-56DH-X	D2.86	LCDX450-38DF-6	D2.88
LCDN2/0-56A-X	D2.37	LCDX250-12-X	D2.84	LCDX450-38DH-6	D2.86
LCDN2/0-56D-X	D2.37	LCDX250-12E-X	D2.84	LCDX500-12-6	D2.84
LCDN350-38D-X	D2.37	LCDX250-12EF-X	D2.88	LCDX500-12E-6	D2.84
LCDN500-12D-6	D2.37	LCDX250-12EH-X	D2.86	LCDX500-12EF-6	D2.88
LCDN500-38D-6	D2.37	LCDX250-12F-X	D2.88	LCDX500-12EH-6	D2.86
LCDN750-12D-6	D2.37	LCDX250-12H-X	D2.86	LCDX500-12F-6	D2.88
LCDN750-12DF-6	D2.39	LCDX250-38-X	D2.84	LCDX500-12H-6	D2.86
LCDN750-12DH-6	D2.38	LCDX250-38D-X	D2.84	LCDX500-38D-6	D2.84
LCDN750-38D-6	D2.37	LCDX250-38DF-X	D2.88	LCDX500-38DF-6	D2.88
LCDN750-38DF-6	D2.39	LCDX250-38DH-X	D2.86	LCDX500-38DH-6	D2.86
LCDN750-38DH-6	D2.38	LCDX250-38F-X	D2.88	LCDX500-56D-6	D2.84
LCDX1-12-X	D2.83	LCDX250-38H-X	D2.86	LCDX500-56DF-6	D2.88
LCDX1-12F-X	D2.87	LCDX3/0-12-X	D2.84	LCDX500-56DH-6	D2.86
LCDX1-12H-X	D2.85	LCDX3/0-12F-X	D2.88	LCDX6-10A-L	D2.83
LCDX1-14A-X	D2.83	LCDX3/0-12H-X	D2.86	LCDX6-10AF-L	D2.87
LCDX1-14AF-X	D2.87	LCDX3/0-14A-X	D2.84	LCDX6-10AH-L	D2.85
LCDX1-14AH-X	D2.85	LCDX3/0-14AF-X	D2.88	LCDX6-10B-L	D2.83
LCDX1-14B-X	D2.83	LCDX3/0-14AH-X	D2.86	LCDX6-10BF-L	D2.87
LCDX1-14BF-X	D2.87	LCDX3/0-38D-X	D2.84	LCDX6-10BH-L	D2.85
LCDX1-14BH-X	D2.85	LCDX3/0-38DF-X	D2.88	LCDX6-10G-L	D2.83
LCDX1-14D-X	D2.83	LCDX3/0-38DH-X	D2.86	LCDX6-10GF-L	D2.87
LCDX1-14DF-X	D2.87	LCDX3/0-56D-X	D2.84	LCDX6-10GH-L	D2.85
LCDX1-14DH-X	D2.85	LCDX3/0-56DF-X	D2.88	LCDX6-10P-L	D2.83
LCDX1-38D-X	D2.83	LCDX3/0-56DH-X	D2.86	LCDX6-10PF-L	D2.87
LCDX1-38DF-X	D2.87	LCDX300-12-6	D2.84	LCDX6-10PH-L	D2.85
LCDX1-38DH-X	D2.85	LCDX300-12F-6	D2.88	LCDX6-14A-L	D2.83
LCDX1-56D-X	D2.83	LCDX300-12H-6	D2.86	LCDX6-14AF-L	D2.87
LCDX1-56DF-X	D2.87	LCDX300-38D-6	D2.84	LCDX6-14AH-L	D2.85
LCDX1-56DH-X	D2.85	LCDX300-38DF-6	D2.88	LCDX6-14B-L	D2.83
LCDX1/0-12-X	D2.84	LCDX300-38DH-6	D2.86	LCDX6-14BF-L	D2.87
LCDX1/0-12D-X	D2.84	LCDX350-12-6	D2.84	LCDX6-14BH-L	D2.85
LCDX1/0-12DF-X	D2.88	LCDX350-12E-6	D2.84	LCDX6-14D-L	D2.83
LCDX1/0-12DH-X	D2.86	LCDX350-12EF-6	D2.88	LCDX6-14DF-L	D2.87
LCDX1/0-12F-X	D2.88	LCDX350-12EH-6	D2.86	LCDX6-14DH-L	D2.85
LCDX1/0-12H-X	D2.86	LCDX350-12F-6	D2.88	LCDX6-38D-L	D2.83
LCDX1/0-14A-X	D2.84	LCDX350-12H-6	D2.86	LCDX6-38DF-L	D2.87
LCDX1/0-14AF-X	D2.88	LCDX350-38-6	D2.84	LCDX6-38DH-L	D2.85
LCDX1/0-14AH-X	D2.86	LCDX350-38D-6	D2.84	LCDX6-56D-L	D2.83
LCDX1/0-14B-X	D2.84	LCDX350-38DF-6	D2.88	LCDX6-56DF-L	D2.87
LCDX1/0-14BF-X	D2.88	LCDX350-38DH-6	D2.86	LCDX6-56DH-L	D2.85
LCDX1/0-14BH-X	D2.86	LCDX350-38F-6	D2.88	LCDX600-12-6	D2.84
LCDX1/0-38D-X	D2.84	LCDX350-38H-6	D2.86	LCDX600-12F-6	D2.88
LCDX1/0-38DF-X	D2.88	LCDX350-56D-6	D2.84	LCDX600-12H-6	D2.86
LCDX1/0-38DH-X	D2.86	LCDX350-56DF-6	D2.88	LCDX650-12-6	D2.84
LCDX1/0-56B-X	D2.84	LCDX350-56DH-6	D2.86	LCDX650-12F-6	D2.88
LCDX1/0-56BF-X	D2.88	LCDX4-14A-L	D2.83	LCDX650-12H-6	D2.86
LCDX1/0-56BH-X	D2.86	LCDX4-14AF-L	D2.87	LCDX650-38D-6	D2.84
LCDX1/0-56D-X	D2.84	LCDX4-14AH-L	D2.85	LCDX650-38DF-6	D2.88
LCDX1/0-56DF-X	D2.88	LCDX4-14B-L	D2.83	LCDX650-38DH-6	D2.86
LCDX1/0-56DH-X	D2.86	LCDX4-14BF-L	D2.87	LCDX750-12-3	D2.84
LCDX2-12-E	D2.83	LCDX4-14BH-L	D2.85	LCDX750-12E-3	D2.84
LCDX2-12F-E	D2.87	LCDX4-14D-L	D2.83	LCDX750-12EF-3	D2.88
LCDX2-12H-E	D2.85	LCDX4-14DF-L	D2.87	LCDX750-12EH-3	D2.86
LCDX2-14A-E	D2.83	LCDX4-14DH-L	D2.85	LCDX750-12F-3	D2.88
LCDX2-14AF-E	D2.87	LCDX4-38D-L	D2.83	LCDX750-12G-3	D2.84
LCDX2-14AH-E	D2.85	LCDX4-38DF-L	D2.87	LCDX750-12GF-3	D2.88
LCDX2-14B-E	D2.83	LCDX4-38DH-L	D2.85	LCDX750-12GH-3	D2.86
LCDX2-14BF-E	D2.87	LCDX4-56D-L	D2.83	LCDX750-12H-3	D2.86
LCDX2-14BH-E	D2.85	LCDX4-56DF-L	D2.87	LCDX750-38D-3	D2.84
LCDX2-14D-E	D2.83	LCDX4-56DH-L	D2.85	LCDX750-38DF-3	D2.88
LCDX2-14DF-E	D2.87	LCDX4/0-12-X	D2.84	LCDX750-38DH-3	D2.86
LCDX2-14DH-E	D2.85	LCDX4/0-12D-X	D2.84	LCDX750-58G-3	D2.84
LCDX2-38D-E	D2.83	LCDX4/0-12DF-X	D2.88	LCDX750-58GF-3	D2.88
LCDX2-38DF-E	D2.87	LCDX4/0-12DH-X	D2.86	LCDX750-58GH-3	D2.86
LCDX2-38DH-E	D2.85	LCDX4/0-12E-X	D2.84	LCDX8-10A-L	D2.83

A. System Overview

B1. Cable Ties

B2. Cable Accessories

B3. Stainless Steel Ties

C1. Wiring Duct

C2. Surface Raceway

C3. Abrasion Protection

C4. Cable Management

D1. Terminals

D2. Power Connectors

D3. Grounding Connectors

E1. Labeling Systems

E2. Labels

E3. Pre-Printed & Write-On Markers

E4. Permanent Identification

E5. Lockout/Tagout & Safety Solutions

F. Index

PANDUIT® ELECTRICAL SOLUTIONS

A. System Overview	Part Number	Page Number	Part Number	Page Number	Part Number	Page Number
B1. Cable Ties	LCDX8-10AF-L	D2.87	LCMD120-00-X	D2.110	LPMM-S2-C	B2.13
	LCDX8-10AH-L	D2.85	LCMD120-10CD-X	D2.110	LPMM-S5-C	B2.13
	LCDX8-14A-L	D2.83	LCMD120-12-X	D2.110	LPMS-S8-C	B2.13
	LCDX8-14AF-L	D2.87	LCMD120-14-X	D2.110	LS8-CASE	E1.2
B2. Cable Accessories	LCDX8-14AH-L	D2.85	LCMD150-00-X	D2.110	LS8-CLN	E1.2
	LCDX8-14B-L	D2.83	LCMD150-10CD-X	D2.110	LS8-IB	E1.2
	LCDX8-14BF-L	D2.87	LCMD150-12-X	D2.110	LS8-PCKIT	E1.2
	LCDX8-14BH-L	D2.85	LCMD150-14-X	D2.110	LS8-WS	E1.2
	LCDX8-14D-L	D2.83	LCMD16-00-Q	D2.110	LS8E	E1.2
	LCDX8-14DF-L	D2.87	LCMD16-6CD-Q	D2.110	LS8E-ACS	E1.2
	LCDX8-14DH-L	D2.85	LCMD16-8-Q	D2.110	LS8E-KIT	E1.2
	LCDX8-38D-L	D2.83	LCMD185-00-X	D2.111	LS9	E1.2
	LCDX8-38DF-L	D2.87	LCMD185-10CD-X	D2.111	LS9-ACS	E1.2
	LCDX8-38DH-L	D2.85	LCMD185-12-X	D2.111	LS9-CASE	E1.2
B3. Stainless Steel Ties	LCDXN2-14A-E	D2.89	LCMD185-14-X	D2.111	LS9-CLN	E1.2
	LCDXN350-38D-6	D2.89	LCMD240-00-5	D2.111	LS9-IB	E1.2
	LCDXN4/0-38D-X	D2.89	LCMD240-10CD-5	D2.111	LS9-WS	E1.2
	LCDXN500-38D-6	D2.89	LCMD240-12-5	D2.111	LTYPK	D3.5
C1. Wiring Duct	LCDXN750-12-3	D2.89	LCMD240-14-5	D2.111	LWC100-A-L	B2.34
	LCDXN750-38D-3	D2.89	LCMD25-00-Q	D2.110	LWC100-A-L14	B2.34
	LCDXN750-38DF-3	D2.90	LCMD25-10-Q	D2.110	LWC100-A-L20	B2.34
	LCDXN750-38DH-3	D2.90	LCMD25-12-Q	D2.110	LWC100-H25-L	B2.34
C2. Surface Raceway	LCMA10-10-C	D2.109	LCMD25-8-Q	D2.110	LWC100-H25-L14	B2.34
	LCMA10-5-C	D2.109	LCMD25-8CD-Q	D2.110	LWC100-H25-L20	B2.34
	LCMA10-6-C	D2.109	LCMD300-00-5	D2.111	LWC19-A-C	B2.34
	LCMA10-8-C	D2.109	LCMD300-12-5	D2.111	LWC19-A-C14	B2.34
	LCMA120-10-L	D2.109	LCMD300-14-5	D2.111	LWC19-A-C20	B2.34
	LCMA120-12-L	D2.109	LCMD35-00-Q	D2.110	LWC19-H25-C	B2.34
	LCMA120-16-L	D2.109	LCMD35-10-Q	D2.110	LWC19-H25-C14	B2.34
	LCMA120-8-L	D2.109	LCMD35-12-Q	D2.110	LWC25-A-C	B2.34
	LCMA150-10-X	D2.109	LCMD35-8CD-Q	D2.110	LWC25-A-C14	B2.34
	LCMA150-12-X	D2.109	LCMD400-00-5	D2.111	LWC25-A-C20	B2.34
C3. Abrasion Protection	LCMA150-16-X	D2.109	LCMD400-12-5	D2.111	LWC25-H25-C	B2.34
	LCMA150-20-X	D2.109	LCMD400-14-5	D2.111	LWC25-H25-C14	B2.34
	LCMA150-8-X	D2.109	LCMD400-16-5	D2.111	LWC25-H25-C20	B2.34
	LCMA16-10-C	D2.109	LCMD50-00-X	D2.110	LWC38-A-C	B2.34
	LCMA16-5-C	D2.109	LCMD50-10-X	D2.110	LWC38-A-C14	B2.34
	LCMA16-6-C	D2.109	LCMD50-10CD-X	D2.110	LWC38-A-C20	B2.34
	LCMA16-8-C	D2.109	LCMD50-12-X	D2.110	LWC38-H25-C	B2.34
	LCMA185-10-X	D2.109	LCMD500-00-1	D2.111	LWC38-H25-C14	B2.34
	LCMA185-12-X	D2.109	LCMD500-12-1	D2.111	LWC38-H25-C20	B2.34
	LCMA185-16-X	D2.109	LCMD500-14-1	D2.111	LWC50-A-L	B2.34
C4. Cable Management	LCMA185-20-X	D2.109	LCMD500-16-1	D2.111	LWC50-A-L14	B2.34
	LCMA240-10-X	D2.109	LCMD6-5CD-Q	D2.110	LWC50-A-L20	B2.34
	LCMA240-12-X	D2.109	LCMD630-00-1	D2.111	LWC50-H25-L	B2.34
	LCMA240-16-X	D2.109	LCMD630-12-1	D2.111	LWC50-H25-L14	B2.34
	LCMA240-20-X	D2.109	LCMD630-14-1	D2.111	LWC50-H25-L20	B2.34
	LCMA25-10-C	D2.109	LCMD630-16-1	D2.111	LWC75-A-L	B2.34
	LCMA25-6-C	D2.109	LCMD70-00-X	D2.110	LWC75-A-L14	B2.34
	LCMA25-8-C	D2.109	LCMD70-10-X	D2.110	LWC75-A-L20	B2.34
	LCMA300-10-5	D2.109	LCMD70-10CD-X	D2.110	LWC75-H25-L	B2.34
	LCMA300-12-5	D2.109	LCMD70-12-X	D2.110	LWC75-H25-L14	B2.34
D1. Terminals	LCMA300-16-5	D2.109	LCMD95-00-X	D2.110	LWC75-H25-L20	B2.34
	LCMA300-20-5	D2.109	LCMD95-10CD-X	D2.110		
	LCMA35-10-C	D2.109	LCMD95-12-X	D2.110		
	LCMA35-12-C	D2.109	LCMD95-14-X	D2.110		
	LCMA35-6-C	D2.109	LD10IW10-A	C2.76	M200X050Y6T	E2.9
	LCMA35-8-C	D2.109	LD10IW6-A	C2.76	M200X050Y7T	E2.9
	LCMA400-12-5	D2.109	LD10IW8-A	C2.76	M200X100Y6T	E2.9
	LCMA400-16-5	D2.109	LD2P10IW10-A	C2.75	M200X100Y7T	E2.9
	LCMA400-20-5	D2.109	LD2P10IW8-A	C2.75	M300X050Y6T	E2.9
	LCMA50-10-L	D2.109	LD3IW10-A	C2.76	M300X050Y7T	E2.9
D2. Power Connectors	LCMA50-12-L	D2.109	LD3IW6-A	C2.76	M300X100Y6T	E2.9
	LCMA50-6-L	D2.109	LD3IW8-A	C2.76	M300X100Y7T	E2.9
	LCMA50-8-L	D2.109	LD5IW10-A	C2.76	MACC25-A-C	B2.33
	LCMA500-00-1	D2.109	LD5IW6-A	C2.76	MACC62-A-C	B2.33
	LCMA500-12-1	D2.109	LD5IW8-A	C2.76	MBCEH-QR316	B3.13
	LCMA500-16-1	D2.109	LDPH10IW10-A	C2.77	MBCH-QR316	B3.12
	LCMA500-20-1	D2.109	LDPH10IW8-A	C2.77	MBCSH-QR316	B3.13
	LCMA6-5-C	D2.108	LDPH3IW10-A	C2.77	MBEH-TLR	B3.12
	LCMA6-6-C	D2.108	LDPH3IW8-A	C2.77	MBEH-TLR316	B3.12
	LCMA6-8-C	D2.108	LDPH5IW10-A	C2.77	MBH-MR	B3.12
D3. Grounding Connectors	LCMA630-00-1	D2.109	LDPH5IW8-A	C2.77	MBH-MR316	B3.12
	LCMA630-16-1	D2.109	LDS3IW10-A	C2.78	MBH-TLR	B3.12
	LCMA630-20-1	D2.109	LDS5IW10-A	C2.78	MBH-TLR316	B3.12
	LCMA70-10-L	D2.109	LHMS-S10-D	B2.17	MBM-H25-Q	B3.28
	LCMA70-12-L	D2.109	LHMS-S5-D	B2.17	MBMS-S10-CY	B2.18
	LCMA70-6-L	D2.109	LHMS-S6-D	B2.17	MBS-MR	B3.12
	LCMA70-8-L	D2.109	LI-112S-L	D3.21	MBS-MR316	B3.12
	LCMA95-10-L	D2.109	LI-252S-Q	D3.21	MBS-TLR	B3.12
	LCMA95-12-L	D2.109	LI-50S-C	D3.21	MBS-TLR316	B3.12
	LCMA95-16-L	D2.109	LMD3IW-Q	C2.78	MBSH-TR	B3.12
E1. Labeling Systems	LCMA95-8-L	D2.109	LMD5IW-Q	C2.78	MBSH-TR316	B3.12
	LCMA95-8-L	D2.109	LPFCM14-A-C14	B2.37	MC100X100IG2	C1.15
	LCMA95-10-L	D2.109	LPFCM22-A-C14	B2.37	MC100X50IG2	C1.15
	LCMA95-12-L	D2.109	LPFCM34-A-C14	B2.37	MC100X62IG2	C1.15
	LCMA95-16-L	D2.109				
	LCMA95-8-L	D2.109				
	LCMD10-00-Q	D2.110				
	LCMD10-6CD-Q	D2.110				
	LCMD10-8-Q	D2.110				
	E2. Labels					
E3. Pre-Printed & Write-On Markers						
E4. Permanent Identification						
E5. Lockout/Tagout & Safety Solutions						
F. Index						

M

PANDUIT® ELECTRICAL SOLUTIONS

Part Number	Page Number	Part Number	Page Number	Part Number	Page Number
MC100X75IG2	C1.15	MLT4DH-L	B3.11	MMP350DB-C	E4.3
MC25X25IG2	C1.15	MLT4DSH-Q	B3.11	MMP350DB-C316	E4.3
MC25X37IG2	C1.15	MLT4DSH-Q316	B3.11	MMP350H-C	E4.3
MC25X50IG2	C1.15	MLT4EH-LP	B3.6	MMP350H-C316	E4.3
MC25X62IG2	C1.15	MLT4EH-LP316	B3.7	MMP350H-CAL	E4.5
MC25X75IG2	C1.15	MLT4EH15-LP	B3.6	MMP350H-CALBL	E4.5
MC37X37IG2	C1.15	MLT4EH15-LP316	B3.7	MMP350H-CALBU	E4.5
MC37X50IG2	C1.15	MLT4H-LP	B3.6	MMP350H-CALGR	E4.5
MC37X62IG2	C1.15	MLT4H-LP316	B3.7	MMP350H-CALRD	E4.5
MC37X75IG2	C1.15	MLT4H-LPAL	B3.10	MMP350H-CALYL	E4.5
MC50X100IG2	C1.15	MLT4H-LPALBL	B3.10	MMP350W17-Q	E4.3
MC50X50IG2	C1.15	MLT4H-LPALBU	B3.10	MMP350W38-C	E4.3
MC50X75IG2	C1.15	MLT4H-LPALGR	B3.10	MMP350W38-C316	E4.3
MC62X37IG2	C1.15	MLT4H-LPALRD	B3.10	MP150-C	B2.29
MC62X62IG2	C1.15	MLT4H-LPALYL	B3.10	MP150-C0	B2.29
MC75X100IG2	C1.15	MLT4LH-LP	B3.6	MP150-R	B2.29
MC75X50IG2	C1.15	MLT4LH-LP316	B3.6	MP175-C	B2.29
MC75X62IG2	C1.15	MLT4S-CP	B3.5	MP175-C0	B2.29
MC75X75IG2	C1.15	MLT4S-CP316	B3.6	MP175-R	B2.29
MCEH-S25-C0	B1.24	MLT4S-L	B3.5	MP1G106WH	C2.17
MCMS12-P-C	B2.18	MLT4SH-LP	B3.6	MP1GBWH	C2.17
MCMS25-P-C	B2.18	MLT4SH-LP316	B3.7	MP1GRWH	C2.17
MCMS30-P-C	B2.18	MLT5DH-L	B3.11	MP1TSWH	C2.17
MEHT	E4.5	MLT6DEH-Q	B3.11	MP200-C	B2.29
META-X	E4.5	MLT6DEH-Q316	B3.11	MP200-C0	B2.29
METS3-X	E4.5	MLT6DEH15-Q	B3.11	MP200-R	B2.29
METS4-X	E4.5	MLT6DEH15-Q316	B3.11	MP250-C	B2.29
MIM094	E4.6	MLT6DH-Q	B3.11	MP250-C0	B2.29
MIM125	E4.6	MLT6DSH-Q	B3.11	MP250-R	B2.29
MIM187	E4.6	MLT6DSH-Q316	B3.11	MP250W175-C	B2.29
MIW094	E4.6	MLT6EH-LP	B3.6	MP2G106BWH	C2.17
MIW125	E4.6	MLT6EH-LP316	B3.7	MP2G106RWH	C2.17
MIW187	E4.6	MLT6EH15-LP	B3.6	MP2G106TWH	C2.17
ML10-O-LY	D2.134	MLT6EH15-LP316	B3.7	MP2G106WH	C2.17
ML10T-LY	D2.135	MLT6H-LP	B3.6	MP2GBWH	C2.17
ML250-QY	D2.134	MLT6H-LP316	B3.7	MP2GRBWH	C2.17
ML250T-Qy	D2.135	MLT6LH-LP	B3.6	MP2GRTSWH	C2.17
ML4-CY	D2.134	MLT6LH-LP316	B3.6	MP2GRWH	C2.17
ML4T-CY	D2.135	MLT6S-CP	B3.5	MP2TSWH	C2.17
ML8-CY	D2.134	MLT6S-CP316	B3.6	MP350-C	B2.29
ML8T-CY	D2.135	MLT6SH-LP	B3.6	MP350-C0	B2.29
MLT10EH-LP	B3.6	MLT6SH-LP316	B3.7	MP3G1062TSWH	C2.17
MLT10EH15-LP	B3.6	MLT8DEH-Q	B3.11	MP3G106WH	C2.17
MLT10H-LP	B3.6	MLT8DEH-Q316	B3.11	MP3GRWH	C2.17
MLT10H-LP316	B3.7	MLT8DEH15-Q	B3.11	MP3TSWH	C2.17
MLT10S-CP	B3.5	MLT8DEH15-Q316	B3.11	MPMH38-L0	B2.20
MLT10S-CP316	B3.6	MLT8DSH-Q	B3.11	MPMS19-C0	B2.20
MLT10SH-LP	B3.6	MLT8DSH-Q316	B3.11	MPMS25-C0	B2.20
MLT12EH-Q	B3.6	MLT8EH-LP	B3.6	MPMWH32-L0	B2.20
MLT12EH15-Q	B3.6	MLT8EH-LP316	B3.7	MPWM-H56-Q	B3.27
MLT12H-Q	B3.6	MLT8H-LP	B3.6	MRS1.5H-L4	B3.19
MLT12S-Q	B3.5	MLT8H-LP316	B3.7	MRS1.5H-L6	B3.19
MLT12SH-Q	B3.6	MLT8LH-LP	B3.6	MRS1.5LH-L4	B3.19
MLT14H-Q	B3.6	MLT8LH-LP316	B3.6	MRS1.5LH-L6	B3.19
MLT14S-Q	B3.5	MLT8SH-LP	B3.6	MRS1S-C4	B3.19
MLT15S-Q	B3.5	MLT8SH-LP316	B3.7	MRS1S-C6	B3.19
MLT1H-LPAL	B3.10	MLT8S-CP	B3.5	MRS2H-L4	B3.19
MLT1H-LPALBL	B3.10	MLT8S-CP316	B3.6	MRS2H-L6	B3.19
MLT1H-LPALBU	B3.10	MLT8SH-LP	B3.6	MRS2LH-L4	B3.19
MLT1H-LPALGR	B3.10	MLT8SH-LP316	B3.7	MRS2LH-L6	B3.19
MLT1H-LPALRD	B3.10	MLTC10H-LP316	B3.9	MRS2S-C4	B3.19
MLT1H-LPALYL	B3.10	MLTC2H-LP316	B3.9	MRS2S-C6	B3.19
MLT1S-CP	B3.5	MLTC4H-LP316	B3.9	MRS4H-L4	B3.19
MLT1S-CP316	B3.6	MLTC6H-LP316	B3.9	MRS4H-L6	B3.19
MLT2.7H-LP	B3.6	MLTC8H-LP316	B3.9	MRS4LH-L4	B3.19
MLT2.7H-LP316	B3.7	MLTFC2H-LP316	B3.8	MRS4LH-L6	B3.19
MLT2.7S-CP	B3.5	MLTFC2S-CP316	B3.8	MRS4S-C4	B3.19
MLT2.7S-CP316	B3.6	MLTFC4EH-LP316	B3.8	MRS4S-C6	B3.19
MLT2DH-L	B3.11	MLTFC4H-LP316	B3.8	MRS6H-L4	B3.19
MLT2H-LP	B3.6	MLTFC4S-CP316	B3.8	MRS6H-L6	B3.19
MLT2H-LP316	B3.7	MLTFC4SH-LP316	B3.8	MRS6LH-L4	B3.19
MLT2H-LPAL	B3.10	MLTFC6EH-LP316	B3.8	MRS6LH-L6	B3.19
MLT2H-LPALBL	B3.10	MLTFC6H-LP316	B3.8	MRS6S-C4	B3.19
MLT2H-LPALBU	B3.10	MLTFC6S-CP316	B3.8	MRS6S-C6	B3.19
MLT2H-LPALGR	B3.10	MLTFC6SH-LP316	B3.8	MRT1.5H-L4	B3.18
MLT2H-LPALRD	B3.10	MLTFC8EH-LP316	B3.8	MRT1.5H-L6	B3.18
MLT2H-LPALYL	B3.10	MLTFC8H-LP316	B3.8	MRT1.5LH-L4	B3.18
MLT2LH-LP	B3.6	MLTFC8S-CP316	B3.8	MRT1.5LH-L6	B3.18
MLT2LH-LP316	B3.6	MLTFC8SH-LP316	B3.8	MRT1S-C4	B3.18
MLT2S-CP	B3.5	MMP172-C	E4.3	MRT1S-C6	B3.18
MLT2S-CP316	B3.6	MMP172-C316	E4.3	MRT2H-L4	B3.18
MLT2S-L	B3.5	MMP172W38-C	E4.3	MRT2H-L6	B3.18
MLT4DEH-Q	B3.11	MMP172W38-C316	E4.3	MRT2LH-L4	B3.18
MLT4DEH-Q316	B3.11	MMP338W21-Q	E4.3	MRT2LH-L6	B3.18
MLT4DEH15-Q	B3.11	MMP350-C	E4.3	MRT2S-C4	B3.18
MLT4DEH15-Q316	B3.11	MMP350-C316	E4.3	MRT2S-C6	B3.18

A. System Overview
B1. Cable Ties
B2. Cable Accessories
B3. Stainless Steel Ties
C1. Wiring Duct
C2. Surface Raceway
C3. Abrasion Protection
C4. Cable Management
D1. Terminals
D2. Power Connectors
D3. Grounding Connectors
E1. Labeling Systems
E2. Labels
E3. Pre-Printed & Write-On Markers
E4. Permanent Identification
E5. Lockout/Tagout & Safety Solutions
F. Index

PANDUIT® ELECTRICAL SOLUTIONS

A. System Overview	Part Number	Page Number	Part Number	Page Number	Part Number	Page Number
B1. Cable Ties	MRT4H-L4	B3.18	MTHEH-C	B3.13	NE.5X1WH6	C1.24
	MRT4H-L6	B3.18	MTHEH-C316	B3.13	NE1.5X1.5WH6	C1.24
	MRT4LH-L4	B3.18	MTHH-C	B3.13	NE1.5X2WH6	C1.24
	MRT4LH-L6	B3.18	MTHH-C316	B3.13	NE1.5X3WH6	C1.24
	MRT4S-C4	B3.18	MTHS-C	B3.13	NE1.5X4WH6	C1.24
	MRT4S-C6	B3.18	MTHS-C316	B3.13	NE1X1.5WH6	C1.24
B2. Cable Accessories	MRT6H-L4	B3.18	MTHSH-C	B3.13	NE1X1WH6	C1.24
	MRT6H-L6	B3.18	MTHSH-C316	B3.13	NE1X2WH6	C1.24
	MRT6LH-L4	B3.18	MTM1H-C	B3.27	NE1X3WH6	C1.24
	MRT6LH-L6	B3.18	MTM1H10-C	B3.27	NE1X4WH6	C1.24
	MRT6S-C4	B3.18	MTM1H25-C	B3.27	NE2X1WH6	C1.24
	MRT6S-C6	B3.18	MTM2H-Q	B3.28	NE2X2WH6	C1.24
B3. Stainless Steel Ties	MS10W38T15-L4	B3.23	MTMBH-Q	B3.29	NE2X3WH6	C1.24
	MS10W38T15-L6	B3.23	MTP1H-E10-C	B2.15	NE2X4WH6	C1.24
	MS10W50T15-L4	B3.23	MTP1H-E6-C	B2.15	NE3X1WH6	C1.24
	MS10W50T15-L6	B3.23	MTP1S-E10-C	B2.15	NE3X2WH6	C1.24
	MS10W63T15-L4	B3.23	MTP1S-E6-C	B2.15	NE3X3WH6	C1.24
	MS10W63T15-L6	B3.23	MTP2H-E10-C	B2.15	NE3X4WH6	C1.24
C1. Wiring Duct	MS2W38T15-L4	B3.23	MTP2H-E6-C	B2.15	NE3X5WH6	C1.24
	MS2W38T15-L6	B3.23	MTP2S-E10-C	B2.15	NE4X2WH6	C1.24
	MS4W38T15-L4	B3.23	MTP2S-E6-C	B2.15	NE4X3WH6	C1.24
	MS4W38T15-L6	B3.23	MTP3H-E10-C	B2.16	NE4X4WH6	C1.24
	MS4W50T15-L4	B3.23	MTP3H-E6-C	B2.16	NE4X5WH6	C1.24
	MS4W50T15-L6	B3.23	MTP3S-E10-C	B2.16	NK2HSRFIW	C2.54
C2. Surface Raceway	MS4W63T15-L4	B3.23	MTP3S-E6-C	B2.16	NK4HSRFIW	C2.54
	MS4W63T15-L6	B3.23	MTP4H-E10-C	B2.16	NK4VSRFIW	C2.54
	MS6W38T15-L4	B3.23	MTP4H-E6-C	B2.16	NNC100X100LG2	C1.21
	MS6W38T15-L6	B3.23	MTP4S-E10-C	B2.16	NNC100X50LG2	C1.21
	MS6W50T15-L4	B3.23	MTP4S-E6-C	B2.16	NNC100X75LG2	C1.21
	MS6W50T15-L6	B3.23	MTP5H-E10-C	B2.16	NNC25X25LG2	C1.21
C3. Abrasion Protection	MS6W63T15-L4	B3.23	MTP5H-E6-C	B2.16	NNC25X37LG2	C1.21
	MS6W63T15-L6	B3.23	MTP5S-E10-C	B2.16	NNC25X50LG2	C1.21
	MS8W38T15-L4	B3.23	MTP5S-E6-C	B2.16	NNC25X75LG2	C1.21
	MS8W38T15-L6	B3.23	MTP6H-E10-C	B2.16	NNC37X37LG2	C1.21
	MS8W50T15-L4	B3.23	MTP6H-E6-C	B2.16	NNC37X50LG2	C1.21
	MS8W50T15-L6	B3.23	MTPC1H-E10-C39	B2.16	NNC37X75LG2	C1.21
C4. Cable Management	MS8W63T15-L4	B3.23	MTPC2H-E10-C39	B2.16	NNC50DWH2	C1.21, C1.27
	MS8W63T15-L6	B3.23	MTPC3H-E10-C39	B2.16	NNC50X100LG2	C1.21
	MSBW38-C4	B3.25	MTPC4H-E10-C39	B2.16	NNC50X50LG2	C1.21
	MSBW38-C6	B3.25	MTPC5H-E10-C39	B2.16	NNC50X75LG2	C1.21
	MSBW50-C4	B3.25	MTPC6H-E10-C39	B2.16	NNC75DWH2	C1.21, C1.27
	MSBW50-C6	B3.25	MTRTH	B3.20	NNC75X75LG2	C1.21
D1. Terminals	MSBW63-C4	B3.25	MTRTLS	B3.20	NR1-C	C1.34
	MSBW63-C6	B3.25			NR1-M	C1.34
	MSC10W38T15-L6	B3.24			NR2WH-L	C1.59
	MSC10W50T15-L6	B3.24			NR4BL-L	C1.59
	MSC10W63T15-L6	B3.24				
	MSC2W38T15-L6	B3.24				
D2. Power Connectors	MSC4W38T15-L6	B3.24				
	MSC4W50T15-L6	B3.24				
	MSC4W63T15-L6	B3.24				
	MSC6W38T15-L6	B3.24				
	MSC6W50T15-L6	B3.24				
	MSC6W63T15-L6	B3.24				
D3. Grounding Connectors	MSC8W38T15-L6	B3.24				
	MSC8W50T15-L6	B3.24				
	MSC8W63T15-L6	B3.24				
	MSCN150T15-L6	B3.24				
	MSCN175T15-L6	B3.24				
	MSCN200T15-L6	B3.24				
E1. Labeling Systems	MSW38T15-CR4	B3.25				
	MSW38T15-CR6	B3.25				
	MSW50T15-CR4	B3.25				
	MSW50T15-CR6	B3.25				
	MSW63T15-CR4	B3.25				
	MSW63T15-CR6	B3.25				
E2. Labels	MT125S-Q	E4.4				
	MT150D-Q	E4.4				
	MT150D-Q316	E4.4				
	MT172-C	E4.4				
	MT172-C316	E4.4				
	MT172W38-C	E4.4, E5.14				
E3. Pre-Printed & Write-On Markers	MT1D-Q	E4.4				
	MT1D-Q316	E4.4				
	MT213D-Q	E4.4				
	MT213D-Q316	E4.4				
	MT338W21-Q	E4.4				
	MT350-C	E4.4				
E4. Permanent Identification	MT350-C316	E4.4				
	MT350W17-Q	E4.4				
	MTB150D-Q	E4.4				
	MTB1D-Q	E4.4, E5.14				
	MTB213D-Q	E4.4				
	MTHCEH-C316	B3.13				
E5. Lockout/Tagout & Safety Solutions	MTHCH-C316	B3.13				
	MTHCSH-C316	B3.13				
F. Index						

PANDUIT® ELECTRICAL SOLUTIONS

Part Number	Page Number	Part Number	Page Number	Part Number	Page Number
OFR20WEOB	C2.100	P18-6RHT6-C	D1.18	PCA07-MIN	E3.11
OFVR5OBB6	C2.98	P18-6RN-C	D1.17	PCA07-PLS	E3.11
		P18-6SLF-C	D1.31	PCA07-U-Z	E3.11
		P18-8F-C	D1.29	PCA07-Z	E3.11
		P18-8FF-C	D1.30	PCA11-0	E3.12
		P18-8LF-C	D1.30	PCA11-0-9	E3.12
		P18-8R-C	D1.17	PCA11-9	E3.12
		P18-8RHT6-C	D1.18	PCA11-A	E3.12
		P18-8SLF-C	D1.31	PCA11-A-J	E3.12
		P18-P47-C	D1.54	PCA11-K-T	E3.12
		P2-10R-X	D1.19	PCA11-MIN	E3.12
		P2-12R-X	D1.19	PCA11-PLS	E3.12
		P2-14R-X	D1.19	PCA11-U-Z	E3.12
		P2-38R-X	D1.19	PCA11-Z	E3.12
		P2-56R-X	D1.19	PCA13-0	E3.12
		P22-10R-C	D1.17	PCA13-0-9	E3.12
		P22-2F-C	D1.29	PCA13-9	E3.12
		P22-2R-C	D1.17	PCA13-A	E3.12
		P22-4F-C	D1.29	PCA13-A-J	E3.12
		P22-4R-C	D1.17	PCA13-K-T	E3.12
		P22-6F-C	D1.29	PCA13-MIN	E3.12
		P22-6R-C	D1.17	PCA13-PLS	E3.12
		P22-8R-C	D1.17	PCA13-U-Z	E3.12
		P2NLT-500-3	D2.140	PCA13-Z	E3.12
		P32W2A2-100-7	C2.84	PCA18-0	E3.12
		P32W2A2-100-72	C2.84	PCA18-0-9	E3.12
		P32W2A2-50-7	C1.32, C2.84	PCA18-9	E3.12
		P32W2A2-50-72	C1.32, C2.84	PCA18-A	E3.12
		P32W2A2-75-7	C1.32, C2.84	PCA18-A-J	E3.12
		P32W2A2-75-72	C1.32, C2.84	PCA18-K-T	E3.12
		P32W2R1-100-7	C2.84	PCA18-MIN	E3.12
		P32W2R1-100-72	C2.84	PCA18-PLS	E3.12
		P32W2R1-150-72	C2.84	PCA18-U-Z	E3.12
		P32W2R1-50-7	C2.84	PCA18-Z	E3.12
		P32W2R1-50-72	C2.84	PCA23-0	E3.12
		P32W2R1-75-7	C2.84	PCA23-0-3	E3.12
		P32W2R1-75-72	C2.84	PCA23-4-7	E3.12
		P4-10R-E	D1.19	PCA23-8-9	E3.12
		P4-12R-E	D1.19	PCA23-9	E3.12
		P4-14R-E	D1.19	PCA23-A	E3.12
		P4-38R-E	D1.19	PCA23-A-D	E3.12
		P4-56R-E	D1.19	PCA23-E-H	E3.12
		P6-10R-E	D1.19	PCA23-I-L	E3.12
		P6-12R-E	D1.19	PCA23-M-P	E3.12
		P6-14R-E	D1.19	PCA23-MIN	E3.12
		P6-38R-E	D1.19	PCA23-PLS	E3.12
		P6-56R-E	D1.19	PCA23-Q-T	E3.12
		P6-8R-E	D1.19	PCA23-U-X	E3.12
		P8-10R-Q	D1.19	PCA23-Y-Z	E3.12
		P8-12R-Q	D1.19	PCA23-Z	E3.12
		P8-14R-Q	D1.19	PCL037-0	E5.35
		P8-38R-Q	D1.19	PCL037-0-9	E5.35
		P8-56R-Q	D1.19	PCL037-1	E5.35
		P8-8R-Q	D1.19	PCL037-9	E5.35
		PARW125-RED	E5.29	PCL037-A	E5.35
		PARW125-YEL	E5.29	PCL037-A-Z	E5.35
		PAT1.5M	B1.115	PCL037-Z	E5.35
		PAT1M	B1.115	PCL062-0	E5.35
		PAT2S	B1.115	PCL062-0-9	E5.35
		PAT2SBM	B1.117	PCL062-1	E5.35
		PATMBM	B1.117	PCL062-9	E5.35
		PBDCB	C1.34	PCL062-A	E5.35
		PBMS-H25-C	B2.19	PCL062-A-Z	E5.35
		PBMS-H25-C14	B2.19	PCL062-DSH	E5.35
		PBMS-H25-M0	B2.19	PCL062-Z	E5.35
		PBMS-H25-M30	B2.19	PCL100-0	E5.35
		PBMSL-H25-C30	B2.19	PCL100-0-9	E5.35
		PBMSL-H25-M30	B2.19	PCL100-1	E5.35
		PBSC1-X	B2.50	PCL100-9	E5.35
		PBSC12-X	B2.50	PCL100-A	E5.35
		PBSC3-X	B2.50	PCL100-A-J	E5.35
		PBSC6-X	B2.50	PCL100-DSH	E5.35
		PC038-H25D-C0	B2.39	PCL100-K-T	E5.35
		PC050-H25D-C0	B2.39	PCL100-U-Z	E5.35
		PC062-H25D-C0	B2.39	PCL100-Z	E5.35
		PC075-H25D-C0	B2.39	PCL200-0	E5.35
		PC087-H25D-C0	B2.39	PCL200-0-9	E5.35
		PC100-H25D-C0	B2.39	PCL200-1	E5.35
		PC112-H25D-C0	B2.39	PCL200-9	E5.35
		PC125-H25D-C0	B2.39	PCL200-A	E5.35
		PCA07-0	E3.11	PCL200-A-J	E5.35
		PCA07-0-9	E3.11	PCL200-DSH	E5.35
		PCA07-9	E3.11	PCL200-K-T	E5.35
		PCA07-A	E3.11	PCL200-U-Z	E5.35
		PCA07-A-J	E3.11	PCL200-Z	E5.35
		PCA07-K-T	E3.11	PCL300-0	E5.36

A. System Overview
B1. Cable Ties
B2. Cable Accessories
B3. Stainless Steel Ties
C1. Wiring Duct
C2. Surface Raceway
C3. Abrasion Protection
C4. Cable Management
D1. Terminals
D2. Power Connectors
D3. Grounding Connectors
E1. Labeling Systems
E2. Labels
E3. Pre-Printed & Write-On Markers
E4. Permanent Identification
E5. Lockout/Tagout & Safety Solutions
F. Index

PANDUIT® ELECTRICAL SOLUTIONS

A. System Overview	Part Number	Page Number	Part Number	Page Number	Part Number	Page Number
B1. Cable Ties	PCL300-1	E5.36	PCMB-13	E3.2	PCSB350-6-2	D2.157
	PCL300-9	E5.36	PCMB-14	E3.2	PCSB350-6S-2Y	D2.155
	PCL300-A	E5.36	PCMB-15	E3.2	PCSB350-7-2	D2.157
	PCL300-DSH	E5.36	PCMB-16	E3.2	PCSB350-8-2	D2.157
	PCL300-Z	E5.36	PCMB-2	E3.2	PCSB350-8S-2Y	D2.155
B2. Cable Accessories	PCLCP037-0-9	E5.35	PCMB-25	E3.2	PCSB4-10-4Y	D2.156
	PCLCP037-A-Z	E5.35	PCMB-3	E3.2	PCSB4-10S-4Y	D2.155
	PCLCP062-0-9	E5.35	PCMB-4	E3.2	PCSB4-12-3Y	D2.156
	PCLCP062-A-Z	E5.35	PCMB-5	E3.2	PCSB4-12S-3Y	D2.155
	PCLCP100-0-9	E5.35	PCMB-6	E3.2	PCSB4-14-2Y	D2.156
B3. Stainless Steel Ties	PCLCP100-A-Z	E5.35	PCMB-7	E3.2	PCSB4-14S-2Y	D2.155
	PCLCP200-0-9	E5.35	PCMB-8	E3.2	PCSB4-2-12Y	D2.156
	PCLCP200-A-Z	E5.35	PCMB-9	E3.2	PCSB4-2S-12Y	D2.155
	PCLCP300-0-9	E5.36	PCMCP-1-25	E3.6	PCSB4-3-12Y	D2.156
	PCLCP300-A-Z	E5.36	PCMCP-101-125	E3.6	PCSB4-3S-12Y	D2.155
C1. Wiring Duct	PCM-0	E3.4	PCMCP-126-150	E3.6	PCSB4-4-6Y	D2.156
	PCM-0-9	E3.4	PCMCP-26-50	E3.6	PCSB4-4S-6Y	D2.155
	PCM-1-10	E3.4	PCMCP-51-75	E3.6	PCSB4-5-6Y	D2.156
	PCM-1-12	E3.4	PCMCP-76-100	E3.6	PCSB4-5S-6Y	D2.155
	PCM-1-16	E3.4	PCMCP-A-Z	E3.6	PCSB4-6-6Y	D2.156
C2. Surface Raceway	PCM-1-18	E3.4	PCMH-0	E3.4	PCSB4-6S-6Y	D2.155
	PCM-1-3	E3.4	PCMH-25	E3.4	PCSB4-7-4Y	D2.156
	PCM-1-33	E3.4	PCPA11IW	C2.107	PCSB4-8-4Y	D2.156
	PCM-1-4	E3.4	PCPA11R20IW	C2.104	PCSB500-2-4Y	D2.157
	PCM-1-5	E3.4	PCPA13IW	C2.107	PCSB500-3-3Y	D2.157
C3. Abrasion Protection	PCM-1-6	E3.4	PCPA13R20IW	C2.104	PCSB500-4-2Y	D2.157
	PCM-1-8	E3.4	PCPAK16IW	C2.110	PCSB500-5-2Y	D2.157
	PCM-1-9	E3.4	PCPAK22IW	C2.110	PCSB500-6-2Y	D2.157
	PCM-100	E3.4	PCPAKR20IW	C2.110	PCSB500-7-2Y	D2.157
	PCM-100-124	E3.4	PCPAKR1W	C2.110	PCSB500-8-2Y	D2.157
C4. Cable Management	PCM-125-149	E3.4	PCPBRC	C2.111	PCSB600-10-1Y	D2.157
	PCM-150-174	E3.4	PCPECIW	C2.111	PCSB600-10S-1Y	D2.155
	PCM-175-199	E3.4	PCPKITIW	C2.111	PCSB600-12-1Y	D2.157
	PCM-19-36	E3.4	PCPTPIW	C2.111	PCSB600-12S-1Y	D2.155
	PCM-202	E3.4	PCSB2/0-10-2Y	D2.156	PCSB600-14-1Y	D2.157
D1. Terminals	PCM-34-66	E3.4	PCSB2/0-10S-2Y	D2.155	PCSB600-14S-1Y	D2.155
	PCM-67-99	E3.4	PCSB2/0-12-2Y	D2.156	PCSB600-2-4Y	D2.157
	PCM-99	E3.4	PCSB2/0-12S-1Y	D2.155	PCSB600-2S-4Y	D2.155
	PCM-A	E3.5	PCSB2/0-14-1Y	D2.156	PCSB600-3-3Y	D2.157
	PCM-A-Z	E3.5	PCSB2/0-14S-1Y	D2.155	PCSB600-3S-3Y	D2.155
D2. Power Connectors	PCM-A-Z-0-9	E3.5	PCSB2/0-2-12	D2.156	PCSB600-4-2Y	D2.157
	PCM-A1	E3.5	PCSB2/0-2S-6	D2.155	PCSB600-4S-2Y	D2.155
	PCM-A4	E3.5	PCSB2/0-3-6	D2.156	PCSB600-5-2	D2.157
	PCM-B1	E3.5	PCSB2/0-3S-6Y	D2.155	PCSB600-5S-2Y	D2.155
	PCM-B5	E3.5	PCSB2/0-4-6	D2.156	PCSB600-6-2Y	D2.157
D3. Grounding Connectors	PCM-BLK	E3.6	PCSB2/0-4S-6Y	D2.155	PCSB600-6S-2Y	D2.155
	PCM-BRN	E3.6	PCSB2/0-5-6	D2.156	PCSB600-8-2Y	D2.157
	PCM-C1	E3.5	PCSB2/0-5S-4Y	D2.155	PCSB600-8S-2Y	D2.155
	PCM-C4	E3.5	PCSB2/0-6-6	D2.156	PCSB750-10-1Y	D2.157
	PCM-DBL	E3.6	PCSB2/0-6S-4Y	D2.155	PCSB750-2-2Y	D2.157
E1. Labeling Systems	PCM-DGN	E3.6	PCSB2/0-7-4	D2.156	PCSB750-3-2Y	D2.157
	PCM-E1	E3.5	PCSB2/0-8-4	D2.156	PCSB750-4-2Y	D2.157
	PCM-E3	E3.5	PCSB2/0-8S-3	D2.155	PCSB750-5-1Y	D2.157
	PCM-F1	E3.5	PCSB250-10-2Y	D2.156	PCSB750-6-1Y	D2.157
	PCM-F4	E3.5	PCSB250-10S-2Y	D2.155	PCSB750-7-1Y	D2.157
E2. Labels	PCM-GRY	E3.6	PCSB250-12-2Y	D2.156	PCSB750-8-1Y	D2.157
	PCM-H1	E3.5	PCSB250-12S-2Y	D2.155	PCSB750-9-1Y	D2.157
	PCM-H5	E3.5	PCSB250-14-1Y	D2.156	PCSBMT2/0-10-2Y	D2.160
	PCM-L1	E3.5	PCSB250-14S-1Y	D2.155	PCSBMT2/0-10S2Y	D2.159
	PCM-L5	E3.5	PCSB250-2-6Y	D2.156	PCSBMT2/0-12-1Y	D2.160
E3. Pre-Printed & Write-On Markers	PCM-LBL	E3.6	PCSB250-2S-6Y	D2.155	PCSBMT2/0-12S1Y	D2.159
	PCM-LGN	E3.6	PCSB250-3-6Y	D2.156	PCSBMT2/0-4-3Y	D2.160
	PCM-M1	E3.5	PCSB250-3S-6Y	D2.155	PCSBMT2/0-8-2Y	D2.160
	PCM-M2	E3.5	PCSB250-4-6Y	D2.156	PCSBMT2/0-8S-2Y	D2.159
	PCM-ORN	E3.6	PCSB250-4S-6Y	D2.155	PCSBMT2/0-6-2Y	D2.160
E4. Permanent Identification	PCM-P1	E3.5	PCSB250-5-4Y	D2.156	PCSBMT2/0-6S-2Y	D2.159
	PCM-P3	E3.5	PCSB250-5S-4Y	D2.155	PCSBMT2/0-8-2Y	D2.160
	PCM-PNK	E3.6	PCSB250-6-4Y	D2.156	PCSBMT2/0-8S-2Y	D2.159
	PCM-PUR	E3.6	PCSB250-6S-4Y	D2.155	PCSBMT250-10-2Y	D2.160
	PCM-R1	E3.5	PCSB250-7-3Y	D2.156	PCSBMT250-10S2Y	D2.159
E5. Lockout/Tagout & Safety Solutions	PCM-R5	E3.5	PCSB250-7-3Y	D2.156	PCSBMT250-12-1Y	D2.160
	PCM-RED	E3.6	PCSB250-8-3Y	D2.156	PCSBMT250-12S1Y	D2.159
	PCM-S1	E3.5	PCSB250-8S-3Y	D2.155	PCSBMT250-4-2Y	D2.160
	PCM-S5	E3.5	PCSB350-10-2Y	D2.157	PCSBMT250-4S-2Y	D2.159
	PCM-T1	E3.5	PCSB350-10S-2Y	D2.155	PCSBMT250-6-2Y	D2.160
F. Index	PCM-T9	E3.5	PCSB350-12-1Y	D2.157	PCSBMT250-6S-2Y	D2.159
	PCM-TAN	E3.6	PCSB350-12S-1Y	D2.155	PCSBMT250-8-2Y	D2.160
	PCM-WHT	E3.6	PCSB350-14-1Y	D2.157	PCSBMT250-8S-2Y	D2.159
	PCM-X1	E3.5	PCSB350-14S-1Y	D2.155	PCSBMT350-10-1Y	D2.160
	PCM-X4	E3.5	PCSB350-2-4	D2.157	PCSBMT350-10S1Y	D2.159
	PCM-YEL	E3.6	PCSB350-2S-4Y	D2.155	PCSBMT350-12-1Y	D2.160
	PCM-Z	E3.5	PCSB350-3-4	D2.157	PCSBMT350-12S1Y	D2.159
	PCMB-1	E3.2	PCSB350-3S-4Y	D2.155	PCSBMT350-4-2Y	D2.160
	PCMB-10	E3.2	PCSB350-4-3	D2.157	PCSBMT350-4S-2Y	D2.159
	PCMB-11	E3.2	PCSB350-4S-3Y	D2.155	PCSBMT350-6-2Y	D2.160
	PCMB-12	E3.2	PCSB350-5-3	D2.157	PCSBMT350-6S-2Y	D2.159
			PCSB350-5S-3Y	D2.155	PCSBMT350-8-2Y	D2.160

PANDUIT® ELECTRICAL SOLUTIONS

Part Number	Page Number	Part Number	Page Number	Part Number	Page Number
PCSBMT350-8S-2Y	D2.159	PCV-415A	E5.30	PESC-H-E	E5.23
PCSBMT600-10-1Y	D2.160	PCV-415AY	E5.30	PESC-H-EC	E5.23
PCSBMT600-10S1Y	D2.159	PCV-415B	E5.30	PESC-H-HT	E5.23
PCSBMT600-12-1Y	D2.160	PCV-415BY	E5.30	PESC-H-PE	E5.23
PCSBMT600-12S1Y	D2.159	PCV-415CY	E5.30	PESC-J-AT	E5.23
PCSBMT600-4-2Y	D2.160	PCV-4160A	E5.30	PESC-J-E	E5.23
PCSBMT600-4S-2Y	D2.159	PCV-4160AY	E5.30	PESC-J-EC	E5.23
PCSBMT600-6-2Y	D2.160	PCV-4160BY	E5.30	PESC-J-HT	E5.23
PCSBMT600-6S-2Y	D2.159	PCV-4160CY	E5.30	PESC-J-PE	E5.23
PCSBMT600-8-2Y	D2.160	PCV-440A	E5.30	PESS-A-CE	E5.24
PCSBMT600-8S-2Y	D2.159	PCV-440AY	E5.30	PESS-A-ES	E5.24
PCSH-B-CR	B3.26	PCV-440BY	E5.30	PESS-A-L1	E5.24
PCSS-B-CR	B3.26	PCV-440CY	E5.30	PESS-A-L2	E5.24
PCSSH-B-CR	B3.26	PCV-460A	E5.30	PESS-A-L3	E5.24
PCV-110A	E5.30	PCV-460AY	E5.30	PESS-A-LF	E5.24
PCV-110AY	E5.30	PCV-460BY	E5.30	PESS-A-N	E5.24
PCV-110BY	E5.30	PCV-460CY	E5.30	PESS-A-PE	E5.24
PCV-110CY	E5.30	PCV-480A	E5.30	PESS-A-ROHS	E5.24
PCV-115A	E5.30	PCV-480AY	E5.30	PESS-A-SS	E5.24
PCV-115AY	E5.30	PCV-480BY	E5.30	PESS-B-CE	E5.24
PCV-115BY	E5.30	PCV-480CY	E5.30	PESS-B-ES	E5.24
PCV-115CY	E5.30	PCV-600A	E5.30	PESS-B-L1	E5.24
PCV-120/208A	E5.30	PCV-600AY	E5.30	PESS-B-L2	E5.24
PCV-120/208AY	E5.30	PCV-600BY	E5.30	PESS-B-L3	E5.24
PCV-120/208BY	E5.30	PCV-600CY	E5.30	PESS-B-N	E5.24
PCV-120/208CY	E5.30	PCV-BLANKA	E5.30	PESS-B-SS	E5.24
PCV-120A	E5.30	PCV-BLANKAY	E5.30	PESS-C-CE	E5.24
PCV-120AY	E5.30	PCV-BLANKBY	E5.30	PESS-C-ES	E5.24
PCV-120BY	E5.30	PCV-BLANKCY	E5.30	PESS-C-L1	E5.24
PCV-120CY	E5.30	PCV-ESA	E5.30	PESS-C-L2	E5.24
PCV-12470A	E5.30	PCV-ESAY	E5.30	PESS-C-L3	E5.24
PCV-12470AY	E5.30	PCV-ESBY	E5.30	PESS-C-N	E5.24
PCV-12470BY	E5.30	PCV-ESCY	E5.30	PESS-C-SS	E5.24
PCV-12470CY	E5.30	PCV-FAA	E5.30	PESS-D-CE	E5.24
PCV-13200A	E5.30	PCV-FAAY	E5.30	PESS-D-ES	E5.24
PCV-13200AY	E5.30	PCV-FABY	E5.30	PESS-D-L1	E5.24
PCV-13200BY	E5.30	PCV-FAC	E5.30	PESS-D-L2	E5.24
PCV-13200CY	E5.30	PCV-FACY	E5.30	PESS-D-L3	E5.24
PCV-13800A	E5.30	PCV-FOA	E5.30	PESS-D-N	E5.24
PCV-13800AY	E5.30	PCV-FOAY	E5.30	PESS-D-SS	E5.24
PCV-13800BY	E5.30	PCV-FOBY	E5.30	PESS-E-CE	E5.24
PCV-13800CY	E5.30	PCV-FOCA	E5.30	PESS-E-ES	E5.24
PCV-1PHA	E5.30	PCV-FOCAY	E5.30	PESS-E-L1	E5.24
PCV-1PHAY	E5.30	PCV-FOCBY	E5.30	PESS-E-L2	E5.24
PCV-1PHBY	E5.30	PCV-FOCCY	E5.30	PESS-E-L3	E5.24
PCV-1PHCY	E5.30	PCV-FOCY	E5.30	PESW-A-1	E5.25
PCV-208A	E5.30	PCV-MAINA	E5.30	PESW-A-11	E5.25
PCV-208AY	E5.30	PCV-MAINAY	E5.30	PESW-A-11Y	E5.25
PCV-208BY	E5.30	PCV-MAINBY	E5.30	PESW-A-1Y	E5.25
PCV-208CY	E5.30	PCV-MAINCY	E5.30	PESW-A-6	E5.25
PCV-220A	E5.30	PCV-TELEA	E5.30	PESW-A-6Y	E5.25
PCV-220AY	E5.30	PCV-TELEAY	E5.30	PESW-A-8	E5.25
PCV-220BY	E5.30	PCV-TELEBY	E5.30	PESW-A-8Y	E5.25
PCV-220CY	E5.30	PCV-TELECY	E5.30	PESW-A-9	E5.25
PCV-2300A	E5.30	PCVB-110	E5.31	PESW-A-9Y	E5.25
PCV-2300AY	E5.30	PCVB-220	E5.31	PESW-B-1	E5.25
PCV-2300BY	E5.30	PCVB-277	E5.31	PESW-B-11Y	E5.25
PCV-2300CY	E5.30	PCVB-277/480	E5.31	PESW-B-1Y	E5.25
PCV-230A	E5.30	PCVB-4160	E5.31	PESW-B-6Y	E5.25
PCV-230AY	E5.30	PCVB-440	E5.31	PESW-B-8Y	E5.25
PCV-230BY	E5.30	PCVB-480	E5.31	PESW-B-9Y	E5.25
PCV-230CY	E5.30	PCWL-ACC	E5.27	PESW-C-11Y	E5.25
PCV-2400A	E5.30	PCWL-BL	E5.27	PESW-C-1Y	E5.25
PCV-2400AY	E5.30	PCWL-CAL	E5.27	PESW-C-6Y	E5.25
PCV-2400BY	E5.30	PCWL-CALD	E5.27	PESW-C-8Y	E5.25
PCV-2400CY	E5.30	PCWL-ICAL	E5.27	PESW-C-9Y	E5.25
PCV-240A	E5.30	PCWL-REJ	E5.27	PESW-D-11Y	E5.25
PCV-240AY	E5.30	PD-DIA	B1.117	PESW-D-1Y	E5.25
PCV-240BY	E5.30	PD-600-A	D1.86	PESW-D-6Y	E5.25
PCV-240CY	E5.30	PDH10-37	B1.117	PESW-D-8Y	E5.25
PCV-277/480A	E5.30	PDM	B1.115	PESW-D-9Y	E5.25
PCV-277/480AY	E5.30	PDM-DI	B1.117	PESW-E-11Y	E5.25
PCV-277/480BY	E5.30	PDS	B1.115	PESW-E-1Y	E5.25
PCV-277/480CY	E5.30	PDS-DI	B1.117	PESW-E-6Y	E5.25
PCV-277A	E5.30	PDSF	B1.116	PESW-E-8Y	E5.25
PCV-277AY	E5.30	PEIP-A-08Y	E5.29	PESW-E-9Y	E5.25
PCV-277BY	E5.30	PEIP-A-09Y	E5.29	PFX-0	B1.51, B2.28, E5.20
PCV-277CY	E5.30	PEIP-A-10Y	E5.29	PFX-2	B1.51, B2.28, E5.20
PCV-380A	E5.30	PEIP-A-11Y	E5.29	PG-1	D3.51
PCV-380AY	E5.30	PEIP-C-08-DY	E5.29	PG-1SC	D3.51
PCV-380BY	E5.30	PEIP-D-08Y	E5.29	PH10-10F-E	D1.31
PCV-380CY	E5.30	PEIP-D-09Y	E5.29	PH10-10R-E	D1.13
PCV-3PHA	E5.30	PEIP-D-10Y	E5.29	PH10-12R-E	D1.13
PCV-3PHAY	E5.30	PEIP-D-11Y	E5.29	PH10-14R-E	D1.13
PCV-3PHBY	E5.30	PES-S1	E5.10	PH10-38R-E	D1.13
PCV-3PHCY	E5.30	PESC-H-AT	E5.23	PH10-8F-E	D1.31

A. System Overview
B1. Cable Ties
B2. Cable Accessories
B3. Stainless Steel Ties
C1. Wiring Duct
C2. Surface Raceway
C3. Abrasion Protection
C4. Cable Management
D1. Terminals
D2. Power Connectors
D3. Grounding Connectors
E1. Labeling Systems
E2. Labels
E3. Pre-Printed & Write-On Markers
E4. Permanent Identification
E5. Lockout/Tagout & Safety Solutions
F. Index

PANDUIT® ELECTRICAL SOLUTIONS

A. System Overview	Part Number	Page Number	Part Number	Page Number	Part Number	Page Number	
B1. Cable Ties	PH10-8R-E	D1.13	PLD-12	E5.26	PLT1.5S-M30	B1.12	
	PH14-10F-Q	D1.31	PLD-17	E5.28	PLT10EH-C	B1.9	
	PH14-10R-Q	D1.13	PLD-18	E5.28	PLT10EH-Q0	B1.11	
	PH14-14R-Q	D1.13	PLD-22	E5.28	PLT10LH-L	B1.8	
	PH14-38R-Q	D1.13	PLD-28	E5.28	PLT12EH-C	B1.9	
	PH14-56R-Q	D1.13	PLD-29	E5.28	PLT12EH-Q0	B1.11	
	PH14-6F-Q	D1.31	PLD-3	E5.28	PLT13H-Q	B1.8	
	PH14-6R-Q	D1.13	PLD-30	E5.26	PLT13H-Q0	B1.10	
	PH14-8F-Q	D1.31	PLD-36	E5.26	PLT1M-C	B1.8	
	PH14-8R-Q	D1.13	PLD-37	E5.26	PLT1M-C0	B1.10	
B2. Cable Accessories	PH18-10F-Q	D1.31	PLD-38	E5.26	PLT1M-C30	B1.12	
	PH18-10R-Q	D1.13	PLD-4	E5.28	PLT1M-C702Y	B1.18	
	PH18-14R-Q	D1.13	PLD-43	E5.26	PLT1M-C76	B1.19	
	PH18-6F-Q	D1.31	PLD-45	E5.26	PLT1M-C86	B1.21	
	PH18-6R-Q	D1.13	PLD-46	E5.26	PLT1M-L0	B1.82	
	PH18-8F-Q	D1.31	PLD-47	E5.26	PLT1M-L1	B1.82	
	PH18-8R-Q	D1.13	PLD-52	E5.26	PLT1M-L1-0	B1.82	
	PHCAQ	B1.111	PLD-56	E5.26	PLT1M-L1-10	B1.82	
	PHCAT	B1.111	PLD-57	E5.26	PLT1M-L1-2	B1.82	
	PHM1	B1.116	PLD-58	E5.26	PLT1M-L1-4	B1.82	
B3. Stainless Steel Ties	PHM2	B1.116	PLD-60	E5.26	PLT1M-L1-7	B1.82	
	PHM3	B1.116	PLD-67	E5.26	PLT1M-L2	B1.82	
	PHM4	B1.116	PLD-68	E5.26	PLT1M-L3	B1.82	
	PHS2	B1.116	PLD-7	E5.28	PLT1M-L3-0	B1.82	
	PHS3	B1.116	PLD-71	E5.26	PLT1M-L3-10	B1.82	
	PISR1/0-1	D2.158	PLD-72	E5.26	PLT1M-L3-2	B1.82	
	PISR2-1	D2.158	PLD-74	E5.26	PLT1M-L3-4	B1.82	
	PISR250-1	D2.158	PLD-80	E5.26	PLT1M-L3-7	B1.82	
	PISR350-1	D2.158	PLD-81	E5.26	PLT1M-L4Y	B1.82	
	PISR500-1	D2.158	PLD-91	E5.26	PLT1M-L5	B1.82	
C1. Wiring Duct	PK10-10R-L	D1.12	PLF1M-C	B1.34	PLT1M-L5-0	B1.82	
	PK10-14R-L	D1.12	PLF1M-C0	B1.34	PLT1M-L5-10	B1.82	
	PK10-6R-L	D1.12	PLF1M-M69	B1.34	PLT1M-L5-2	B1.82	
	PK10-8R-L	D1.12	PLF1MA-C	B1.34	PLT1M-L5-4	B1.82	
	PK14-10R-C	D1.12	PLF1MA-M0	B1.34	PLT1M-L5-7	B1.82	
	PK14-14R-C	D1.12	PLF1MB-C	B1.34	PLT1M-L6	B1.82	
	PK14-4R-C	D1.12	PLF1MC-M	B1.34	PLT1M-L6-0	B1.82	
	PK14-6R-C	D1.12	PLM1M-C	B1.34	PLT1M-L6-10	B1.82	
	PK14-8R-C	D1.12	PLM1M-C0	B1.34	PLT1M-L6-2	B1.82	
	PK18-10R-C	D1.12	PLM1M-M69	B1.34	PLT1M-L6-4	B1.82	
C2. Surface Raceway	PK18-4R-C	D1.12	PLM2M-C	B1.34	PLT1M-L6-7	B1.82	
	PK18-6R-C	D1.12	PLM2M-M0	B1.34	PLT1M-L8	B1.82	
	PK18-8R-C	D1.12	PLM2S-C	B1.34	PLT1M-L8-0	B1.82	
	PL283N1	B1.117	PLM2S-C0	B1.34	PLT1M-L8-10	B1.82	
	PL289N1	B1.111, B3.16	PLM4S-C	B1.34	PLT1M-L8-2	B1.82	
	PL2M2S-L	B1.34	PLM4S-D0	B1.34	PLT1M-L8-4	B1.82	
	PL2M2S-L0	B1.34	PLMA14Y	E3.3	PLT1M-L8-7	B1.82	
	PL3B5EH-C0	B1.78	PLMA1Y	E3.3	PLT1M-M100	B1.17	
	PL3M2S-D0	B1.34	PLMA2Y	E3.3	PLT1M-M109	B1.16	
	PL3M2S-L	B1.34	PLMA3Y	E3.3	PLT1M-M300	B1.13	
C3. Abrasion Protection	PLA2S-A-Q	B2.6	PLP1.5I-C	B1.33	PLT1M-M60	B1.14	
	PLB2S-C	B1.76	PLP1.5I-M0	B1.33	PLT1M-M69	B1.14	
	PLB2S-C0	B1.76	PLP1.5I-M30	B1.33	PLT1M-XMR	B1.119	
	PLB2S-M30	B1.76	PLP1.5S-M	B1.33	PLT1M-XMR0	B1.119	
	PLB3S-C	B1.76	PLP1S-M	B1.33	PLT1M-XMR00	B1.119	
	PLB3S-C0	B1.76	PLP1S-M0	B1.33	PLT1M-XMR1	B1.119	
	PLB3S-M30	B1.76	PLP1S-M30	B1.33	PLT1M-XMR10	B1.119	
	PLB4H-TL	B1.76	PLP2S-C	B1.33	PLT1M-XMR2	B1.119	
	PLB4H-TL0	B1.76	PLP2S-M0	B1.33	PLT1M-XMR3	B1.119	
	PLB4H-TL30	B1.76	PLP2S-M30	B1.33	PLT1M-XMR30	B1.119	
C4. Cable Management	PLB4S-C	B1.76	PLST30SC-D30	B1.74	PLT1M-XMR4Y	B1.119	
	PLB4S-M0	B1.76	PLST4HS25-TL300	B1.74	PLT1M-XMR5	B1.119	
	PLB4S-M30	B1.76	PLST50SC-D30	B1.74	PLT1M-XMR6	B1.119	
	PLC1.5I-S8-C	B1.26	PLT.6SM-C	B1.8	PLT1M-XMR7	B1.119	
	PLC1.5I-S8-C0	B1.27	PLT.6SM-C0	B1.10	PLT1M-XMR8	B1.119	
	PLC1.5I-S8-M30	B1.27	PLT.6SM-M30	B1.12	PLT1S-C	B1.8	
	PLC1M-S4-C	B1.26	PLT.7M-C	B1.8	PLT1S-C0	B1.10	
	PLC1M-S4-C0	B1.27	PLT.7M-M0	B1.10	PLT1S-M30	B1.12	
	PLC1M-S4-M30	B1.27	PLT.7M-M30	B1.12	PLT1S-M300	B1.13	
	PLC2H-S25-L	B1.26	PLT1.5I-C	B1.8	PLT2.5H-L	B1.8	
D1. Terminals	PLC2H-S25-TL0	B1.27	PLT1.5I-C0	B1.10	PLT2.5H-L0	B1.10	
	PLC2H-S25-TL30	B1.27	PLT1.5I-C30	B1.12	PLT2.5I-C	B1.8	
	PLC2S-S10-C	B1.26	PLT1.5I-M100	B1.17	PLT2.5I-C0	B1.10	
	PLC2S-S10-C0	B1.27	PLT1.5I-M109	B1.16	PLT2.5S-C	B1.8	
	PLC2S-S10-M30	B1.27	PLT1.5I-M120	B1.15	PLT2.5S-C0	B1.10	
	PLC2S-S6-C	B1.26	PLT1.5I-M300	B1.13	PLT2.5S-M30	B1.12	
	PLC2S-S6-C0	B1.27	PLT1.5I-M69	B1.14	PLT2EH-C	B1.9	
	PLC3S-S10-C	B1.26	PLT1.5M-C	B1.8	PLT2EH-Q0	B1.11	
	PLC3S-S10-C0	B1.27	PLT1.5M-C0	B1.10	PLT2H-L	B1.8	
	PLC4H-S25-L	B1.26	PLT1.5M-M30	B1.12	PLT2H-L0	B1.10	
D2. Power Connectors	PLC4H-S25-L0	B1.27	PLT1.5M-XMR	B1.119	PLT2H-TL100	B1.17	
	PLC4H-S25-TL30	B1.27	PLT1.5M-XMR0	B1.119	PLT2H-TL109	B1.16	
	PLC4S-S10-C	B1.26	PLT1.5M-XMR00	B1.119	PLT2H-TL30	B1.12	
	PLC4S-S10-C0	B1.27	PLT1.5M-XMR30	B1.119	PLT2H-TL300	B1.13	
	PLC4S-S10-M30	B1.27	PLT1.5S-C	B1.8	PLT2I-C	B1.8	
	PLD-11	E5.28	PLT1.5S-C0	B1.10	PLT2I-C0	B1.10	
	D3. Grounding Connectors	E1. Labeling Systems	E2. Labels	E3. Pre-Printed & Write-On Markers	E4. Permanent Identification	E5. Lockout/Tagout & Safety Solutions	F. Index

PANDUIT® ELECTRICAL SOLUTIONS

Part Number	Page Number
PLT2I-C30	B1.12
PLT2I-C76	B1.19
PLT2I-C86	B1.21
PLT2I-M300	B1.13
PLT2I-M69	B1.14
PLT2M-C	B1.8
PLT2M-C0	B1.10
PLT2M-M30	B1.12
PLT2M-M69	B1.14
PLT2S-C	B1.8
PLT2S-C0	B1.10
PLT2S-C30	B1.12
PLT2S-C702Y	B1.18
PLT2S-C71	B1.20
PLT2S-C76	B1.19
PLT2S-C86	B1.21
PLT2S-M100	B1.17
PLT2S-M109	B1.16
PLT2S-M120	B1.15
PLT2S-M300	B1.13
PLT2S-M39	B1.12
PLT2S-M60	B1.14
PLT2S-M69	B1.14
PLT2S-VMR	B1.120
PLT2S-VMR0	B1.120
PLT2S-VMR30	B1.120
PLT3EH-NB-C0	B1.11
PLT3H-L	B1.8
PLT3H-L0	B1.10
PLT3H-L76	B1.19
PLT3H-L86	B1.21
PLT3H-TL100	B1.17
PLT3H-TL109	B1.16
PLT3H-TL30	B1.12
PLT3I-C	B1.8
PLT3I-C0	B1.10
PLT3I-M30	B1.12
PLT3S-C	B1.8
PLT3S-C0	B1.10
PLT3S-C30	B1.12
PLT3S-C702Y	B1.18
PLT3S-C76	B1.19
PLT3S-C86	B1.21
PLT3S-M100	B1.17
PLT3S-M109	B1.16
PLT4.5S-C	B1.8
PLT4.5S-C0	B1.10
PLT4H-L	B1.8
PLT4H-L0	B1.10
PLT4H-L76	B1.19
PLT4H-L86	B1.21
PLT4H-TL100	B1.17
PLT4H-TL109	B1.16
PLT4H-TL120	B1.15
PLT4H-TL30	B1.12
PLT4H-TL300	B1.13
PLT4H-TL69	B1.14
PLT4I-C	B1.8
PLT4I-C0	B1.10
PLT4I-M30	B1.12
PLT4S-C	B1.8
PLT4S-C0	B1.10
PLT4S-C30	B1.12
PLT4S-C76	B1.19
PLT4S-C86	B1.21
PLT4S-M100	B1.17
PLT4S-M109	B1.16
PLT4S-M120	B1.15
PLT4S-M300	B1.13
PLT4S-M69	B1.14
PLT5EH-NB-C0	B1.11
PLT5EH-Q	B1.9
PLT5EH-Q0	B1.11
PLT5H-C30	B1.12
PLT5H-L	B1.8
PLT5H-L0	B1.10
PLT5S-C	B1.8
PLT5S-C0	B1.10
PLT5S-M30	B1.12
PLT6EH-NB-C0	B1.11
PLT6EH-Q	B1.9
PLT6EH-Q0	B1.11
PLT6H-C30	B1.12
PLT6H-L	B1.8
PLT6H-L0	B1.10
PLT6LH-L	B1.8

Part Number	Page Number
PLT6LH-L0	B1.10
PLT7LH-C30	B1.12
PLT7LH-L	B1.8
PLT7LH-L0	B1.10
PLT8EH-C	B1.9
PLT8EH-Q0	B1.11
PLT8H-C30	B1.12
PLT8H-L	B1.8
PLT8H-L0	B1.10
PLT8LH-C120	B1.15
PLT8LH-L	B1.8
PLT8LH-L0	B1.10
PLT9LH-C30	B1.12
PLT9LH-L	B1.8
PLT9LH-L0	B1.10
PLUP40S-D30	B1.32
PLUP40SE-D	B1.32
PLUP40SE-D30	B1.32
PLWP1.5I-C	B1.28
PLWP1.5I-D30	B1.29
PLWP1.5S-D	B1.28
PLWP1.5S-D30	B1.29
PLWP1.5SA-D	B1.28
PLWP1M-C	B1.28
PLWP1M-D0	B1.29
PLWP1M-D30	B1.29
PLWP1S-C	B1.28
PLWP1S-C0	B1.29
PLWP1S-D30	B1.29
PLWP1SA-D	B1.28
PLWP1SB-D	B1.28
PLWP2H-TL	B1.28
PLWP2H-TL0	B1.29
PLWP2H-TL30	B1.29
PLWP2S-C	B1.28
PLWP2S-C0	B1.29
PLWP2S-D30	B1.29
PLWP2SA-D	B1.28
PLWP2SB-D	B1.28
PLWP30SC-D30	B1.31
PLWP3H-TL	B1.28
PLWP3H-TL0	B1.29
PLWP40SC-D30	B1.31
PLWP40SD-D30	B1.31
PLWP50SC-D30	B1.31
PLWP50SE-D30	B1.31
PM1-3F-C	D1.36
PM1-3R-C	D1.34
PM1-4F-C	D1.36
PM1-4R-C	D1.34
PM1-5F-C	D1.36
PM1-5R-C	D1.34
PM1-P10-C	D1.60
PM2-3F-C	D1.36
PM2-3R-C	D1.34
PM2-4F-C	D1.36
PM2-4R-C	D1.34
PM2-5F-C	D1.36
PM2-5R-C	D1.34
PM2-P10-C	D1.60
PM2H25-C	B2.19
PM2H25-M0	B2.19
PM2H25-M30	B2.19
PM6-3R-L	D1.34
PM6-4R-L	D1.34
PM6-5F-L	D1.36
PM6-5R-L	D1.34
PM6-6F-L	D1.36
PM6-6R-L	D1.34
PM6-8R-L	D1.34
PM6-P10-L	D1.60
PMCC38H25-C	B2.31
PMCC38H25-M0	B2.31
PMD	E3.9
PMD-0-9	E3.9
PMD-NEMA	E3.9
PMDR-0	E3.10
PMDR-0-9	E3.10
PMDR-9	E3.10
PMDR-90-99	E3.10
PMDR-A	E3.10
PMDR-BL	E3.10
PMDR-BLK	E3.10
PMDR-BRN	E3.10
PMDR-GRN	E3.10
PMDR-GRS	E3.10

Part Number	Page Number
PMDR-GRY	E3.10
PMDR-L1	E3.10
PMDR-L3	E3.10
PMDR-MIN	E3.10
PMDR-NEMA	E3.10
PMDR-ORN	E3.10
PMDR-PLS	E3.10
PMDR-PUR	E3.10
PMDR-RED	E3.10
PMDR-T1	E3.10
PMDR-T3	E3.10
PMDR-WHT	E3.10
PMDR-YEL	E3.10
PMDR-Z	E3.10
PMN1-35R-3K	D1.116
PMN1-3F-3K	D1.119
PMN1-3R-3K	D1.116
PMN1-4F-3K	D1.119
PMN1-4R-3K	D1.116
PMN1-5F-3K	D1.119
PMN1-5R-3K	D1.116
PMN1-6F-3K	D1.119
PMN1-6R-3K	D1.116
PMN2-35R-3K	D1.116
PMN2-3F-3K	D1.119
PMN2-3R-3K	D1.116
PMN2-4F-3K	D1.119
PMN2-4R-3K	D1.116
PMN2-5F-3K	D1.119
PMN2-5R-3K	D1.116
PMN2-6F-3K	D1.119
PMN2-6R-3K	D1.116
PMN6-35R-2K	D1.116
PMN6-3R-2K	D1.116
PMN6-4F-2K	D1.119
PMN6-4R-2K	D1.116
PMN6-5F-2K	D1.119
PMN6-5R-2K	D1.116
PMN6-6F-2K	D1.119
PMN6-6R-2K	D1.116
PMN6-8R-2K	D1.116
PMNF1-35R-3K	D1.117
PMNF1-3F-3K	D1.119
PMNF1-3F-C	D1.35
PMNF1-3R-3K	D1.117
PMNF1-3R-C	D1.33
PMNF1-4F-3K	D1.119
PMNF1-4F-C	D1.35
PMNF1-4R-3K	D1.117
PMNF1-4R-C	D1.33
PMNF1-5F-3K	D1.119
PMNF1-5F-C	D1.35
PMNF1-5R-3K	D1.117
PMNF1-5R-C	D1.33
PMNF1-6F-3K	D1.119
PMNF1-6F-C	D1.35
PMNF1-6R-3K	D1.117
PMNF1-6R-C	D1.33
PMNF2-35R-3K	D1.117
PMNF2-3F-3K	D1.119
PMNF2-3F-C	D1.35
PMNF2-3R-3K	D1.117
PMNF2-3R-C	D1.33
PMNF2-4F-3K	D1.119
PMNF2-4F-C	D1.35
PMNF2-4R-3K	D1.117
PMNF2-4R-C	D1.33
PMNF2-5F-3K	D1.119
PMNF2-5F-C	D1.35
PMNF2-5R-3K	D1.117
PMNF2-5R-C	D1.33
PMNF2-6F-3K	D1.119
PMNF2-6F-C	D1.35
PMNF2-6R-3K	D1.117
PMNF2-6R-C	D1.33
PMNF6-35R-2K	D1.117
PMNF6-3R-2K	D1.117
PMNF6-3R-L	D1.33
PMNF6-4F-2K	D1.119
PMNF6-4F-L	D1.35
PMNF6-4R-2K	D1.117
PMNF6-4R-L	D1.33
PMNF6-5F-2K	D1.119
PMNF6-5F-L	D1.35
PMNF6-5R-2K	D1.117
PMNF6-5R-L	D1.33

A. System Overview

B1. Cable Ties

B2. Cable Accessories

B3. Stainless Steel Ties

C1. Wiring Duct

C2. Surface Raceway

C3. Abrasion Protection

C4. Cable Management

D1. Terminals

D2. Power Connectors

D3. Grounding Connectors

E1. Labeling Systems

E2. Labels

E3. Pre-Printed & Write-On Markers

E4. Permanent Identification

E5. Lockout/Tagout & Safety Solutions

F. Index

PANDUIT® ELECTRICAL SOLUTIONS

A. System Overview	Part Number	Page Number	Part Number	Page Number	Part Number	Page Number
B1. Cable Ties	PMNF6-6F-2K	D1.119	PMR5WPB-X	C2.11	PN10-14RX-L	D1.7
	PMNF6-6F-L	D1.35	PMR7CCWH-X	C2.12	PN10-14SLF-L	D1.26
	PMNF6-6R-2K	D1.117	PMR7DAWH	C2.12	PN10-38R-2K	D1.103
	PMNF6-6R-L	D1.33	PMR7ICWH	C2.12	PN10-38R-L	D1.6
	PMNF6-8R-2K	D1.117	PMR7MSWH-X	C2.11	PN10-38RX-L	D1.7
	PMNF6-8R-L	D1.33	PMR7OCWH	C2.12	PN10-56R-2K	D1.103
	PMR40BC	C2.5	PMR7RAWH	C2.12	PN10-56R-L	D1.6
	PMR40BFWH	C2.6	PMR7TRWH	C2.12	PN10-56RX-L	D1.7
	PMR40BWH10	C2.5	PMR7WH10	C2.11	PN10-5SLF-L	D1.26
	PMR40CWH13.75	C2.5	PMR7WH5	C2.11	PN10-610R-L	D1.9
PMR40CWH19.75	C2.5	PMR7WPB-X	C2.11	PN10-6F-2K	D1.107	
PMR40CWH31.75	C2.5	PMRTUPAL	C2.13	PN10-6F-L	D1.21	
PMR40CWH5	C2.5	PMRTUPWH	C2.13	PN10-6LF-2K	D1.110	
PMR40CWH7.75	C2.5	PMV1-35RB-3K	D1.118	PN10-6LF-L	D1.24	
PMR40DB50	C2.6	PMV1-3FB-3K	D1.120	PN10-6R-2K	D1.103	
PMR40DC-X	C2.5	PMV1-3FB-CY	D1.35	PN10-6R-L	D1.6	
PMR40DP50WH	C2.6	PMV1-3RB-3K	D1.118	PN10-6RX-L	D1.7	
PMR40DW5	C2.5	PMV1-3RB-CY	D1.34	PN10-6SLF-L	D1.26	
PMR40E45EWH	C2.6	PMV1-4FB-3K	D1.120	PN10-8F-2K	D1.107	
PMR40ECWH	C2.6	PMV1-4FB-CY	D1.35	PN10-8F-L	D1.21	
PMR40EEWH	C2.6	PMV1-4RB-3K	D1.118	PN10-8FF-2K	D1.113	
PMR40FH2WH	C2.6	PMV1-4RB-CY	D1.34	PN10-8FF-L	D1.28	
PMR40FH4WH	C2.6	PMV1-5FB-3K	D1.120	PN10-8LF-2K	D1.110	
PMR40I45EWH	C2.6	PMV1-5FB-CY	D1.35	PN10-8LF-L	D1.24	
PMR40ICC	C2.6	PMV1-5RB-3K	D1.118	PN10-8R-2K	D1.103	
PMR40ICWH	C2.6	PMV1-5RB-CY	D1.34	PN10-8R-L	D1.6	
PMR40KH2WH	C2.6	PMV1-6FB-3K	D1.120	PN10-8RX-L	D1.7	
PMR40KH4WH	C2.6	PMV1-6FB-CY	D1.35	PN10-8SLF-2K	D1.112	
PMR40OCWH	C2.6	PMV1-6RB-3K	D1.118	PN10-8SLF-L	D1.26	
PMR40PCWH	C2.6	PMV1-6RB-CY	D1.34	PN12-10HDR-2K	D1.106	
PMR40RAWH	C2.5	PMV1-P10-CY	D1.60	PN12-10HDR-L	D1.13	
PMR40SIC	C2.5	PMV1-P12B-3K	D1.138	PN12-14HDR-2K	D1.106	
PMR40SOCWH	C2.6	PMV2-35RB-3K	D1.118	PN12-14HDR-L	D1.13	
PMR40T50	C2.6	PMV2-3FB-3K	D1.120	PN12-38HDR-2K	D1.106	
PMR40TRWH	C2.6	PMV2-3FB-C	D1.35	PN12-38HDR-L	D1.13	
PMR40TWH	C2.6	PMV2-3RB-3K	D1.118	PN12-56HDR-2K	D1.106	
PMR40WR-X	C2.6	PMV2-3RB-C	D1.34	PN12-56HDR-L	D1.13	
PMR5737AWH	C2.16	PMV2-4FB-3K	D1.120	PN12-6HDR-2K	D1.106	
PMR5737WH	C2.16	PMV2-4FB-C	D1.35	PN12-8HDR-2K	D1.106	
PMR5738AWH	C2.16	PMV2-4RB-3K	D1.118	PN12-8HDR-L	D1.13	
PMR5738WH	C2.16	PMV2-4RB-C	D1.34	PN14-10F-3K	D1.107	
PMR5739AWH	C2.16	PMV2-5FB-3K	D1.120	PN14-10F-C	D1.21	
PMR5739WH	C2.16	PMV2-5FB-C	D1.35	PN14-10FF-3K	D1.113	
PMR5744-2WH	C2.16	PMV2-5RB-3K	D1.118	PN14-10FF-C	D1.28	
PMR5744-3WH	C2.16	PMV2-5RB-C	D1.34	PN14-10FN-3K	D1.107	
PMR5744S-2WH	C2.15	PMV2-6FB-3K	D1.120	PN14-10FN-C	D1.21	
PMR5744S-3WH	C2.16	PMV2-6FB-C	D1.35	PN14-10LF-3K	D1.110	
PMR5744SWH	C2.15	PMV2-6RB-3K	D1.118	PN14-10LF-C	D1.24	
PMR5744WH	C2.16	PMV2-6RB-C	D1.34	PN14-10LFN-C	D1.24	
PMR5747-2WH	C2.15	PMV2-P10-C	D1.60	PN14-10R-3K	D1.103	
PMR5747-3WH	C2.15	PMV2-P12B-3K	D1.138	PN14-10R-C	D1.6	
PMR5747WH	C2.15	PMV6-35RB-2K	D1.118	PN14-10RX-C	D1.7	
PMR5748-2WH	C2.15	PMV6-3R-L	D1.34	PN14-10SLF-3K	D1.112	
PMR5748-3WH	C2.15	PMV6-3RB-2K	D1.118	PN14-10SLF-C	D1.26	
PMR5748WH	C2.15	PMV6-4F-L	D1.35	PN14-12R-L	D1.6	
PMR5751-2WH	C2.15	PMV6-4FB-2K	D1.120	PN14-14F-3K	D1.107	
PMR5751-3WH	C2.15	PMV6-4R-L	D1.34	PN14-14F-C	D1.21	
PMR5751WH	C2.15	PMV6-4RB-2K	D1.118	PN14-14R-3K	D1.103	
PMR5752RD	C2.16	PMV6-5F-L	D1.35	PN14-14R-C	D1.6	
PMR5753RD	C2.16	PMV6-5FB-2K	D1.120	PN14-14RX-C	D1.7	
PMR5760WH	C2.15	PMV6-5R-L	D1.34	PN14-14SLF-C	D1.26	
PMR57AOCWH	C2.12	PMV6-5RB-2K	D1.118	PN14-38R-L	D1.6	
PMR57CBWH	C2.12	PMV6-6F-L	D1.35	PN14-4R-3K	D1.103	
PMR57CC50-X	C2.12	PMV6-6FB-2K	D1.120	PN14-4R-C	D1.6	
PMR57CC75-X	C2.12	PMV6-6R-L	D1.34	PN14-56R-C	D1.6	
PMR57EBCWH	C2.12	PMV6-6RB-2K	D1.118	PN14-5SLF-3K	D1.112	
PMR57ECCWH	C2.12	PMV6-8R-L	D1.34	PN14-5SLF-C	D1.26	
PMR57EEWH	C2.12	PMV6-8RB-2K	D1.118	PN14-610R-C	D1.9	
PMR57GC-X	C2.11	PMV6-P10-L	D1.60	PN14-6F-3K	D1.107	
PMR57JBC50-X	C2.12	PN10-10F-2K	D1.107	PN14-6F-C	D1.21	
PMR57JBC75-X	C2.12	PN10-10F-L	D1.21	PN14-6FF-3K	D1.113	
PMR57JC-X	C2.12	PN10-10FF-2K	D1.113	PN14-6FF-C	D1.28	
PMR57LTEWH	C2.11	PN10-10FF-L	D1.28	PN14-6FN-3K	D1.107	
PMR57MRT	C2.13	PN10-10LF-2K	D1.110	PN14-6FN-C	D1.21	
PMR57RTEWH	C2.12	PN10-10LF-L	D1.24	PN14-6LF-3K	D1.110	
PMR57SC-X	C2.11	PN10-10R-2K	D1.103	PN14-6LF-C	D1.24	
PMR57TWH	C2.12	PN10-10R-L	D1.6	PN14-6LFW-C	D1.24	
PMR5CCWH-X	C2.12	PN10-10RX-L	D1.7	PN14-6R-3K	D1.103	
PMR5DAWH	C2.12	PN10-10SLF-2K	D1.112	PN14-6R-C	D1.6	
PMR5ICWH	C2.12	PN10-10SLF-L	D1.26	PN14-6RN-3K	D1.103	
PMR5MSWH-X	C2.11	PN10-12R-L	D1.6	PN14-6RN-C	D1.6	
PMR5OCWH	C2.12	PN10-14F-2K	D1.107	PN14-6RX-C	D1.7	
PMR5RAWH	C2.12	PN10-14F-L	D1.21	PN14-6SLF-3K	D1.112	
PMR5TRWH	C2.12	PN10-14LF-L	D1.24	PN14-6SLF-C	D1.26	
PMR5WH10	C2.11	PN10-14R-2K	D1.103	PN14-8F-3K	D1.107	
PMR5WH5	C2.11	PN10-14R-L	D1.6	PN14-8F-C	D1.21	

Part Number	Page Number
PN14-8FF-3K	D1.113
PN14-8FF-C	D1.28
PN14-8LF-3K	D1.110
PN14-8LF-C	D1.24
PN14-8R-3K	D1.103
PN14-8R-C	D1.6
PN14-8RX-C	D1.7
PN14-8SLF-3K	D1.112
PN14-8SLF-C	D1.26
PN18-10F-3K	D1.107
PN18-10F-C	D1.21
PN18-10FF-3K	D1.113
PN18-10FF-C	D1.28
PN18-10FN-3K	D1.107
PN18-10FN-C	D1.21
PN18-10LF-3K	D1.110
PN18-10LF-C	D1.24
PN18-10LFN-C	D1.24
PN18-10R-3K	D1.103
PN18-10R-C	D1.6
PN18-10SLF-3K	D1.112
PN18-10SLF-C	D1.26
PN18-12R-C	D1.6
PN18-14F-3K	D1.107
PN18-14F-C	D1.21
PN18-14R-3K	D1.103
PN18-14R-C	D1.6
PN18-38R-C	D1.6
PN18-4R-3K	D1.103
PN18-4R-C	D1.6
PN18-4RN-C	D1.6
PN18-56R-C	D1.6
PN18-5SLF-3K	D1.112
PN18-5SLF-C	D1.26
PN18-610R-C	D1.9
PN18-6F-3K	D1.107
PN18-6F-C	D1.21
PN18-6FF-3K	D1.113
PN18-6FF-C	D1.28
PN18-6FN-3K	D1.107
PN18-6FN-C	D1.21
PN18-6LF-3K	D1.110
PN18-6LF-C	D1.24
PN18-6LFW-C	D1.24
PN18-6R-3K	D1.103
PN18-6R-C	D1.6
PN18-6RN-3K	D1.103
PN18-6RN-C	D1.6
PN18-6SLF-3K	D1.112
PN18-6SLF-C	D1.26
PN18-8F-3K	D1.107
PN18-8F-C	D1.21
PN18-8FF-3K	D1.113
PN18-8FF-C	D1.28
PN18-8LF-3K	D1.110
PN18-8LF-C	D1.24
PN18-8R-3K	D1.103
PN18-8R-C	D1.6
PN18-8SLF-3K	D1.112
PN18-8SLF-C	D1.26
PN22-10R-C	D1.6
PN22-2F-C	D1.21
PN22-2R-C	D1.6
PN22-4F-C	D1.21
PN22-4R-C	D1.6
PN22-6F-C	D1.21
PN22-6R-C	D1.6
PN22-8R-C	D1.6
PNF10-10F-2K	D1.108
PNF10-10F-L	D1.22
PNF10-10FF-2K	D1.114
PNF10-10LF-2K	D1.110
PNF10-10LF-L	D1.25
PNF10-10R-2K	D1.104
PNF10-10R-L	D1.8
PNF10-10SLF-2K	D1.112
PNF10-10SLF-L	D1.27
PNF10-14F-2K	D1.108
PNF10-14F-L	D1.22
PNF10-14R-2K	D1.104
PNF10-14R-L	D1.8
PNF10-14SLF-L	D1.27
PNF10-38R-2K	D1.104
PNF10-38R-L	D1.8

Part Number	Page Number
PNF10-56R-2K	D1.104
PNF10-56R-L	D1.8
PNF10-6F-2K	D1.108
PNF10-6F-L	D1.22
PNF10-6LF-2K	D1.110
PNF10-6LF-L	D1.25
PNF10-6R-2K	D1.104
PNF10-6R-L	D1.8
PNF10-6SLF-2K	D1.112
PNF10-6SLF-L	D1.27
PNF10-8F-2K	D1.108
PNF10-8F-L	D1.22
PNF10-8FF-2K	D1.114
PNF10-8LF-2K	D1.110
PNF10-8LF-L	D1.25
PNF10-8R-2K	D1.104
PNF10-8R-L	D1.8
PNF10-8SLF-2K	D1.112
PNF10-8SLF-L	D1.27
PNF14-10F-3K	D1.108
PNF14-10F-C	D1.22
PNF14-10FF-3K	D1.114
PNF14-10LF-3K	D1.110
PNF14-10LF-C	D1.25
PNF14-10LFN-3K	D1.110
PNF14-10R-3K	D1.104
PNF14-10R-C	D1.8
PNF14-10SLF-3K	D1.112
PNF14-10SLF-C	D1.27
PNF14-14F-3K	D1.108
PNF14-14F-C	D1.22
PNF14-14R-3K	D1.104
PNF14-14R-C	D1.8
PNF14-14SLF-C	D1.27
PNF14-38R-L	D1.8
PNF14-4R-3K	D1.104
PNF14-4R-C	D1.8
PNF14-56R-C	D1.8
PNF14-5SLF-C	D1.27
PNF14-6F-3K	D1.108
PNF14-6F-C	D1.22
PNF14-6FF-3K	D1.114
PNF14-6FN-3K	D1.108
PNF14-6LF-3K	D1.110
PNF14-6LF-C	D1.25
PNF14-6LFW-C	D1.25
PNF14-6R-3K	D1.104
PNF14-6R-C	D1.8
PNF14-6RN-3K	D1.104
PNF14-6RN-C	D1.8
PNF14-6SLF-3K	D1.112
PNF14-6SLF-C	D1.27
PNF14-8F-3K	D1.108
PNF14-8F-C	D1.22
PNF14-8FF-3K	D1.114
PNF14-8LF-C	D1.25
PNF14-8R-3K	D1.104
PNF14-8R-C	D1.8
PNF14-8SLF-C	D1.27
PNF18-10F-3K	D1.108
PNF18-10F-C	D1.22
PNF18-10FF-3K	D1.114
PNF18-10LF-3K	D1.110
PNF18-10LF-C	D1.25
PNF18-10R-3K	D1.104
PNF18-10R-C	D1.8
PNF18-10SLF-3K	D1.112
PNF18-10SLF-C	D1.27
PNF18-14F-3K	D1.108
PNF18-14F-C	D1.22
PNF18-14R-3K	D1.104
PNF18-14R-C	D1.8
PNF18-38R-C	D1.8
PNF18-4R-3K	D1.104
PNF18-4R-C	D1.8
PNF18-4RN-3K	D1.104
PNF18-56R-C	D1.8
PNF18-5SLF-3K	D1.112
PNF18-5SLF-C	D1.27
PNF18-6F-3K	D1.108
PNF18-6F-C	D1.22
PNF18-6FF-3K	D1.114
PNF18-6FN-3K	D1.108
PNF18-6LF-3K	D1.110
PNF18-6LF-C	D1.25

Part Number	Page Number
PNF18-6LFW-3K	D1.110
PNF18-6LFW-C	D1.25
PNF18-6R-3K	D1.104
PNF18-6R-C	D1.8
PNF18-6RN-3K	D1.104
PNF18-6RN-C	D1.8
PNF18-6SLF-3K	D1.112
PNF18-6SLF-C	D1.27
PNF18-8F-3K	D1.108
PNF18-8F-C	D1.22
PNF18-8FF-3K	D1.114
PNF18-8LF-3K	D1.110
PNF18-8LF-C	D1.25
PNF18-8R-3K	D1.104
PNF18-8R-C	D1.8
PNF18-8SLF-3K	D1.112
PNF18-8SLF-C	D1.27
PNL-1000-2-3	D2.137
PNL-1000-3	D2.135
PNL-1/0-L	D2.135
PNL-1/0-2-L	D2.137
PNL-250-2-Q	D2.137
PNL-250-Q	D2.135
PNL-4-C	D2.135
PNL-500-2-3	D2.137
PNL-500-3	D2.135
PNL-8-C	D2.135
PNLC-1/0-3	D2.141
PNLC-250-1	D2.141
PNLC-500-1	D2.141
PP1S-S10-X	B2.23
PP1S-S12-X	B2.23
PP2S-S10-X	B2.23
PP2S-S12-X	B2.23
PP5X50F	B1.83
PPC25X50	B1.83
PPC25X50F	B1.83
PPF2S-S25-V	B2.24, C4.11
PPF2S-S25-V69	B2.24, C4.11
PPF2SV-S25-V	B2.24, C4.11
PPF2SV-S25-V69	B2.24, C4.11
PPH10	B1.111, B3.16
PPM-0	E3.8
PPM-1-33	E3.8
PPM-A	E3.8
PPS0305W2200	E5.23
PPS0507W2200	E5.23
PPS0710G001	E5.23
PPS0710G020	E5.23
PPS1014G002	E5.23
PPS1209G010	E5.23
PPS1209G011	E5.23
PPS1209G012	E5.23
PPTMT	B3.16
PRA2S-A-Q	B2.6
PRL100BY-0	E5.36
PRL100BY-18KIT	E5.36
PRL100BY-36KIT	E5.36
PRL100BY-9	E5.36
PRL100BY-A	E5.36
PRL100BY-BLNK	E5.36
PRL100BY-DSH	E5.36
PRL100BY-Z	E5.36
PRL150YB-0	E5.36
PRL150YB-9	E5.36
PRL150YB-A	E5.36
PRL150YB-DSH	E5.36
PRL150YB-Z	E5.36
PRL250YB-0	E5.36
PRL250YB-9	E5.36
PRL250YB-A	E5.36
PRL250YB-DSH	E5.36
PRL250YB-Z	E5.36
PRLWP30S-D30	B1.32
PRLWP50S-D30	B1.32
PROG-CCCD	E1.14
PROG-EMCD	E1.14
PROG-EMCD3	E1.14
PRST30S-S14-M30	B1.75
PRST40SC-D30	B1.74
PRT1.5S-C	B1.22
PRT1.5S-C0	B1.23
PRT1.5S-M30	B1.23
PRT10EH-C	B1.22
PRT10EH-Q0	B1.24
PRT12EH-C	B1.22

A. System Overview
B1. Cable Ties
B2. Cable Accessories
B3. Stainless Steel Ties
C1. Wiring Duct
C2. Surface Raceway
C3. Abrasion Protection
C4. Cable Management
D1. Terminals
D2. Power Connectors
D3. Grounding Connectors
E1. Labeling Systems
E2. Labels
E3. Pre-Printed & Write-On Markers
E4. Permanent Identification
E5. Lockout/Tagout & Safety Solutions
F. Index

PANDUIT® ELECTRICAL SOLUTIONS

A. System Overview	Part Number	Page Number	Part Number	Page Number	Part Number	Page Number
B1. Cable Ties	PRT12EH-Q0	B1.24	PSL-4BLK	E5.11	PSL-SC	E5.14
	PRT15S-C	B1.22	PSL-4BLK-LB	E5.11	PSL-STATION	E5.9
	PRT15S-C0	B1.23	PSL-4BLU	E5.11	PSL-STEPS	E5.3
	PRT2EH-C	B1.22	PSL-4BLU-LB	E5.11	PSL-TG1	E5.14
	PRT2EH-C100	B1.25	PSL-4GRN	E5.11	PSL-V13	E5.5
B2. Cable Accessories	PRT2EH-Q0	B1.24	PSL-4GRN-LB	E5.11	PSL-V2A	E5.5
	PRT2H-L	B1.22	PSL-4ORG	E5.11	PSL-V6A	E5.5
	PRT2H-L0	B1.23	PSL-4ORG-LB	E5.11	PSL-V9	E5.5
	PRT2S-C	B1.22	PSL-4PRP	E5.11	PSL-VS	E5.5
	PRT2S-C0	B1.23	PSL-4PRP-LB	E5.11	PSL-WS1A	E5.5
B3. Stainless Steel Ties	PRT3H-L	B1.22	PSL-4RED	E5.11	PSM-0-9-Y	E3.7
	PRT3H-L0	B1.23	PSL-4RED-LB	E5.11	PSM-0-Y	E3.7
	PRT3S-C	B1.22	PSL-4S	E5.9	PSM-1-33-Y	E3.7
	PRT3S-C0	B1.23	PSL-4SWC	E5.9	PSM-34-66-Y	E3.7
	PRT4H-L	B1.22	PSL-4TEL	E5.11	PSM-67-99-Y	E3.7
C1. Wiring Duct	PRT4H-L0	B1.23	PSL-4TEL-LB	E5.11	PSM-A-Y	E3.7
	PRT4S-C	B1.22	PSL-4YEL	E5.11	PSM-A-Z-Y	E3.7
	PRT4S-C0	B1.23	PSL-4YEL-LB	E5.11	PSN12-L	D1.66
	PRT5EH-C100	B1.25	PSL-5BLK	E5.12	PSN16-C	D1.66
	PRT5EH-Q	B1.22	PSL-5BLU	E5.12	PSN18-C	D1.66
C2. Surface Raceway	PRT5EH-Q0	B1.24	PSL-5GRN	E5.12	PSSB-13	E5.31
	PRT6EH-C100	B1.25	PSL-5RED	E5.12	PSWM-1500Y	E3.9
	PRT6EH-Q	B1.22	PSL-5RED-LS	E5.12	PSWM-375Y	E3.9
	PRT6EH-Q0	B1.24	PSL-5WHT	E5.12	PSWM-750Y	E3.9
	PRT8EH-C	B1.22	PSL-5YEL	E5.12	PSWMH-375Y	E3.9
C3. Abrasion Protection	PRT8EH-C100	B1.25	PSL-BV1	E5.6	PSWMH-750Y	E3.9
	PRT8EH-Q0	B1.24	PSL-BV2	E5.6	PT10-10R-L	D1.12
	PRWP1.5S-D	B1.30	PSL-CB	E5.3	PT10-14R-L	D1.12
	PRWP1.5S-D0	B1.30	PSL-CBIL	E5.3	PT10-6R-L	D1.12
	PRWP1.5S-D30	B1.30	PSL-CBILNT	E5.3	PT10-8R-L	D1.12
C4. Cable Management	PRWP1S-C	B1.30	PSL-CBL	E5.4	PT14-10R-C	D1.12
	PRWP1S-D0	B1.30	PSL-CBNT	E5.3	PT14-14R-C	D1.12
	PRWP1SA-D	B1.30	PSL-CBWL	E5.10	PT14-4R-C	D1.12
	PRWP1SB-D	B1.30	PSL-CL110	E5.4	PT14-6R-C	D1.12
	PRWP2H-TL	B1.30	PSL-CL480	E5.4	PT14-8R-C	D1.12
D1. Terminals	PRWP2S-D	B1.30	PSL-DCJB	E5.7	PT18-10R-C	D1.12
	PRWP2S-D0	B1.30	PSL-DCJB-BL	E5.7	PT18-4R-C	D1.12
	PS12-L	D1.67	PSL-DCJB-BU	E5.7	PT18-6R-C	D1.12
	PS16-C	D1.67	PSL-DCJB-GR	E5.7	PT18-8R-C	D1.12
	PS18-C	D1.67	PSL-DCJB-IW	E5.7	PT2S-ARW	E5.32
D2. Power Connectors	PSCBLK-Q	D2.64	PSL-DCJB-YL	E5.7	PT2S-BLK	E5.32
	PSCBLU-L	D2.64	PSL-DCPL	E5.7	PT2S-RED	E5.32
	PSCBRN-L	D2.64	PSL-DCPL-BL	E5.7	PTH	B1.111
	PSCC-3	E3.9	PSL-DCPL-BU	E5.7	PTR-CLN	E1.11
	PSCC-3Y	E3.9	PSL-DCPL-GR	E5.7	PTS	B1.111
D3. Grounding Connectors	PSCC-5Y	E3.9	PSL-DCPL-IW	E5.7	PUM-049-2S-D30	B2.22
	PSCGRN-L	D2.64	PSL-DCPL-YL	E5.7	PUM-049-M30	B2.22
	PSCGRY-L	D2.64	PSL-DCPLR	E5.7	PUM-071-2S-D30	B2.22
	PSCORG-Q	D2.64	PSL-DCPLR-BL	E5.7	PUM-071-M30	B2.22
	PSCPNK-L	D2.64	PSL-DCPLR-BU	E5.7	PUM-100-2S-D30	B2.22
E1. Labeling Systems	PSCPUR-Q	D2.64	PSL-DCPLR-GR	E5.7	PUM-100-M30	B2.22
	PSCRED-L	D2.64	PSL-DCPLR-IW	E5.7	PUM-925-2S-D30	B2.22
	PSCYEL-Q	D2.64	PSL-DCPLR-YL	E5.7	PUM-925-M30	B2.22
	PSJBXIW	C2.58	PSL-ERB	E5.5	PV10-10F-L	D1.23
	PSL-1	E5.13	PSL-GLB	E5.9	PV10-10FB-2K	D1.109
E2. Labels	PSL-1.5	E5.13	PSL-HD1	E5.13	PV10-10FF-L	D1.28
	PSL-1.5A	E5.13	PSL-HD2.4	E5.13	PV10-10FFB-2K	D1.114
	PSL-10S	E5.9	PSL-HD3	E5.13	PV10-10FX-L	D1.24
	PSL-10SWC	E5.9	PSL-KT-CONA	E5.8	PV10-10LF-L	D1.25
	PSL-11BLK	E5.11	PSL-KT-MROA	E5.8	PV10-10LFB-2K	D1.111
E3. Pre-Printed & Write-On Markers	PSL-11BLK-LS	E5.11	PSL-KT-PWR	E5.8	PV10-10LFX-L	D1.26
	PSL-11BLU	E5.11	PSL-LCM	E5.2	PV10-10R-L	D1.10
	PSL-11BLU-LS	E5.11	PSL-LTM	E5.2	PV10-10RB-2K	D1.105
	PSL-11GRN	E5.11	PSL-LTMGP	E5.2	PV10-10RX-L	D1.11
	PSL-11GRN-LS	E5.11	PSL-LTMS	E5.2	PV10-10SLF-L	D1.27
E4. Permanent Identification	PSL-11ORNG	E5.11	PSL-LTP	E5.2	PV10-10SLFB-2K	D1.113
	PSL-11ORNG-LS	E5.11	PSL-LTPGP	E5.2	PV10-12R-L	D1.10
	PSL-11RED	E5.11	PSL-LTPS	E5.2	PV10-14F-L	D1.23
	PSL-11RED-LS	E5.11	PSL-LTV	E5.2	PV10-14FB-2K	D1.109
	PSL-11YEL	E5.11	PSL-LTV-DVD	E5.2	PV10-14FX-L	D1.24
E5. Lockout/Tagout & Safety Solutions	PSL-11YEL-LS	E5.11	PSL-MLD	E5.6, E5.13	PV10-14LF-L	D1.25
	PSL-1A	E5.13	PSL-MLDC	E5.6	PV10-14LFB-2K	D1.111
	PSL-20S	E5.9	PSL-MLDC200	E5.6	PV10-14LFX-L	D1.26
	PSL-20SWC	E5.9	PSL-MLDH-X	E5.6, E5.13	PV10-14R-L	D1.10
	PSL-3BLACK	E5.12	PSL-P	E5.4	PV10-14RB-2K	D1.105
F. Index	PSL-3BLACK-LS	E5.12	PSL-PC	E5.14	PV10-14RX-L	D1.11
	PSL-3BLUE	E5.12	PSL-PE1	E5.14	PV10-14SLF-L	D1.27
	PSL-3BLUE-LS	E5.12	PSL-PE2	E5.14	PV10-38R-L	D1.10
	PSL-3GREEN	E5.12	PSL-PEL	E5.6	PV10-38RB-2K	D1.105
	PSL-3GREEN-LS	E5.12	PSL-PK-EA	E5.8	PV10-38RX-L	D1.11
PSL-3RED	E5.12	PSL-PL1BLKY	E5.13	PV10-56R-L	D1.10	
PSL-3RED-LS	E5.12	PSL-PL1BLUY	E5.13	PV10-56RB-2K	D1.105	
PSL-3WHITE	E5.12	PSL-PL1GRNY	E5.13	PV10-56RX-L	D1.11	
PSL-3WHITE-LS	E5.12	PSL-PL1REDY	E5.13	PV10-5SLF-L	D1.27	
PSL-3YELLOW	E5.12	PSL-PL1WHTY	E5.13	PV10-610R-L	D1.12	
PSL-3YELLOW-LS	E5.12	PSL-PL1YELY	E5.13	PV10-610RB-2K	D1.105	

PANDUIT® ELECTRICAL SOLUTIONS

Part Number	Page Number	Part Number	Page Number	Part Number	Page Number
PV10-6F-L	D1.23	PV14-6LFB-3K	D1.111	PV18-8LFX-CY	D1.26
PV10-6FB-2K	D1.109	PV14-6LFW-C	D1.25	PV18-8R-CY	D1.10
PV10-6LF-L	D1.25	PV14-6LFWB-3K	D1.111	PV18-8RB-3K	D1.105
PV10-6LFB-2K	D1.111	PV14-6LFX-C	D1.26	PV18-8RX-CY	D1.11
PV10-6LFX-L	D1.26	PV14-6R-C	D1.10	PV18-8SLF-CY	D1.27
PV10-6R-L	D1.10	PV14-6RB-3K	D1.105	PV18-8SLFB-3K	D1.113
PV10-6RB-2K	D1.105	PV14-6RN-C	D1.10	PV18-P47-CY	D1.54
PV10-6RX-L	D1.11	PV14-6RNB-3K	D1.105	PV18-P47B-3K	D1.130
PV10-6SLF-L	D1.27	PV14-6RX-C	D1.11	PV2-10R-XY	D1.15
PV10-6SLFB-2K	D1.113	PV14-6SFF-C	D1.27	PV2-10RX-XY	D1.16
PV10-8F-L	D1.23	PV14-6SLFB-3K	D1.113	PV2-12R-XY	D1.15
PV10-8FB-2K	D1.109	PV14-8F-C	D1.23	PV2-12RX-XY	D1.16
PV10-8FF-L	D1.28	PV14-8FB-3K	D1.109	PV2-14R-XY	D1.15
PV10-8FFB-2K	D1.114	PV14-8FF-C	D1.28	PV2-14RX-XY	D1.16
PV10-8FX-L	D1.24	PV14-8FFB-3K	D1.114	PV2-38R-XY	D1.15
PV10-8LF-L	D1.25	PV14-8FX-C	D1.24	PV2-38RX-XY	D1.16
PV10-8LFB-2K	D1.111	PV14-8LF-C	D1.25	PV2-56R-XY	D1.15
PV10-8LFX-L	D1.26	PV14-8LFB-3K	D1.111	PV2-56RX-XY	D1.16
PV10-8R-L	D1.10	PV14-8LFX-C	D1.26	PV22-10R-C	D1.10
PV10-8RB-2K	D1.105	PV14-8R-C	D1.10	PV22-2F-C	D1.23
PV10-8RX-L	D1.11	PV14-8RB-3K	D1.105	PV22-2R-C	D1.10
PV10-8SLF-L	D1.27	PV14-8RX-C	D1.11	PV22-4F-C	D1.23
PV10-8SLFB-2K	D1.113	PV14-8SLF-C	D1.27	PV22-4R-C	D1.10
PV10-P55-L	D1.54	PV14-8SLFB-3K	D1.113	PV22-6F-C	D1.23
PV12-10HDR-L	D1.14	PV14-P47-C	D1.54	PV22-6R-C	D1.10
PV12-10HDRB-2K	D1.106	PV14-P47B-3K	D1.130	PV22-8R-C	D1.10
PV12-10HDRX-L	D1.14	PV18-10F-CY	D1.23	PV4-10R-E	D1.15
PV12-14HDR-L	D1.14	PV18-10FB-3K	D1.109	PV4-10RX-E	D1.16
PV12-14HDRB-2K	D1.106	PV18-10FF-CY	D1.28	PV4-12R-E	D1.15
PV12-14HDRX-L	D1.14	PV18-10FFB-3K	D1.114	PV4-12RX-E	D1.16
PV12-38HDR-L	D1.14	PV18-10FN-CY	D1.23	PV4-14R-E	D1.15
PV12-38HDRB-2K	D1.106	PV18-10FX-CY	D1.24	PV4-14RX-E	D1.16
PV12-38HDRX-L	D1.14	PV18-10LF-CY	D1.25	PV4-38R-E	D1.15
PV12-56HDR-L	D1.14	PV18-10LFB-3K	D1.111	PV4-38RX-E	D1.16
PV12-56HDRB-2K	D1.106	PV18-10LFN-CY	D1.25	PV4-56R-E	D1.15
PV12-56HDRX-L	D1.14	PV18-10LFNB-3K	D1.111	PV4-56RX-E	D1.16
PV12-6HDR-L	D1.14	PV18-10LFX-CY	D1.26	PV6-10R-E	D1.15
PV12-6HDRB-2K	D1.106	PV18-10R-CY	D1.10	PV6-10RX-E	D1.16
PV12-6HDRX-L	D1.14	PV18-10RB-3K	D1.105	PV6-12R-E	D1.15
PV12-8HDR-L	D1.14	PV18-10RX-CY	D1.11	PV6-12RX-E	D1.16
PV12-8HDRB-2K	D1.106	PV18-10SLF-CY	D1.27	PV6-14R-E	D1.15
PV12-8HDRX-L	D1.14	PV18-10SLFB-3K	D1.113	PV6-14RX-E	D1.16
PV14-10F-C	D1.23	PV18-12R-CY	D1.10	PV6-38R-E	D1.15
PV14-10FB-3K	D1.109	PV18-14FB-3K	D1.109	PV6-38RX-E	D1.16
PV14-10FF-C	D1.28	PV18-14R-CY	D1.10	PV6-56R-E	D1.15
PV14-10FFB-3K	D1.114	PV18-14RB-3K	D1.105	PV6-56RX-E	D1.16
PV14-10FN-C	D1.23	PV18-14RX-CY	D1.11	PV6-8R-E	D1.15
PV14-10FNB-3K	D1.109	PV18-38R-CY	D1.10	PV6-8RX-E	D1.16
PV14-10FX-C	D1.24	PV18-38RB-2K	D1.105	PV8-10R-QY	D1.15
PV14-10LF-C	D1.25	PV18-38RX-CY	D1.11	PV8-10RX-QY	D1.16
PV14-10LFB-3K	D1.111	PV18-4R-CY	D1.10	PV8-12R-QY	D1.15
PV14-10LFN-C	D1.25	PV18-4RB-3K	D1.105	PV8-12RX-QY	D1.16
PV14-10LFX-C	D1.26	PV18-4RNB-3K	D1.105	PV8-14R-QY	D1.15
PV14-10R-C	D1.10	PV18-4RX-CY	D1.11	PV8-14RX-QY	D1.16
PV14-10RB-3K	D1.105	PV18-56R-CY	D1.10	PV8-38R-QY	D1.15
PV14-10RX-C	D1.11	PV18-56RB-2K	D1.105	PV8-38RX-QY	D1.16
PV14-10SLF-C	D1.27	PV18-56RX-CY	D1.11	PV8-56R-QY	D1.15
PV14-10SLFB-3K	D1.113	PV18-5SLF-CY	D1.27	PV8-56RX-QY	D1.16
PV14-12R-L	D1.10	PV18-5SLFB-3K	D1.113	PV8-8R-QY	D1.15
PV14-14F-C	D1.23	PV18-610R-CY	D1.12	PV8-8RX-QY	D1.16
PV14-14FB-3K	D1.109	PV18-610RB-3K	D1.105	PVL100BY-0	E5.34
PV14-14R-C	D1.10	PV18-6F-CY	D1.23	PVL100BY-0-Y	E5.34
PV14-14RB-3K	D1.105	PV18-6FB-3K	D1.109	PVL100BY-1	E5.34
PV14-14RX-C	D1.11	PV18-6FF-CY	D1.28	PVL100BY-1-Y	E5.34
PV14-14SLF-C	D1.27	PV18-6FFB-3K	D1.114	PVL100BY-9	E5.34
PV14-14SLFB-3K	D1.113	PV18-6FN-CY	D1.23	PVL100BY-9-Y	E5.34
PV14-38R-L	D1.10	PV18-6FNB-3K	D1.109	PVL100BY-A	E5.34
PV14-38RB-2K	D1.105	PV18-6FX-CY	D1.24	PVL100BY-A-Y	E5.34
PV14-38RX-L	D1.11	PV18-6LF-CY	D1.25	PVL100BY-DSH	E5.34
PV14-4R-C	D1.10	PV18-6LFB-3K	D1.111	PVL100BY-DSH-Y	E5.34
PV14-4RB-3K	D1.105	PV18-6LFW-CY	D1.25	PVL100BY-Z	E5.34
PV14-4RX-C	D1.11	PV18-6LFWB-3K	D1.111	PVL100BY-Z-Y	E5.34
PV14-56R-C	D1.10	PV18-6LFX-CY	D1.26	PVL200BY-0	E5.34
PV14-56RB-2K	D1.105	PV18-6R-CY	D1.10	PVL200BY-0-Y	E5.34
PV14-56RX-C	D1.11	PV18-6RB-3K	D1.105	PVL200BY-1	E5.34
PV14-5SLF-C	D1.27	PV18-6RNB-3K	D1.105	PVL200BY-1-Y	E5.34
PV14-610R-C	D1.12	PV18-6RX-CY	D1.11	PVL200BY-9	E5.34
PV14-610RB-3K	D1.105	PV18-6SLF-CY	D1.27	PVL200BY-9-Y	E5.34
PV14-6F-C	D1.23	PV18-6SLFB-3K	D1.113	PVL200BY-A	E5.34
PV14-6FB-3K	D1.109	PV18-8F-CY	D1.23	PVL200BY-A-Y	E5.34
PV14-6FF-C	D1.28	PV18-8FB-3K	D1.109	PVL200BY-DSH	E5.34
PV14-6FFB-3K	D1.114	PV18-8FF-CY	D1.28	PVL200BY-DSH-Y	E5.34
PV14-6FN-C	D1.23	PV18-8FFB-3K	D1.114	PVL200BY-Z	E5.34
PV14-6FNB-3K	D1.109	PV18-8FX-CY	D1.24	PVL200BY-Z-Y	E5.34
PV14-6FX-C	D1.24	PV18-8LF-CY	D1.25	PW100F-C	C3.2
PV14-6LF-C	D1.25	PV18-8LFB-3K	D1.111	PW100F-C20	C3.2

A. System Overview
B1. Cable Ties
B2. Cable Accessories
B3. Stainless Steel Ties
C1. Wiring Duct
C2. Surface Raceway
C3. Abrasion Protection
C4. Cable Management
D1. Terminals
D2. Power Connectors
D3. Grounding Connectors
E1. Labeling Systems
E2. Labels
E3. Pre-Printed & Write-On Markers
E4. Permanent Identification
E5. Lockout/Tagout & Safety Solutions
F. Index

PANDUIT® ELECTRICAL SOLUTIONS

A. System Overview	Part Number	Page Number	Part Number	Page Number	Part Number	Page Number
B1. Cable Ties	PW100FR-C	C3.2	RSC4-6-L	D2.106	S100X125VADY	E2.20
	PW100FR-C20	C3.2	RSC4/0-1/0-X	D2.106	S100X125VAFY	E3.11
	PW150F-L	C3.2	RSC4/0-2/0-X	D2.106	S100X125VARY	E3.11
	PW150F-L20	C3.2	RSC4/0-4-X	D2.106	S100X125VATY	E2.7
	PW150F-Q	C3.2	RSC4/0-6-X	D2.106	S100X125YAJ	E2.2
	PW150F-Q20	C3.2	RSC500-X350-6	D2.106	S100X150TAD	E2.20
	PW150FR-L	C3.2	RSC500-X4/0-6	D2.106	S100X150TAT	E2.7
	PW150FR-L20	C3.2	RSC750-4/0-6	D2.107	S100X150V0TY	E2.7
	PW150FR-Q	C3.2	RSC750-500-6	D2.107	S100X150V9TY	E2.7
	PW150FR-Q20	C3.2	RSC750-750-6	D2.107	S100X150VA1Y	E2.7
B2. Cable Accessories	PW50F-T	C3.2	RSC750-X350-6	D2.107	S100X150VAC	E1.4
	PW50F-T20	C3.2	RSC750-X4/0-6	D2.107	S100X150VADY	E2.20
	PW50FR-T	C3.2	RSC750-X500-6	D2.107	S100X150VATY	E2.7
	PW50FR-T20	C3.2	RSCK1/0-4-1	D2.104	S100X150VBC	E1.4
	PW75F-C	C3.2	RSCK1/0-6-1	D2.104	S100X150VBTY	E2.7
	PW75F-C20	C3.2	RSCK2-4-1	D2.104	S100X150VCTY	E2.7
	PW75FR-C	C3.2	RSCK2-6-1	D2.104	S100X150VDC	E1.4
	PW75FR-C20	C3.2	RSCK2/0-4-1	D2.104	S100X150VDTY	E2.7
	PWMS-H25-C	B2.18	RSCK2/0-6-1	D2.104	S100X150VETY	E2.7
	PWMS-H25-M0	B2.18	RSCK4-6-1	D2.104	S100X150VFTY	E2.7
C1. Wiring Duct	PWT100	C3.2	RSCK4/0-1/0-1	D2.105	S100X150VGTY	E2.7
	PWT150	C3.2	RSCK4/0-2/0-1	D2.105	S100X150VHC	E1.4
	PWT50	C3.2	RSCK4/0-4-1	D2.104	S100X150VHTY	E2.7
	PWT75	C3.2	RSCK4/0-6-1	D2.104	S100X150VIC	E1.4
	PX-0	B1.51, B2.28	RSCK500-X350-1	D2.105	S100X150VITY	E2.7
	PX-10	B1.51, B2.28	RSCK500-X4/0-1	D2.105	S100X150YAJ	E2.2
	PX-2	B1.51, B2.28	RSCK750-4/0-1	D2.105	S100X225TAD	E2.21
			RSCK750-500-1	D2.105	S100X225TAT	E2.7
			RSCK750-750-1	D2.105	S100X225V0TY	E2.8
			RSCK750-X350-1	D2.105	S100X225V9TY	E2.8
C2. Surface Raceway			RSCK750-X4/0-1	D2.105	S100X225VA1Y	E2.7
			RSCK750-X500-1	D2.105	S100X225VAC	E1.4
			RSCKX750-4/0-1	D2.105	S100X225VADY	E2.21
			RSCKX750-750-1	D2.105	S100X225VAFY	E3.11
			RSCX750-4/0-3	D2.107	S100X225VARY	E3.11
			RSCX750-750-3	D2.107	S100X225VATY	E2.7
			RT1HT	B3.15	S100X225VBC	E1.4
			RT1HTN	B3.15	S100X225VBTY	E2.7
					S100X225VCTY	E2.7
					S100X225VDC	E1.4
C3. Abrasion Protection					S100X225VDTY	E2.8
					S100X225VETY	E2.8
					S100X225VFTY	E2.8
					S100X225VGTY	E2.8
					S100X225VHC	E1.4
					S100X225VHTY	E2.8
					S100X225VIC	E1.4
					S100X225VITY	E2.8
					S100X225VJTY	E2.2
					S100X400TAD	E2.21
C4. Cable Management					S100X400VADY	E2.21
					S100X400VATY	E2.8
					S100X400YAJ	E2.2
					S100X650TAD	E2.21
					S100X650VA1Y	E2.8
					S100X650VAC	E1.4
					S100X650VADY	E2.21
					S100X650VATY	E2.8
					S100X650YAJ	E2.2
					S150X150VATY	E2.8
D1. Terminals					S150X225VATY	E2.8
					S150X400VATY	E2.8
					S1F-C	C1.31
					S2-10R-X	D1.20
					S2-12R-X	D1.20
					S2-14R-X	D1.20
					S2-38R-X	D1.20
					S2-56R-X	D1.20
					S2/0-12R-X	D1.20
					S2/0-14R-X	D1.20
D2. Power Connectors					S2/0-38R-X	D1.20
					S2/0-56R-X	D1.20
					S2/0-76R-X	D1.20
					S200X225TAD	E2.21
					S200X225VA1Y	E2.8
					S200X225VADY	E2.21
					S200X225VATY	E2.8
					S200X225YAJ	E2.2
					S200X400TAD	E2.21
					S200X400TAT	E2.8
D3. Grounding Connectors					S200X400VA1Y	E2.8
					S200X400VADY	E2.21
					S200X400VATY	E2.8
					S100X075TAD	E2.20
					S100X075TAT	E2.7
					S100X075VA1Y	E2.7
					S100X075VAC	E1.4
					S100X075VADY	E2.20
					S100X075VADY	E2.20
					S100X075VATY	E2.7
E1. Labeling Systems					S100X075YAJ	E2.2
					S075X075VAC	E1.4
					S075X075VATY	E2.6
					S075X075YAJ	E2.2
					S075X100VAC	E1.4
					S075X125VAC	E1.4
					S075X125VATY	E2.6
					S075X125YAJ	E2.2
					S075X150VAC	E1.4
					S075X150VATY	E2.7
E2. Labels					S075X150YAJ	E2.2
					S1.5F-C	C1.31
					S1/0-12R-X	D1.20
					S1/0-14R-X	D1.20
					S1/0-38R-X	D1.20
					S1/0-56R-X	D1.20
					S100X075TAD	E2.20
					S100X075VAC	E1.4
					S100X075VADY	E2.20
					S100X075VATY	E2.7
E3. Pre-Printed & Write-On Markers					S100X125TAD	E2.7
					S100X125TAT	E2.7
					S100X125VA1	E2.7
					S100X125VA1Y	E2.7
					S100X125VAC	E1.4
					S100X125VADY	E2.20
					S100X125VATY	E2.7
					S100X125VCTY	E2.7
					S100X125VDC	E1.4
					S100X125VDTY	E2.7
E4. Permanent Identification					S100X125VETY	E2.7
					S100X125VFTY	E2.7
					S100X125VGTY	E2.7
					S100X125VHC	E1.4
					S100X125VHTY	E2.8
					S100X125VIC	E1.4
					S100X125VITY	E2.8
					S100X125VJTY	E2.2
					S100X125VVC	E1.4
					S100X125VVC	E1.4
E5. Lockout/Tagout & Safety Solutions					S100X125VDC	E1.4
					S100X125VDTY	E2.7
					S100X125VETY	E2.7
					S100X125VFTY	E2.7
					S100X125VGTY	E2.7
					S100X125VHC	E1.4
					S100X125VHTY	E2.8
					S100X125VIC	E1.4
					S100X125VITY	E2.8
					S100X125VJTY	E2.2
F. Index					S100X125VVC	E1.4
					S100X125VVC	E1.4
					S100X125VVC	E1.4
					S100X125VVC	E1.4
					S100X125VVC	E1.4
					S100X125VVC	E1.4
					S100X125VVC	E1.4
					S100X125VVC	E1.4
					S100X125VVC	E1.4
					S100X125VVC	E1.4

PANDUIT® ELECTRICAL SOLUTIONS

Part Number	Page Number	Part Number	Page Number	Part Number	Page Number
S200X400YAJ	E2.2	SBC8L-C	D2.131	SCSF4/0-X	D2.103
S200X650TAD	E2.21	SBCT10-C	D2.132	SCSF6-L	D2.103
S200X650VA1Y	E2.8	SBCT1/0-L	D2.132	SCSF8-L	D2.103
S200X650VADY	E2.21	SBCT1000-1	D2.132	SCSS1-Q	D2.59
S200X650VATY	E2.8	SBCT2-C	D2.132	SCSS1/0-X	D2.59
S200X650YAJ	E2.2	SBCT2/0-Q	D2.132	SCSS2-Q	D2.59
S250-12R-5	D1.20	SBCT250-Q	D2.132	SCSS2/0-X	D2.59
S250-38R-5	D1.20	SBCT3-C	D2.132	SCSS250-X	D2.59
S250-56R-5	D1.20	SBCT3/0-Q	D2.132	SCSS3/0-X	D2.59
S250-76R-5	D1.20	SBCT350-1	D2.132	SCSS4-L	D2.59
S2F-C	C1.31	SBCT500-1	D2.132	SCSS4/0-X	D2.59
S2X2YL6NM	C1.56	SBCT6-C	D2.132	SCSS6-L	D2.59
S3/0-12R-5	D1.20	SBCT750-1	D2.132	SCSS8-L	D2.59
S3/0-14R-5	D1.20	SBCT8-C	D2.132	SCT1/0-1/0	D2.63
S3/0-38R-5	D1.20	SCH1-E	D2.62	SCT2-2	D2.63
S3/0-56R-5	D1.20	SCH1/0-X	D2.62	SCT2/0-2/0	D2.63
S3/0-76R-5	D1.20	SCH1000-3	D2.62	SCT250-250	D2.63
S3F-C	C1.31	SCH2-Q	D2.62	SCT300-300	D2.63
S4-10R-E	D1.20	SCH2/0-X	D2.62	SCT350-350	D2.63
S4-14R-E	D1.20	SCH250-X	D2.62	SCT4/0-1/0	D2.63
S4-38R-E	D1.20	SCH3/0-X	D2.62	SCT4/0-4/0	D2.63
S4-56R-E	D1.20	SCH300-X	D2.62	SCT500-4/0	D2.63
S4/0-12R-5	D1.20	SCH350-X	D2.62	SCT500-500	D2.63
S4/0-38R-5	D1.20	SCH4-L	D2.62	SD2H6	C1.26
S4/0-56R-5	D1.20	SCH4/0-X	D2.62	SD2HWH6	C1.26
S4/0-76R-5	D1.20	SCH500-6	D2.62	SD3H6	C1.26
S4F-C	C1.31	SCH6-L	D2.62	SD3HWH6	C1.26
S4X4YL6NM	C1.56	SCH750-6	D2.62	SD4H6	C1.26
S6-10R-E	D1.20	SCL1-E	D2.61	SD4HWH6	C1.26
S6-14R-E	D1.20	SCL1/0-X	D2.61	SE125P-LR0	C3.13
S6-38R-E	D1.20	SCL1000-3	D2.61	SE125P-LR8	C3.13
S6-56R-E	D1.20	SCL2-Q	D2.61	SE125P-TR0	C3.13
S8-10R-Q	D1.20	SCL2/0-X	D2.61	SE125P-TR10	C3.13
S8-14R-Q	D1.20	SCL250-X	D2.61	SE125P-TR8	C3.13
S8-38R-Q	D1.20	SCL3/0-X	D2.61	SE125PFR-LR0	C3.14
S8-56R-Q	D1.20	SCL300-X	D2.61	SE125PFR-LR8	C3.14
SA1-X	D2.119	SCL350-X	D2.61	SE125PFR-TR0	C3.14
SA1/0-X	D2.119	SCL4-L	D2.61	SE125PFR-TR10	C3.14
SA1000-1	D2.119	SCL4/0-X	D2.61	SE125PFR-TR8	C3.14
SA2-X	D2.119	SCL400-6	D2.61	SE125PSC-LR0	C3.15
SA2/0-5	D2.119	SCL500-6	D2.61	SE12P-MR0	C3.13
SA250-5	D2.119	SCL6-L	D2.61	SE12P-MR10	C3.13
SA3/0-5	D2.119	SCL600-6	D2.61	SE12P-MR8	C3.13
SA300-2	D2.119	SCL750-6	D2.61	SE12P-TR0	C3.13
SA350-2	D2.119	SCL8-L	D2.61	SE12P-TR8	C3.13
SA4-X	D2.119	SCMS10-C	D2.112	SE12PFR-MR0	C3.14
SA4/0-5	D2.119	SCMS120-Q	D2.112	SE12PFR-MR10	C3.14
SA400-2	D2.119	SCMS150-X	D2.112	SE12PFR-MR8	C3.14
SA500-2	D2.119	SCMS16-C	D2.112	SE12PFR-TR0	C3.14
SA6-X	D2.119	SCMS185-X	D2.112	SE12PFR-TR8	C3.14
SA600-2	D2.119	SCMS240-X	D2.112	SE12PSC-TR0	C3.15
SA750-1	D2.119	SCMS25-L	D2.112	SE150P-LR0	C3.13
SA800-1	D2.119	SCMS300-5	D2.112	SE150P-LR8	C3.13
SACS50-T100	B1.54, B2.27	SCMS35-L	D2.112	SE150P-TR0	C3.13
SAR1/0-2-X	D2.120	SCMS400-5	D2.112	SE150P-TR10	C3.13
SAR2-4-X	D2.120	SCMS50-L	D2.112	SE150P-TR8	C3.13
SAR3/0-1/0-5	D2.120	SCMS500-6	D2.112	SE150PFR-LR0	C3.14
SAR350-4/0-2	D2.120	SCMS630-6	D2.112	SE150PFR-LR8	C3.14
SAR4/0-2/0-5	D2.120	SCMS70-L	D2.112	SE150PFR-TR0	C3.14
SAR500-350-2	D2.120	SCMS95-Q	D2.112	SE150PFR-TR10	C3.14
SAR600-500-2	D2.120	SCS1-E	D2.60	SE150PFR-TR8	C3.14
SAR750-600-2	D2.120	SCS1/0-X	D2.60	SE150PSC-LR0	C3.15
SBA1/0-Q	D2.133	SCS1000-3	D2.60	SE175P-TR0	C3.13
SBA2-C	D2.133	SCS2-Q	D2.60	SE175PFR-TR0	C3.14
SBA2/0-Q	D2.133	SCS2/0-X	D2.60	SE25P-MR0	C3.13
SBA350-1	D2.133	SCS250-X	D2.60	SE25P-MR10	C3.13
SBA4-C	D2.133	SCS3/0-X	D2.60	SE25P-MR8	C3.13
SBA4/0-Q	D2.133	SCS300-X	D2.60	SE25P-TR0	C3.13
SBA500-1	D2.133	SCS350-X	D2.60	SE25P-TR8	C3.13
SBA6-C	D2.133	SCS4-L	D2.60	SE25PFR-MR0	C3.14
SBC1/0-L	D2.131	SCS4/0-X	D2.60	SE25PFR-MR10	C3.14
SBC1000-1	D2.131	SCS400-6	D2.60	SE25PFR-MR8	C3.14
SBC2-C	D2.131	SCS500-6	D2.60	SE25PFR-TR0	C3.14
SBC2L-3	D2.131	SCS6-L	D2.60	SE25PFR-TR8	C3.14
SBC2/0-Q	D2.131	SCS600-6	D2.60	SE25PSC-TR0	C3.15
SBC250-Q	D2.131	SCS750-6	D2.60	SE38P-MR0	C3.13
SCC3-C	D2.131	SCS8-L	D2.60	SE38P-MR10	C3.13
SBC3/0-Q	D2.131	SCSF1-X	D2.103	SE38P-MR8	C3.13
SBC350-1	D2.131	SCSF1/0-X	D2.103	SE38P-TR0	C3.13
SBC4S-C	D2.131	SCSF2-E	D2.103	SE38P-TR8	C3.13
SBC4SL-C	D2.131	SCSF2/0-X	D2.103	SE38PFR-MR10	C3.14
SBC500-1	D2.131	SCSF250-X	D2.103	SE38PFR-MR8	C3.14
SBC6S-C	D2.131	SCSF3/0-X	D2.103	SE38PSC-TR0	C3.15
SBC6SL-C	D2.131	SCSF300-6	D2.103	SE50P-CR0	C3.13
SBC750-1	D2.131	SCSF350-6	D2.103	SE50P-CR8	C3.13
SBC8-C	D2.131	SCSF4-L	D2.103	SE50P-DR0	C3.13

A. System Overview
B1. Cable Ties
B2. Cable Accessories
B3. Stainless Steel Ties
C1. Wiring Duct
C2. Surface Raceway
C3. Abrasion Protection
C4. Cable Management
D1. Terminals
D2. Power Connectors
D3. Grounding Connectors
E1. Labeling Systems
E2. Labels
E3. Pre-Printed & Write-On Markers
E4. Permanent Identification
E5. Lockout/Tagout & Safety Solutions
F. Index

PANDUIT® ELECTRICAL SOLUTIONS

A. System Overview	Part Number	Page Number	Part Number	Page Number	Part Number	Page Number
B1. Cable Ties	SE50P-DR10	C3.13	SNS37F-C	C1.31	SSC4H-S25-D0	B1.70
	SE50P-DR8	C3.13	SNS50F-C	C1.31	SSC4H-S25-D30	B1.70
	SE50PFR-CR0	C3.14	SNS62F-C	C1.31	SSC4H-S25-L	B1.70
	SE50PFR-CR8	C3.14	SNS75F-C	C1.31	SSC4S-S10-C	B1.70
	SE50PFR-DR0	C3.14	SP1-1/0-L	D3.17	SSC4S-S10-M0	B1.70
	SE50PFR-DR10	C3.14	SP1-1/0L-L	D3.17	SSM2S-C	B1.71
	SE50PFR-DR8	C3.14	SP1-2-C	D3.17	SSM2S-D0	B1.71
	SE50PSC-CR0	C3.15	SP1-2/0-Q	D3.17	SSM4S-D	B1.71
	SE75P-CR0	C3.13	SP1-2/0L-Q	D3.17	SSPM2.5H-L300	B1.79
	SE75P-CR8	C3.13	SP1-2L-C	D3.17	SSPM2.5HP-L300	B1.79
B2. Cable Accessories	SE75P-DR0	C3.13	SP1-3-C	D3.17	SSPM4H-L300	B1.79
	SE75P-DR10	C3.13	SP1-350-12	D3.17	SSPM4HLP-TL300	B1.79
	SE75P-DR8	C3.13	SP1-350L-12	D3.17	SSPM4HP-L300	B1.79
	SE75PFR-CR0	C3.14	SP1-3L-C	D3.17	SST1.5I-C	B1.67
	SE75PFR-CR8	C3.14	SP1-4-C	D3.17	SST1.5I-M0	B1.68
	SE75PFR-DR0	C3.14	SP1-4/0-Q	D3.17	SST1.5M-C	B1.67
	SE75PFR-DR10	C3.14	SP1-4/0L-Q	D3.17	SST1.5M-M0	B1.68
	SE75PFR-DR8	C3.14	SP1-4L-C	D3.17	SST1.5M-M30	B1.69
	SE75PSC-CR0	C3.15	SP1-500-12	D3.17	SST1.5S-M	B1.67
	B3. Stainless Steel Ties	SEZ-1CLL	E5.38	SP1-500L-12	D3.17	SST1.5S-M0
SEZ-1DLL		E5.38	SP1-7-C	D3.17	SST1M-C	B1.67
SEZ-1NLL		E5.38	SP1-7L-C	D3.17	SST1M-C0	B1.68
SEZ-1WHLL		E5.38	SP1-8-C	D3.17	SST1M-M30	B1.69
SEZ-1WLL		E5.38	SP1-8L-C	D3.17	SST2H-D	B1.67
SEZ-1YLL		E5.38	SP2-1/0-L	D3.18	SST2H-D0	B1.68
SG100M-C		B1.40	SP2-1/0L-L	D3.18	SST2HH-D30	B1.69
SG100M-C0		B1.41	SP2-2-C	D3.18	SST2I-C	B1.67
SG150I-C		B1.40	SP2-2/0-Q	D3.18	SST2I-M0	B1.68
SG150I-C0		B1.41	SP2-2/0L-Q	D3.18	SST2S-C	B1.67
C1. Wiring Duct	SG200S-C	B1.40	SP2-2L-C	D3.18	SST2S-C0	B1.68
	SG200S-C0	B1.41	SP2-3-C	D3.18	SST2S-M30	B1.69
	SG200S-M30	B1.41	SP2-350-12	D3.18	SST3I-C	B1.67
	SG250S-C	B1.40	SP2-350L-12	D3.18	SST3I-C0	B1.68
	SG250S-C0	B1.41	SP2-3L-C	D3.18	SST3S-C	B1.67
	SG300S-C	B1.40	SP2-4-C	D3.18	SST3S-C0	B1.68
	SG300S-C0	B1.41	SP2-4/0-Q	D3.18	SST3S-M30	B1.69
	SG300S-M30	B1.41	SP2-4/0L-Q	D3.18	SST4H-D30	B1.69
	SG350LH-L	B1.40	SP2-4L-C	D3.18	SST4H-L	B1.67
	SG350LH-L0	B1.41	SP2-500-12	D3.18	SST4H-L0	B1.68
C2. Surface Raceway	SG350LH-TL30	B1.41	SP2-500L-12	D3.18	SST4HH-D30	B1.69
	SG370S-C	B1.40	SP2-7-C	D3.18	SST4I-C	B1.67
	SG370S-C0	B1.41	SP2-7L-C	D3.18	SST4I-M0	B1.68
	SG450H-L	B1.40	SP2-8-C	D3.18	SST4S-C	B1.67
	SG450H-L0	B1.41	SP2-8L-C	D3.18	SST4S-C0	B1.68
	SGABM20-A-C	B2.5	SPF1-1/0-L	D3.19	SST4S-M30	B1.69
	SGABM20-AT-C0	B2.5	SPF1-2-C	D3.19	SST8H-D30	B1.69
	SGABM25-A-C	B2.5	SPF1-2/0-Q	D3.19	SST8H-L	B1.67
	SGABM25-AT-C0	B2.5	SPF1-3-C	D3.19	SST8H-L0	B1.68
	SGABM25-S6-C	B2.5	SPF1-350-12	D3.19	ST2MT	B3.15
C3. Abrasion Protection	SGABM25-S6-C0	B2.5	SPF1-4-C	D3.19	ST3EH	B1.110
	SGABM30-A-C	B2.5	SPF1-4/0-Q	D3.19	STH2	B1.110
	SGABM30-AT-C0	B2.5	SPF1-500-12	D3.19	STHV	B1.110
	SGABM40-A-L	B2.5	SPF1-7-C	D3.19	STK12	E4.6
	SGABM40-AT-L0	B2.5	SPF1-8-C	D3.19	STS2	B1.110
	SGABM50-A-L	B2.5	SPF2-1/0-L	D3.20		
	SGABM50-AT-L0	B2.5	SPF2-2-C	D3.20		
	SGMPMH38-LO	B2.20	SPF2-2/0-Q	D3.20		
	SGMPMS19-C0	B2.20	SPF2-3-C	D3.20		
	SGMPMS25-C0	B2.20	SPF2-350-12	D3.20		
C4. Cable Management	SGMPMWH32-LO	B2.20	SPF2-4-C	D3.20		
	SGTA1S8-C	B2.12	SPF2-4/0-Q	D3.20		
	SGTM1S6-C	B2.14	SPF2-500-12	D3.20		
	SGTM1S6-C0	B2.14	SPF2-7-C	D3.20		
	SGTM2S8-C	B2.14	SPF2-8-C	D3.20		
	SGTM2S8-C0	B2.14	SR-0-XY	D2.154		
	SGTM3S10-C	B2.14	SR-1000-1Y	D2.154		
	SGTM3S10-C0	B2.14	SR-2-XY	D2.154		
	SHH1-S8-X	B2.50	SR-250-XY	D2.154		
	SHH3-S8-X	B2.50	SR-350-XY	D2.154		
D1. Terminals	SICH100-C	B2.43	SR-4/0-XY	D2.154		
	SICH150-C	B2.43	SR-500-3Y	D2.154		
	SICH25-C	B2.43	SR-750-1Y	D2.154		
	SICH38-C	B2.43	SR2	B1.83, D1.37		
	SICH50-C	B2.43	SR4	D1.37		
	SICH75-C	B2.43	SR6	D1.37		
	SMS-A-C	B2.6	SRT	C2.83		
	SMS-A-C14	B2.6	SS-1	D3.49		
	SMS-A-C15	B2.6	SS-1GAGE	D3.49		
	SMS-S6-D	B2.6	SSB2S-C	B1.77		
D2. Power Connectors	SNS.5-C	C1.31	SSB2S-M0	B1.77		
	SNS.75-C	C1.31	SSB2S-M30	B1.77		
	SNS1-C	C1.31	SSC2S-S10-C	B1.70		
	SNS1.5-C	C1.31	SSC2S-S10-M0	B1.70		
	SNS2-C	C1.31	SSC2S-S10-M30	B1.70		
	SNS25F-C	C1.31	SSC2S-S6-C	B1.70		
	SNS3-C	C1.31	SSC2S-S6-M0	B1.70		
D3. Grounding Connectors						
E1. Labeling Systems						
E2. Labels						
E3. Pre-Printed & Write-On Markers						
E4. Permanent Identification						
E5. Lockout/Tagout & Safety Solutions						
F. Index						

T

T024X000FJC-BK	E1.9
T031X000FJC-BK	E1.9
T038X000FJC-BK	E1.9
T038X000VPC-BK	E1.10
T038X000VYC-WH	E1.10
T038X000YKC-BK	E1.10
T050X000CBC-BK	E1.5
T050X000VPC-BK	E1.10
T050X000VQC-BK	E1.10
T050X000VQC-WH	E1.10
T050X000VSC-BK	E1.10
T050X000VSC-WH	E1.10
T050X000VUC-BK	E1.10
T050X000VWC-BK	E1.10
T050X000VWC-WH	E1.10
T050X000VXC-BK	E1.10
T050X000VYC-WH	E1.10
T050X000YKC-BK	E1.10
T050X000YKC-WH	E1.10
T075X000VPC-BK	E1.10
T075X000YKC-BK	E1.10
T100F-C	C3.5
T100F-C0	C3.5
T100FR-C	C3.6
T100FR-C20	C3.6
T100N-C	C3.7
T100N-C0	C3.7
T100R-CY	C3.6
T100T-X	C3.7

PANDUIT® ELECTRICAL SOLUTIONS

Part Number	Page Number	Part Number	Page Number	Part Number	Page Number
T100X000CBC-BK	E1.5	T400X000VX1Y	E2.19	T70FH2IW	C2.52
T100X000VP1Y	E2.19	T400X000VY1Y	E2.19	T70FH4IW	C2.52
T100X000VPC-BK	E1.10	T400X000Y2T	E5.32	T70FSB	C2.40
T100X000VQ1Y	E2.19	T425X000YK1	E2.19	T70FV2IW	C2.52
T100X000VQC-BK	E1.10	T400X000YX1	E5.23	T70FV4IW	C2.52
T100X000VQC-WH	E1.10	T45BIW10	C2.48	T70HB-X	C2.40
T100X000VS1Y	E2.19	T45BIW10-A	C2.48	T70HB3-X	C2.40
T100X000VSC-BK	E1.10	T45BIW8	C2.48	T70HB3GFCI-X	C2.40
T100X000VSC-WH	E1.10	T45BIW8-A	C2.48	T70ICIW	C2.36
T100X000VU1Y	E2.19	T45CCIW-X	C2.49	T70KW2IW	C2.54
T100X000VUC-BK	E1.10	T45CIW10	C2.48	T70KW4IW	C2.54
T100X000VUC-WH	E1.10	T45CIW8	C2.48	T70L2IW	C2.55
T100X000VW1Y	E2.19	T45DW10	C2.48	T70L4IW	C2.55
T100X000VWC-BK	E1.10	T45DW8	C2.48	T70LV2IW	C2.55
T100X000VWC-WH	E1.10	T45ECIW	C2.49	T70LV4IW	C2.55
T100X000VX1Y	E2.19	T45EEIW	C2.49	T70N2IW	C2.56
T100X000VXC-BK	E1.10	T45HDBIW	C2.49	T70N4IW	C2.56
T100X000VXC-WH	E1.10	T45HEBIW	C2.49	T70NV2IW	C2.56
T100X000VY1Y	E2.19	T45HEGBIW	C2.49	T70NV4IW	C2.56
T100X000VYC-WH	E1.10	T45ICIW	C2.49	T70OCIW	C2.37
T100X000YKC-BK	E1.10	T45OCIW	C2.49	T70PGIW	C2.53
T100X000YKC-WH	E1.10	T45RAIW	C2.49	T70PGSIW	C2.53
T12F-C	C3.4	T45RLDIW	C2.49	T70PIW	C2.53
T12F-C0	C3.5	T45TD	C2.49	T70PNIW	C2.53
T12FR-C	C3.6	T45TIW	C2.49	T70PSIW	C2.53
T12FR-C20	C3.6	T45TRI	C2.49	T70RAIW	C2.36
T12N-C	C3.6	T45WC2IW	C2.49	T70S-X	C2.40
T12N-C0	C3.7	T45WCIW	C2.49	T70SDB-X	C2.26, C2.40, C2.101, C2.110
T12R-CY	C3.5	T45WR-X	C2.49	T70TD	C2.37
T12T-C	C3.7	T50F-C	C3.4	T70TIW	C2.37
T19F-C	C3.4	T50F-C0	C3.5	T70TRCIW	C2.37
T19F-C0	C3.5	T50F-C1	C3.4	T70TRI	C2.37
T19FR-C	C3.6	T50F-C10	C3.4	T70TRIW	C2.37
T19FR-C20	C3.6	T50F-C16	C3.5	T70WC2IW	C2.37
T19N-C	C3.6	T50F-C2	C3.5	T70WCIW	C2.37
T19N-C0	C3.7	T50F-C3Y	C3.5	T70WM40TRIW	C2.37
T19R-CY	C3.5	T50F-C4Y	C3.5	T70WR-X	C2.40
T19T-C	C3.7	T50F-C5	C3.5	T75F-C	C3.5
T200X000VP1Y	E2.19	T50F-C6	C3.5	T75F-C0	C3.5
T200X000VQ1	E2.19	T50F-C7	C3.5	T75FR-C	C3.6
T200X000VQ1Y	E2.19	T50F-C8	C3.5	T75FR-C20	C3.6
T200X000VS1Y	E2.19	T50F-X	C3.4	T75N-C	C3.7
T200X000VT1Y	E2.19	T50F-X0	C3.5	T75N-C0	C3.7
T200X000VU1Y	E2.19	T50FR-C	C3.6	T75R-CY	C3.6
T200X000VV1Y	E2.19	T50FR-C20	C3.6	T75T-X	C3.7
T200X000VW1Y	E2.19	T50N-C	C3.7	TA1S10-C	B2.12
T200X000VX1Y	E2.19	T50N-C0	C3.7	TA1S10-M0	B2.12
T200X000VY1Y	E2.19	T50R-CY	C3.5	TA1S8-C	B2.12
T200X000Y2T	E5.32	T50T-Q	C3.7	TA1S8-M0	B2.12
T200X000YK1	E2.19	T62F-C	C3.5	TA1S8-M30	B2.12
T225X000YK1	E2.19	T62F-C0	C3.5	TA1S8-M69	B2.12
T25F-C	C3.4	T62FR-C	C3.6	TA2-C	B2.13
T25F-C0	C3.5	T62FR-C20	C3.6	TA2-M	B2.13
T25F-C1	C3.4	T62N-C	C3.7	TAPC2-2/0-X	D2.123, D3.8
T25F-C10	C3.4	T62N-C0	C3.7	TAPC3/0-4/0-5	D2.123, D3.8
T25F-C16	C3.4	T62R-CY	C3.6	TAPC500-2	D2.123, D3.8
T25F-C2	C3.4	T62T-Q	C3.7	TC10-14-C100	B2.41
T25F-C3Y	C3.4	T702BCIW-X	C2.39	TC14-20-C100	B2.41
T25F-C4Y	C3.4	T702BIW10	C2.38	TC3-5-C100	B2.41
T25F-C5	C3.4	T702BIW8	C2.38	TC5-7-C100	B2.41
T25F-C6	C3.4	T702ECIW	C2.39	TC5X8-C100	B2.41
T25F-C7	C3.4	T702EEIW	C2.39	TC6X10-C100	B2.41
T25F-C8	C3.4	T702ICIW	C2.39	TC7-10-C100	B2.41
T25F-X0	C3.5	T702OCIW	C2.39	TC7X14-C100	B2.41
T25FR-C	C3.6	T702RAIW	C2.39	TC9X18-C100	B2.41
T25FR-C20	C3.6	T702TIW	C2.39	TDP42HY	E1.12
T25N-C	C3.6	T702TRI	C2.39	TDP43HY	E1.12
T25N-C0	C3.7	T702TRIW	C2.39	TDP43M-AC	E1.11
T25R-C20Y	C3.5	T702TRLIW	C2.39	TDP43M-CASE	E1.11
T25R-CY	C3.5	T70B1IW	C2.53	TDP43M-RS	E1.11
T25T-L	C3.7	T70B2IW	C2.53	TDP43MY	E1.11
T38F-C	C3.4	T70BCIW-X	C2.36	TDP46HY	E1.12
T38F-C0	C3.5	T70BFI	C2.37	TF10IW-X	C2.79
T38FR-C	C3.6	T70BFIW	C2.37	TF3IW-E	C2.79
T38FR-C20	C3.6	T70BH1IW	C2.53	TF5IW-E	C2.79
T38N-C	C3.6	T70BH2IW	C2.53	TFC10IW-X	C2.80
T38N-C0	C3.7	T70BIW10	C2.36	TFC3IW-X	C2.80
T38R-CY	C3.5	T70BIW8	C2.36	TFC5IW-X	C2.80
T400X000VP1Y	E2.19	T70CCIW-X	C2.25, C2.36, C2.39	TFX10IW-X	C2.81
T400X000VQ1	E2.19	T70CIW10	C2.24, C2.36, C2.38	TFX3IW-X	C2.81
T400X000VQ1Y	E2.19	T70CIW8	C2.24, C2.36, C2.38	TFX5IW-X	C2.81
T400X000VS1Y	E2.19	T70DB-X	C2.26, C2.40	TFXD10IW-X	C2.75
T400X000VT1Y	E2.19	T70DW10	C2.36, C2.38	TG70BCIW-X	C2.25
T400X000VU1Y	E2.19	T70DW8	C2.36, C2.38	TG70HB3-X	C2.26
T400X000VV1Y	E2.19	T70ECIW	C2.37	TG70HB3GFCI-X	C2.26
T400X000VW1Y	E2.19	T70EEIW	C2.37		

A. System Overview

B1. Cable Ties

B2. Cable Accessories

B3. Stainless Steel Ties

C1. Wiring Duct

C2. Surface Raceway

C3. Abrasion Protection

C4. Cable Management

D1. Terminals

D2. Power Connectors

D3. Grounding Connectors

E1. Labeling Systems

E2. Labels

E3. Pre-Printed & Write-On Markers

E4. Permanent Identification

E5. Lockout/Tagout & Safety Solutions

F. Index

PANDUIT® ELECTRICAL SOLUTIONS

A. System Overview	Part Number	Page Number	Part Number	Page Number	Part Number	Page Number	
B1. Cable Ties	TG70IW10	C2.24	TV105-12MY	C3.16	WR2-C	C1.28	
	TG70IW8	C2.24	TV105-1M20Y	C3.16	WR2H-C	C1.28	
	TG70WR-X	C2.26	TV105-1MY	C3.16	WR3-C	C1.28	
	TGBFI	C2.25	TV105-3M20Y	C3.16	WR4-C	C1.28	
	TGBFIW	C2.25	TV105-3MY	C3.16	WR5-C	C1.28	
	TGDW10	C2.24	TV105-6M20Y	C3.16	WRS-A-C10	C1.28	
	TGDW8	C2.24	TV105-6MY	C3.16	WS25-25-C	B2.42	
	TGECIW	C2.25	TWR-C	B2.41	WS25-50-C	B2.42	
	TGEEIW	C2.25	TWR-C0	B2.41	WS25-75-C	B2.42	
	TGFSB	C2.26			WS35-25-C	B2.42	
B2. Cable Accessories	TGCIW	C2.25	U			WS35-50-C	B2.42
	TGOCIW	C2.25	UCT3S-X0	B1.89	WS35-75-C	B2.42	
	TGRAIW	C2.25	UCT5S-X0	B1.89	WS50-25-C	B2.42	
	TGSICIW	C2.25	UCTGS1224-X	B1.89	WS50-50-C	B2.42	
	TGSOCIW	C2.25	UCTGSM5-X	B1.89	WS50-75-C	B2.42	
	TGTD	C2.25	UCTGSM6-X	B1.89	WS75-25-C	B2.42	
	TGTIW	C2.25	UGCTC3S-X0	B1.89	WS75-50-C	B2.42	
	TGTRIW	C2.25	UGCTC5S-X0	B1.89	WS75-75-C	B2.42	
	THM1SC-C	B1.120	UGTE3S-X0	B1.89			
	THM1SC-C30	B1.120	UGTE5S-X0	B1.89			
B3. Stainless Steel Ties	THMSP20-C	B1.121	V				
	THMSP20-C30	B1.121	VCC25-A-C	B2.36			
	THMSP20F-C	B1.121	VCC50-A-C	B2.36			
	THMSP20F-C30	B1.121	VSC.25-L	B2.42			
	THMSP25-C	B1.121	VSC.25-L100	B2.42			
	THMSP25-C30	B1.121	VT-0-Q	D2.133			
	THMSP25F-C	B1.121	VT-1-Q	D2.133			
	THMSP25F-C30	B1.121	VT-2-Q	D2.133			
	TJF-X	B2.48	VT3-12	D2.133			
	TM1A-C	B2.11	VT4-12	D2.133			
C1. Wiring Duct	TM1S4-C	B2.9	VT5-6	D2.133			
	TM1S4-M69	B1.14, B2.9	VT6-6	D2.133			
	TM1S6-M69	B1.14, B2.9	VTA-0-Q	D2.134			
	TM2A-C	B2.11	VTA-1-Q	D2.134			
	TM2PWH25-C	B2.18	VTA-2-Q	D2.134			
	TM2S6-C	B2.9	VTA-3-12	D2.134			
	TM2S6-M69	B1.14, B2.9	VTA-4-12	D2.134			
	TM2S8-C76	B1.19	VTA-5-6	D2.134			
	TM2S8-M69	B1.14, B2.9	VTA-6-6	D2.134			
	TM3-X2-C0Y	B2.11	VWS106-C	B2.44			
C2. Surface Raceway	TM3A-C	B2.11	VWS42105-C	B2.43			
	TM3S10-C76	B1.19	VWS4218-C	B2.43			
	TM3S10-M69	B1.14, B2.9	VWS4238-C	B2.43			
	TM3S8-C	B2.9	VWS4274-C	B2.43			
	TM3S8-C69	B1.14, B2.9	VWSDC-C	B2.44			
	TM3S8-C76	B1.19	W				
	TMC100X50BR2	C1.23	WB12-L	D3.25			
	TMC100X75BR2	C1.23	WB34-X	D3.25			
	TMC25X37BR2	C1.23	WB58-Q	D3.25			
	TMC37X37BR2	C1.23	WBS6-Q	B2.45			
TMC50DW2	C1.23, C1.27	WCM35BFIW	C2.91				
C3. Abrasion Protection	TMC50X50BR2	C1.23	WCM35BIW8	C2.90			
	TMC75DW2	C1.23, C1.27	WCM35CCIW-X	C2.91			
	TMC75X50BR2	C1.23	WCM35CIW8	C2.90			
	TMC75X75BR2	C1.23	WCM35DBFIW	C2.91			
	TMEH-S10-C100	B2.10	WCM35DW8	C2.90			
	TMEH-S10-C109	B2.10	WCM35ECIW	C2.91			
	TMEH-S10-Q0	B2.10	WCM35ICIW	C2.91			
	TMEH-S25-Q0	B2.10	WCM35OCIW	C2.91			
	TMEH-S8-Q0	B2.10	WCM35TI	C2.91			
	TMEH-X2-L0Y	B2.11	WCM35TIW	C2.91			
C4. Cable Management	TMSTHS10-D0	B2.12	WCM35TR10IW	C2.91			
	TMSTHS13-D0	B2.12	WCM35TR5IW	C2.91			
	TMSTHS16-D0	B2.12	WCM35TR70IW	C2.91			
	TMSTHS19-D0	B2.12	WCM35TRIW	C2.91			
	TMSTLHS6-M0	B2.12	WCM35WR-X	C2.91			
	TMSTLHS8-M0	B2.12	WEH-E8-C	B2.49			
	TNR	C1.34	WL1	E5.25			
	TP2-C	B2.15	WL25	E5.25			
	TP4H-C	B2.15	WL3	E5.25			
	TRC18FR-X8	C4.10	WL32	E5.25			
D1. Terminals	TRC2BL	C1.59	WL32Y	E5.25			
	TRC4BL	C1.59	WL33	E5.25			
	TTLK3	B1.112, B3.14	WL33Y	E5.25			
	TTS-20R0	B1.88	WL35	E5.25			
	TTS-35R3-0	B1.88	WL35Y	E5.25			
	TTS-35RX0	B1.88	WL36	E5.25			
	TV105-.38D20Y	C3.16	WL36Y	E5.25			
	TV105-.38DY	C3.16	WPMH-C	B2.21			
	TV105-.50D20Y	C3.16	WPS-20	C2.60			
	TV105-.50DY	C3.16	WPS-202	C2.60			
D2. Power Connectors	TV105-.75TL20Y	C3.16					
	TV105-.75TLY	C3.16					
	TV105-1.0C20Y	C3.16					
	TV105-1.0CY	C3.16					
	TV105-12M20Y	C3.16					
	D3. Grounding Connectors	TV105-38D20Y	C3.16				
		TV105-38DY	C3.16				
		TV105-50D20Y	C3.16				
		TV105-50DY	C3.16				
		TV105-.75TL20Y	C3.16				
TV105-.75TLY		C3.16					
TV105-1.0C20Y		C3.16					
TV105-1.0CY		C3.16					
TV105-12M20Y		C3.16					
E1. Labeling Systems		TV105-38D20Y	C3.16				
	TV105-38DY	C3.16					
	TV105-50D20Y	C3.16					
	TV105-50DY	C3.16					
	TV105-.75TL20Y	C3.16					
	TV105-.75TLY	C3.16					
	TV105-1.0C20Y	C3.16					
	TV105-1.0CY	C3.16					
	TV105-12M20Y	C3.16					
	E2. Labels	TV105-38D20Y	C3.16				
TV105-38DY		C3.16					
TV105-50D20Y		C3.16					
TV105-50DY		C3.16					
TV105-.75TL20Y		C3.16					
TV105-.75TLY		C3.16					
TV105-1.0C20Y		C3.16					
TV105-1.0CY		C3.16					
TV105-12M20Y		C3.16					
E3. Pre-Printed & Write-On Markers		TV105-38D20Y	C3.16				
	TV105-38DY	C3.16					
	TV105-50D20Y	C3.16					
	TV105-50DY	C3.16					
	TV105-.75TL20Y	C3.16					
	TV105-.75TLY	C3.16					
	TV105-1.0C20Y	C3.16					
	TV105-1.0CY	C3.16					
	TV105-12M20Y	C3.16					
	E4. Permanent Identification	TV105-38D20Y	C3.16				
TV105-38DY		C3.16					
TV105-50D20Y		C3.16					
TV105-50DY		C3.16					
TV105-.75TL20Y		C3.16					
TV105-.75TLY		C3.16					
TV105-1.0C20Y		C3.16					
TV105-1.0CY		C3.16					
TV105-12M20Y		C3.16					
E5. Lockout/Tagout & Safety Solutions		TV105-38D20Y	C3.16				
	TV105-38DY	C3.16					
	TV105-50D20Y	C3.16					
	TV105-50DY	C3.16					
	TV105-.75TL20Y	C3.16					
	TV105-.75TLY	C3.16					
	TV105-1.0C20Y	C3.16					
	TV105-1.0CY	C3.16					
	TV105-12M20Y	C3.16					
	F. Index	TV105-38D20Y	C3.16				
TV105-38DY		C3.16					
TV105-50D20Y		C3.16					
TV105-50DY		C3.16					
TV105-.75TL20Y		C3.16					
TV105-.75TLY		C3.16					
TV105-1.0C20Y		C3.16					
TV105-1.0CY		C3.16					
TV105-12M20Y		C3.16					

NOTES

A.
System
Overview

B1.
Cable Ties

B2.
Cable
Accessories

B3.
Stainless
Steel Ties

C1.
Wiring
Duct

C2.
Surface
Raceway

C3.
Abrasion
Protection

C4.
Cable
Management

D1.
Terminals

D2.
Power
Connectors

D3.
Grounding
Connectors

E1.
Labeling
Systems

E2.
Labels

E3.
Pre-Printed
& Write-On
Markers

E4.
Permanent
Identification

E5.
Lockout/
Tagout/
& Safety
Solutions

F.
Index

PANDUIT is a global leader in cabling and communication products, delivering end-to-end solutions in support of demanding electrical and networking requirements.

PANDUIT Catalogs

Network Connectivity

SA-NCCB46



- Cable
- Modules
- Work Area Outlet Solutions
- Surface Raceway
- Zone Cabling Systems
- Wireless Solutions
- Copper Patch Panels, Cords, and Punchdowns
- Fiber Connectors, Enclosures, and Patch Cords
- Overhead and Underfloor Routing Systems
- Cabinets, Racks, and Cable Management
- Grounding and Bonding
- Managed System Solutions
- Industrial
- Labeling and Identification
- Wiring Duct
- Cable Ties and Accessories

Searching by Part Numbers in this Catalog PDF

1. To search for a Part Number in this Catalog PDF, either press the Control key and the letter F (Ctrl-F) at the same time OR from the menu bar, select Edit, and then select Find/Change.

2. The screen will spit into two parts. In the first window on the right side, type in the part number you wish to find. For example, if you wish to find LCCF300-12H-6, type as shown. There is no need to be case sensitive in your typing.

3. When you are done typing, press the "Search" button.

If you want to be less precise in your search, and find all instances of similar part numbers, you could type in just part of the number. For example, if you want to find all the LCCF300 numbers, just type in LCCF300.

4. The right side of the screen, under "Results", will now display all occurrences of the part number. Select any of the choices to be taken to that page.

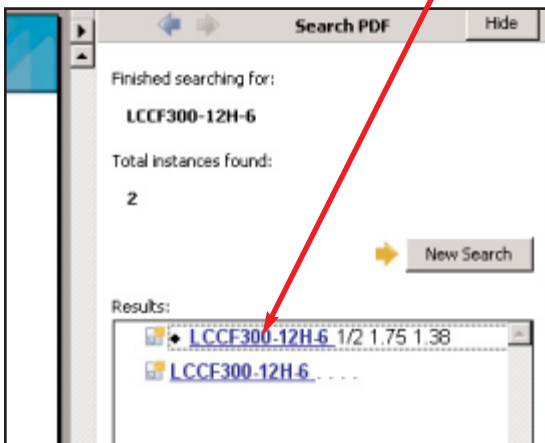
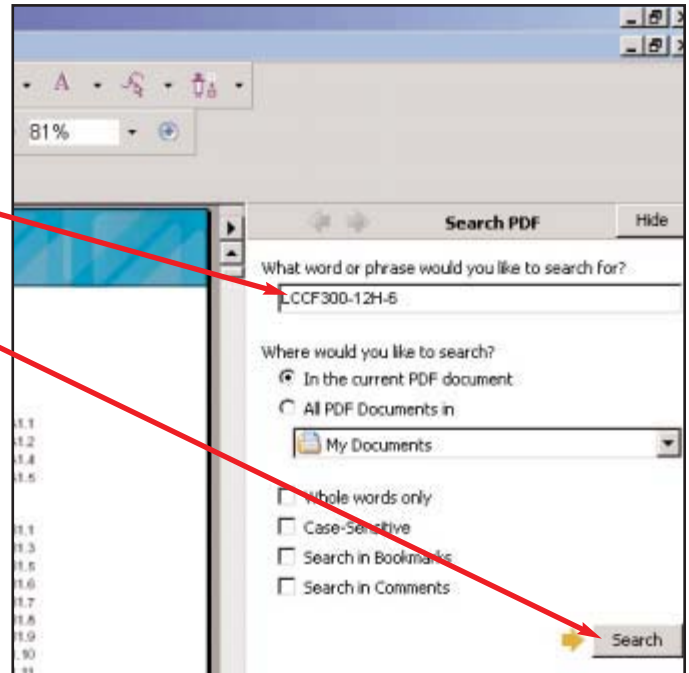

5. The left side of your screen will now show the page with the part number, and the part number will be highlighted (see below).

Part Number	Class K & M	Locomotive	W	B	T	L	Code		
LCCF40-14BH-X			1.14	0.75	1.17	1.81	14	5.06	Yellow
LCCF40-18DH-X			3.8	1.00	1.17	1.81	14	5.55	Yellow
LCCF40-18H-X	40 AWG	40 AWG	3.8	1.75	1.17	1.81	14	4.30	Yellow
LCCF40-12H-X			1.2	1.75	1.17	1.81	14	4.69	Yellow
LCCF250-14BH-X			1.14	0.75	1.28	2.24	17	5.88	White
LCCF250-38DH-X	250 kcmil	202.6 kcmil	3.8	1.00	1.28	2.24	17	4.14	White
LCCF250-12H-X			1.2	1.25	1.28	2.24	17	4.82	White
LCCF250-12H-X			1.2	1.75	1.28	2.24	17	5.32	White
LCCF300-14BH-E			1.14	0.75	1.38	2.30	18	5.77	Red
LCCF300-38DH-E	300 kcmil	313.1 kcmil	3.8	1.00	1.38	2.30	18	4.25	Red
LCCF300-12H-E			1.2	1.75	1.38	2.30	18	5.43	Red
LCCF350-14BH-E			1.14	0.75	1.55	2.50	22	5.98	Blue
LCCF350-38DH-E	350 kcmil	373.7 kcmil	3.8	1.00	1.55	2.50	22	4.46	Blue
LCCF350-12H-E			1.2	1.25	1.55	2.50	22	5.14	Blue
LCCF350-12H-E			1.2	1.75	1.55	2.50	22	5.64	Blue
LCCF400-38DH-E	400 kcmil	444.4 kcmil	3.8	1.00	1.70	2.69	26	4.99	Brown
LCCF400-12H-E			1.2	1.75	1.70	2.69	26	5.94	Brown
LCCF500-12H-E	500 kcmil	535.3 kcmil	1.2	1.75	1.89	2.88	26	6.16	Pink
LCCF600-12H-E		640.4 kcmil	1.2	1.75	1.95	2.94	29	6.25	Black
LCCF750-38DH-3			3.8	1.00	2.17	3.00	32	5.45	Orange
LCCF750-12H-3		777.7 kcmil	1.2	1.75	2.17	3.00	32	6.39	Orange

6. To return to a full screen view, select the "Hide" button. To keep the "Search PDF" screen and search for more part numbers, select the "New Search" button (see below).

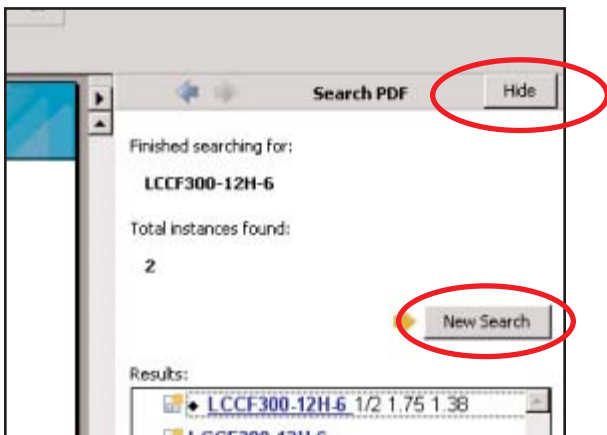

Note: An alternative is to look in the Part Number Index at the back of this PDF and find the part number manually, then manually scroll to the page indicated.

[Click Here to Return to the Table of Contents](#)

USER TIPS / HELP

- ▶ Acrobat Alert: "This file may contain newer..."
- ▶ Links not working, pop-up blocker
- ▶ Windows XP links not working, security alerts
- ▶ View with Browser or Reader Application
- ▶ Bookmarks: quick, easy table of contents
- ▶ Acrobat navigation Next / Previous buttons
- ▶ View facing pages
- ▶ Acrobat Search options

RETURN TO CATALOG

PROGRAM LINKS

Obtain programs that may be necessary to use content on this disc.

CONTACT US

Acrobat Alert "...may contain newer information than this viewer can support..."

When opening PDF documents on this disc, you may see this alert.



Check the **Do not show...** box and click OK. PDF files on this disc are formatted to be completely functional with Acrobat Reader version 5 or higher. As long as the PDF file opens, all required features will be available.

If you wish to upgrade to a newer version of Acrobat (now Adobe) Reader, click the Program Links button to the left.

[TOP](#)

Links not working (Pop-Up Blockers)

Some links will open a new browser window. If you have a pop-up blocker installed in your browser, it may see new linked windows as pop-ups. Setting the blocker to allow pop-ups from this site (CD) should resolve this problem.

[TOP](#)

Links not working / security alerts (Windows XP)

If you have installed Service Pack 2 (SP2) for Windows XP (Home or Professional) you are aware of the very high level of security enforced by the system. It is particularly aggressive in protecting you against "active links". Virtually every file on this CD has active links that allow you to move between pages and open other documents. As a result, some documents may seem to have links that don't work or pages that open blank. If this happens, look at the top of the web page for this alert:

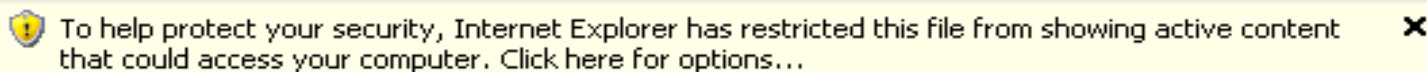

Allow Blocked Content...

What's the Risk?

Information Bar Help

[TOP](#)

USER TIPS / HELP

- ▶ Acrobat Alert: "This file may contain newer..."
- ▶ Links not working, pop-up blocker
- ▶ Windows XP links not working, security alerts
- ▶ View with Browser or Reader Application
- ▶ Bookmarks: quick, easy table of contents
- ▶ Acrobat navigation Next / Previous buttons
- ▶ View facing pages
- ▶ Acrobat Search options

RETURN TO CATALOG

PROGRAM LINKS

Obtain programs that may be necessary to use content on this disc.

CONTACT US

Adobe Reader Application or Browser Options

When you install Acrobat Reader, it installs both an Application (stand-alone program) and a plug-in for your browser program(s). By default it will be configured to open PDF files in your Internet browser. You may setup Acrobat to open documents in either your browser window or to open them in the standard Reader application window.

What's the Difference?

INTERNET BROWSER WINDOW	APPLICATION WINDOW
▶ Can have only one PDF Document open at a time	▶ Can have multiple documents open simultaneously
▶ Search may be limited by support provided at the site of the PDF file	▶ Support for full Search of the site/CD contents
▶ Potential security alert in Windows XP (SP2) everytime you link to a new document	▶ No Security alerts

This option can be easily changed in the Reader application. To open the application window, look for the Adobe icon on your Start menu or Desktop. This option can only be edited within the application. These instructions apply to version 5 through 7.

- Select Edit/Preferences
- From the list in the left pane select Internet
- Check "Display PDF in Browser" to have PDF file open in your Browser; uncheck it to have PDF files open in the Reader application.

[TOP](#)

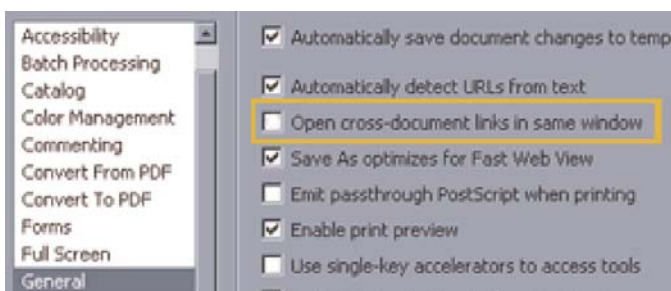
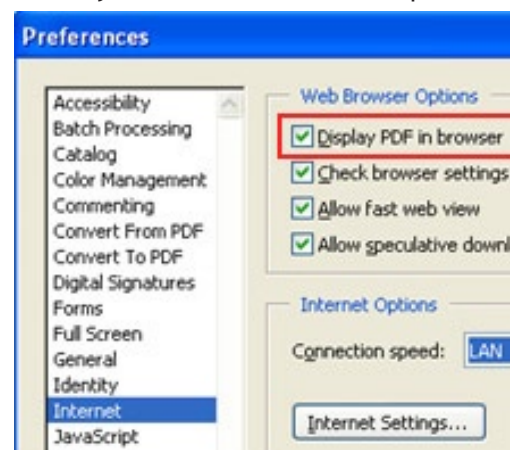

[TOP](#)

The Reader application offers you the option of having links between documents open to replace the original window or open as a new window. While in the Preferences area of Reader, select the General option in the left pane.

Default (checked) is to have links open in the same window. Uncheck "Open cross-document links in same window" if you prefer to have links open in a new window.

Adobe®, Acrobat® and Adobe Reader® are registered or registered tradenames of Adobe Systems, Inc. in the United States and other countries.

USER TIPS / HELP

- ▶ Acrobat Alert: "This file may contain newer..."
- ▶ Links not working, pop-up blocker
- ▶ Windows XP links not working, security alerts
- ▶ View with Browser or Reader Application
- ▶ Bookmarks: quick, easy table of contents
- ▶ Acrobat navigation Next / Previous buttons
- ▶ View facing pages
- ▶ Acrobat Search options

RETURN TO CATALOG

PROGRAM LINKS

Obtain programs that may be necessary to use content on this disc.

CONTACT US

Bookmarks - Hyper Table of Contents

In very large PDF files, Acrobat bookmarks become a much faster and more convenient than searching through massive Table of Content listings.

Bookmarks can be toggled on or off by selecting the appropriate tab on the left side of the page.

Bookmarks contain nested listings so you can locate major categories, then drill down to specific products types.

Click the "+" or "-" in front of the listing to expand or collapse a category.

Click on a bookmark link at any level to jump to that specific location.

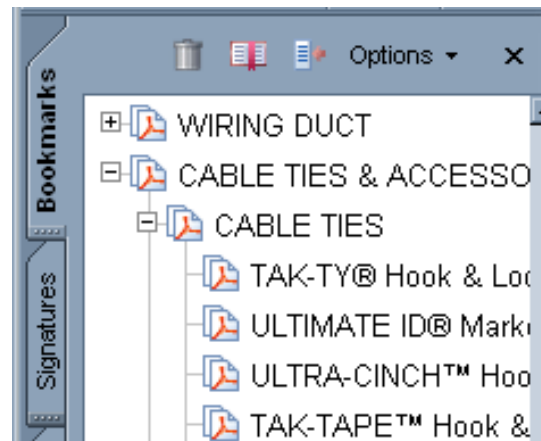

[TOP](#)

Navigation / Page View Options

Acrobat enhances your experience in PDF catalogs with two sets of navigation buttons. The arrow buttons work just like the Next and Previous buttons in a web browser.

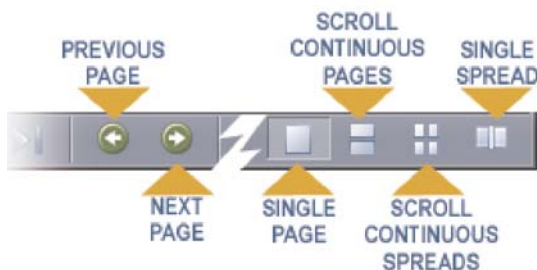

Page view buttons allow you to choose to view one page at a time or scroll so you can see portions of the bottom of one page and the top of the next.

Some pages, like Roadmaps in *PANDUIT* catalogs, are best viewed as spreads (side-by-side pages). You can choose this option with the page view buttons.

[TOP](#)

USER TIPS / HELP

- ▶ Acrobat Alert: "This file may contain newer..."
- ▶ Links not working, pop-up blocker
- ▶ Windows XP links not working, security alerts
- ▶ View with Browser or Reader Application
- ▶ Bookmarks: quick, easy table of contents
- ▶ Acrobat navigation Next / Previous buttons
- ▶ View facing pages
- ▶ Acrobat Search options

RETURN TO CATALOG

PROGRAM LINKS

Obtain programs that may be necessary to use content on this disc.

CONTACT US

Using Acrobat Find or Search

In Acrobat, Find and Search are distinct functions.

- Find scans the currently selected document for matches to your criteria
- Search can be configured to include one or multiple documents on a disc computer or server, then return results that appear in any of those documents.

Acrobat Version 6 or 7

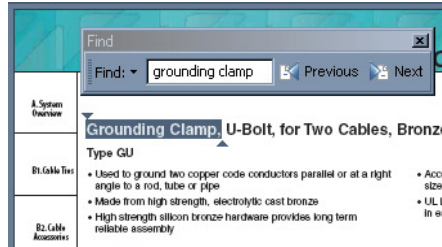

Find is accessed with the Ctrl+F key combo (Edit>Find). Type in the search criteria and click Next. If there are matches to your criteria, a page will appear with the results highlighted. Continuing to click Next or Previous changes pages and highlight locations.

Open **Search** by clicking the binocular button Search (Ctrl+Shift+F). The Search dialog offers the option of selecting locations to be included (1).

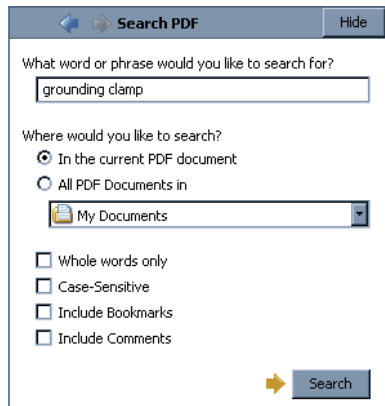

Enter your search criteria, click the search button.

TOP

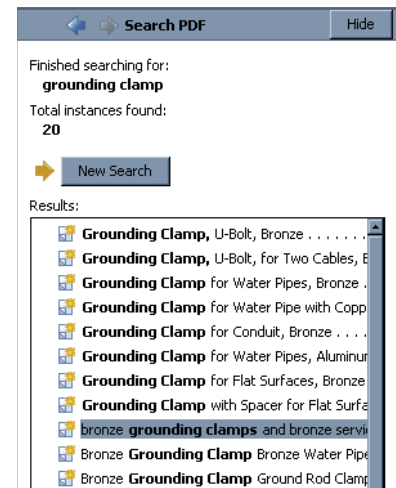

Results will appear as a list. Each item is an active link to that location in the document where it was found. Click a link to jump to that location.

TOP

USER TIPS / HELP

- ▶ Acrobat Alert: "This file may contain newer..."
- ▶ Links not working, pop-up blocker
- ▶ Windows XP links not working, security alerts
- ▶ View with Browser or Reader Application
- ▶ Bookmarks: quick, easy table of contents
- ▶ Acrobat navigation Next / Previous buttons
- ▶ View facing pages
- ▶ Acrobat Search options

RETURN TO CATALOG

PROGRAM LINKS

Obtain programs that may be necessary to use content on this disc.

CONTACT US

Optional Installation Programs & Links

PDF files on this optimized for use with Acrobat 5 or higher.

Installing Acrobat / Adobe Reader

If you don't already have Acrobat Reader, it is always recommended that you download the most current version from the Adobe website. Click the logo under Third Party Links (below) to go the the download page. The name of the program was changed from Acrobat Reader to Adobe Reader starting with Version 6.x. The version on this CD is 7.0.5 (U.S. English, Windows only) and is made available for those who do not have ready access to the internet. To install from this disc, browse the CD folders and open Programs.

Installation Cautions

Adobe strongly recommends that only one version of Reader be installed on any computer. Please uninstall previous versions before you install. Uninstalling a previous version after installing a newer one can also delete files required by the newer one.

Free Third Party Links (if needed)

PANDUIT Web sites, CDs and DVDs may contain multimedia programs that require your computer to have one or more of the following programs or plugins installed. Selecting a file or link requiring one of these programs will alert you of the program required. All these programs are free by way of the Internet links below. If you frequent the Internet, you probably already have some or all of these programs installed.

[TOP](#)



VISIO®, Windows®, 98SE®, Windows 2000® and Windows XP® are trademarks of Microsoft Corporation and may be registered in some jurisdictions.

Adobe® Acrobat® and Reader® are registered or registered tradenames of Adobe Systems, Inc. in the United States and other countries.

Macromedia®, Flash® and Shockwave® are trademarks of Macromedia, Inc.

USER TIPS / HELP

- ▶ Acrobat Alert: "This file may contain newer..."
- ▶ Links not working, pop-up blocker
- ▶ Windows XP links not working, security alerts
- ▶ View with Browser or Reader Application
- ▶ Bookmarks: quick, easy table of contents
- ▶ Acrobat navigation Next / Previous buttons
- ▶ View facing pages
- ▶ Acrobat Search options

RETURN TO CATALOG

PROGRAM LINKS

Obtain programs that may be necessary to use content on this disc.

CONTACT US

Visit PANDUIT on the Web

Get all the latest news about PANDUIT products, services, training and events. Locate distributors. View the always up-to-date online catalog, more downloadable PDF catalogs or request printed materials. Register for newsletters, designer/installer certification; enjoy special catalog features like Favorites and saved Bills of Material

Contact Information

PANDUIT® Corporate Headquarters (North America)

PANDUIT Corp.	Telephone	888-506-5400 / 708-532-1800
17301 Ridgeland Avenue	Fax	708-532-1811
Tinley Park, IL 60477-3091	eMail	cs@panduit.com
U.S.A.		

If connected, [click here](#) to view complete, current Sales Office information on our website. Current PANDUIT [warranty information](#) is available on our website.

PANDUIT Latin America Headquarters (Central and South America)

PANDUIT Latin America	Telephone	52 333 666 2501
Av. Lazaro Cardenas 2785	Fax	52 33 3666 2510
Col. Alamo Industrial	eMail	mkt@panduit.com.mx
Guadalajara , Jal 44490		
Mexico		

[TOP](#)

PANDUIT Europe Headquarters (Europe / Middle East / Africa)

PANDUIT Europe Ltd.	Telephone	44 20 8601 7200
West World	Fax	44 20 8601 7209
Westgate , London W5 1XP	eMail	cs@panduit.com
United Kingdom		

[TOP](#)

PANDUIT Aisa/Pacific Headquarters

PANDUIT Asia Pacific Pte. Ltd.	Telephone	65 6379 6700
60 Tuas Avenue 11	Fax	65 6379 6759
Singapore,	eMail	sgp-sales@panduit.com
Republic of Singapore 639106		

[TOP](#)